



Department
of Energy &
Climate Change

Electricity Market Reform: Consultation on Proposals for Implementation

October 2013





Electricity Market Reform: Consultation on Proposals for Implementation

Presented to Parliament
by the Secretary of State for Energy and Climate Change
by Command of Her Majesty

October 2013

Cm 8706

£38.75

© Crown copyright 2013

You may re-use this information (excluding logos) free of charge in any format or medium, under the terms of the Open Government Licence. To view this licence, visit <http://www.nationalarchives.gov.uk/doc/open-government-licence/> or e-mail: psi@nationalarchives.gsi.gov.uk.

Where we have identified any third party copyright information you will need to obtain permission from the copyright holders concerned.

Any enquiries regarding this publication should be sent to us at:

Department of Energy and Climate Change
3 Whitehall Place
London
SW1A 2AW

You can download this publication from <https://www.gov.uk/government/consultations/proposals-for-implementation-of-electricity-market-reform>

ISBN: 9780101870627

Printed in the UK by The Stationery Office Limited
on behalf of the Controller of Her Majesty's Stationery Office

ID P002585757 10/13

Printed on paper containing 75% recycled fibre content minimum.

Foreword



This Government has set out ambitious plans for reforming the electricity market. The Energy Bill, which is currently completing its passage through Parliament, creates a framework through which the UK can develop a clean, diverse and competitive mix of electricity generation that delivers security of supply and keeps bills as low as possible for consumers now and in the future.

At the heart of our strategy is affordable energy security that meets our climate change responsibilities. We need to attract the £110bn of private capital investment required in this decade alone to replace the old and dirty power stations that are going off line and move to cleaner low carbon energy. As it stands, the market is unlikely to deliver the investment in infrastructure necessary to achieve this at the scale and pace required.

This document sets out the detailed implementation package of Electricity Market Reform and is accompanied by illustrative draft statutory instruments. At the centre of the package lie two new investment mechanisms: Contracts for Difference (CfDs) and the Capacity Market. CfDs will stimulate investment in all forms of low-carbon energy generation by providing generators selling into the market with long-term price certainty – resulting in lower borrowing costs for suppliers and cheaper prices for consumers. The CfD also lowers risk by providing certainty in the form of a legally binding private law contract, backed by a robust flow of payments. The Capacity Market will deliver security of supply by providing generators with a steady retainer payment to be available to provide additional capacity when needed.

The investment that these reforms will unlock will help support up to 250,000 jobs in low carbon electricity generation by 2020, and strengthen economic growth. It will boost energy security by encouraging a more diverse portfolio of home-grown generation such as new nuclear power, onshore and offshore wind and solar. Investment will also lead to innovation and the development of competitive supply chains, set up to serve these thriving areas of the energy industry.

Providing certainty and long-term stability to suppliers will also help keep energy bills affordable. It's estimated that as a result of our reforms, average annual household electricity bills will be around 9%– or £63 per annum – lower over the period 2016 to 2030, than if we carried on without these reforms.

Ultimately these reforms will ensure the UK has security of supply and that the lights can stay on. They will keep bills as low as possible in a way which is sustainable, laying the groundwork for cleaner, more efficient energy well into the future. And they will help make sure that the UK becomes a world leader in the global race for secure, low carbon electricity generation.

A handwritten signature in black ink, appearing to read "Edward Davey". The signature is written in a cursive style with a long horizontal stroke at the end.

The Rt. Hon. Edward Davey MP

Secretary of State for Energy and Climate Change

Contents

General Information	8
Executive Summary	10
Chapter 1: Aims of the Consultation	18
Chapter 2: Implementing EMR	23
EMR design overview	23
How EMR will be implemented.....	23
Table 1.2: List of Statutory Instruments	40
Chapter 3: Implementing Contracts for Difference	42
Section 3.1: Introduction	44
Section 3.2: Narrative of Policy Framework.....	52
Section 3.3: Payment Model and Supplier obligation.....	86
Section 3.4: Implementing the CfD payment model.....	123
Section 3.5: Next Steps.....	129
Section 3.6: Summary of Contract for Difference Design Proposals.....	130
Chapter 4: Electricity Market Reform: Capacity Market – Detailed Design Proposals	134
Section 4.1: Introduction	137
Section 4.2: Narrative of policy framework	142
Section 4.3: Participation of demand side response (DSR), including embedded generation and smaller storage capacity.....	192
Section 4.4: Payment model	206
Section 4.5: Institutional and governance arrangements	225
Section 4.6: Legal Framework for the Capacity Market	230
Section 4.7: Ensuring the Capacity Market meets its objectives	239
Section 4.8: Capacity Market Units (CMUs) and pre-qualification requirements	244
Section 4.9: Summary of Capacity Market design proposals	251
Chapter 5: Ensuring effective and transparent delivery of EMR	254
Chapter 6: EMR in the Devolved Administrations	276
Chapter 7: Next Steps	280
Glossary	285

General Information

Purpose of this consultation

The Government is seeking views on the detailed proposals for the implementation of Electricity Market Reforms (EMR). The documents attached set out implementation proposals for the key mechanisms for reform: the Contracts for Difference and Capacity Mechanism, as well as the institutional and transitional arrangements. This consultation is relevant to electricity generators, electricity suppliers, electricity consumers and their representatives, network operators, Ofgem, environmental and energy efficiency organisations, electricity service companies, the construction sector, financial institutions and other stakeholders with an interest in the energy sector. DECC invites interested parties to submit comments and evidence.

Issued: 10/10/2013

Respond by: 24/12/2013

Responses and Enquiries to:

EMR Programme Team

Department of Energy & Climate Change,

4th Floor Area D,

3 Whitehall Place,

London, SW1A 2AW

Email: SecondaryLegislationEMR@decc.gsi.gov.uk.

Consultation online survey: https://econsultation.decc.gov.uk/decc-policy/emr-market-change/consult_admin_view

Consultation reference: URN 13D/218 – EMR: Consultation on Implementation

Territorial extent:

This consultation applies to England, Scotland, Wales and Northern Ireland.

How to respond:

Your response will be most useful if it is framed in direct response to the questions posed, though further comments and evidence are also welcome. Electronic responses should be enclosed to the email above.

Additional copies:

You may make copies of this document without seeking permission. An electronic version can be found at <https://www.gov.uk/government/consultations/proposals-for-implementation-of-electricity-market-reform>.

Hard copies are available online at www.tsoshop.co.uk; by telephone on 0870 600 5522; or by email on customerservice@tso.co.uk.

Other versions of the document in Braille, large print or audio-cassette are available on request. This includes a Welsh version. Please contact us under the above details to request alternative versions.

Confidentiality and data protection:

Information provided in response to this consultation, including personal information, may be subject to publication or disclosure in accordance with the access to information legislation (primarily the Freedom of Information Act 2000, the Data Protection Act 1998 and the Environmental Information Regulations 2004).

If you want information that you provide to be treated as confidential please say so clearly in writing when you send your response to the consultation. It would be helpful if you could explain to us why you regard the information you have provided as confidential. If we receive a request for disclosure of the information we will take full account of your explanation, but we cannot give an assurance that confidentiality can be maintained in all circumstances. An automatic confidentiality disclaimer generated by your IT system will not, of itself, be regarded by us as a confidentiality request.

We will summarise all responses and place this summary on our website at <https://www.gov.uk/government/organisations/department-of-energy-climate-change>. This summary will include a list of names or organisations that responded but not people's personal names, addresses or other contact details.

Quality assurance:

This consultation has been carried out in accordance with the Government's Code of Practice on consultation, which can be found here:

<http://www.bis.gov.uk/files/file47158.pdf>

If you have any complaints about the consultation process (as opposed to comments about the issues which are the subject of the consultation) please address them to:

DECC Consultation Co-ordinator
3 Whitehall Place
London SW1A 2AW
Email: consultation.coordinator@decc.gsi.gov.uk

Executive Summary

1. This consultation document seeks views on proposals for implementing the key mechanisms under Electricity Market Reform – the Contracts for Difference (CfDs), the Capacity Market, and associated institutional and delivery arrangements. A package of draft secondary legislation has been published alongside the consultation to help illustrate these proposals.
2. Responses are invited from all interested parties by 24 December 2013.

Electricity Market Reform

3. The Electricity Market Reform (EMR) programme is intended to incentivise investment in secure, low-carbon electricity generation, while improving affordability for consumers. The electricity sector is a critical part of the UK economy and is an important driver of growth.
4. EMR is the Government's response to the challenges facing the electricity sector:
 - A fifth of 2011 capacity has to close over the next ten years.
 - The need to transform our generation mix to respond to the challenge of climate change and meet our legally-binding carbon and renewable targets.
 - The expectation that electricity demand will continue to increase over the coming decades.
5. This amounts to a significant investment challenge, with an estimated investment of up to £110 billion needed in the sector over the next 10 years. This investment in turn has the potential to support up to 250,000 jobs in low carbon electricity to 2020.
6. The key elements of this market reform will be delivered through two new mechanisms to incentivise this investment. Contracts for Difference (CfDs) will provide long-term revenue stabilisation to low-carbon plant, allowing investment to come forward at a lower cost of capital and therefore at a lower cost to consumers. The Capacity Market will provide a regular retainer payment to reliable forms of capacity (both demand and supply side), in return for such capacity being available when electricity supply is squeezed. This will reduce the threat of blackouts due to insufficient capacity on the system.
7. The System Operator (National Grid) will be the delivery body for EMR, providing expert analysis to Government and administering both mechanisms. We are setting up a new private company, wholly owned by Government, to act as the counterparty to the CfD contracts – entering into such contracts when directed by Government or upon receipt of a notification from the delivery body of a person's eligibility for a CfD. We are also setting

up a Capacity Market Settlement Body, which will make capacity payments and retain accountability and control of the Capacity Market settlement process.

8. Minimising costs to consumers is a key aim for the EMR package. EMR will work with the market and encourages competition, minimising costs to consumers to deliver the investment we need. As a result of these reforms, household electricity bills are estimated to be, on average, around 9%– or £63 per annum – lower over the period 2016 to 2030 compared to decarbonising to a level of 100gCO₂/kWh through existing policy instruments¹. The impact on average bills for businesses and electricity intensive industries will be similar.
9. The draft EMR Delivery Plan, published in July, sets out a range of estimates for bill impacts considering a range of potential decarbonisation ambitions². Benefits for consumers increase over time due to increasing amounts of cheaper low-carbon electricity on the system, while the Capacity Market means prices are less volatile.

Context of this consultation

10. The Electricity Market Reform programme started with the publication of the first EMR consultation in December 2010³. Key developments have since been published by the following documents:
 - The EMR White Paper – published in July 2011⁴.
 - The EMR Technical Update – published in December 2011⁵.
 - The first EMR Policy Overview – published when Pre-Legislative Scrutiny⁶ on the draft Energy Bill commenced in May 2012⁷.
 - The second EMR Policy Overview – published alongside the introduction of the current Energy Bill⁸.
11. The Energy Bill⁹, which seeks powers to implement EMR, was introduced into Parliament in November 2012, now in its final stages with Royal Assent anticipated by the end of 2013, subject to the will of Parliament.

¹ This analysis assumes an illustrative carbon emissions intensity of 100gCO₂/kWh in 2030; for analysis based on emission intensities of 50gCO₂/kWh and 200gCO₂/kWh, please see the Impact Assessment published alongside the draft EMR Delivery Plan in July 2013).

² <https://www.gov.uk/government/speeches/statement-by-edward-davey-on-the-electricity-market-reform-draft-delivery-plan>

³ <https://www.gov.uk/government/consultations/electricity-market-reform>

⁴ <https://www.gov.uk/government/publications/planning-our-electric-future-a-white-paper-for-secure-affordable-and-low-carbon-energy>

⁵ <https://www.gov.uk/government/publications/planning-our-electric-future-technical-update>

⁶ The draft Energy Bill was scrutinised by the House of Commons Energy and Climate Change (ECC) Committee and a group of members of the House of Lords, and a report from each group was published in July 2012

⁷ <https://www.gov.uk/government/publications/electricity-market-reform-policy-overview>

⁸ <https://www.gov.uk/government/publications/electricity-market-reform-policy-overview--2>

⁹ <http://services.parliament.uk/bills/2010-11/energyhl.html>

12. Further details on EMR have been published in conjunction with those listed above, for example, the first CfD strike prices were published for consultation in July 2013 in the draft delivery plan consultation¹⁰. A full list of published detail, and future detail to come, can be found within [Table 1.1](#).
13. This consultation document does not cover the process of issuing, or the detailed terms, of investment contracts under Schedule 2 of the Energy Bill, or any contracts the Secretary of State may in the future direct the CFD counter party to enter into under (what is currently) clause 10.

Wider context

14. The key elements of EMR include:
- Contracts For Difference – detail covered in [Chapter 3](#).
 - Capacity Market - detail covered in [Chapter 4](#).
 - Institutional Arrangements – detail covered within Chapters 3, 4 and [5](#).
15. These mechanisms will be supported by:
- Carbon Price Floor – a tax underpinning the price of carbon emissions in the UK which was introduced in April 2013.
 - Emissions Performance Standard – a regulatory backstop to the amount of carbon dioxide emissions from new fossil-fuel power stations (see Annex B).
 - Action to promote Electricity Demand Reduction – addressed within Annex B, and also covered within Chapter 4 ([Section 4.2.2](#))
 - Ofgem’s measures to improve wholesale market liquidity – also addressed within Annex B.
 - Transitional arrangements sections:
 - Final Investment Decision Enabling for Renewables – detail published earlier this year¹¹.
 - Nuclear FID taken forward as a separate negotiation.
 - Supporting arrangements for the transition from the current Renewables Obligation support mechanism to CfD – detail consulted on separately¹².
 - Measures to improve the route to market for independent renewable generators – an update is published within Annex B.
 - Measures to help build the capability of the demand side in the electricity market (see [Section 4.3.2](#))

Implementation of EMR (summary within [Chapter 2](#))

¹⁰ <https://www.gov.uk/government/speeches/statement-by-edward-davey-on-the-electricity-market-reform-draft-delivery-plan>

¹¹ <https://www.gov.uk/government/publications/increasing-certainty-for-investors-in-renewable-electricity-final-investment-decision-enabling-for-renewables>

¹² [https://www.gov.uk/government/uploads/system/uploads/attachment_data/file/223489/ROtransitionconsultation17July2013.p](https://www.gov.uk/government/uploads/system/uploads/attachment_data/file/223489/ROtransitionconsultation17July2013.pdf)

16. The EMR mechanisms will be implemented through: the powers in the Energy Bill; secondary legislation, which will include the necessary detail which is too complex to be included in the Bill itself; changes to industry codes and licences; and supporting documents which sit outside the legislative framework such as the proposed CfD Allocation Technical Framework¹³. This consultation describes and seeks views on the detailed design proposals for implementing EMR, with draft illustrative secondary legislation. It sets out the EMR framework in detail in one place for the first time, providing more detail in key areas.¹⁴
17. A consultation on the associated code and licence changes is intended to be published early next year.

Implementing Contracts for Difference ([Chapter 3](#))

18. Contracts for Difference (CfDs) will support new investment in all forms of low-carbon generation (renewables, nuclear and CCS). CfDs have been designed to provide efficient and cost-effective revenue stabilisation for new plant, by removing exposure to the volatile wholesale electricity price. CfDs require plant to sell into the market as usual. The plant then receives a top-up from the market price to a pre-agreed 'strike price'. At times of high market prices, the plant is required to pay back the difference between the market price and the strike price thus protecting consumers from over-payment by ensuring that their supplier's liability under the scheme is minimised.
19. Government intends to move to a competitive price discovery process for all low-carbon technologies as soon as practicable.
20. The key documents for the implementation of CfDs are: CfD regulations along with code and licence changes¹⁵. The non-legislative implementing documents for the CfD regime, which are not covered by this consultation, include:
 - a. the CfD contract (published in draft for views in August 2013¹⁶)
 - b. the proposed CfD Allocation Technical Framework (The Government is proposing to bring forward amendments to the Energy Bill which enable it to set out the technical rules, details and procedures for the allocation process and is intended to be published in advance of the first CfD allocation, drawing upon the material set out in the Allocation Methodology published in August). We expect a draft to be published in early 2014 and a final version in late spring 2014.

¹³ See Chapter 3 for more detail on the proposed Allocation Technical Framework. The Government hopes to bring forward amendments to the Energy Bill which will enable the Secretary of State to implement some of the

¹⁴ The majority of policies set out here have already been discussed intensively with stakeholders and set out in previous EMR publications

¹⁵ Associated code and licence changes will be published for consultation in early 2014

¹⁶ <https://www.gov.uk/government/consultations/electricity-market-reform-contracts-for-difference-costs-exemption-eligibility>

21. This consultation describes the design of the CfDs, including the process for applying for and being allocated a CfD where National Grid is administering allocation and eligibility, the process leading up to commissioning of a CfD-supported plant, and the process for levying suppliers and paying CfD plant under the payment model. The consultation builds on previous policy publications, and seeks views on the detailed proposals which will be implemented largely through secondary legislation. It also provides further policy detail including in relation to the supply chain plan eligibility criteria; the CfD budget governance process; and full details of the mechanics and operation of the payment model for the CfD. Figure 1.1 summarises the CfD lifecycle.

Figure 1.1: Lifecycle of a Contract for Difference

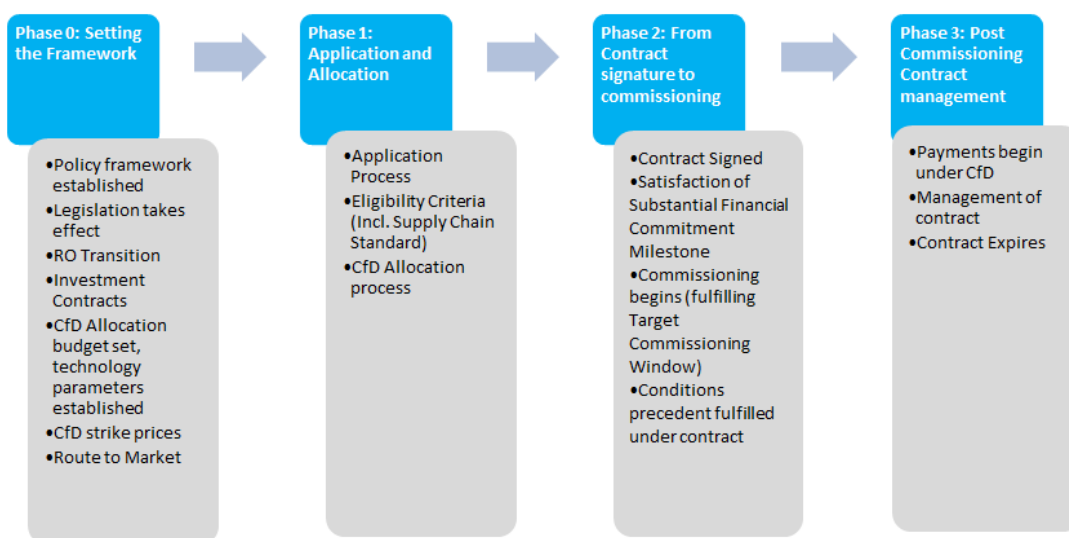

22. By managing the transition to CfDs we want to avoid an investment hiatus prior to the implementation of EMR. We are therefore putting in place measures to support the transition from the current Renewables Obligation to the CfD, through a period of dual running, which was subject to a separate consultation this summer¹⁷. We are also taking powers to allow early CfDs ('investment contracts') to be signed ahead of full EMR implementation, for those projects which need to take a final investment decisions before CfDs are available. Finally, we will consult separately towards the end of the year on policy proposals to ensure a route to market for independent CfD supported generators.

Implementing the Capacity Market ([Chapter 4](#))

¹⁷https://www.gov.uk/government/uploads/system/uploads/attachment_data/file/223489/ROtransitionconsultation17July2013.pdf

23. The Capacity Market will provide incentives for investment in the overall level of reliable capacity (supply and demand side) needed to ensure secure electricity supplies. Capacity providers will continue to sell into the electricity market, but alongside the electricity price capacity providers will receive a regular payment in return for which such capacity must be provided when the system is tight, or the provider will face a penalty.
24. The key documents for the implementation of the Capacity Market are:
- Electricity Capacity Regulations
 - Electricity Capacity (Payment) Regulations
 - Capacity Market Rules (including a draft capacity agreement)
 - Consequential amendment to existing licences and codes
25. As well as setting out the overall framework, this consultation covers Capacity Market policy, including setting the amount to auction, pre-qualifying for the auction, how the auction will work, secondary trading outside the auction, the penalties on capacity providers for non-delivery, rules for participation of demand-side response (DSR), the payment model, institutional arrangements, and terms of capacity agreements. The consultation builds on previous policy publications, providing further detail, and seeks views on the proposals which will be implemented through the draft Secondary legislation. Figure 1.2 summarises the stages of Capacity Market operation.

Figure 1.2: Stages of Capacity Market Operation

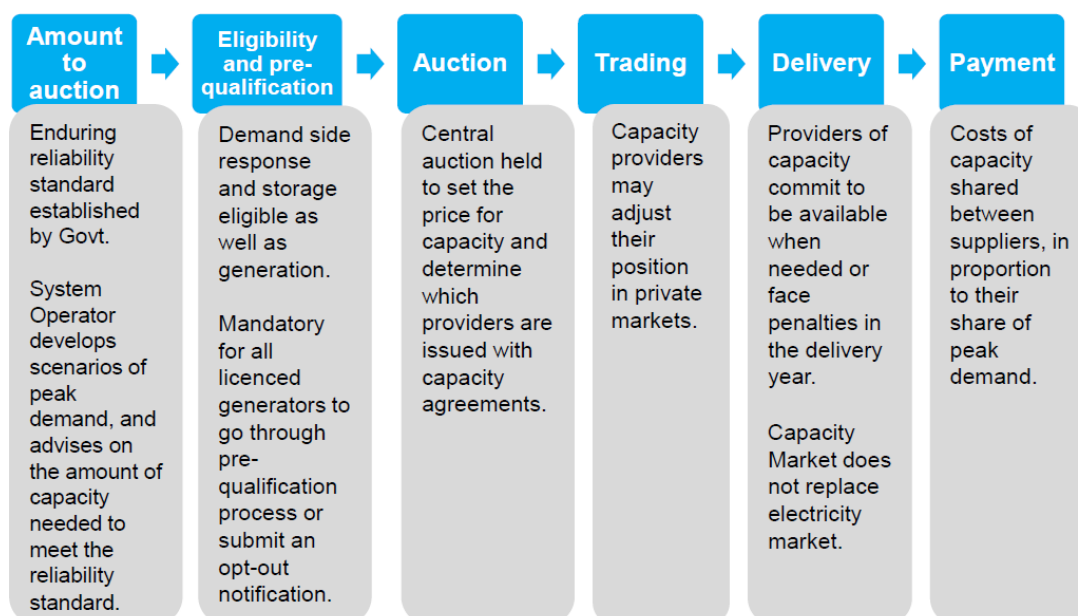

26. The demand side also has an important role to play in meeting the Government's objectives for the electricity sector. The EMR framework includes provision for demand-side response (shifting demand from one time to another) to compete into the Capacity Market on equal terms, and in the early years we will run DSR-only auctions on an annual

basis in order to help develop the DSR market. In addition, we will run a pilot in 2014-2015, with funding of at least £20 million, to assess the scope for permanent electricity demand reduction measures to help meet the objectives of EMR. Following the outcome of this pilot we will assess whether demand reduction could compete in future Capacity Market auctions alongside DSR and generation.

Ensuring effective and transparent delivery of EMR ([Chapter 5](#))

27. National Grid will be the delivery body for EMR. This consultation sets out more information on how potential conflicts of interest for National Grid will be managed, and seeks views on whether National Grid should be protected from being liable in damages to third parties for any loss or damage caused to those third parties whilst performing its EMR delivery body functions.
28. The Institutional Arrangements for EMR are covered in the chapters on each mechanism which explain the roles, as appropriate, of National Grid, the counterparty, the settlement body for the Capacity Market and the role of the regulator (Ofgem).
29. The EMR delivery plan will be published every five years, and will set out information on the EMR mechanisms. This will include in the administrative price-setting period the CfD strike prices for renewable technologies, and in the future the timing and details of auctions; and the volume to procure under the capacity market. The delivery plan will be supplemented by Annual Updates. The first draft delivery plan, covering the period 2014-2018, was published for consultation in July 2013¹⁸.
30. This consultation seeks views on the enduring delivery plan process and on how to ensure sufficient transparency and reporting for the EMR programme. More widely, the Government has introduced a duty under the Energy Bill to report annually on how it has delivered the EMR objectives as set out in the Bill¹⁹.

EMR in the Devolved Administrations ([Chapter 6](#))

31. The UK Government has been working closely with the Scottish and Welsh Governments and Northern Ireland Executive in developing the EMR proposals. We are drawing up a Memorandum of Understanding with the Devolved Administrations setting out how we will work together following Royal Assent of the Energy Bill.

Next steps ([Chapter 7](#))

32. This consultation will close on 24 December 2013. We will publish more detail during the consultation on a number of areas including the supply chain plan. These elements will be published in November and will be subject to the same closing date as the rest of the consultation.

¹⁸ <https://www.gov.uk/government/speeches/statement-by-edward-davey-on-the-electricity-market-reform-draft-delivery-plan>

¹⁹ See what is currently clause 5(4) of the Energy Bill.

33. Subject to the will of Parliament, we anticipate that the Energy Bill will receive Royal Assent by the end of 2013. We plan to publish the final EMR delivery plan on a similar timeframe, alongside issuing updated terms for the CfD contract.
34. Following the close of the consultation, we will consider responses and draft the implementing secondary legislation. We intend to publish the Government response and lay the final package of secondary legislation in Parliament in late spring 2014 and for the regulations to come into force in summer 2014. Implementation of EMR is subject to State Aid approval, and we are working with the European Commission to secure this.
35. Government is currently working with industry and delivery partners to ensure that industry systems and processes are ready for EMR launch. This collaboration consists of a series of open and transparent working groups with representation from all parties involved in ensuring system readiness, including DECC and its delivery partners, generators, suppliers and demand-side representatives²⁰.
36. The first early CfDs could be signed in the form of investment contracts early next year, and the first CfDs under the enduring regime in the second half of 2014. We plan to run the first capacity auction in November 2014, for delivery during winter 2018/19, subject to State Aid approval.
37. Throughout this document references are made to the Energy Bill that is currently going through Parliament. These references relate to the version of the Bill as amended by Lords Committee available on the Parliament website²¹. The Government is also planning to amend this Bill as referred to in the relevant parts of this document. This consultation document assumes the Bill and the proposed Government amendments will be made by Parliament; the Government amendments are, however, subject to Parliamentary approval.

²⁰ <https://www.gov.uk/government/policy-advisory-groups/electricity-market-reform-emr-collaborative-development>.

²¹ <http://services.parliament.uk/bills/2010-11/energyhl.html>

Chapter 1: Aims of the Consultation

Consultation Scope

38. This document seeks views on the Government's proposals for implementing the following components of EMR within Great Britain:
- a) The detailed policy framework for Contracts for Difference (CfD).
 - b) The detailed policy framework for the Capacity Market.
 - c) The institutional delivery arrangements for the above mechanisms.
39. A package of draft secondary legislation has been published alongside this consultation. We are publishing these draft statutory instruments to illustrate how the policy proposals discussed in this consultation might be reflected in implementing secondary legislation. We hope the draft legislation will assist readers understand the regulatory changes which are required for the implementation of these proposals and their practical implications.
40. The draft secondary legislation accompanying this consultation will be revised following the outcome of the consultation to reflect final policy decisions. We plan to lay these in Parliament in late spring 2014 with the aim of having them in force by the end of July 2014. [Table 1.2](#) indicates those parts of EMR for which we have published illustrative draft secondary legislation. The draft regulations may in a few instances not reflect up-to-date policy proposals. Where there is a discrepancy, it is the consultation document which reflects the current policy proposal. We would be grateful if you would indicate to us where you do find any discrepancies.

What the consultation does not cover

41. This document aims to provide a comprehensive package of all of the reforms which are being proposed to implement EMR. The document describes the proposals, how they are intended to work and the effect they will have in practice.
42. Some of the proposals referred to in this document are outside the scope of this consultation, either because they have been developed through prior consultation and discussion with stakeholders, or because they will be published at a later date. For example, the reliability standard for the Capacity Market and the CfD strike prices have been the subject of consultation in the EMR delivery plan consultation²² which closed in September 2013. Similarly, the terms of the generic CfD have been the subject of extensive discussion with stakeholders, including relevant industry players²³.

²² <https://www.gov.uk/government/consultations/consultation-on-the-draft-electricity-market-reform-delivery>

²³ Draft heads of terms published in Nov 2012:

https://www.gov.uk/government/uploads/system/uploads/attachment_data/file/65636/7078-electricity-market-refrom-annex-b.pdf

Key CfD terms to form the basis of the CfD Contract, published in May 2013:

<https://www.gov.uk/government/publications/electricity-market-reform-delivering-uk-investment>

43. This consultation document does not cover the process of issuing or detailed terms of investment contracts under Schedule 2 of the Energy Bill, or any contracts the Secretary of State may in future direct the CFD Counterparty to enter into under Clause 10.
44. Table 1.1 provides a summary of the proposals captured by this consultation; those which are outside the scope of this consultation and those which we plan to publish following this document (and are therefore also outside the scope of this consultation).

Table 1.1: Summary of consultation scope

Proposals within the scope of this consultation	<ol style="list-style-type: none"> 1. Contracts for Difference: <ul style="list-style-type: none"> • CfD Allocation (including institutional arrangements) – the process by which CfDs will be allocated • CfD Supplier obligation proposals – the process for making payments against the CfD contracts • Investment Contracts – the transfer of early CfD contracts from the Secretary of State to the CFD counterparty • The transitional period between the Renewables Obligation and the CfD (2014-17) 2. Capacity Market: <ul style="list-style-type: none"> • Electricity Capacity Regulations • Electricity Capacity (Payment) Regulations • Capacity Market Rules (including a draft capacity agreement) • Consequential amendment to existing licences and codes 3. Proposals relating to the EMR System Operator and the EMR delivery plan: <ul style="list-style-type: none"> • Analysis required from the System Operator and what information will be required from CfD generators • Timing and content of EMR delivery plans • Governance of the System Operator
Detail previously published for views	<ol style="list-style-type: none"> 1. Draft CfD contract 2. Draft CfD strike prices for renewables (published as part of the draft EMR delivery plan²⁴) 3. CfD Supplier Obligation Call for Evidence (published alongside the EMR Overview Document in November 2012), and subsequent Government response in August 2013²⁵ 4. CfD cost exemption eligibility for Electricity Intensive Industries²⁶ 5. Capacity Market: The draft Reliability Standard (published as part of the draft EMR delivery plan)²⁷ 6. Consultation on National Grid (system operator) conflicts of interest²⁸ 7. Transition from Renewables Obligation to Contracts for Difference²⁹ 8. Electricity Demand Reduction: Options for reducing demand³⁰
Detail to be subsequently published	<ol style="list-style-type: none"> 1. Further CfD contract (alongside the EMR delivery plan) 2. CfD strike prices for Renewables (within the EMR delivery plan expected in December 2013) 3. CfD Supplier Obligation – Exemption for Electricity intensive industries 4. Supply Chain assessment process and detailed criteria – November 2013 5. CfD Allocation Technical Framework – draft to be published in early in 2014 6. Capacity Market: Updated Reliability Standard (to be published within the EMR delivery plan)

²⁴https://www.gov.uk/government/uploads/system/uploads/attachment_data/file/238867/Consultation_on_the_draft_Delivery_PI_an_amended_pdf

²⁵<https://www.gov.uk/government/consultations/contracts-for-difference-cfd-supplier-obligation-call-for-evidence>

²⁶<https://www.gov.uk/government/consultations/electricity-market-reform-contracts-for-difference-costs-exemption-eligibility>

²⁷<https://www.gov.uk/government/speeches/statement-by-edward-davey-on-the-electricity-market-reform-draft-delivery-plan>

²⁸<https://www.gov.uk/government/consultations/synergies-and-conflicts-of-interest-arising-from-the-system-operator-delivering-electricity-market-reform-emr>

²⁹https://www.gov.uk/government/uploads/system/uploads/attachment_data/file/223489/ROtransitionconsultation17July2013.pdf

³⁰<https://www.gov.uk/government/consultations/options-to-encourage-permanent-reductions-in-electricity-use-electricity-demand-reduction>

- | | |
|--|--|
| | <p>7. Route to Market: Consultation on policy proposals expected in early 2014</p> <p>8. Emissions Performance Standard regulations – to be published during 2014, following Royal Assent of the Energy Bill</p> |
|--|--|

What we will do with responses and next steps

45. This consultation closes for responses on 24 December. We will then analyse responses and make any appropriate changes to our proposals. Our final policy decisions will be announced in a Government response to the consultation, which we plan to publish in spring 2014. The secondary legislation to implement EMR will need to be laid in and approved by Parliament before the EMR mechanisms can come into effect. Our intention is to lay the draft implementing Secondary legislation in late spring 2014 with the aim to have these in force in July 2014.
46. The implementing secondary legislation can only be laid once the enabling powers in the Energy Bill come into force (shortly after the Bill receives Royal Assent). We expect to receive Royal Assent by the end of 2013, subject to the will of Parliament.
47. According to this timeframe we expect the first applications for CfDs under the generic EMR regime to be made in the second half of 2014, and the first Capacity Market auction by the end of 2014, for delivery during 2018/19.

How to respond to this consultation

48. The Government welcomes responses to the questions posed within this consultation. Questions refer to specific implementation proposals as well as testing whether the proposed policy framework will deliver the stated policy objectives. These questions are captured within orange boxes throughout the document.
49. If you disagree with any of the implementation proposals within this document and have alternative suggestions, it would be helpful if you can provide supporting analysis to explain your position.
50. We welcome electronic responses, either through a proforma sent to the email address supplied³¹ or through the online survey³², or hard copy responses – using the proforma provided sent to the address supplied³³³⁴.
51. The Government will continue to engage with stakeholders throughout the consultation period. Workshops will be held in London, on both the Contracts for Difference and the

³¹ SecondaryLegislationEMR@decc.gsi.gov.uk.

³² A Performa can be found within Annex D to this publication. Or you can access the online survey which will enable you to view and respond to all of the consultation questions published within this document. This can be accessed at: https://econsultation.decc.gov.uk/decc-policy/emr-market-change/consult_admin_view

³³ EMR Programme Team, Department of Energy & Climate Change, 4th Floor Area D, 3 Whitehall Place, London, SW1A 2AW

³⁴ See the [General Information](#) section

Capacity Market, and also in each of the Devolved Administrations. These will take place throughout the consultation period and are aimed at identifying key stakeholder issues as early as possible. The Government will continue to communicate with stakeholders through the existing EMR Expert Groups, Industry and other industry fora and other meetings set up by EMR policy teams. We have also initiated collaborative development workshops to engage further with industry on how EMR should work in practice. More on this detail can be found within [Chapter 7](#).

52. This consultation focuses on the key policy proposals for EMR implementation which will be set out in the implementing secondary legislation. As noted in Table 1.1, there are further areas of EMR where more detailed policy development will be necessary. We will continue to engage with stakeholders alongside this consultation process to develop these additional proposals in order to put together a complete EMR package for implementation next year.

Chapter 2: Implementing EMR

EMR design overview

53. Figure 1.3 indicates how the key EMR mechanisms will fit together to provide a secure, competitive and low-carbon electricity market. The sections below detail how the mechanisms will be implemented, through legislative and non-legislative measures and operationally, by market participants.

Figure 1.3: Overview of Electricity Market Reform³⁵

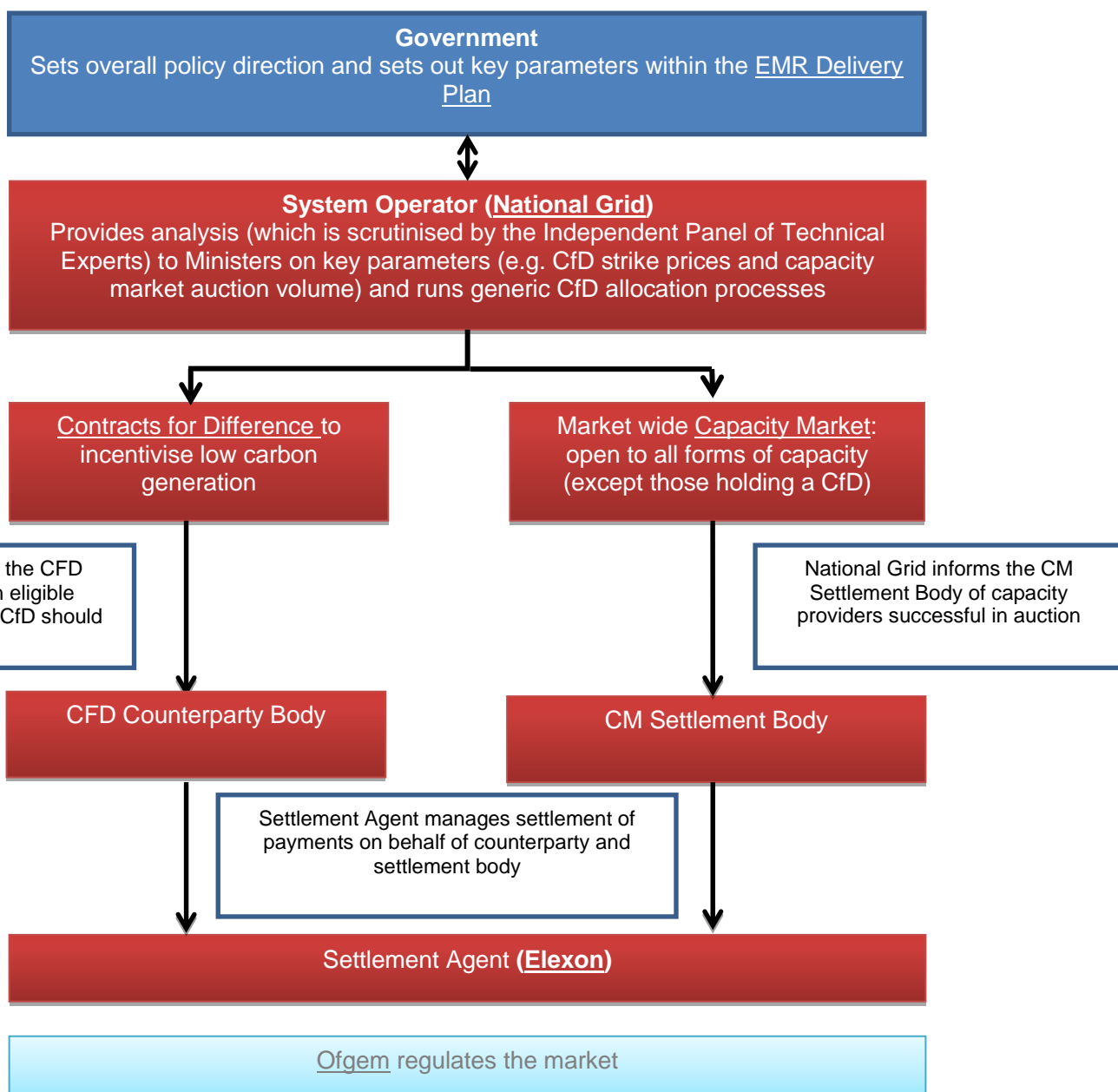

³⁵ To access previously published information electronically – hold Ctrl and left click on the underlined item

How EMR will be implemented

54. The Energy Bill was introduced to Parliament in November 2012³⁶. The Bill sets out the objectives of EMR (for example to ensure a secure, low-carbon and affordable electricity supply) and seeks to provide the Secretary of State with powers to enact the necessary changes to the market to achieve these objectives - supporting investment through the Contracts for Difference and the Capacity Market - and the associated measures to support these mechanisms.
55. This consultation document explains how the powers provided to the Secretary of State in the Energy Bill will be exercised to deliver EMR's objectives. Different types of secondary legislation will need to be made to implement the EMR proposals. The CfD will primarily be implemented by regulations supporting the CfD contract. The Capacity Market will be implemented by a mixture of regulations and rules. Both the CfD and the Capacity Market will also require changes to industry licences and codes. Where possible we have provided illustrative drafts of the implementing secondary legislation ([see Table 1.2](#)). The illustrative drafts are designed to assist the reader to understand the proposals contained in this consultation document and should be read consistently with the proposals³⁷.
56. Under provisions in Chapter 2 of the Bill, the Secretary of State is required to consult the Devolved Administrations (DAs) before making CfD regulations. Close working and strong collaboration between DECC and the DAs on the design and delivery of CfDs is therefore important to the successful delivery of the CfD scheme. Further detail about EMR in the Devolved Administrations can be found in [Chapter 6](#).
57. Figure 1.4 shows an indicative timeline for the key EMR milestones, including the Energy Bill and the subsequent legislative action by the Government. This indicates the planned timetable for the signing of FID enabling for renewables investment contracts; signing of first enduring CfDs; and the running of the first Capacity auction. The implementation of EMR is subject to Royal Assent of the Energy Bill and State Aid approval from the European Commission and we are working with the Commission to secure this as soon as possible. More detailed implementation plans for both the CfDs and the Capacity Market can be found within [Chapter 7](#).

³⁶ <https://www.gov.uk/government/publications/electricity-market-reform-policy-overview--2>

³⁷ This legislation will be supported by other key documents necessary for the implementation of EMR, for example the generic CfD contract template, the Capacity Market Rules, and the CfD Allocation Technical Framework.

Figure 1.4: Indicative EMR Roadmap

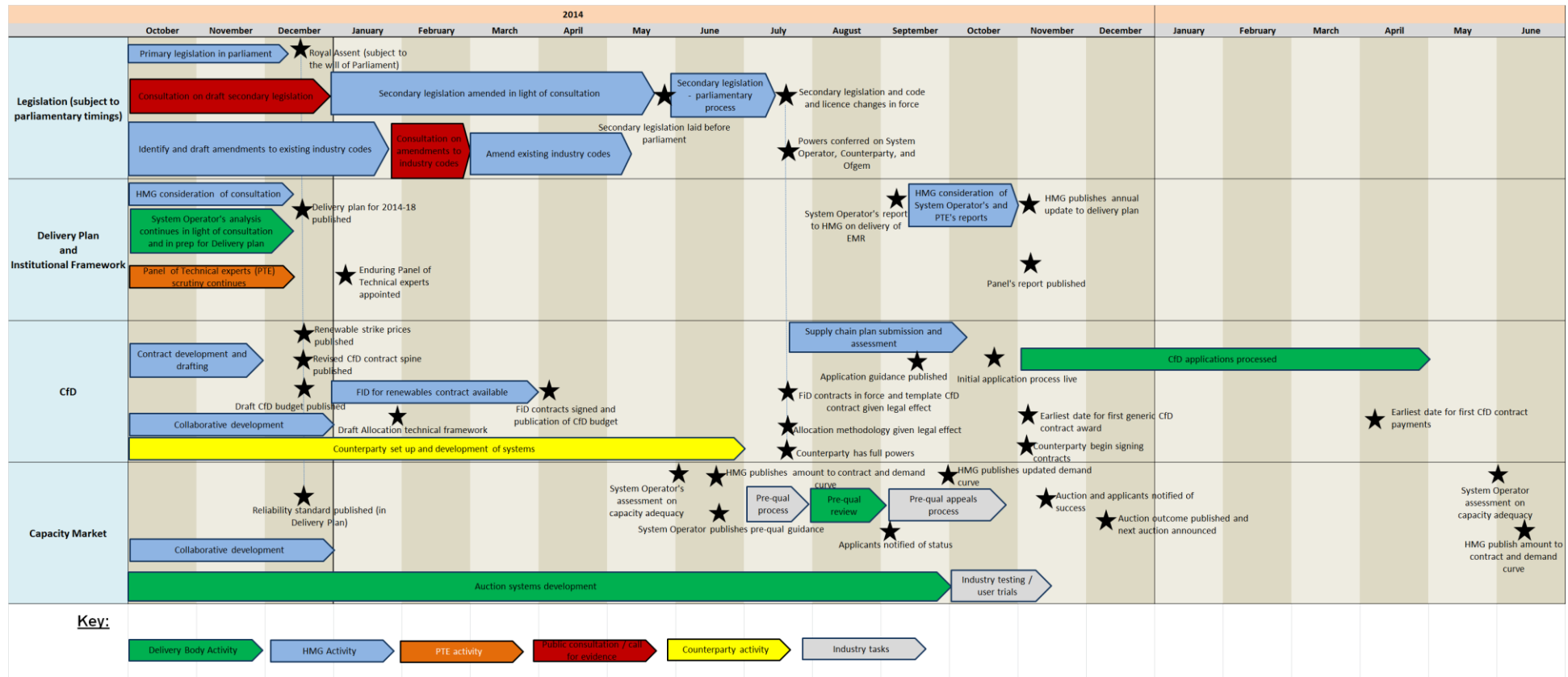

Legislative Framework for EMR

Figure 1.5: Overview of the legal structure for market reforms

Key

Green – within the scope of this consultation

Blue – outside the scope of this consultation

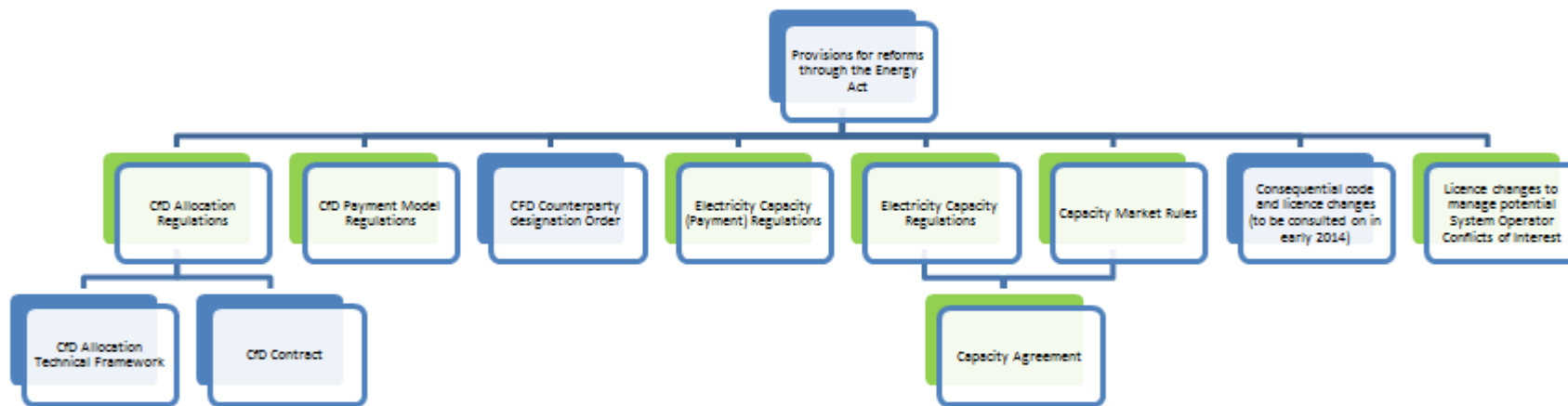

58. Figure 1.5 provides an overview of the key components of EMR legislation. The following section summarises the legal framework for the implementation of the key EMR mechanisms, followed by chapters setting out the detailed implementation proposals.

Contracts for Difference (see [Chapter 3](#))

59. Contracts for Difference will provide investors with long-term support for low-carbon generation – reducing the risks currently faced by generators of exposure to volatile wholesale electricity prices and increasing price certainty through long term contracts. Box 1 sets out the legal framework of CfDs.

Box 1: Legal Framework of Contracts for Difference

Energy Bill provisions

The Energy Bill enables the Secretary of State to implement the Contracts for Difference regime through a combination of regulations and a private law contract between generators and the counterparty. The CfD will define the level of support a generator will receive, which will be dependent on the technology of the plant.

We plan to make a further amendment to the Energy Bill to enable the Secretary of State to determine and publish the standard terms for Contracts for Difference in accordance with the criteria set out in the Bill and subsequently in implementing regulations.

Generators will be able to request minor and necessary modifications to these terms from the counterparty body before making an application to the delivery body for a CfD. If an applicant (A) meets the eligibility criteria, National Grid will notify the counterparty body that A is eligible for a CfD.

The Secretary of State will also publish details of the budget and rules that the delivery body must follow in allocating support for generation technologies, in the proposed Allocation Technical Framework³⁸.

CfD Secondary legislation

- The Secondary legislation comprises regulations and code and licence changes. The regulations will set out the kind of provision to be included in

³⁸ See further Chapter 3. The proposed Allocation Technical Framework is a document which is intended to be published alongside implementing CfD allocation regulations. The Government intends to bring forward an amendment to the Energy Bill to enable the Secretary of State to produce such a document to help implement the allocation process.

- the standard CfD terms. the circumstances in which and how the counterparty can agree adjustments to these terms before offering a contract;
- the criteria that National Grid must assess potential projects against, and the counterparty will be required to offer contracts to eligible generators in accordance with the scheme;
 - the types of allocation for those successful in application: and
 - the detail which National Grid must supply to the Secretary of State in order for the Secretary of State to set CfD strike prices.

The costs of the CfDs will be met by electricity suppliers who will be required to make payments to the counterparty – the requirement being referred to as the “Supplier Obligation”. The CfD regulations will also set out the detail of the Supplier Obligation under which they will make payments. The detail of the code and licence changes will be subject to separate consultation during early 2014.

CfD Contract Terms

CfDs will be private law contracts between the counterparty and eligible generators. The Government published the CfD heads of terms in November 2012³⁹ and draft key contract terms in August 2013⁴⁰, providing detail of the contract terms which will form a basis of the final CfD contract. Views were sought on the draft terms, which were developed through engagement with industry, consumer representatives and other stakeholders.

CfD Allocation Technical Framework⁴¹

This document will set out details of the allocation process, i.e. how an eligible generator will be allocated a CfD. This document will also contain information about the budget available for each allocation round. Whilst it is hoped that the CfD budget will not need to be frequently amended it is sensible to ensure that the budget assigned to the allocation of CfDs can be quickly amended when this is needed to, for example, maintain the integrity of the allocation process or ensure that value for money is being delivered to consumers. Putting the budgetary detail in this document, and therefore outside of secondary legislation, will help to ensure that changes to the budget and other allocation rules can be made quickly where such a change is warranted. Subject to the necessary amendments being made to the Energy Bill - the Government intends to publish the draft Allocation Technical Framework (ATF) early in 2014, and the final ATF in late spring 2014. A table on

³⁹ https://www.gov.uk/government/uploads/system/uploads/attachment_data/file/65636/7078-electricity-market-reform-annex-b.pdf

⁴⁰ <https://www.gov.uk/government/publications/electricity-market-reform-delivering-uk-investment>

⁴¹ See footnote 37.

page 37 sets out how the detail of the CfD allocation methodology will be split between the regulations, and the ATF.

Consequential amendments to existing licences and codes

As a consequence of the Energy Bill's provisions to implement CfDs, existing electricity licences, industry documents and related agreements may require consequential amendments. These modifications, if required, will be in addition to the regulations and rules.

The proposed draft amendments will be published in early 2014 and views from interested parties will be sought.

60. Detailed implementation proposals for the CfD contracts are set out in [Chapter 3](#).

The Capacity Market (see [Chapter 4](#))

61. The Capacity Market is designed to cost effectively ensure that sufficient capacity is available to ensure security of electricity supply. It will do this by providing certain, regular payments to capacity providers, in return for which those providers must be available and produce electricity (or reduce demand) when the system is tight, or face penalties. The Capacity Market will be implemented and administered by a combination of the Government, Ofgem, the National Grid and a settlement body.
62. Box 1.2 sets out the legal framework of the Capacity Market.

Box 1.2: Legal Framework of the Capacity Market

Energy Bill provisions

The Energy Bill seeks provision to establish the Capacity Market by including powers for capacity agreements, capacity auctions and payments to flow via a settlement body. The Bill allows for a combination of regulations and Capacity Market rules to be used to bring the Capacity Market into effect.

Electricity Capacity Regulations

The draft Electricity Capacity Regulations and Electricity Capacity (Payment) Regulations include aspects covering:

- the reliability standard that the Secretary of State will set;
- the process for determining whether a capacity auction will be held as well as the amount of capacity to auction;
- the eligibility criteria and settlement of payments; and
- provisions for the Authority to make and amend the Capacity Market rules which come into force at the same time as the Regulations and Payment Regulations.

The Secretary of State will retain responsibility for the regulations.

Capacity Market Rules

The draft Capacity Market Rules will provide the detail for implementing much of the operating framework set out in the regulations. This means the rules provide much of the technical rules and procedures as to how the Capacity Market will operate and include aspects covering:

- the auction guidelines and de-rating information;
- pre-qualification information;
- how eligibility is determined;
- the process of holding capacity auctions and issuing of capacity agreements;
- setting up and operating the capacity market register;
- system stress events;
- secondary trading;
- DSR transitional arrangements; and
- disputes and appeals.

The Capacity Market Rules will be made by the Secretary of State and once they come into force, it is proposed that Ofgem should subsequently be responsible for making any changes to them.

Capacity agreement

The regulations and rules make provision for capacity agreements which will be issued to those bidders successful in a capacity auction. A successful bidder will accrue rights and obligations in accordance with the regulations and rules. These include the obligation to provide capacity, the right to receive capacity payments and the liability to pay penalties.

The capacity agreement will be issued to successful bidders and will also be entered onto the capacity market register. Neither the register nor the capacity agreement

create a contractual relationship with the successful bidder, but instead are underpinned by the regulations and rules.

Consequential amendments to existing licences and codes

As a consequence of the Energy Bill's provisions to establish the Capacity Market, existing electricity licences, industry documents and related agreements may require consequential amendments. These modifications, if required, will be in addition to the regulations and rules.

The proposed draft amendments will be published in early 2014 for consultation of views from interested parties will be sought.

63. Detailed implementation proposals for the Capacity Market are provided in [Chapter 4](#).

Supporting measures

64. The CfD and Capacity Market implementation will be complemented by:
- Transitional arrangements for the early years of EMR (2014-17) – including regulations on the transition from the Renewables Obligation to the CfD and on Investment Contracts (covered in [Chapter 3](#)).
 - Governance documents to implement the institutional arrangements for delivery of both the Contracts for Difference and the Capacity Market (covered in detail within [Chapter 3](#) and [Chapter 4](#) of this document).
 - Publication of the EMR delivery plan on a 5-yearly basis, starting with the first delivery plan 2014-18 in December 2013. This was the subject of a separate consultation (launched in July 2013)⁴². However some legislative provision may be required to implement certain aspects of what is said in the draft Delivery Plan, see [Chapter 5](#).
 - Licence and code modifications to mitigate any potential conflicts of interest for the System Operator in performing its role for EMR (are covered in [Chapter 5](#) of this document).
65. Further transitional and supporting mechanisms and the expected timescales are outlined within [Annex D](#). These include actions:

⁴² <https://www.gov.uk/government/consultations/consultation-on-the-draft-electricity-market-reform-delivery>

- To increase Electricity Demand Reduction – the Government published its response to consultation findings in May 2013⁴³, and we have committed to testing proposals via a pilot. Further detail will be published within the Energy Efficiency Strategy planned to be published by November 2013.
- To improve the route to market for independent renewable generators – the Government expects to consult on policy proposals later in 2013.
- By Ofgem to increase wholesale market liquidity – Ofgem is expected to take a final decision on its reforms in Autumn 2013 with a view to full implementation taking place in the early part of 2014.
- To monitor and enforce the emissions of new plant through the Emissions Performance Standard⁴⁴.

The roles of market participants

Figure 1.6: Overview of principal institutions and their roles in implementing EMR

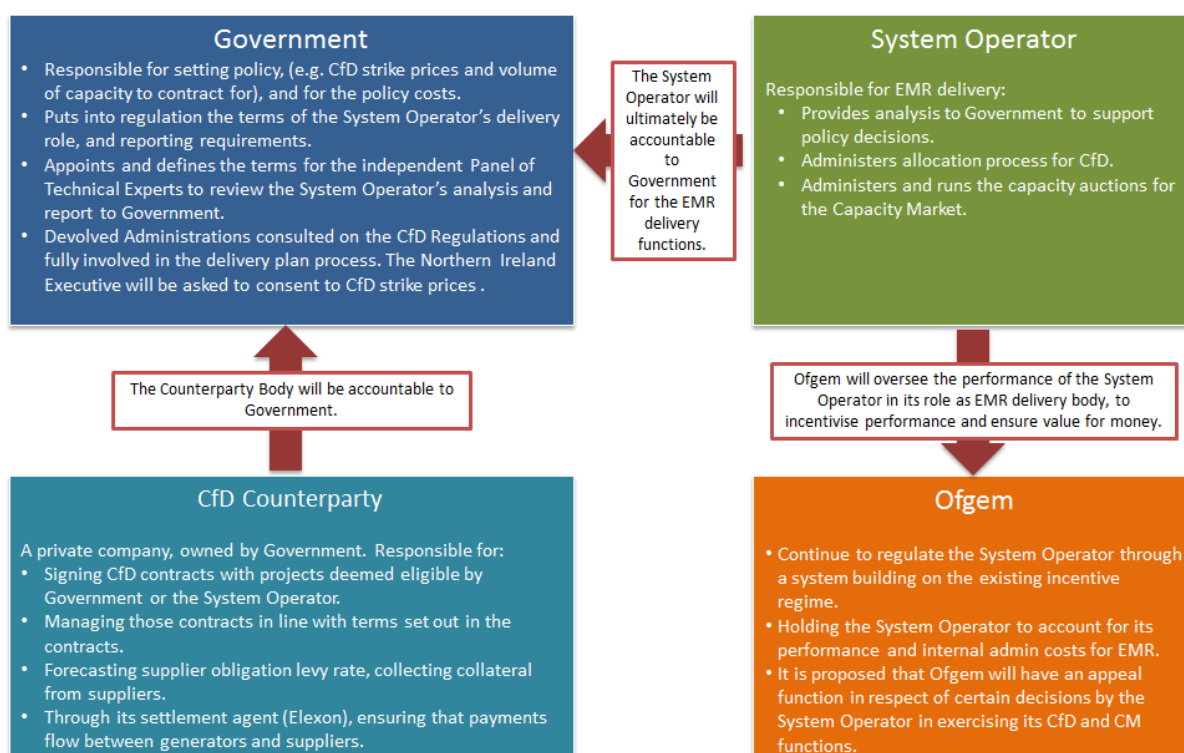

⁴³ <https://www.gov.uk/government/consultations/options-to-encourage-permanent-reductions-in-electricity-use-electricity-demand-reduction>

⁴⁴ Government intends to consult on detailed arrangements for the EPS monitoring and enforcement regime applying in England once the Energy Bill has received Royal Assent. Therefore DECC intend to consult on proposals for these arrangements in 2014.

66. A number of parties will need to be involved in preparing for EMR implementation:
- **Government** – Sets the policy framework, provides sponsorship, leads design and legislative action.
 - **Ofgem** – Regulates the electricity market, provides design advice, analysis and regulation.
 - **National Grid** – EMR delivery body, administrator of CfD allocation and Capacity Market auction and provide advice to the Government.
 - **CfD Counterparty** – Acts as counterparty and administers CfDs, manages the supplier obligation.
 - **Capacity Market Settlement Body** – Makes capacity payments and retains overall accountability and control of the Capacity Market settlement process.
 - **Settlement Agent** – Carries out the settlement of CfDs on behalf of the counterparty and Capacity Market agreements on behalf of the Settlement Body.
 - **Devolved Administrations** – Oversees implementation and monitoring of proposals with DECC. Further information can be found within [Chapter 6](#).
 - **Generators** – Participants and parties to CfD and Capacity Market agreements.
 - **Suppliers** – Contributors to CfD and Capacity Market funding arrangements.
67. Separately DECC is working with stakeholders to develop the operational systems and processes needed to implement EMR. This ‘collaborative development’ will aid the development of the operational model for EMR and as such is not subject to this consultation on the detailed policy proposals. More information on this process and its outputs is provided by way of background in [Chapter 7](#).

Developer journeys under the CfD and Capacity Market

68. [Chapter 3](#) sets out the detailed proposals under which a generator may apply for a CfD and the processes by which the delivery body determines whether a project is eligible for a CfD.
69. Box 3 provides a detailed account of the process a generator must go through in order to secure and receive payments under a CfD.

Box 3: A low carbon generator's journey

This box sets out a simplified overview of our current proposal for how a generator would secure a CfD for the purpose of illustrating the end to end process. For this illustration we have taken the example of an Onshore Wind Generator of 300 MW situated in England and planning to connect directly to the National Grid.

Pre-application

First the generator should review whether it is eligible to apply for a CfD, against the published eligibility criteria. If it is eligible it will, if it is a project of 300MW or more, have to prepare a supply chain plan for approval from the Secretary of State before making their application. If the supply chain plan is approved by the Secretary of State the generator will need to go on to show how it fulfils the eligibility criteria, see section below on “application and allocation”

As part of making its application, the generator will need to also consider if it required any minor or necessary modifications to the generic CfD contract terms. This might be the case if the generator feels it is unable to sign the generic CfD contract terms, and could not be reasonably expected to make changes itself. If such modifications are felt to be necessary, the generator will need to approach the Counterparty Body to discuss the changes it needs prior to making an application to the delivery body.

Application and Allocation

An eligible generator would then gather together evidence against the eligibility criteria, and submit this together with the application form to National Grid. In this instance this would include obtaining evidence of planning permission, approval of the project's supply chain plan from the Secretary of State for Energy and Climate Change, evidence of the Grid connection offer, evidence that the generator is a validly incorporated company in England and other supporting information that will enable the contract to be executed.

National Grid will then assess the application, and assess the budget available. If there is at least 50% of the available budget left in the delivery year, or any subsequent delivery year, and the applicant satisfies the eligibility criteria, National Grid will make a notification to the counterparty that the generator can be party to a CFD and notify the generator at the same time.

In the event that a significant proportion of any delivery year budget is not available at the time of application (e.g. less than 50% of the budget is available), the delivery body will seek Government's approval to begin the Allocation Round process. If

approval is given then the generator's application will be taken forward into an allocation round. Should demand (determined by reference to all of the applications received at that point in time) exceed the available budget then the delivery body will, again, seek Government approval to apply the budget constraint process and, if approval is given, the bids in the round will be assessed through an auction. Following the outcome of the auction, National Grid will notify the generator on whether they have been successful in securing a CfD.

If the application is not deemed to be eligible, or the paperwork is not in order, National Grid will inform the generator. The generator will have the opportunity to re-submit their application if it was incomplete. The generator will also have an opportunity at this point to appeal National Grid's decision if believed that the delivery body had not complied with the legislation resulting in an incorrect decision on allocation of a CfD.

In the first instance the appeal would go to National Grid, who will review their initial decision (for example for any errors in information processing). If National Grid rejects the appeal, the applicant can choose to appeal to Ofgem.

Once the CFD Counterparty Body receives a notification from National Grid about a person to whom a CfD might be offered it will send the generator a contract. The Counterparty Body will also insert the relevant Target Commissioning Date (TCD) and start of Target Commissioning Window (TCW); and further details that are technology specific, for example the reference price for intermittent generation and the appropriate strike price set for Onshore wind.

The generator will review and sign the contract. Once the Contract has been signed, the generator will begin the work of building and commissioning the wind farm. The Counterparty Body will monitor progress and enforce the terms of the contract.

Post Commissioning and Contract Management

Once the wind farm meets the conditions precedent in the contract, the Generator is entitled to begin receiving payments through the contract. These payments will be raised through a levy on suppliers and will flow first through the Counterparty Body (who will hold reserve and risk funds to protect against the risk of default and ensure liquidity of the scheme), and then from the Settlement Agent, ELEXON, to the Generator.

The generator will continue receiving payments in this way until the contract expires and as long as the strike price is higher than the current reference (market) price for electricity. When the reference price is higher than the strike price, the generator will pay the difference to the counterparty, which will pass this on to suppliers.

70. [Chapter 4](#) sets out the detailed proposals under which a capacity provider may gain an agreement to supply generation through the Capacity Market and the processes by which the delivery body determines whether projects are eligible for the capacity market.
71. Box 4 sets out a simplified overview of how a new generator would become a capacity provider under the Capacity Market for the purpose of illustrating the end to end process⁴⁵.

Box 4: A capacity provider's journey

This box sets out a simplified overview of how a prospective new generator would become a capacity provider under the Capacity Market for the purpose of illustrating the end to end process. For this illustration we have taken the example of a new Combined-Cycle Gas Turbine (CCGT) of 500 MW situated in England and planning to connect directly to the National Transmission Electricity System

The project qualifies as a prospective generating unit, and, assuming it has capital expenditure above a defined threshold, would be eligible to bid for a longer term agreement (the proposed thresholds are £125/kW which would allow an agreement of up to 3 years and £250/kW which would allow access to a longer term agreement). In this example, it is assumed the project exceeds the £250/kW threshold.

Prequalification

The prospective generator would submit all the data required by the pre-qualification process to National Grid in an online application form for the CMU (The concept of a Capacity Market Unit (CMU) is explained in [Section 4.8](#)). The required eligibility criteria include: applicant information (such as legal status, bank account details, and portfolio structure), nomination and classification of CMU, low carbon support scheme status, and a certificate of ethical conduct.

The application needs to state whether it is for generating or DSR capacity and, as a new generator in this case, that it is classed as prospective generating capacity. As a new project it would qualify as a price-maker in the auction. The application would state the de-rating figure to apply to that CMU (from the range determined by the System Operator for that type of plant) and would also include details of construction milestones; together with evidence that planning permissions have been obtained

⁴⁵ For a better description of the processes and terminology used in this box, please see [Chapter 4](#).

and that a grid connection agreement is in force. As a prospective new generator, collateral is also required with the application (to the value of the termination fee payable if the project were to fail the financial commitment milestone noted below). The collateral would be returned if the applicant is unsuccessful in the auction or achieves the financial commitment milestone.

If information is missing, National Grid will inform the generator who may resubmit (as a new application) provided this is still within the Pre-qualification window.

National Grid will then assess the application and will notify the applicant whether it has pre-qualified and confirm its status as a prospective generating CMU and as a price-maker in the auction.

In the first instance an appeal in respect of a pre-qualification decision would be to National Grid, who would review the initial decision (for example for any errors in information processing).

Auction

In the auction, the prospective CMU may set its own bid price (subject to a price cap) and contract term length (up to a maximum limit on which we are consulting). As a new project which is assumed to seek a long term agreement, it would enter the 4 year ahead auction (there will be no option for long term agreements at the 1 year ahead stage). In the first bidding round, the CMU offers the full de-rated capacity and specifies the length of agreement required and, in each subsequent round, is then treated as automatically bidding its full de-rated capacity and for that same duration, unless it modifies the contract duration or confirms an exit bid. Each bid must be made on an electronic platform provided by the auctioneer, as per the auction guidelines.

If the generator is successful in the auction process, it will be awarded a Capacity Agreement for each CMU. National Grid will issue capacity agreement notices in respect of each successful CMU within 20 business days of the auction result and the capacity provider may then comment in writing as to the factual accuracy of the notice within 10 business days.

The capacity provider will be required to demonstrate that it has made a financial commitment to the project within a year of being awarded the Capacity Agreement (a minimum of 50% of the expenditure planned to have been incurred at that 12 month milestone). Failure to provide sufficient evidence would result in the termination of the capacity agreement and the application of a termination fee.

If the prospective new CMU is not completed by the start of the delivery year, capacity payments would be suspended until it becomes operational (although the agreement term will remain as the beginning of the delivery year). It would reach

substantial completion if more than 90% of the capacity is operational (the capacity obligation would be adjusted accordingly if less than 100% of the capacity is completed). The new CMU would not be liable for penalties until it has started to receive capacity payments.

If the new CMU does not have at least 50% of the capacity specified in its capacity agreement operational by 18 months after the start of the first scheduled delivery year, its capacity agreement would terminate and the provider would be liable for a termination fee. Such capacity would be eligible to participate in subsequent auctions, but as a price taker. If it has 50-90% of its capacity operational by the 18 month long stop date, it would have an additional 6 months to commission the full capacity and if not 100% complete by that stage would have its capacity figure adjusted to reflect the proportion of capacity operational at that 2 year point.

Secondary Trading

To manage the risk of exposure to CM penalties, the capacity provider will be able to trade its obligations both physically and through private financial hedging.

Physical trading will be possible at any point from one year ahead of the start of the delivery year, provided the assignee has pre-qualified and has no pre-existing obligations. As a new CMU, it may physically trade its obligations for the first delivery year in this way, but in order to do so for the second and third delivery years; it must have achieved full operational status prior to the year ahead date for that delivery year.

Financial trading through private markets will be possible at any time.

Delivery

In stress periods preceded by a capacity market Warning, capacity obligations will be based on the generator's intended position, up to four hours after the warning, or load following after this point, i.e. the CMU must respond to stress events by delivering electricity at the same percentage of their obligation as the rating assigned to the stress event. If the capacity provider fails to demonstrate the de-rated capacity over a delivery year, it will be liable to spot tests.

National Grid will issue a Capacity Market warning (CMW) four hours prior to an anticipated stress event. If the capacity provider fails to deliver sufficient energy at the relevant time of stress to meet its obligation, it will incur a financial penalty. Conversely, if it is able to over-deliver against its load following obligation during a stress event, it may be paid for the excess delivery. No penalties or over-delivery payments will apply for stress periods if a Capacity Market warning has not been issued.

The capacity provider's total penalty exposure in a delivery year will be capped (based on a multiple of the relevant auction clearing price multiplied by the MW capacity obligation). A soft cap will also exist in order to ensure providers always have an incentive to deliver in times of system stress. Both caps operate at a portfolio level, where relevant.

Settlement

Capacity providers will receive payment for capacity in the delivery year. Payment flows between suppliers and capacity providers will be managed by a settlement body assisted by a settlement agent. The settlement body will be responsible for monitoring the performance of the capacity provider through any period of stress. Where a capacity provider underperforms against its capacity obligation or provides excess volume, the settlement body calculates the resulting penalty charge or additional payment. The settlement body would be responsible for collecting any net charges/payments, which will be paid in 12 monthly instalments set using a weighting factor.

Table 1.2: List of Statutory Instruments

72. The following draft Secondary legislation is attached as an annex alongside this document.

List of Statutory Instruments	Summary of content
The Contracts for Difference (Allocation) Regulations 2014	<ul style="list-style-type: none"> • Draft definitions of eligible generators • Draft eligibility criteria • Draft controls on budget • Draft allocation processes • Draft appeal provisions
The Contract for Difference (Supplier Obligation) Regulations 2014	<ul style="list-style-type: none"> • General obligation of GB electricity suppliers to pay net costs of CFDs • Obligation of suppliers to pay annual fixed rate levy • Reconciliation of amounts • Payments to suppliers of amounts received from CFD generators • Obligation of suppliers to contribute to reserve fund • Obligation of suppliers to provide collateral and insolvency reserve collateral • Obligation of suppliers to contribute towards costs of CFD counterparty • Disputes and enforcement • Pro-rating of payments to CFD generators
The Electricity Capacity Regulations 2014	<ul style="list-style-type: none"> • Determining amount of capacity to auction and other auction parameters • Eligibility to participate in capacity auctions • Transitional provisions for Demand Side response • Information, enforcement and appeals • Duty of National Grid to produce annual electricity capacity reports

	<ul style="list-style-type: none"> • Power for the Authority to make or amend Capacity Market Rules
The Electricity Capacity (Payment) Regulations 2014	<ul style="list-style-type: none"> • Payment Model regulations <ul style="list-style-type: none"> – Compliance with settlement agent duties – Annual Forecast Budgets – Data Processing by the settlement agent – Provision of data – Capacity market calculations – Determinations and invoicing – Payment and non-Payment – Credit notes – Credit Cover in respect of non-payments – Dispute resolution – Reconciliation
Capacity Market Rules 2014	<ul style="list-style-type: none"> • Capacity Market rules

Chapter 3: Implementing Contracts for Difference

Section 3.1: Introduction	44
3.1.1 Scope of this chapter	44
3.1.2 Legal framework for Contracts for Difference	47
3.1.3 Further Policy Refinement.....	50
3.1.4 Roles and Responsibilities of Market Participants	50
Section 3.2: Narrative of Policy Framework	52
3.2.0 Lifecycle of a Contract for Difference.....	52
3.2.1 Phase 0: Setting the Framework and Transition to the CfD	53
3.2.1.1 Renewables Obligation Transition	54
3.2.1.2 Investment Contracts	55
3.2.1.3 The CfD Allocation Budget	57
3.2.1.4 Strike Prices.....	59
3.2.1.5 Route to Market.....	60
3.2.2 Phase 1: CfD Application and Allocation	60
3.2.2.1 Eligibility Criteria.....	62
3.2.2.2 Dedicated biomass Combined Heat and Power	63
3.2.2.3 Energy from Waste CHP	64
3.2.2.4 Supply Chain Standard	65
3.2.2.5 CfD Allocation.....	68
3.2.2.6 Tie-Breaker Rules.....	71
3.2.2.7 Phased Projects.....	72
3.2.2.8 Appeals provisions.....	72
3.2.2.9 Allocation Process in Legislation.....	73
3.2.3 Phase 2: From Contract Signature to Commissioning	76
3.2.3.1 Contract mechanics.....	77
3.2.3.2 Pre-commissioning Contract Management.....	80
3.2.3.3 Contract Capacity Adjustment	82
3.2.4 Phase 3: Post Commissioning Contract Management.....	83
Section 3.3: Payment Model and Supplier obligation	86
3.3.1 Start of the supplier obligation	89
3.3.2 Type of levy.....	89
3.3.3 The levy formula and unit cost fixed rate payment.....	92
3.3.4 Levy Reconciliation	95
3.3.5 Reserve Fund	96
3.3.6 Reserve Fund Reconciliation	98
3.3.7 Settlement Process for Suppliers and BSC registered Generators.....	99
3.3.8 Supplier collateral required through the Supplier obligation.....	102
3.3.9 Insolvency reserve fund – size and when this can be accessed.....	107
3.3.10 Mutualisation	110
3.3.11 Arrangements for dealing with non-payment	111
3.3.12 Disputes	113
3.3.13 CfD Payments from generators	115
3.3.14 Exemption for Energy Intensive Industries (EII)s.....	115

3.3.15 Counterparty operational cost levy	117
3.3.16 Setting the operational cost levy rate.....	118
3.3.17 Reconciliation of operational cost payments.....	121
3.3.18 Managing budget risk.....	121
3.3.19 Enforcement.....	121
3.3.20 Dispute resolution	122
Section 3.4: Implementing the CfD payment model	123
3.4.1. The CfD Counterparty	123
3.4.1.1 Roles of the CfD Counterparty.....	123
3.4.1.2 Governance and Constitution of the counterparty	124
3.4.1.3 The statutory framework for the CfD Counterparty.....	125
3.4.1.4 The Corporate Governance framework for the CfD Counterparty	125
3.4.1.5 The Constitutional Documents of the CfD Counterparty	126
3.4.1.6 Arrangements for the Operational Establishment of the CFD counterparty	126
3.4.2 Designation of the CfD Settlement Agent	127
3.4.3 Set-up of CfD Settlement Systems.....	128
Section 3.5: Next Steps	129
3.5.1 Developing Legislation	129
3.5.2 Devolved Administrations.....	129
Section 3.6: Summary of Contract for Difference Design Proposals	130

Section 3.1: Introduction

73. The Contract for Difference (CfD) scheme will work by stabilising revenues for generators. The CfD is a private law contract between a generator and the CFD Counterparty (counterparty), a Government-owned limited company.
74. The CfD is an agreement to pay the difference between the 'strike price' – a price for electricity reflecting the cost of investing in a particular low carbon technology- and the 'reference price' – a measure of the average market price for electricity at a particular point in time on the GB Grid.⁴⁶
75. Generators will receive revenue from selling their electricity into the market as usual. However, when the market reference price is below the strike price they will also receive a top-up payment from the counterparty for the additional amount. If the electricity prices are high and the reference price is above the strike price, the generator must pay back the difference to the counterparty, thereby reducing costs for suppliers and consumers.
76. The detailed arrangements for the CfD that have been published to date are specific to renewable technologies. We will continue to work on arrangements for CfD allocation for nuclear and Carbon Capture and Storage (CCS) technologies. It is important to note that the proposals set out in this Chapter regarding CfD allocation (including eligibility criteria, and allocation rounds) have been designed for 'generic' CfDs for which National Grid will administer eligibility and allocation. For such contracts we are proposing that Government will publish standard terms, and the counterparty body will be under a duty to offer a contract based on the standard terms (with some limited scope to modify these). Government will retain the power to direct the CfD Counterparty to enter into CfDs outside of these procedures.
77. CfDs will be introduced first in England, Wales and Scotland, with Northern Ireland opening its market to CfDs in 2016 at the earliest.
78. Further detail on arrangements for the Devolved Administrations is set out in Section 3.5 of this chapter. Whilst the Energy Bill seeks provision for CfDs to be issued to projects across the UK and outside the UK, the current scope of this document is limited to projects located in Great Britain.

3.1.1 Scope of this chapter

79. This chapter sets out the design of CfDs with the rationale for our design choices and includes a number of questions we wish to consult on. It also

⁴⁶ The reference price is calculated under the CfD using a formula designed to reflect a the market price of electricity in £ per MWh (produced using baseload or intermittent generation as applicable) for the relevant period.

sets out how we propose to give this policy legal effect, through the exercise of powers being sought through the Energy Bill.

- In November 2012 the Government published the *Feed in Tariff with Contract for Difference: Operational Framework*⁴⁷ and proposed *Heads of Terms for a Contract for Difference*⁴⁸ (CfD Heads of Terms). These documents set out the key design features for CfDs and provide an overview of the scheme. We continue to work with industry and various stakeholder groups, including our delivery partners, to develop a detailed CfD allocation process and to prepare more detailed draft CfD terms for later in 2013.
- In July 2013 the draft *Electricity Market Reform Delivery Plan*⁴⁹ set out draft strike prices for consultation. This consultation closed on 25 September and we intend to publish the final delivery plan in December 2013
- On 7 August 2013, we published a draft *EMR CfD Contract and Allocation Overview*, the *Electricity Market Reform Draft Contract for Difference*, *Contract for Difference: Allocation Methodology for Renewable Energy* and supporting documents⁵⁰. On this date we also published '*Supplier Obligation: policy update and response to the call for evidence*'⁵¹. These documents have been used to inform our on-going stakeholder engagement processes over the summer.

80. The August Allocation Methodology for Renewable Energy set out details of our proposals for: eligibility criteria, phasing, the CfD application and allocation process, appeals and our initial proposals for managing the CfD budget. In order to avoid re-stating information unless necessary throughout this chapter, where relevant we have referred back to the August methodology. Responses to the present consultation may wish to refer back to details set out in that previous publication when giving views on CfD

⁴⁷ https://www.gov.uk/government/uploads/system/uploads/attachment_data/file/65635/7077-electricity-market-reform-annex-a.pdf

⁴⁸ https://www.gov.uk/government/uploads/system/uploads/attachment_data/file/65636/7078-electricity-market-refrorm-annex-b.pdf

⁴⁹ https://www.gov.uk/government/uploads/system/uploads/attachment_data/file/223650/emr_delivery_plan_consultation.pdf

⁵⁰ Referred to as the 'August documents' <https://www.gov.uk/government/publications/electricity-market-reform-contracts-for-difference>

⁵¹ https://www.gov.uk/government/uploads/system/uploads/attachment_data/file/226897/CfD_Supplier_Obligation_-_policy_update_and_response_to_the_call_for_evidence_-_7_August_2013_-_FINAL.pdf

eligibility criteria, allocation methodology, appeals, phasing and capacity adjustment.

81. Further policy details published today include:

- More information about the requirement for some projects to have an approved Supply Chain Plan to be eligible for the CfD. This proposes that generators with projects over 300MW will need to demonstrate they have secured Government's approval to their supply chain plan as one of the eligibility criteria within the CfD allocation process.
- Further details on the CfD budget governance process and the way that this will inform the CfD allocation process.
- Full details of the mechanics and operation of the payment model for the CfD, including the supplier obligation levy.

82. We have regularly sought input from stakeholders and Delivery Partners during the development of CfD policy and processes including through:

- Contracts for Difference Expert group⁵²
- CfD Market Readiness Workshops⁵³
- Ongoing engagement with Devolved Administrations and Delivery Partners
- Collaborative development workshops; and
- Industry engagement events, bi-lateral engagement and industry fora, including a series of workshops in August 2013 to work through the detail of the contract and allocation rules.

83. This chapter is structured as follows:

- Section 3.2 of this chapter explains the lifecycle of CfD- from application, to allocation, contract management, payment and contract expiry.
 - Section 3.2.1 covers the transition from the Renewables Obligation, Investment Contracts (early CfDs), the CfD allocation budget, Strike Prices and Route to Market.
 - Section 3.2.2 sets out the process for applying for a CfD, the eligibility criteria and the method for allocation of CfDs, as well as details of phased projects and appeals provisions.
 - Section 3.2.3 describes the CfD contract terms, processes for varying the contract, and the way that the contract will be managed before the plant has commissioned.

⁵² <https://www.gov.uk/government/policy-advisory-groups/contracts-for-difference-emr-expert-group>

⁵³ <https://www.gov.uk/government/policy-advisory-groups/electricity-market-reform-emr-cfd-market-readiness-working-groups>

- Section 3.2.4 covers post-commissioning management of the contract.
- Section 3.3 outlines the payment model for the CfD and sets out the detail of the way that the supplier obligation levy will operate.
- Section 3.4 includes a description of the institutional arrangements for delivering CfDs.
- Section 3.5 covers the next steps for developing legislation and further engagement with the Devolved Administrations.
- Section 3.6 summarises the overall design of Contracts for Difference.

3.1.2 Legal framework for Contracts for Difference

84. The Contract for Difference regime will be put in place by the Secretary of State under the powers conferred by the Energy Bill and implemented through a combination of secondary legislation and the CfD Allocation Technical Framework which will accompany the secondary legislation. Supporting the secondary legislation and the Allocation Technical Framework will be detailed administrative guidance published by National Grid, the CFD Counterparty Framework Document and the CfD contract terms⁵⁴.
85. This approach will enable the Government to retain accountability for key aspects of the CfD regime, while ensuring that the CfD contracts provide the legal certainty that investors in low-carbon generation projects require.
86. The regulations, which will be made by the Secretary of State, cover a number of aspects of the CfD. A summary of the draft statutory instruments that relate to CfD published alongside this document can be found in Table 3.2 below.
87. We intend to produce CfD regulations which set out the circumstances in which the Secretary of State can prepare and publish a CfD and the circumstances in which the CFD Counterparty can amend the terms. The CfD contract terms were published in draft form in August. We are now considering responses from stakeholders and intend to publish an updated contract by the end of 2013.
88. In addition, the Secretary of State will have the power to produce a detailed Allocation Technical Framework (ATF). The ATF is expected to contain the legal framework for the allocation of CfDs. We are currently considering in detail how the provisions will be split between the regulations and the ATF, subject to the will of Parliament. Examples of how the split might work are set

⁵⁴ We are intending to bring forward amendments to the Energy Bill to enable an allocation framework to be prepared which will contain technical and budgetary detail for the allocation process

out in Table 3.2 below, although please note that this is subject to further deliberation in light of legislative changes that we hope to make.

89. The Allocation Technical Framework will include technical rules, details and procedures that enable the Contracts for Difference allocation process to operate efficiently and flexibly. We anticipate that the requirements set out in the ATF will be implemented by the EMR delivery body and enforced by Ofgem.
90. The Allocation Technical Framework will be published before the start of the allocation process. We will engage early with stakeholders on the development of the ATF, building on the policy set out in the Allocation Methodology, and the views already received on the proposals contained in that document. We intend to publish a draft Allocation Technical Framework early in the new year for the benefit of industry and delivery partners to consider, and will publish a final ATF for the first CfD allocation round in late spring 2014, which is approximately the time that we expect to be laying in Parliament the implementing regulations.
91. In preparing the Allocation Technical Framework, subject to any legal constraints on the sort of provision which can properly be included in the Allocation Technical Framework, the Government will bear in mind any consultation responses which bear on what should be included in the Allocation Technical Framework. Similarly, in due course, if and when a need arises to amend the Allocation Technical Framework the Government will aim to involve affected stakeholders on substantive changes of policy unless a change is urgently needed. For example, if a change is required to preserve the integrity of an on-going allocation process or in order to stop gaming that has been identified it may not be practicable to undertake a consultation before effecting a change. However, where possible and appropriate, the Government will consider consulting with potentially affected stakeholders before a change to the Allocation Technical Framework is made.

Table 3.1: List of draft Statutory Instruments and further detail on Secondary legislation

- Allocation Mechanism regulations setting out the requirements of the allocation process (including eligibility and allocation).
- Supplier obligation regulations.

Table 3.2: Proposals for the types of provision for the CfD allocation

regulations and the Allocation Technical Framework⁵⁵

Proposed Content for Regulations	Proposed Content for Allocation Technical Framework
<ul style="list-style-type: none"> • Definitions of eligible technologies. • Eligibility criteria for generic CfDs, including requirements; an approved supply chain plan and project identifying information, e.g. location. 	<ul style="list-style-type: none"> • Detailed description of evidence required from generators to demonstrate eligibility. • Detailed description of other information required from applicants to complete CfD, e.g. fuel energy content for biomass and EfW.
<ul style="list-style-type: none"> • Eligibility of phased CfDs for certain projects. • Treatment of phased projects in constrained allocation. 	<ul style="list-style-type: none"> • Additional information on stages and timetable for a phased CfD. • Contract milestones for phased projects.
<ul style="list-style-type: none"> • Definition of First Come First Served (FCFS) and Allocation Rounds. Description of the trigger for moving from one to the other. • Frequency of Allocation Rounds. 	<ul style="list-style-type: none"> • Precise trigger for moving from FCFS and detailed process for EMR delivery body to follow.
<ul style="list-style-type: none"> • Power to vary generic CfD budget, including restrictions on doing so within an Allocation Round. • Optional use of maxima and minima within this budget. 	<ul style="list-style-type: none"> • Where and the format in which generic CfD budget information and current usage is published. • Methodology for valuing CfDs.
<ul style="list-style-type: none"> • The basis upon which to ration under constrained allocation (i.e. by price, subject to minima and maxima) 	<ul style="list-style-type: none"> • Precise process for allocation. • Auction method to be used in constrained allocation. • Tiebreaker rules. • Subsequent use of bid information.
<ul style="list-style-type: none"> • Key elements of appeals process. • Minimum time allowed for appeals 	

⁵⁵ Final details of split will be subject to review.

at each stage.	
<ul style="list-style-type: none"> • Target Commissioning Windows and Longstop Dates for each technology. 	<ul style="list-style-type: none"> • Rules on Substantial Financial Commitment and Capacity Adjustment given effect through the Contract.

3.1.3 Further Policy Refinement

92. We received 55 responses to the Allocation Methodology and Allocation and Contract overview documents published in August, and have used this input to further refine and develop our thinking on the CfD allocation methodology and contract terms.
93. Through a process of collaborative development workshops with industry and delivery partners during autumn 2013, we will be testing the way that allocation, contract allocation and budget management will work in practice. These workshops will not seek to further develop policy on these issues, but will focus on refining the processes that generators and suppliers will follow when the CfD scheme is in place. More information about collaborative development is provided in Chapter 7 of this document including web links to the full programme of workshops.
94. In parallel, we will also be undertaking further work with the CfD Expert group on key policy issues including: Substantial Financial Commitment Milestone, phasing and capacity adjustment.
95. We will use outputs of CfD collaborative development workshops, along with further engagement with the CfD Expert Group and other stakeholder engagement to inform aspects of the CfD design.

3.1.4 Roles and Responsibilities of Market Participants

96. Throughout this chapter, reference is made to key participants in the CfD allocation and administration processes. Table 3.3 below summarises the participants and the key responsibilities of each.

Market Participant	Roles and Responsibilities under CfD
Government	<ul style="list-style-type: none"> • Oversight of policy effectiveness of the CfD mechanism. • Sets the terms of the CfD contract and can vary terms for

	<p>contracts issued in future.</p> <ul style="list-style-type: none"> • Sets the objectives for the allocation system. • Responsible for the overall budget (policy costs) of the CfD scheme. • Responsible for approval of supply chain plans and final approval of planning permission for new developments over 50 MW (power to grant planning consent for generation above 50MW in Scotland is devolved.) • Sets out some information that applicants must provide and further eligibility criteria for phased projects. • Secretary of State ultimately decides when CfD allocation moves from First Come First Serve to rounds and sets auction rules, including tie-breaker rules. • Sets out the standard terms of the CfD contract. • Has power to vary the generic CfD contract terms before a contract is offered. Potential to negotiate some Investment and CfD contracts. • Has power to issue contracts direct where appropriate. • Sole shareholder of the Counterparty. • Reviews and approves Counterparty annual operational budget and sets rate to cover this in legislation. • Allocates non-generic CFDs.
National Grid (EMR delivery body)	<ul style="list-style-type: none"> • Assesses the eligibility of applications for generic contracts⁵⁶ which the counterparty will then sign with generators. • Runs the constrained allocation process in the event of the value of applications exceeding the available budget. • Provides the counterparty with the information necessary to offer a contract. • Conducts analysis to support Government's setting of strike prices. • On-going reporting of applications against generic CfD Budget.
CfD Counterparty	<ul style="list-style-type: none"> • Contracting party with generators for the CfD. • Signs CfDs once provided with the necessary information by the EMR delivery body or directed by the Secretary of State; management of Investment Contracts which are transferred from Secretary of State. • Provides Government with ongoing updates on project status, including milestones achieved, budgetary consequences and any delays. Responsible for acting as interface with generators and managing the contract. • Considers any minor and technical amendments to the contract standard terms.

⁵⁶ That is, CfDs which are not allocated directly by the Secretary of State.

	<ul style="list-style-type: none"> • Forecasts supplier obligation in accordance with the Supplier obligation regulations. • Collects payments from suppliers and passes to generators and vice versa (the Counterparty is expected to contract part of this role out to ELEXON who will act as settlement agent), and in doing so holds and manages reserve funds (security for the scheme). • Responsible for ensuring payments are settled between generators and suppliers. • Debt recovery will be carried out by the Counterparty.
Ofgem	<ul style="list-style-type: none"> • Ensures that the EMR delivery body carries out its duties efficiently, cost effectively and in a timely fashion. • It is proposed that Ofgem addresses certain types of appeal that can be brought against aspects of the operation of the CfD scheme.
Electricity generators	<ul style="list-style-type: none"> • Responsible for submitting the CfD application, together with appropriate supporting evidence against the eligibility criteria (including supply chain plans). • Responsible for delivering their project and complying with the terms of the contract.

Section 3.2: Narrative of Policy Framework

3.2.0 Lifecycle of a Contract for Difference

97. Figure 3.1 below sets out an overview of the lifecycle of a CfD, from setting the initial policy framework and bringing this into effect through the Energy Bill and secondary legislation, to the processes by which generators can apply for a CfD, through to contract allocation and management of the CfD contract by the counterparty. Full descriptions and details for each phase are set out in the following sections.

Figure 3.1: Lifecycle of a Contract for Difference

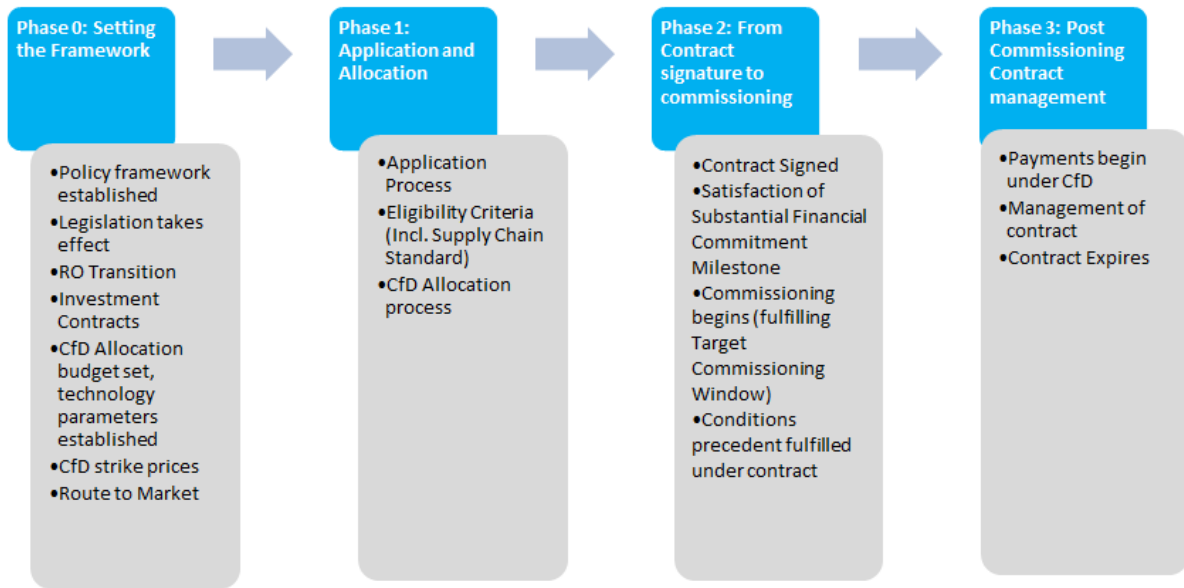

3.2.1 Phase 0: Setting the Framework and Transition to the CfD

Figure 3.2

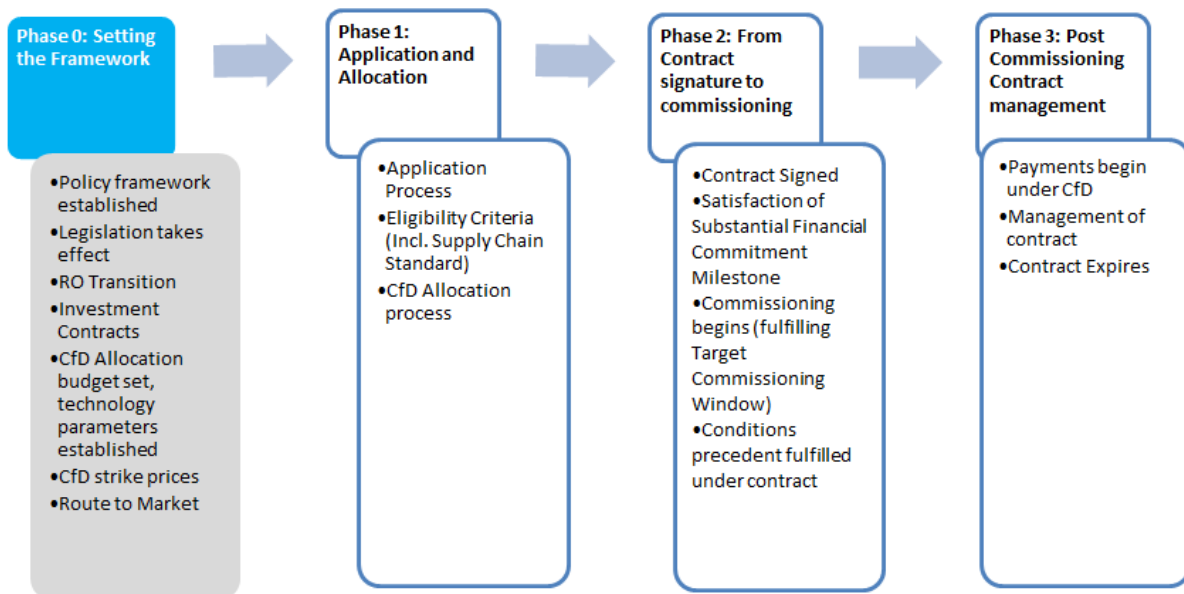

Summary:

- In Phase 0 (2012 to July 2014) the Government will set the framework for CfDs and begin the transition to the new regime, including managing the interface with the Renewables Obligation and Investment Contracts.

- This will be achieved by establishing the responsibilities of each of the bodies involved in allocating and managing CfDs in legislation and framework documents; through defining the detailed contract terms and publishing the contract and through establishing allocation arrangements through the Allocation Technical Framework document. Secondary legislation will be laid before Parliament in late spring 2014, and subject to the Parliamentary timetable we intend that it will be in effect by July 2014.
- The Levy Control Framework (LCF), a cap on the maximum amount of public spending allowable through consumer bills to support Government's electricity market decarbonisation objectives. We are considering methods to ensure the CfD budget is well managed within the LCF.
- Initially, CfDs will be allocated with strike prices that are set administratively (i.e. set by Government), moving to competitive price discovery processes for all low-carbon technologies as soon as practicable.
- Government has amended the Energy Bill to seek further measures to support independent renewable generators to find routes to market. These measures will be consulted upon in the next few months

98. The Energy Bill includes provisions to ensure that the transition from the Renewables Obligation to the CfD does not result in a hiatus in investment. Powers in Chapter 4 Part 2 and Schedule 2 of the Energy Bill seeks to allow the Secretary of State to give effect to early CfDs – referred to as 'Investment Contracts' – with the intention that these contracts will be transferred to the counterparty once it is established.

3.2.1.1 Renewables Obligation Transition

99. Arrangements for the transition from the Renewables Obligation (RO) to CfDs were put forward for consultation in on 17 July⁵⁷, and closed on 25 September. We are now considering responses to this consultation, and will publish a Government Response before the end of 2013. At this early stage, we cannot confirm whether any policy within that consultation has changed on the basis of responses to the consultation. Policy as set out within that consultation is described in brief below.
100. During the period of transition from RO to CfD (second half of 2014 to March 2017), new generating capacity will have a choice between the RO and CfD schemes.

⁵⁷ <https://www.gov.uk/government/consultations/transition-from-the-renewables-obligation-to-contracts-for-difference>

101. Additional generating capacity of more than 5MW at an existing RO-accredited generating station will also be eligible to choose which scheme is applied to during the transition period, and will continue to be entitled to apply for a CfD after the transition period ends. Where a generating station has some capacity within the RO and some covered by a CfD, it will be termed a **'dual scheme plant'**, and we propose that it will be subject to additional metering requirements, to ensure that generation within each scheme is measured accurately. Additions of capacity of 5MW or less at existing RO-accredited stations will not be eligible to apply for CfDs, as Government considers that the administrative complexity of dual scheme plant arrangements would be unsuitable for small-scale capacity additions.
102. On 31 March 2017, the RO will close to new capacity, and will then continue running in support of accredited capacity for a further 20 years, until 31 March 2037. We will offer grace periods for operators who expected to deploy prior to the RO closure date, but were delayed, ensuring that such operators are still able to accredit under the RO when it is appropriate that they should do so. The RO Transition consultation proposed key principles to be used as the basis for defining the precise length, evidence and eligibility criteria for these grace periods.
103. There are two transition measures which are specific to particular technologies: biomass co-firers, and offshore wind. To incentivise RO-accredited biomass co-firers to convert to full biomass firing, we propose that they would be able to apply for a CfD as a biomass conversion, and to withdraw from the RO as a co-firer if successful. This option would be available for full stations and for units or groups of units within stations. In addition, co-firers will be able to bid in to the Capacity Market, and to withdraw from the RO if successful. In both cases, stations or units would not be able to return to the RO once they have made this choice. Operators of offshore wind stations who have not yet registered all phases of their RO-accredited capacity will be entitled to register those remaining phases under the RO on or before the closure date, even if the phases have not yet commissioned or they will be entitled to apply for a CfD for the unregistered phases.

3.2.1.2 Investment Contracts

104. Government recognises that in the period before the CfD goes live generators may delay investment decisions. Investment Contracts are Government's policy to address this risk of an investment hiatus. Investment Contracts will work by enabling the Secretary of State to give effect to an early form of the Contract for Difference with investors who wish to commit funds before the CfD is fully established. Investment Contracts will be subject to the relevant powers in the Energy Bill gaining Royal Assent, and a positive decision on State Aid by the European Commission. The first Investment Contracts are expected to be signed in late spring 2014 under Final Investment Decision Enabling for Renewables (FIDeR).

105. A number of generators have expressed interest in the process of Final Investment Decision enabling through Investment Contracts. The UK Government is in negotiations with NNB GenCo (a subsidiary of EDF) about a potential Investment Contract which might enable their final investment decision on the Hinkley Point C new nuclear power plant project. Government has also received applications for Phases 1 and 2 of FID Enabling for Renewables which cover a wide range of renewables technologies, and expressions of interest from early stage Carbon Capture and Storage projects.
106. Chapter 4 of Part 2 and Schedule 2 to the Energy Bill set out provisions, which are intended to give effect to Investment Contracts. The key components of these powers are the following:
- **Mitigation against delays and payments to generators** -The provisions in Schedule 2 seek powers for the Secretary of State to fund Investment Contracts (either by direct payment or by collecting money from suppliers). The supplier obligation provisions mirror to a large extent those in Chapter 2 of Part 2 of the Bill on CfDs. These powers are designed to give investors' confidence that payments under an Investment Contract will be honoured, even if the enduring EMR regime is delayed significantly or does not come into force at all.
 - **Investment Contract Counterparty** – under the Bill the Secretary of State would have the powers to create an Investment Contract Counterparty to administer Investment Contracts, which would be similar to the counterparty envisaged under the enduring EMR regime.
107. Schedule 2 of the Bill also seeks powers for the Secretary of State to transfer Investment Contracts (by transfer scheme) to the counterparty under the enduring EMR regime, and a regulation making power under paragraph 16(2) to treat Investment Contracts which have been transferred as CfDs for the purpose of provision made under the CfD Chapter of the Bill. This allows Investment Contracts to be administered and funded by the counterparty in the same way as other CfDs. In the ordinary course of events, therefore, Investment Contracts will be transferred to the counterparty, and we do not envisage having to make Regulations under Schedule 2, except for regulations under paragraph 16(2) in relation to Investment Contracts which have been transferred.
108. The Bill includes a duty (in certain circumstances) to transfer Investment Contracts to the counterparty once the following conditions are met:
- the Investment Contract powers expire (1 Jan 2016 or earlier if CfD regulations define an 'eligible generator');
 - the counterparty is designated; and
 - supplier obligation regulations are in force.

109. It is anticipated that these conditions could be in place as early as July 2014. Therefore, in order to ensure that Investment Contracts can be administered and funded by the counterparty, Regulations under clause 16(2) would need to be in force at the same time as the contract is transferred, and ideally at the same time as the EMR Regulations that form the trigger for the duty to transfer come into force. The draft supplier obligation regulations published alongside this document therefore include provisions to treat Investment Contracts as CfDs for the purpose of the Regulations.

Investment Contracts	
Question CFD1	<ul style="list-style-type: none"> Do you agree with the approach outlined in section 3.2.1.2 of this document to treat Investment Contracts as CfDs once they have been transferred to the CfD Counterparty in order to allow the counterparty to administer and fund these contracts in the same way as CfDs?

3.2.1.3 The CfD Allocation Budget

110. The Government's Levy Control Framework (LCF) cap represents the maximum amount of public spending allowable through consumer bills to support Government's electricity market decarbonisation objectives.⁵⁸ It is expressed as a series of annual limits on the overall costs of support across a number of schemes. These schemes include the Renewables Obligation, Small Scale Feed In Tariffs (FIT), Investment Contracts and CfDs. The proportion of the LCF allocated for each scheme is described as a 'budget'.
111. The Government is developing a governance mechanism to monitor and manage the risk of over and underspend within the LCF, including the allocation and reallocation of budgets for particular schemes within the LCF. Further details of how Government will manage the LCF will be published in the Delivery Plan scheduled for December 2013.
112. Table 3.4 below shows the upper limits to low carbon electricity policy levies agreed under the LCF.

Table 3.4: LCF for Low Carbon Levy Funded Schemes, 2011/12 prices⁵⁹.

⁵⁸ Annex D of the draft Delivery Plan provides further details of how the Levy Control Framework has been extended to 2020/21 to support Electricity Market Reform.
https://www.gov.uk/government/uploads/system/uploads/attachment_data/file/223654/emr_consultation_annex_d.pdf

⁵⁹ Figures are not cumulative.

2015/16	2016/17	2017/18	2018/19	2019/20	2020/21
£4.30bn	£4.90bn	£5.60bn	£6.45bn	£7.00bn	£7.60bn

113. From within these overall annual limits, and taking account of the other schemes supported through the LCF, the EMR delivery body will be provided with a budget that it can allocate to CfD participants, we refer to this as the 'CfD budget'. Indicative budget levels for the years 2014-15 to 2018-19 will be included in the Delivery Plan⁶⁰.
114. The need to manage the costs imposed on consumers and the LCF constraints make it necessary to have controls over the CfD budget whilst providing as much certainty as possible to generators. The principle budget control measures will be:
- a) The design of the allocation process set out at section 3.2.2.5 below.
 - b) We are considering the possible use of minima (floors) or maxima (caps) placing restrictions on allocation of the CfD budget for some technologies or technology groups. A minima would effectively reserve a portion of the CfD budget for a technology or group of technologies while a maxima would constrain a portion of the CfD budget available for a technology or group of technologies.
115. Subject to the will of Parliament, the Government will establish the budget for generic CfDs and set this out in the Delivery Plan. Regulations will establish the ability of the Government to vary the generic CfD budget, including restrictions on doing so within an Allocation Round and establish the potential for optional use of maxima and minima within this budget.

Changes to the CfD Allocation Budget

116. The Government has the ability to adjust the CfD budget. Where it does so Government will issue updated values to the EMR delivery body as these will act as the basis for the EMR delivery body to determine CfD allocation.
117. Government will have the ability to *increase* the CfD budget limit at any time, including during an Allocation Round. This flexibility would come from managing the interdependencies between the CfD and other budgets within the LCF as described above.
118. To provide investors with certainty that budget will not be removed just before they apply for a CfD, Government will not be able to *reduce* the budget for applicants *within* an Allocation Round – all applicants to a round will be

⁶⁰ We also propose that this will be in the proposed Allocation Technical Framework.

assessed against a budget that is at least as high as that which was in place when the round opened for applications.

119. The Government will inform the Devolved Administrations (DAs) ahead of amending budget parameters, and will aim to involve them as far as is possible. In particular we will aim to do so where decisions will impact technologies in which DAs have a particular interest. There may be a limited number of circumstances in which we will reserve the ability to make quick decisions where it is in the public interest to control costs; for example if the allocated budget had to be reduced very suddenly in order to address gaming risks or pressures elsewhere in the LCF. In these circumstances the DAs will be informed, but further involvement may not be practicable.

Publication of Budget Information

120. Market participants need to know how much of the CfD budget is available so that they can make informed choices about their project development spending. The EMR delivery body will provide this information via a website during both the First Come First Served (FCFS) stage of the allocation process and in allocation rounds (see section 3.2.2.5. for a description of the allocation process).

3.2.1.4 Strike Prices

121. Initially, CfDs will be allocated with strike prices that are set administratively (i.e. set by Government).
122. The Government intends to move to competitive price discovery processes for all low-carbon technologies as soon as practicable, and the allocation processes described in this document are designed to support a move to competitive price discovery as soon as this is possible.
123. We anticipate that the CfD Allocation Technical Framework will set out the detail of the allocation processes including explaining how Government may use any cost information provided by developers in support of their applications.

CfD Budget	
Question CFD2	<ul style="list-style-type: none"> Do you agree that Government should be able to increase the budget allocation to the EMR delivery body without further consultation, but should be restricted from reducing this for applicants within an allocation round?

Question CFD3	<ul style="list-style-type: none"> Do you have any comments on the use of minima and/or maxima budgets, the case for technology-specific and general auctions, and how they might best support value for money and the management of the CfD budget (within the LCF)?
----------------------	--

3.2.1.5 Route to Market

124. The Government has also established two working groups, comprised of industry and consumer experts, to create products⁶¹ that will prepare independent renewable generators for the introduction of CfDs. Government has also amended the Energy Bill to seek further measures to support independent renewable generators. These measures will be consulted upon in the next few months, and any secondary legislation required would be brought forward in spring 2014. Further detail is set out in Annex B.

3.2.2 Phase 1: CfD Application and Allocation

Figure 3.3

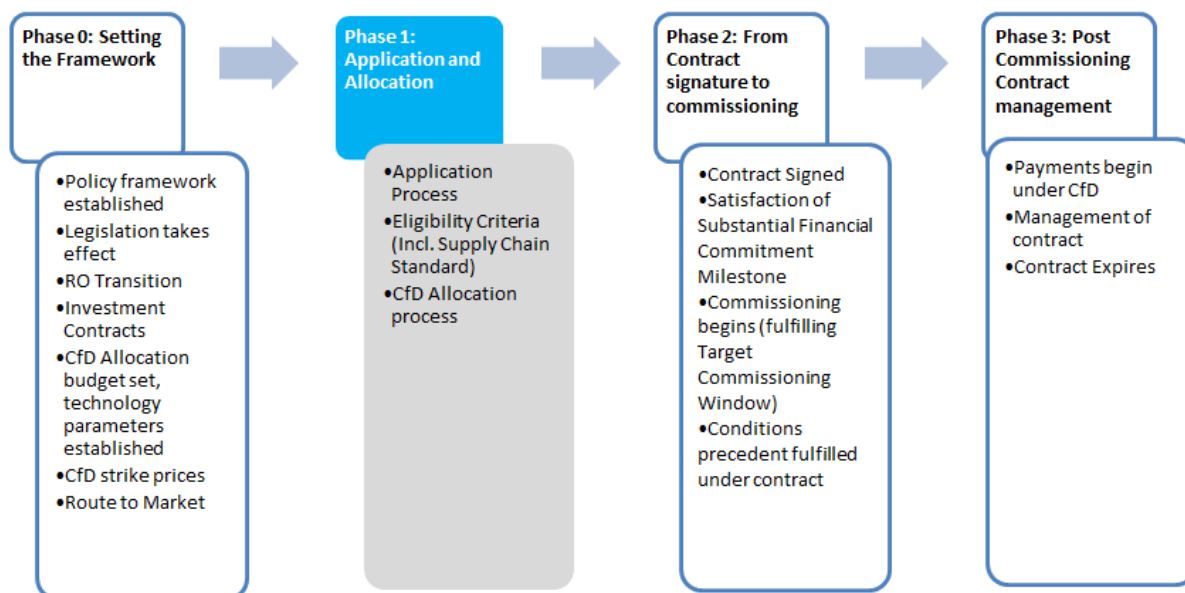

⁶¹ Including an example Power Purchase Agreement (PPA) contract under the CfD, and best practice guidelines for new entrants.

Summary:

- In Phase 1 (from the second half of 2014 onwards), generators will be able to apply for a CfD. This section sets out the eligibility criteria that we propose a generator will be assessed against, including a proposal for that projects of 300MW and above should submit an approved supply chain plan when making an application for a CfD.
- Eligible generators apply to the EMR delivery body for generic CFDs, who will then determine to whom contracts should be allocated and provide information to the counterparty to offer contracts.
- Allocation of Contracts will begin on a First Come First Serve basis, moving to allocation rounds once at least 50% of the budget is used (unless the Secretary of State decides to move to allocation rounds once a higher percentage has been used).
- The duration of the First Come First Served phase of allocation will be impacted by wider decisions on the use of the LCF cap.
- The Counterparty will award contracts to successful applicants.

125. On 7 August 2013, Government published *Contract for Difference: Allocation Methodology for Renewable Energy* setting out in detail the process that generators must go through in order to secure and then retain a Contract for Difference⁶². In considering the consultation questions in this section, you may wish to refer back to that document. Figure 3.4 below shows the journey a project will progress through from application through to operation.

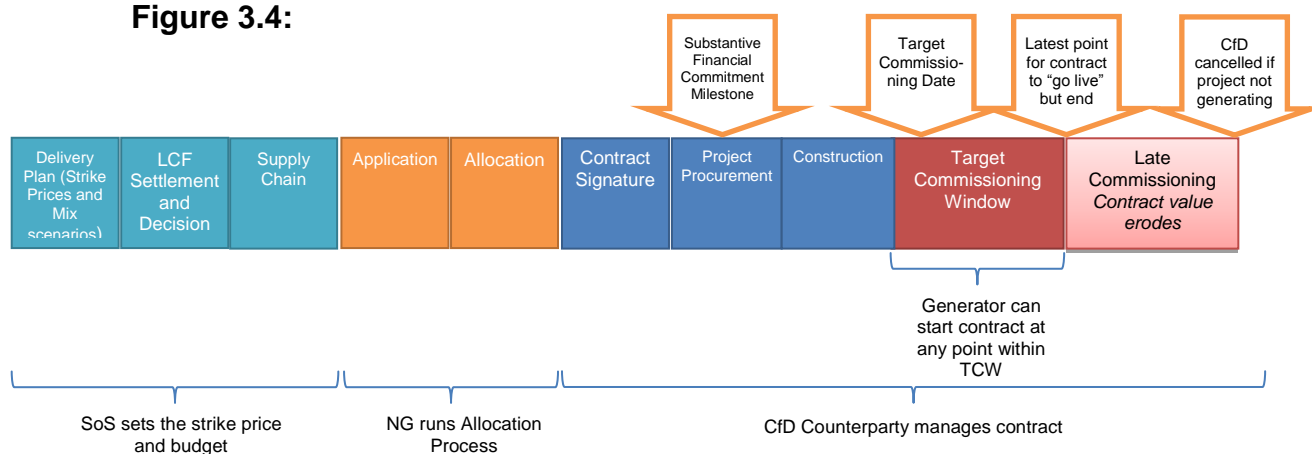
Figure 3.4:

62

https://www.gov.uk/government/uploads/system/uploads/attachment_data/file/226976/Allocation_Methodology_-_MASTER_-_6_Aug_v_FINAL.pdf

3.2.2.1 Eligibility Criteria

126. A number of eligibility criteria have to be met before the EMR delivery body will determine whether the project qualifies for a CFD for generic CfDs; and our proposals for these were first set out in detail in the August documents. Government is continuing to work with industry to identify the documents that will enable the EMR delivery body to judge accurately whether the criteria have been met. The criteria that a project will have to meet are set out below:
- That the project is for a qualifying form of low carbon generation. The detailed criteria for qualifying technologies are set out in detail in the table at **Annex D** to this document;
 - In the case of technologies eligible for the small-scale Feed-In Tariff,⁶³ the installed capacity is greater than 5MW;
 - Planning permission or development consent has been given for the proposed generating station under the appropriate consenting regimes as set out in the detailed criteria in the Allocation Methodology in August;
 - The applicant is validly incorporated under the laws of the jurisdiction in which it is incorporated⁶⁴;
 - Where relevant a company's supply chain plan has been approved by Government;
 - Information that enables the CfD to be drafted, including project details and location and information to enable the relationship between the Renewables Obligation (RO) and CfD to be properly structured, e.g. that a Fuel Measurement and Sampling Agreement will be concluded; evidence that the applicant is not applying for or in receipt of other Government support for the proposed generating capacity and the administrative strike price for the project's technology; and
 - a Grid Connection Offer has been accepted.
127. As part of their application generators are allowed to provide sealed bids containing the strike price they would be willing to accept for the project if an allocation constraint was triggered (although this is not obligatory; if not provided, the default bid price will be the administrative strike price).
128. Additional evidence may be required for some project types or technology classes.

⁶³ Anaerobic Digestion, Hydro, Onshore Wind, Solar PV.

⁶⁴ Reference to incorporation in this case should relate to the formation of a business entity and should not be taken to refer only to companies.

129. Annex D sets out renewable technologies that are considered eligible for CfDs at present. Definitions of these and the associated fuels which can be used for fuelled renewable technologies will be in the regulations and will be based upon those under the Renewables Obligation (RO), adjusted in some cases to acknowledge differences between the two schemes.⁶⁵
130. Application cannot be for generating capacity that has previously applied for the RO and been accredited– with the exception of co-firing plant intending to apply for a CfD as a biomass conversion.
131. Failure to meet any of these eligibility criteria will result in the EMR delivery body rejecting the application.
132. Applicants for CfDs will be required to provide the EMR delivery body with evidence that the proposed project meets the eligibility criteria. We anticipate setting out in guidance what form such evidence would be expected to take.
133. Applicants will be permitted to make one application for each specific project at a time (but may submit applications for several different projects at the same time). Applications for a particular project can be resubmitted, but only after any previous application for that project has been assessed by the EMR delivery body.
134. We understand that these eligibility criteria may need to be adapted to reflect the particular circumstances for Northern Irish generators. We would welcome stakeholder feedback through the consultation question below and further evidence on this issue to assist in refining plans for implementing CfD in Northern Ireland.

3.2.2.2 Dedicated biomass Combined Heat and Power

135. We indicated in the draft delivery plan that we would offer a flat strike price for good quality dedicated biomass Combined Heat and Power (CHP). In order to be eligible for support, generating plants will need to provide a certificate from the Combined Heat and Power Quality Assurance (CHPQA) programme confirming that the plant either partially or fully qualifies under the CHPQA criteria.
136. Plants will need to maintain their CHPQA certification annually once operating and for the duration of any CfD offered in order to continue to receive support.

⁶⁵ We propose to use a simplified definition of biomass to that used in the RO to ensure there is no ambiguity in what is categorised as an energy from waste plant and what is a dedicated biomass plant. This reflects the policy intention for dedicated biomass with CHP plants to be able to use waste where the fossil-derived 'contamination' is under 10% of the biomass fuel used in a month, and for waste plants to be able to use non-waste biomass. In line with the RO, facilities using biomass fuels will only be paid on the renewable/ biomass proportion of the fuel used in a given month, on an energy content basis.

Support under the CfD will be paid on the proportion of their metered electrical output assessed by CHPQA to be Qualifying Power Output (QPO) only, i.e. the portion of electrical output that can be considered “good quality”. This is to ensure that support is provided for genuine CHP projects only, in line with our decision not to support electricity-only dedicated biomass and in line with the requirements of the new Energy Efficiency Directive.

137. It is our intention to use the Guidance Note 44 (GN44) definition of QPO, which is also used under the Renewables Obligation. This has been specifically designed for renewable CHP schemes, recognising that they inherently have lower overall efficiencies than gas CHP. In July 2013 we decided to update the GN44 requirements as from 1 Jan 2014. We will keep the need for further periodic updates of GN44 requirements under review for new plant to reflect technological developments. The updated GN44 QI formulae are grandfathered for new schemes from the date of their CHPQA certification. This is subject to any changes that may be required by EU law and details are set out in the Government response to the consultation on reviewing the qualification criteria for renewable Combined Heat and Power schemes⁶⁶.
138. We recognise concerns that a CHP plant could lose heat customers through no fault of its own, resulting in a lower Qualifying Power Output and reduced CfD support, or even loss of support. To help mitigate this risk, Government proposes to introduce a safeguard, whereby support will be paid for the first five years on the QPO as assessed in the CHPQA design certificate i.e. the certificate issued on the basis of the plant’s “F3” design submission. This will be audited in the first year of operation. In the event that the audit finds that the plant has not been constructed in line with the design submission, or its electrical efficiency is significantly different from that declared, an amended design certificate will be issued. From year six onwards, support will be paid on the QPO recorded on the annual certificate. The generator will be required to provide evidence of their intended heat load, e.g. a Business case, Contract or Memorandum of Understanding, in their design submission. It will not be sufficient for plant to be simply “CHP ready” without clear plans to supply heat.

3.2.2.3 Energy from Waste CHP

139. For Energy from Waste CHP we propose to mirror the arrangements in place under the Renewables Obligation, which are that support under the CfD will be paid only on the proportion of metered electrical output assessed by CHPQA to be Qualifying Power Output, that is the portion of electrical output that can be considered “good quality”. It is our intention to continue to use the

⁶⁶https://www.gov.uk/government/uploads/system/uploads/attachment_data/file/211917/D13_813935_CHPQA_Consultation_Government_Response.pdf

Guidance Note 44 (GN44) definition of QPO. Plants will need to maintain their CHPQA certification annually once operating and for the duration of any CfD offered in order to continue to receive support.

Eligibility Criteria	
Question CFD4	Do you agree with the proposed eligibility criteria set out at Annex D ? Do you have any further comments that should be taken into account in finalising these eligibility criteria (you may wish to refer to the August Allocation Methodology document)?
Question CFD5	Do you have any further comments that should be taken into account in finalising eligibility criteria for Northern Ireland?
Question CFD6	Do you agree with the eligibility criteria for dedicated biomass CHP and the decision to offer the strike price for Qualifying Power Output only? Do you agree with the proposed five year safeguard measure? Do you agree with the use of Guidance Note 44? Do you agree with the approach to Energy from Waste CHP?

3.2.2.4 Supply Chain Standard

140. Government has decided to make the provision of an adequate supply chain plan a pre-condition for the CfD allocation process for larger projects. We propose that projects that are applying to develop capacity of 300MW or above will need to provide the EMR delivery body with a letter from Government certifying that they have an approved supply chain plan when making an application for a CfD. Supply Chain plans will set out how the project will support the long term economic growth and viability of the global low carbon supply chain and how they will foster innovation and competition and support the development of skills in that chain. The Government considers that encouraging open and competitive supply chains and promoting innovation and skills in them will drive down the cost of low carbon

generation over the long term and result in lower energy costs to consumers⁶⁷.

141. The supply chain plans will be assessed by Government on the basis of whether the plan demonstrates enough action is being taken, or has been taken, by the generator to deliver the Government's objectives, as well as sufficient evidence to prove these actions will be/have been undertaken.
142. We are minded to implement the supply chain plan requirement through a combination of regulations and guidance. The provisions for the supply chain plan requirement will be included in the final version of regulations to be laid in 2014, and are not currently included in the draft statutory instrument.
143. Government will issue a consultation on our detailed proposals in November; we expect that this consultation will close on the same date as the present consultation. This consultation will set out the information that a supply chain plan will need to include, as well as the criteria that they will be assessed against, and how each plan will be assessed. The outcome of this consultation will be a combination of regulations and detailed guidance for applicants. Government will work with industry during the consultation period, including through the CfD Expert Group and other relevant groups such as the Offshore Wind Industry Council. The Department may also draw from the criteria provided in the FID enabling for Renewables process.
144. The areas that we currently expect to be addressed in the supply chain plan are:
 - a. Whether a workforce with the necessary skills to undertake the project is in place and, if not, whether the generator is confident the workforce can be secured. This will allow for consideration of the deliverability of the project and whether it is likely to lead to low carbon generation.
 - b. How the workforce skills will be maintained for the life of the project, or, as the case may be, developed and maintained. This will allow for consideration of how the project will contribute to the development of skills in low carbon generation and development.
 - c. Whether the proposed project is using a competitive procurement process so that technically competent and cost-efficient suppliers,

⁶⁷ External reports supporting this case <http://www.carbontrust.com/media/42162/ctc743-offshore-wind-power.pdf> and <http://www.thecrownestate.co.uk/media/305094/Offshore%20wind%20cost%20reduction%20pathways%20study.pdf>

regardless of their location, are able to compete for such contracts. This will allow us to assess whether the proposed project is likely to lead to a reduction in the cost of generating electricity from the chosen generation type. Numerous studies have demonstrated how increased competition in the low carbon supply chain could drive down the future cost of low carbon technologies; therefore Government is keen to improve the contestability of the low carbon supply chain. Actions of this type can help to ensure that the project is delivered in a sustainable and cost-efficient manner.

- d. Whether approaches have been taken or will be taken to implement a project in an innovative manner, including through research and development and technological development. Actions of this type may enable project costs to be reduced and support reductions in future projects' Strike Prices.

145. We intend to develop criteria which can account for the fact that applicants may be at different stages of their project and procurement design. We are mindful of the need to take account of the maturity of projects so that projects which may have made large financial investments in their supply chain or made contractual commitments before entering the CfD allocation system will not be disadvantaged. Applicants will also have the opportunity to provide supporting information such as third party verification by annexing this to the supply chain plan submitted. The Secretary of State's decision on whether or not to approve a supply chain plan will depend on whether the plan meets the criteria set out in the regulations and demonstrates sufficient actions have been or will be undertaken. The Government may also publish all submitted plans or any other supporting information that might help spread good practice, subject to addressing issues associated with commercial confidentiality. Any regulations made by the Government concerning supply chain plans will be underpinned by supporting guidance for applicants to consider when seeking the Government's approval of a plan.
146. Once this guidance has been finalised (following the consultation planned for this November), Government will only make changes to the guidance, following an adequate period of consultation with the affected parties, and will provide sufficient notice to allow generators who may be planning to apply for a CfD in future to enable them to take these changes into account before submitting their plans. Should the Government wish to change the criteria set out in the regulations, revised regulations will be required which will be subject to consultation.
147. Our working proposal is that Government will have a maximum of 90 days to approve or reject a plan, although it is unlikely that the full time will be required. We would aim to process all applications within 30 days assuming all information is received up front. If applications were incomplete and further

information was requested then this could further extend the timetable. Once a plan has been approved, we anticipate that this approval would be valid for 12 months.

148. After the project has been built, Government may request a post-build report and may publish the report, removing any material deemed commercially sensitive. The intention of the post build report is to provide the Government with information about how and to what extent the supply chain plan has been implemented - noting that the generator may have altered the approach to that set out in the supply chain for good reason during the build, and this may be clearly explained in the post build report. If generators do not submit a post build report when requested, consideration will have to be given to making this a legal requirement.

3.2.2.5 CfD Allocation

149. The allocation of generic Contracts for Difference under the administrative strike price-setting phase of CfDs has been designed to balance the need to ensure timely access to the scheme, with the requirement to make efficient use of the available budget. As set out in Figure 3.5 below, the allocation design under administrative price-setting is made up of three key stages:
- First Come First Served (FCFS),
 - Unconstrained Allocation rounds; and
 - Constrained Allocation Rounds.
150. Government intends to move to competitive price discovery processes for all low-carbon technologies as soon as practicable. We envisage the competitive price discovery processes will build on the design of auctions under constrained allocation rounds.
151. The duration of the First Come First Served phase of allocation will be impacted by wider decisions on the use of the LCF cap including decisions relating to Investment Contracts, and the Renewables Obligation calculation and wider value for money and affordability considerations. There are some scenarios in which FCFS may only last for a short period or may not be able to operate at all, and, if so, Government will consider moving immediately to allocation rounds and will also consider introducing constraints for certain technologies or groups of technologies.

Figure 3.5: The stages of CfD Allocation

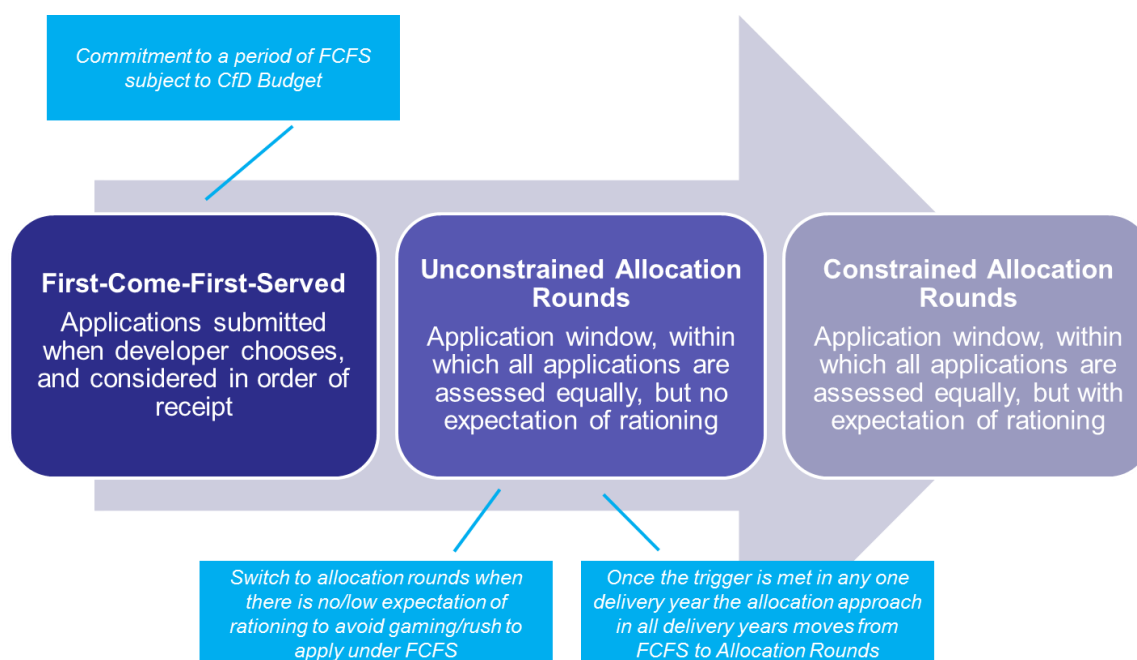

First Come First Served

152. The rationale for beginning allocation through the First Come First Served (FCFS) process is to allow eligible projects to benefit from the scheme without undue delay or uncertainty. The First Come, First Served process is designed to be as mechanical and simple as possible. This first stage was developed in response to industry concerns about unnecessarily constraining the process of allocation, which could impact on the timing of investment decisions. However, we acknowledge that the introduction of FCFS raises the risk of gaming and a rush to avoid constrained allocation.
153. Once an application is submitted the EMR delivery body will check that the Generator satisfies the eligibility criteria and that there are sufficient funds available in the remaining CfD budget. If this is the case the EMR delivery body will notify the counterparty of the name of the eligible generator, along with other specified information needed to issue the CfD.
154. Applications under FCFS will be awarded in order of application date. If maxima are used, then if the maximum defined for any technology or group of technologies is reached, no more allocation would be possible to that technology/ group for that delivery year. However Government retains discretion to increase the maximum. Minima or protections for technologies will have no effect at this point unless they have the effect of activating the trigger (which will be a significant part, perhaps 50% of the CfD budget) for contacting the Secretary of State to ascertain whether FCFS should be stopped and allocation rounds should commence.

155. In the event that no determination of eligibility is made by the EMR delivery body, it will notify the applicant of this and the reason for not meeting the eligibility criteria. Under FCFS, the project is free to re-apply if eligibility is rejected, although the project will not retain its place in the queue of projects while it seeks to remedy deficiencies in its application. If instead the project appeals the decision, the corresponding level of budget will be reserved during the appeals process, but should the appeal fail the budget is released and the applicant will need to re-apply at that point.

Allocation Rounds

156. The intention is that once a trigger has been met (for example if a significant part, perhaps 50%) of the CfD budget within any delivery year has been used up, the EMR delivery body will seek Government's approval to move to Allocation Rounds⁶⁸ The precise level for this trigger is set will be confirmed in the final delivery plan, planned for publication in December 2013.
157. Once Allocation Rounds have been introduced, they will operate for all delivery years and across all technologies. First Come First Served will cease regardless of whether other delivery years have yet reached the trigger.
158. Allocation rounds will only allow applications to be submitted within a given date range. Once the deadline for the Round closes, eligibility for each applicant will be checked by the EMR delivery body and determinations of eligibility will be made. Then the total budget being bid for in that Round by eligible applicants will be calculated by the EMR delivery body.
159. Our intention is to increase the degree of budgetary control over time as CfDs are issued, to make best use of the available budget. In order to facilitate an orderly transition between phases, our preference is that Allocation Rounds start when there is a strong expectation that there will initially be no constraint, although this will depend on wider considerations as set out above.

Unconstrained Allocation

160. Once allocation rounds have been introduced, unconstrained allocation is expected to follow FCFS in order to ensure an orderly grouping of applications so that the CfD allocation Budget can be effectively monitored and managed.
161. Unconstrained allocation is preferred (where wider considerations allow) in addition to FCFS in order to ensure an orderly transition to competition.

⁶⁸ Our current proposal is that Government will retain discretion to increase budget during FCFS. Should this ability be exercised, the more from FCFS could be deferred until the trigger is again reached.

162. If all the bids within the round can be satisfied within the currently unallocated budget for a given delivery year (unconstrained) then all projects are allocated contracts. The exceptions to this may be where a technology or group of technologies minima or maxima interact with the wider budget in particular ways.

Constrained Allocation

163. The rules for constrained allocation will be set out within the Allocation Technical Framework. If there is insufficient budget to satisfy all bids or maximum constraints are exceeded, then an auction (constrained allocation) will apply. The mechanics are still being developed, but the following summarises our proposals in the Allocation Methodology published in August. These are subject to further development through our engagement with stakeholders:
- Firstly, if there are any technologies with a protected budget (minimum), then any eligible projects within these technologies will be added together. If the value of the eligible projects adds up to less than the protected budget for that technology, we currently propose they will all be allocated contracts at the administered Strike Price. If not, then an auction is run for that technology. The successful bidders will be allocated contracts. Those that are unsuccessful then move into the general auction.
 - Second, an auction is run involving all remaining eligible applicants and all technologies. These are ranked by strike price (whether their default strike price or a lower bid price if they submitted one).
 - Starting with the cheapest bid, each eligible project will be awarded a contract until either (i) any maximum budgets for given technologies /groups are reached (in which case all remaining applicants in that category are rejected) or (ii) the budget for that delivery year is used up, at which point any remaining applicants are rejected.
164. Our preference is that the constrained allocation process will operate on a “pay-as-clear” basis for each technology or technology group, although Government is considering alternative auction formats, such as pay as bid. The Strike Price paid to any generators with a CfD will in any case be no higher than the administrative strike price for the technology.

3.2.2.6 Tie-Breaker Rules

165. The allocation methodology published in August set out our approach to handling a scenario within the constrained allocation process in which it is not possible to distinguish between two projects on price alone (termed ‘tie breaker rules’).

166. Firstly preference will be given to the combination of projects that makes best use of the available budget. If this fails to provide a clear allocation of projects, the next rule will be to give preference to those projects submitting their application earliest.

3.2.2.7 Phased Projects

167. We also published details of our preferred approach to the treatment of phased offshore wind projects which commission their capacity over a number of years in the August Allocation methodology publication. We propose to allow each phase of a multi-year project to receive the strike price available for the delivery year of the first phase. The CfD contract management process will also ensure that projects wishing to deliver in phases can be held to account against appropriately tailored Substantial Financial Commitment Milestones, Target Commissioning Dates, Longstop Dates and Termination Provisions. In addition, there will be a requirement that the target commissioning date for the final phase of a project must be the earlier of the two following points:

- two years after the target commissioning date of the first phase; and
- 31 March 2021.

168. The Government has indicated that, as with the Renewables Obligation, the CfD allocation process will ensure that offshore wind projects which need to deliver in up to three phases and which meet the specified conditions will be able to secure support. As part of its work to refine arrangements for phased projects the Government will continue to involve the CfD Expert Group, as well as employing targeted engagement with relevant offshore wind generators and appropriate renewable trade associations.

3.2.2.8 Appeals provisions

169. Regulations will provide generators with a process for appealing EMR delivery body decisions on their eligibility for a CfD, where they feel they have reason to believe that the EMR delivery body incorrectly applied the rules. First, the EMR delivery body will check and review their decision at the request of the unsuccessful applicant. Second, if the applicant still believes that there is an error, they will be able to appeal to Ofgem to check the EMR delivery body's decision. The timing for the appeals process will be built into the allocation timetable so that no further allocation of CfDs will be built into the allocation timetable so that no further allocation of CfDs will be made until any outstanding appeals are satisfied; thereby protecting applicant's whilst they are going through this process. While the Secondary legislation will place an obligation on the EMR delivery body to provide the first tier appeals route set out above, we intend to discuss with Ofgem further the issue of moving to an

appeal to Ofgem should the EMR delivery body fails to confirm its first tier decision within the relevant timescales.

170. CfD budget will be reserved by the EMR delivery body for appellants, pending the EMR delivery body's or Ofgem's (where the appeal reaches the tier 2 stage) determination of the relevant dispute. This will apply whether allocation is at the First Come First serve stage or in allocation rounds (constrained or unconstrained).
171. Our current intention is that the appellant would have a right of appeal to the High Court provided for within secondary legislation in the event it wishes to dispute Ofgem's decision.
172. We are also currently considering how we can most effectively provide for checks on the EMR delivery body's calculations in three key scenarios:
 - (1) moving from FCFS to allocation rounds,
 - (2) moving from unconstrained to constrained allocation; and
 - (3) the ranking of applicants and setting of strike prices where there is allocation under constraint.
173. We are considering the possibility of requiring under the allocation regulations for an independent audit to be conducted in respect of the calculations referred to above on every occasion upon which such calculations are made, to give all parties confidence that these calculations have been processed correctly by the EMR delivery body.
174. This independent audit would be designed to provide a reliable and thorough independent check of the relevant calculations; we are currently considering who would be the most appropriate body to conduct such an audit.
175. However, if we are not satisfied the requirement for an independent audit as set out above sufficiently mitigates against the risk of miscalculation and affords appropriate protection to applicants, the alternative would be to provide for an appeals process similar to that provided for eligibility.

3.2.2.9 Allocation Process in Legislation

176. The CfD Allocation Regulations and accompanying Allocation technical Framework provided for under Chapter 2 Clause 10 of the Energy Bill will set out the enabling framework for the allocation process. We are still considering the exact split between the regulations and ATF but the framework would be expected to include:

- the types of allocation – that there will be provision for a first come first served process, that there will be allocation rounds and how these will be carried out.
- the role of the EMR delivery body in operating allocation, and the regulatory duty on Ofgem and the principles Ofgem will use when assessing the EMR delivery body’s performance.
- That when an allocation round reaches a budget limit an objective methodology for constraining the value of contracts will be applied on the basis of price.
- That changes to the allocation under constraint methodology must be set out in the Allocation Technical Framework; and that there must be tiebreaker rules set out in the Allocation Technical Framework.
- That the way technologies with minima and maxima, and phased projects are treated in constrained allocation round will follow detailed rules set out in the Allocation Technical Framework.
- The appeals and dispute resolution processes available to generators at both the stage that eligibility is assessed and when allocation has taken place.
- That the Government must set out the conditions when they would expect to move from FCFS to constrained allocation in the Allocation Technical Framework; and the process the EMR delivery body will follow when the trigger points between round are met.
- That the trigger values for moving between rounds may be amended subject to set notice periods to be communicated to industry.
- That once a trigger has been activated the change to allocation rounds applies for all delivery years in that allocation round and all subsequent allocation rounds.
- Regulations will also set out that should the Government wish to delay the move from FCFS or the use of constraint mechanics, if more budgetary risk is acceptable, or there has been a change in the LCF, he/she can allow the EMR delivery body to allocate CfDs.

Most relevant sections of the draft instruments that relate to this section

The Contracts for Difference (Allocation) Regulations 2014.

Allocation Process

Question CFD7

- Do you agree that the proposed split between regulations and the CfD Allocation Technical Framework is the best way to implement the policy, whilst retaining the necessary flexibility?

Question CFD8

- Do you have any further comments on any aspects of the design of the allocation process set out in this section (you may wish to refer back to the detail of the allocation process set out in the August Allocation Methodology)?

3.2.3 Phase 2: From Contract Signature to Commissioning

Figure 3.6

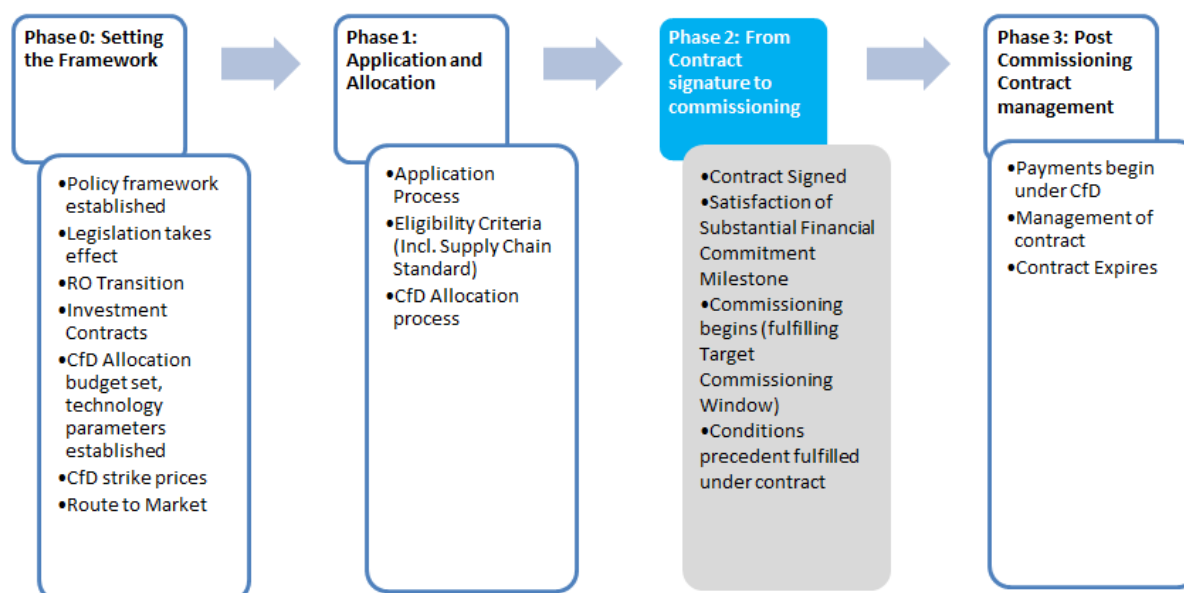

Summary:

- In **Phase 2**, the generator and the counterparty will sign a contract to provide payment according to the strike prices.
- The CfD contract will include details of when the generator must begin commissioning (Target Commissioning Window), and other clauses designed to incentivise timely delivery of generation and protect the scheme against under delivery by participants.
- There will be limited scope to vary the contract pre-signature, in cases where the generator requests minor and necessary modification to the standard terms of the contract.
- The counterparty will be a party to the contract with the Generator and will perform the obligations set out in the CfD Contract.
- Projects that have secured a CfD will be monitored and face incentives under the contract to deliver in a timely fashion.
- We propose to include in the contract the right to two 'cost-free' capacity adjustments in addition to other flexibility.

3.2.3.1 Contract mechanics

177. The CfD regime will operate through a contract between the counterparty and each relevant generator. This contract will set out the terms of the CfD arrangements associated with that relevant generator. We published draft contract terms in August 2013, and expect to publish updated contract terms as part of the Investment Contracts in December 2013, and will also consider whether a further update of contract terms is required to support the Parliamentary process in the first half of 2014. Once Royal Assent is received and the regulations take effect, the CfD contract terms for the first allocation by National Grid will be confirmed.
178. However, it is expected that each CfD may need to cross-refer to other documentation which is relevant to the implementation of the contractual terms, for example, relevant industry codes or documents that might need to be referenced (such as particular fuel measurement arrangements). Additionally each CfD that is signed will require a series of automatic, project-specific variations before it is signed including, for example, to take account of the type of facility, Target Commissioning Date and Target Commissioning Window (details of these terms are set out below).
179. This would mean that the single form CfD would necessarily have to contain the drafting for both baseload and intermittent generation plant with the relevant option being selected when the contract is entered into.
180. From the CfD Counterparty's and possibly the generator's perspective we believe that this would be likely to result in the CfD being unwieldy in length given that the CfD variations for a particular technology type could be extensive and will not be confined to a single clause within the CfD. Further, for any given project, care will need to be taken to ensure that the required CfD variations are correctly captured throughout the document. This could be an extremely time-consuming exercise both for the CfD Counterparty and the generator, carrying a significant risk that unintentional errors are made in the finalisation of each CfD.
181. We have considered two options to enable the CfD contract to incorporate these potential variations and cross references to other documents:

- **Option 1: Multiple pro forma CfDs**

One option would be for multiple standard form CfDs to be produced (for example one for each major technology type and then for baseload and intermittent generation). This would eliminate the need for certain tailoring of the CfD to be undertaken manually and, as such, is likely to reduce the risk of unintentional errors being made.

However we believe that such an approach will be impracticable to implement because in all likelihood it would require the development of a significant number of “standard form” CfDs, creating difficulty in ensuring that there is consistency between contracts. Nor would it obviate the need for manual amendments to be made to effect the CfD variations.

- **Option 2: Cover sheet coupled with standard CfD terms and conditions**

Given the practical and substantive issues associated with option 1, our preferred option is to pursue a contractual structure which provides for each generator to sign a cover sheet which incorporates by reference a standard set of CfD terms and conditions.

182. Option 2 provides certain advantages over option 1 because:

- The Standard Terms would apply to all CfDs, irrespective of the nature of the project;
- The cover sheet and standard terms structure will allow for greater flexibility for Government and generators in the early years of the CfD regime when terms are likely to need a period of bedding down;
- The cover sheet and standard terms structure would document all of the required CfD variations in a streamlined manner. In particular, we are expecting that the CfD application and allocation process will provide for a checklist of required information in relation to each project (for example, this would include a requirement for the generator to propose a target commissioning date, the target commissioning window and the substantial financial commitment, and to meet certain eligibility criteria each within defined parameters).

183. Under option 1, it is likely that such matters would need to be dealt with by locating the relevant definitions or operative provisions within the CfD and amending the drafting (manually) to reflect the desired CfD variation, including through the removal of redundant provisions. Under option 2 it would be possible for the information in the CfD application to be used to pre-populate the cover sheet and standard terms structure with the desired CfD variations.

184. The approach described in option 2 will facilitate more effective contract management by the Counterparty. For example we envisage that it would allow for a database of key variable terms across all projects which benefit from CfDs to be populated by reference to the checklist items contained within the cover sheet and standard terms structure rather than a more labour-intensive review of the entirety of a CfD (which would be required under option 1). In this context, the project-specific CfD variations will be listed in the cover sheet but fully detailed within the standard terms.

185. We envisage that the cover sheet will list the project specific details (referred to as 'identifiers'), including:
- Generator name;
 - Project name;
 - Planned installed capacity (and if appropriate, the Renewable Qualifying Multiplier - the proportion of the generation which comes from a low-carbon source, which will apply to many biomass plants but could in future also apply to CCS projects, and which when multiplied by the planned installed capacity would give the 'green' installed capacity);
 - Location (map reference, and in the case of offshore wind projects requesting phasing, the Crown Estate lease area);
 - Target Commissioning Date (TCD) and start of Target Commissioning Window (TCW);
 - Technology (from a list of 'eligible technologies', to be defined in regulations), which dictate:
 - Strike price (in first come first served or unconstrained allocation),
 - Target Commissioning Window length,
 - Long stop date,
 - Whether the installation is baseload or intermittent;
 - Strike price (in a case of constrained allocation);
 - Any specific details that may be required relating to FMS (Fuel Measurement and Sampling) requirements (if the technology is advanced conversion technologies, dedicated biomass, biomass conversion, energy from waste, anaerobic digestion, landfill waste, sewage waste or CCS);
 - Connection type (i.e. transmission, distribution or private wire);
 - Potential modifications to the CfD standard terms (explained below).
186. There are likely to be changes in market conditions, resulting from developments in technologies, changes in market structures, or the integration of European electricity systems. As a result we are proposing that the Government will have the power to set out and revise the standard CfD terms, from time to time, to ensure that they remain the best possible form of support to deliver government objectives. The Government intends to table an amendment to the Energy Bill to enable this.
187. However we envisage that there should be controls in place in order to provide certainty to investors and developers as to the nature of possible future changes to any contract. In revising the standard terms the Government will be bound by a duty to consult. Regulations may set out the nature of the provisions that could be included in CfDs. However we envisage that the Government's revisions to the standard terms will not apply to

projects that have entered into a CfD allocation round before the revisions were made.

188. Additionally we also recognise that generators may request minor and necessary modifications to the standard terms before signing a CfD. We believe that the flexibility to allow for contract modifications to be proposed by generators is essential because the standard terms cannot foresee every potential generator's legal and financial circumstance, and therefore there are likely to be areas of the standard terms which will not be efficient for particular projects. One particular example is where the generator requests a change to the confidentiality clause to reflect specific disclosure requirements. To do this there will need to be an amendment to the Energy Bill, and we are seeking this subject to the will of Parliament.
189. However it is crucial that the flexibility to modify contracts is tightly defined so that it is not used by some generators to gain a commercial advantage over their competitors, nor to open the doors to negotiations between generators and the CfD Counterparty on every contract. This flexibility should be used solely to aid eligible generators that are denied access to a CfD for technical reasons which they cannot change.
190. In particular, we envisage that there will be two criteria that must both be met for modification to be approved by the Counterparty:
- d) The modification must be 'minor', meaning that it must not alter the risk-reward ratio at the heart of the CfD
 - e) The modification must be 'necessary', meaning that the generator must demonstrate that they cannot sign a CfD on the standard terms
191. Any modifications to the standard terms must be agreed with the Counterparty in advance of a generator applying for a CfD. We envisage the entire process taking an average of around 20 working days. However this would depend on the complexity of the modifications being requested.

3.2.3.2 Pre-commissioning Contract Management

192. Projects that have secured a CfD will be monitored and face incentives under the contract to deliver in a timely fashion.
193. All CfDs will include a Substantive Financial Commitment Milestone at a relatively early stage in project development that will help identify projects that are not progressing towards commissioning in a timely manner. CfDs that do not meet their Milestone will be terminated and the CfD budget reallocated to new generators.

194. Target Commissioning Windows and Long Stop Dates for each technology were published in draft form in the Allocation Methodology in August 2013 and allow for Government to manage the consequences of late delivery of capacity by generators. This will be done firstly through the commencement of the contract at the end of the Target Commissioning Window even if the level of capacity linked to the condition precedent to payments has not been achieved and then through the termination of the contract by the Long Stop Date if the level of capacity has still not been achieved.
195. Generators will be able to make reasonable adjustments to their projects and to amend the capacity of their development, once more detailed site analysis and procurement processes have taken place. We have set out a process that would allow for 2 periods of free adjustment and a further period of adjustment at some cost to the generator, followed by contract termination if the final adjusted amount of capacity is not achieved.

Substantial Financial Commitment Milestone

196. The first part of this system is the Substantial Financial Commitment Milestone (SFC), which will need to be met within one year of signature of the contract. Generators will provide the CfD Counterparty with evidence they have spent a (technology-specific) percentage of overall costs by the milestone date and/or that they have entered into other commitments that are a proxy for spending money such as signing contracts committing significant expenditure against the delivery of the agreed capacity by the Target Commissioning Date.

Target Commissioning Window

197. The second incentive is the use of a Target Commissioning Window (TCW). This window is the period of time within which a generator is able to commission (including achieving the Further Conditions Precedent (FCP) in the contract) without penalty. The length of the Target Commissioning Window aims to reflect the technical challenges faced by generators of each generation type.
198. *Force majeure* provisions within the CfD contract (Schedule 2) provide for circumstances which are outside the generator's control and which would result in a delay to commissioning within this window.
199. Failure to meet the "Further Conditions Precedent" in the contract results in the 15 year term of the CfD commencing even though the plant is not yet eligible to receive top-up payments through the contract. This has the effect of gradually reducing the effective period of support offered to a project.

Longstop Date

200. The third incentive is the Long Stop Date. The Long Stop Date is the point beyond the end of the Target Commissioning Window after which a project which has failed to meet its contractual “Further Conditions Precedent” will have its CfD terminated by the counterparty. This allows for the EMR delivery body to reallocate budget to new applicants.
201. This control ensures that the available budget for CfDs is not permanently tied up by projects which fail to commission.

3.2.3.3 Contract Capacity Adjustment

202. We propose to include in the contract the right to two ‘cost-free’ capacity adjustments: (i) flexibility that must be used or surrendered at the Substantial Financial Commitment Milestone and (ii) flexibility that is available at any point up to the Longstop Date. We currently propose allowing a 5% adjustment to be made at each of these stages.
203. These are in addition to other forms of flexibility, such as *force majeure* provisions in the contract (which allow for circumstances outside the generators control) and the ability to adjust capacity in response to certain geological conditions.
204. In addition to the two cost-free capacity adjustments, we also propose to allow the generator to deliver less than the adjusted level of capacity, although making use of this further flexibility will result in a reduction to the strike price. Government currently proposes that the cost of adjustment is 0.5% of the Strike Price for every 1% adjustment in capacity.
205. Contract Termination would only be a risk if the amount of capacity delivered by the Longstop Date falls below a minimum level which would be a Further Condition Precedent in the contract. We currently propose that this be set at circa 70% of the initially agreed capacity. It would be open to Generators to plan to use this flexibility at any time; so a Generator might choose at financial close to change its project in a way that reduced capacity delivered (in the knowledge that this will reduce the strike price).
206. More detail on events that might lead to contract termination is set out in the Further Conditions Precedent section of the Draft CfD Contract⁶⁹.

⁶⁹ Clause 3, and Schedule 1 of the Draft CfD Contract

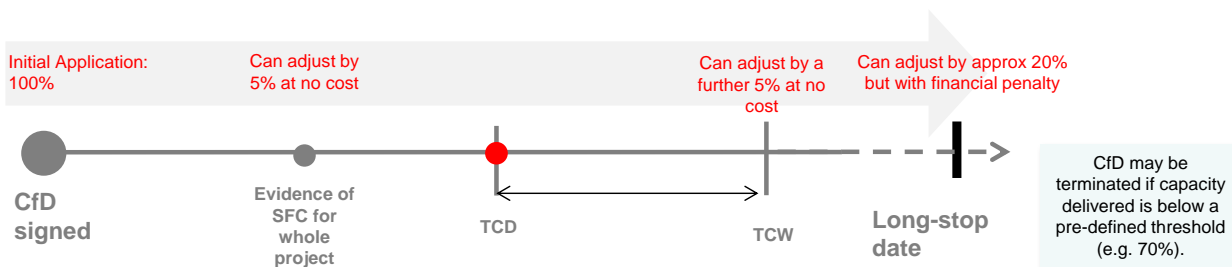

Contract Management	
Question CFD9	Do you have views on any aspect of the proposals set out in this section?

3.2.4 Phase 3: Post Commissioning Contract Management

Figure 3.7

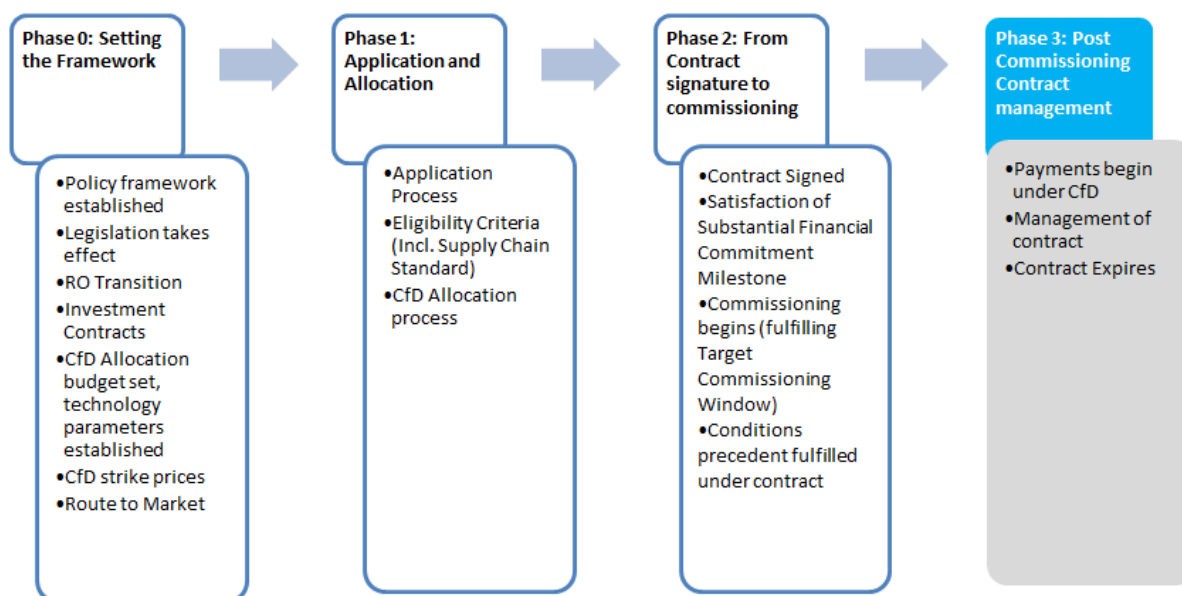

Summary:

- In **Phase 3**, payments will begin under the CfD until such a time that the contract with a particular generator expires (or is terminated for a reason as set out in Section 2.3 above).

- The counterparty will manage the contract for the duration of the life of the contract, including managing the process of termination if circumstances require it.

3.2.4.1 Post Commissioning Contract Management

207. Once new plant has been commissioned the counterparty will monitor the generator's performance under the contract to ensure that the generator is not in breach of the contract. It will also provide certain administrative functions such as ensuring the dispute resolution and change control processes are in place.
208. The counterparty will use information provided by the generator to allow the processing and settlement of payments: of a general nature (such as details of any material events or circumstances likely to affect the Project) and a specific nature (such as Metered Output forecasts and expected Facility availability). The counterparty will calculate the Intermittent Market Reference Price by reference to the EU Price Coupling Algorithm used in the day ahead EU market coupling arrangements. A Strike Price adjustment will be made once a year to adjust the Strike Price in line with movements in the Consumer Price Index and to take into account any adjustments arising through Qualifying Change in Law adjustments (see below). If the Reference price goes above the Strike Price the counterparty will collect generator payments and ensure the posting of appropriate collateral as set out under the contract.
209. The counterparty will also be responsible for risk-based monitoring of key areas including on-going eligibility criteria, metering obligations and termination circumstances. The technology at the generator's plant facility will be assessed as to continuing compliance with the eligible technology types and the facility's agreed capacity which, if found to be in breach, could lead to a formulaic reduction in the Strike Price. A failure to comply with metering obligations may lead to payment being suspended and could trigger a right for the counterparty to terminate the CfD for any extended and unresolved non-compliance.
210. Termination rights arise for the counterparty under a number of circumstances where the generator is in default, which will be monitored on an ongoing basis, specifically: insolvency, failing to pay amounts due, ceasing to be the legal owner of the relevant facility, breaching the rules under Clause 46 (Transfers) of the contract on when the generator may assign or otherwise transfer its rights, benefits or obligations under the CfD; fraud in relation to the CfD; any credit support required under the terms of the CfD (or the provider of any such credit support) not being in accordance with the terms of the CfD; or as a result of an extended and unresolved breach of its metering obligations

under Clause 17 (Metering). Should any such circumstance arise, the counterparty will decide whether to terminate the contract and whether compensation is due.

211. The counterparty will also manage any requests for 'Change in Law' amendments. This covers changes in law which both (1) were not foreseeable prior to the CfD being entered into, and (2) fall into one of the three defined terms "Discriminatory Change in Law", "Specific Change in Law", or "Other Change in Law". The two parties will follow the process as defined in the contract to agree whether such a qualifying change has occurred and any resulting costs or savings to the generator. The appropriate methodology will be applied by the counterparty to calculate any Qualifying Change in Law Compensation, which may result in a change to the strike price or a compensatory payment.

Section 3.3: Payment Model and Supplier obligation

Summary:

- This section sets out the payment model for payments to flow between generator, counterparty, and Suppliers, and the role of the settlement agent working on behalf of the counterparty. Further information on the counterparty and its constitution and governance can be found in Section 3.4.
- All licensed suppliers in Great Britain and Northern Ireland will be obliged to pay the supplier obligation – a compulsory levy – by virtue of the regulations which set out the terms of the supplier obligation. The supplier obligation will be enforceable as if it were a licence condition.
- Government will implement the supplier obligation in legislation. It will be expressed as a formula, as the exact amount cannot be known until all supply and generation data is finalised.
- To calculate how much is payable by suppliers the counterparty will forecast the total CfD costs for the year and set a unit cost fixed rate which will be a pound per megawatt hour rate (£/MWh).
- The counterparty will then reconcile payments received (at the unit cost fixed rate) against the actual levy due (based on the levy formula).
- Suppliers will be required to contribute to a reserve fund and insolvency reserve fund to ensure payments due under CfDs can always be paid.
- Suppliers will have at least 3 months' notice of the unit cost fixed rate and the sums needed for the reserve funds.
- Suppliers will be required to post 21 calendar days of collateral to cover upcoming payments.
- Suppliers will be invoiced on a daily basis, 8 business days after the billing period (the day for which the supplier obligation is due based on electricity supplied). They will have 5 business days to make the appropriate payment.
- If a supplier has not paid an invoice within 2 calendar days this will be registered with Ofgem. If the non-payment is not rectified then the counterparty will report this breach of licence to Ofgem within a further 5 calendar days.
- Generators will be paid 28 calendar days after the billing period.

212. The payments due to generators under CfDs will be calculated and paid out by the counterparty (utilising its settlement agent). The counterparty receives funds for the CfD payments from suppliers through the supplier obligation.
213. The following sections outline an approach to the supplier obligation which is designed to give generators the confidence that they need in order to bring forward investment, i.e. that they will be paid.
214. This is especially important given that the Contract for Difference sets out that the liability of the counterparty shall not exceed the amount from time to time received and held by the CfD Counterparty under the supplier obligation.
215. It could be argued that given the high level of confidence that can be had in payments flowing, such a provision is unnecessary. However, we believe it is important to the health of the regime to limit the risk of insolvency of the counterparty where possible.
216. The Energy Bill includes powers to make regulations to create the supplier obligation. These allow for regulations for the holding of collateral, the mutualisation of debts or holding sums in reserve (funds). The passage of the Energy Bill thus far has demonstrated the importance of the supplier obligation to generators and investors, and the Bill was strengthened during its passage in the House of Commons to include a number of duties that the Government and the counterparty must comply with.
217. Firstly, the Bill places a duty on the Government so that the Secretary of State must make provision for electricity suppliers to pay a CfD Counterparty for the purpose of paying CfDs. It is not an option to not have a supplier obligation. Secondly, the Government must include such provision as is necessary to ensure that a counterparty can meet its liabilities under any CfD to which it is a party. It is therefore not an option to create a supplier obligation which is only sufficient to pay some CfDs, but not all. Having strengthened the duties on the Government in the making of supplier obligation regulations, the Bill also places a new duty on the counterparty to exercise the functions that it has to ensure that it can meet its liabilities under any CfD to which it is a party. The Government also took the opportunity to clarify within the Bill that the counterparty can recover sums owed to it as a debt.
218. In line with the duties set out above, the supplier obligation regulations are designed to ensure that the Counterparty can meet its contractual obligations and provide certainty to generators that they will receive the amounts due to them under the CfDs. The regulations are also designed in way that is mindful of the impacts on suppliers and consumers.
219. The proposals within the current document include:

- The posting of 21 days of collateral on a rolling basis by suppliers. This has been reduced from the previous proposal of 50 days, bringing down costs to suppliers, but still providing credit to cover all amounts outstanding from billing to payment. By 2020, we estimate that the counterparty will be holding collateral between £190-£280 million.
 - Under the preferred option, the collection of a reserve fund sized to ensure that it is sufficient to smooth payments and manage any in-year variation (deviations from the forecast elements). This fund will increase over time, by 2020 reaching a potential £60-£290 million depending on the approach taken to sizing under different scenarios.
 - The ability to make payments to generators is further enhanced by paying generators 28 days in arrears, which provides the counterparty with immediate cash flow to absorb and manage initial late payments or fluctuations whilst backstops are triggered.
 - The collection of an insolvency reserve fund, to cover a conservative estimate of the maximum likely period between exhaustion of a suppliers' collateral, and the achievement of an enduring solution (the appointment of an Energy Company Supply Administrator, or Supplier of Last Resort) should a supplier be in distress. We have sized the fund on the basis of multiple small supplier default. Using a shared insolvency fund to cover this risk is cheaper than asking for individual collateral to be posted for longer. By 2020, we estimate that this fund could be from £19-£28 million.
 - The ability to mutualise amounts that are drawn down from the insolvency reserve fund, to maintain it at the required level.
 - These proposals are further supported by the ability of the counterparty to not only report any supplier default or non-payment to Ofgem to take further action but also pursue those defaulting suppliers through court to recover monies owed.
220. Holding money to cover risk creates costs for both the counterparty (via the reserve fund) and suppliers (via the risk premium), and we have been mindful of this in our proposals to size the funds. The impact assessment that accompanies this document sets out the potential impact on suppliers and consumer bills of financing these risk management tools⁷⁰, estimating the annual average consumer bill impact at between 27p and 54p annually for the period 2016-2020.
221. Ultimately, should the above proposals prove insufficient, such that the counterparty lacks the sufficient funds to cover payment due, it has the ability

⁷⁰ Based on an industry-weighted average cost of finance of 6.744% (for further detail, see the accompanying Impact Assessment)

to adjust the unit cost fixed rate or seek additional funds from suppliers. This may cause concern for some suppliers, who will be keen for maximum certainty that a fixed charge will apply throughout the year. However, we believe that given the conservative approach to sizing the funds, the likelihood of requiring such a change is low.

3.3.1 Start of the supplier obligation

222. Initial discussions with potential generators and consideration of the systems changes that will need to be put in place by both suppliers (for payment of the supplier obligation) and the counterparty and Settlement agent suggest that payments may flow to generators from April 2015. However, this remains under discussion. Under our proposals, suppliers will have at least 3 months' notice of the supplier obligation rate for any levy year, including the first year.
223. We envisage that the first payments under the CfD for generators in Northern Ireland will flow from 2016 at the earliest, at which point the supplier obligation will be levied on Northern Ireland electricity suppliers.
224. The Government has previously stated its intention to exempt Energy Intensive Industries (EII) from some of the costs associated with Contracts for Difference, subject to State Aid approval. This exemption will be implemented through the supplier obligation by excluding any exempt electricity supplied from the levy calculation when looking at the relevant suppliers' market share. More detail is set out at section 2.4.14 below.

3.3.2 Type of levy

225. In November 2012 the Government announced that it was minded to implement a variable rate levy, where payments in from suppliers in each period exactly matched what was to be paid out to generators. In response to the call for evidence on the supplier obligation⁷¹ many suppliers expressed strong concerns about the impact of managing payments under a variable rate levy. The Government has taken these views into consideration and undertaken further analysis of the levy impacts.
226. In light of this, the Government set out a revised position in its response to the call for evidence, published in August 2013.⁷² It set out a preference for a unit cost fixed rate levy, where the counterparty will forecast the total CfD costs for the year and set a pounds per MWh rate against which suppliers are charged according to their actual supply in any billing period. Suppliers will also be

⁷¹ https://www.gov.uk/government/uploads/system/uploads/attachment_data/file/65635/7077-electricity-market-reform-annex-a.pdf

⁷² <https://www.gov.uk/government/consultations/contracts-for-difference-cfd-supplier-obligation-call-for-evidence>

required to contribute to a reserve fund – to cover mismatches between payments in from suppliers and payments out to generators in any given period to allow payments to flow in more extreme scenarios than were predicted when the rate was set and allow for a margin of error in forecasting.

227. The preference for a unit cost fixed rate payment was a result of independent analysis of the call for evidence responses, further work on the potential volatility of CfD payments and analysis of alternative types of levy. This analysis has now been updated and is set out in an impact assessment that accompanies this publication. The Government's preference remains for a unit fixed cost levy and this section summarises our consideration of the options, with relevant updates from the impact assessment.
228. The four types of levy being considered for implementation were:
- **Variable levy** – where all charges are based on metered data for generation output, strike price, reference price and supply data in any given period. Payments in from suppliers should always meet payments out to generators in each period. However, amounts owed will vary for every billing period and suppliers manage all of the risks associated with CfD payments i.e. they have to pay the counterparty exactly what is owed, and therefore have to individually forecast the right amount and collect it from customers.
 - **Generation fixed** – where the generation output is forecast and the strike price is known by the counterparty but the supply data is based on metered data and the reference price is based on actual wholesale price for the billing day (so suppliers would need to manage the latter two). In order to collect payments the counterparty would inform suppliers of the strike price and estimated generation volume for each contract in advance of the billing period. Suppliers would then be charged the difference between the stated strike price and the reference price (based on actual wholesale prices) for the specified volume generated (as estimated by the counterparty) in that billing period.
 - **Unit cost fixed** – similar to generation fixed but the counterparty also forecasts and fixes the expected reference price in advance. Supply data is still based on metered data. This would lead to a pound per MWh rate for suppliers. Monies would then be collected from each supplier based on the counterparty's set pound per MWh rate and the actual amount supplied in a given period.
 - **Fully fixed** – where all of the elements are forecast in advance by the counterparty and suppliers pay a set amount throughout the year. The counterparty would estimate the total amount to be collected over the year and allocate a proportion to each supplier in line with their market

share and then collect those payments at specified times throughout the year.

229. When making the decision on which type of levy to implement we applied the following principles:
- The levy should as far as possible not provide a competitive advantage to one group of suppliers over another;
 - The design of the levy should minimise cost to consumers;
 - Risks should be allocated where they can best be managed where possible;
 - The levy should not create additional barriers to entry or increase the likelihood of suppliers leaving the market; and
 - The levy should not have a negative impact on market liquidity (power trading).
230. With these principles in mind, and taking into account the Impact Assessment accompanying this consultation, the Government continues to believe that a unit cost fixed rate would provide an appropriate balance between market impacts, costs to consumers and allocation of risks. It would achieve this by reducing volatility in terms of suppliers' cashflows which in turn would lead to a lower risk of supplier default. It also places large and small suppliers on the most equal footing because it removes the need for complex hedging – which small suppliers are less able to manage. Risk managed centrally by the counterparty rather than each individual supplier is also more efficient.
231. The supplier obligation impact assessment shows that the annual average bill impacts of the various options, over the period 2016-2020, are £0.56-£0.89 for the unit cost fixed-rate option, compared to £0.68-£1.05 for a variable rate, £0.67-£1.03 for generation fixed and £0.56-£0.87 for fully fixed. This includes the cost of financing the reserve fund, collateral and insolvency reserve fund⁷³, as well as the costs of suppliers applying a risk premium under the more variable options.
232. We have also considered the impacts of the levy options on wholesale market liquidity. Our initial view is that a shift to a unit cost fixed rate levy would not change suppliers' incentives to achieve the reference price and therefore trade in the reference market. However, we understand that the electricity market is very complex and would welcome any further views from stakeholders on the impact that the type of levy, compared to other options, could have on the wholesale market and liquidity.

⁷³ Based on an industry-weighted average cost of finance of 6.744% (for further detail, see the accompanying Impact Assessment)

233. The Government also believes that a unit cost fixed rate is the most transparent approach to the levy. The counterparty will set one rate for the recovery of costs of CfDs, which will be published and known, rather than each supplier setting their own recovery rate. Under a unit cost rate the volatility of payments is managed by the counterparty through the reserve fund, this removes the necessity for suppliers to add a risk premium to tariffs, (which would be required under the more variable options) which could lead to overcharging of customers and an increase in supplier profits.
234. Further comparison of each levy option is provided in the accompanying supplier obligation impact assessment.

3.3.3 The levy formula and unit cost fixed rate payment

235. The CfD levy will be set in legislation with a formula, as the exact amount owed cannot be known until all generation and supply data is finalised at least 14 months after the end of the levy year. Prior to that, to calculate how much is payable by suppliers, the counterparty will forecast the total CfD costs for the and set a unit cost fixed rate (£/MWh).
236. When final data on CfD payments, generation and supply has been received, the Counterparty will use the formula in legislation to reconcile payments, i.e. establish the actual amount due, and make any refunds through credit notes, or additional calls for money as required, in light of payments made according to the unit cost fixed rate. The actual amount due will be exactly equal to the total CfD costs for the levy year. The formula to calculate what each supplier owes under the actual levy rate is as follows:

$$CF \times \frac{(SE - SX)}{(TE - TX)}$$

Where—

CF is the net CfD funding requirement;

SE is the amount of electricity supplied by that supplier in that supplier obligation period;

SX is the amount of excluded electricity supplied by that supplier in that period;

TE is the amount of electricity supplied by all electricity suppliers in that period;

TX is the amount of excluded electricity supplied by all electricity suppliers in that period.

237. The counterparty will set the unit cost fixed rate by using a model described in legislation, which will be developed and provided by Government. This payment will be based on total projected CfD payments for the year. The legislation will set out some of the key inputs used in the forecasting model to

- calculate total CfD payments. This will include the relevant data in each CfD contract such as strike price, generation output, and reference price and estimated supply (demand) data. The counterparty will have some flexibility to include other appropriate inputs to ensure the model is as accurate as possible and industry will be given the opportunity to input to the yearly forecasting process.
238. The counterparty will share its methodology and forecast data (where not commercially sensitive) with suppliers and generators at the time the rate is announced. The counterparty will update its model assumptions throughout the year as new data becomes available including actual CfD payment and supply data. The counterparty will provide reports on such updating at least once every quarter.
239. The counterparty will notify suppliers of the unit fixed payment rate, £/MWh, for the following levy year, no less than three months before the first payment is invoiced for that year. The levy year will run from April to March. Suppliers will be billed in line with the metered supply data (MWh) for each billing period. All payments will be calculated⁷⁴ using a mix of profiled and actual metered data (supplemented by estimated metered data where actual data is unavailable) in each case as calculated according to the Balancing and Settlement Code (BSC). This will be subject to reconciliation runs, again in accordance with the BSC.
240. Payments by suppliers will be due on each business day and will be based on metered volume within a day long billing period (the time over which supplier obligation charges are aggregated). Suppliers will have five business days, from the date the invoice is received, to make this payment.
241. When payment flows are reversed and the reference price is higher than the strike price generators will make payments to the counterparty. The timings for invoicing and making these payments will be the same as those set out for suppliers.
242. The counterparty will pay generators what is owed under their CfD contract 28 days after the relevant billing period. This will allow the counterparty some flexibility to manage its cash flow but still gives generators a certain date by which payment will be received.
243. The counterparty will have the ability to adjust the unit fixed rate or ask for additional funds in-year if it determines, through its monitoring procedures, that the reserve fund will be depleted to such an extent that it will not have sufficient funds to make future CfD payments. Given the conservative

⁷⁴ Except for generation and supply based in Northern Ireland, or for generators connected to private wires.

approach to sizing the reserve fund (outlined below) the likelihood of this occurring is very remote. It is also very unlikely that a supplier default could have an impact on the reserve fund as default is dealt with through the separate backstop mechanisms of collateral, a separate insolvency reserve fund and the counterparty's ability to mutualise payments across other suppliers. This should ensure that the correct payments are collected from suppliers and no shortfall is experienced by the counterparty.

244. Should the counterparty need to make any in-year changes, these will be determined by the updating of its model and shall be made to the unit fixed rate or reserve fund requirement as necessary for the counterparty to ensure that it is able to meet its statutory obligations to have sufficient funds to make payments under CfDs. Suppliers would be given 30 days' notice of any in-year adjustments. The proposed approach to in-year adjustments is not currently reflected in the draft regulations but will be included in the final version of the regulations.

Most relevant sections of the draft instruments that relate to this section

Regulations 3-11 in The Contracts for Difference (Supplier obligation) Regulations

The levy formula

Question CFD10	Do you have any comments on the proposed formula to calculate the supplier obligation?
-----------------------	--

Fixed Rate Levy

Question CFD11	Do you have any comments on what would be an appropriate minimum notification of the unit cost rate, bearing in mind that notification earlier than three months will be less accurate?
Question CFD12	Are there any other items of information that suppliers need in order to manage CfD payments?
Question CFD13	What are your views on the impact of a unit cost fixed rate levy on the incentives for suppliers to trade in the reference market and consequently wholesale market liquidity?

3.3.4 Levy Reconciliation

245. A unit cost fixed rate (£/MWh) will be set for the levy year in question before the start of that year. During the year payments will be made by suppliers based on their supply for each billing period, according to preliminary data from the BSC. Following this the counterparty will, as data becomes more accurate, reconcile and update the following:
- The amount individual suppliers should have paid at the unit fixed rate based on more accurate supply data as it becomes available for each billing period. Any amounts that are owed or need to be reimbursed because of changes in supply data in a current levy year will be charged or refunded at that year's unit fixed rate (£/MWh) through adjustments to current invoices. Payments or refunds due as a result of this reconciliation relating to previous years (noting that data are finalised over 14 and sometimes 28 months) will be noted as a credit or debit from or to the individual supplier's reserve balance;
 - Payments to generators based on updated generation data (MWh) from the BSC. This will affect the overall levy that was due from suppliers for that day and any differences will be either collected or reimbursed through their reserve accounts. The unit cost fixed rate that suppliers are paying will not be affected.
246. Supplier obligation and CfD payments to generators will be subject to data reconciliations following BSC data reconciliation runs⁷⁵ (and for certain generators, the provision of more accurate private wire generation data or updated information on their Renewable Qualifying Multiplier). We will reconcile supplier obligation payments for each individual Settlement Day when the BSC updates supply data following the Initial Settlement (SF) Run⁷⁶ and the following reconciliation runs up until the fourteenth month⁷⁷. Reconciliation for a levy year will continue until the data are finalised.

⁷⁵ Under the BSC, initial settlement is heavily reliant on estimates, particularly for suppliers with a large number of non-half hourly meters. The BSC gradually reconciles these initial estimations against actual data as provided by meter readings following a 14 month timetable. After 14 months (or on occasion 28 months where the BSC has carried out a Post Final Settlement Run following a dispute), the supply data for a particular Settlement Day is considered to be final.

⁷⁶ The SF run data is metered data available sixteen working days after the Settlement Day

⁷⁷ It is our intention that where a BSC Trading Dispute results in a Post-Final Volume Allocation Run after 14 months (this can occur up to 28 months later), that this reconciliation will also be applied to the supplier obligation. However, this is not currently reflected in the draft regulations that accompany this consultation.

247. Where these reconciliation runs take place during the same levy year as the billing period to which they refer, the Settlement agent will calculate whether an individual supplier owes an additional payment in respect of the billing period being reconciled and will inform the supplier in the next available supplier obligation invoice.
248. Where these reconciliation runs take place after the end of a levy year any payment adjustments will be made through suppliers' reserve fund balance. These amounts will then be incorporated in the reserve fund reconciliation process at the end of the year. Suppliers will be notified on a quarterly basis of the amount of prior years' levy payments and their reserve fund balance.
249. When the final data is received the counterparty will determine the actual supplier obligation rate for the year in question through the formula set out in regulations. They will then notify suppliers of the actual rate and total amounts paid.

Most relevant sections of the draft secondary legislation that relates to this section

Regulations 4, 5, 9, and 10 in The Contracts for Difference (Supplier Obligation) Regulations

Reconciliation	
Question CFD14	Do you agree with the described approach to levy reconciliation? If not, why and what alternatives can you suggest?
Question CFD15	Do you have any comments on how frequently the levy should be reconciled?

3.3.5 Reserve Fund

250. The introduction of a unit cost fixed rate payment from suppliers will mean that payments received by the counterparty for each billing period will not exactly match its payments out to generators. In order to ensure that the counterparty has sufficient funds to make CfD payments it will need to establish a **reserve fund**. The reserve fund is a way of managing the unpredictability, volatility and cash flow timing mismatches that will arise

within the counterparty's payment framework. The reserve fund is not designed to protect the counterparty from non-payment by suppliers.

251. Our proposal is that the reserve fund will be sized using a conservative approach to risk. The draft regulations set out that the unit cost fixed rate will be based on the estimated CfD payments for the year, taking account of expected CfD generation, electricity supply, reference prices and strike prices. The size of the reserve fund will be based on the forecast CfD payments under more extreme scenarios such as low reference prices and a high level of CfD generation. Using the forecast model the counterparty will determine what CfD payments would be under these more extreme scenarios and use this information to set the size of the reserve fund.
252. The current impact assessment reflects the potential size of the reserve fund under our preferred levy option as an average range for 2016 to 2020 of between £30-260 million. The minimum figure quoted is based on a 'high wind' scenario⁷⁸ and the maximum figure is based on a combination of this scenario with low fossil fuel prices⁷⁹. This analysis is based on modelling of two representative scenarios, to account for different types of volatility in CfD payments – prices (e.g. low fossil fuel prices) and generation (e.g. high wind volumes). The counterparty will have the flexibility to determine the most appropriate scenarios to consider when setting the size of the fund, which may also vary over time. The outputs of analysis based on these scenarios will then ensure that the counterparty has sufficient funds to make payments to generators.
253. The reserve fund will be sourced from suppliers as a lump sum cash payment at the start of each funding year. Other options to collect monies for the reserve fund were considered, including adding an incremental amount to the £/MWh payment. However, the Government was concerned that this could lead to a significant over collection of money from suppliers, and ultimately consumers. Such a gradual build-up of funds would also mean that should an unexpected event occur near the start of the levy year which resulted in an increase in generator CfD payments there would be a higher risk that the counterparty would not have collected sufficient funds to make the correct payments. When the money paid daily by suppliers is more than the payments to CfD generators for a particular day the surplus will be transferred to (and held) in the reserve fund.

⁷⁸ Based on a very high two-month wind generation event, using the most extreme load factors recorded between 1970 and 2012 for March and April (71% onshore, 63% offshore)

⁷⁹ Based on the low fossil fuel price scenario from the DECC's Updated Emissions Projections (UEP)

254. Suppliers will contribute to the reserve fund in proportion to their market share, which will be based on their average market share in the month prior to the reserve fund requirement being calculated by the counterparty. They will be informed of the estimated closing balance for the current year's reserve fund and given at least three months' notice of the size of the reserve fund for the following year and their anticipated contribution. They will be notified of the estimated amounts due for the following year's reserve fund at the same time that the £/MWh unit fixed rate is announced. New entrants to the market, that start supplying electricity part way through the year, will be required to make reserve fund payments based on their market share for their first months' worth of supply data.

Most relevant sections of the draft instruments that relate to this section

Regulations 10, 12 and 13 in The Contracts for Difference (Supplier Obligation) Regulations

Reserve Fund	
Question CFD16	What are your views on the approach to sizing the reserve fund?
Question CFD17	Do you have any comments on how to fund the reserve fund? What funding options will ensure the Counterparty has sufficient funds to cope with unexpected events and smooth payments?
Question CFD18	Do you have any comments on the approach to determining market share for payment of the reserve fund?
Question CFD19	Do you have any comments on the timings outlined for notification of the amount of money required for the reserve fund?

3.3.6 Reserve Fund Reconciliation

255. In order to accurately manage accounts for the reserve fund, reconciliation will take place in May each year, with payments due by 1 July each year. This

approach ensures that the Counterparty will have time to accurately assess the end of year balance and will maintain sufficient funds during the period between the end of the levy year (31 March) and the date at which the new reserve will be set and collected. This three month window is required to allow the Counterparty to finalise its annual accounts and for supply and generation data relating to the preceding year to be reconciled to a point at which it is reasonably accurate, allowing the next reserve payment to be calculated.

256. To carry out this process the counterparty will reconcile and confirm individual suppliers' overall 'contribution' to the reserve fund's closing balance. An individual supplier's reserve fund balance will be the cumulative difference between its total net payments to the counterparty (both its initial reserve fund payment and daily payments at the unit cost fixed rate) and the actual levy as per the Levy Formula set in legislation.
257. The counterparty will use the above reconciliation as a basis for calculating how much each supplier will contribute (or be refunded) to the reserve fund for the following year. Suppliers will then be billed (or refunded) this amount. Any amounts due to suppliers because their current balance is larger than the contribution required for the following year will be refunded through a credit note against future unit fixed rate payments.
258. To aid reconciliation and to ensure that suppliers are paying the correct amount the counterparty will track and monitor each suppliers' unit cost fixed rate payments and contributions to the reserve fund. This will result in each supplier having a 'virtual' balance in the reserve fund.

Most relevant sections of the draft instruments that relate to this section

Regulations 10, 12 and 13 in The Contracts for Difference (Supplier Obligation) Regulations

Reconciliation

Question CFD20

Do you have any comments on the frequency of reserve fund reconciliation?

3.3.7 Settlement Process for Suppliers and BSC registered Generators

259. The settlement process for the supplier obligation and for BSC connected generators will use metered data calculated according to the BSC and provided from BSC data systems. The Settlement agent will use the data provided by the BSC, which will be a mixture of profiled data based on estimated consumption and half hourly metered consumption data soon after the billing period. Supplier consumption data will be defined as all electricity imported from the total electricity system for which a Licensed Supplier is responsible under the BSC, loss adjusted for transmission and, if appropriate, distribution losses, net of any electricity exempted through the Energy Intensive Industries exemption. For the calculation of CfD payments for generators, generation calculated will be net of all 'input electricity' as well as loss adjusted for transmission and, if appropriate, distribution losses.

260. **Figure 3.8** Overview of settlement process for suppliers and generators:

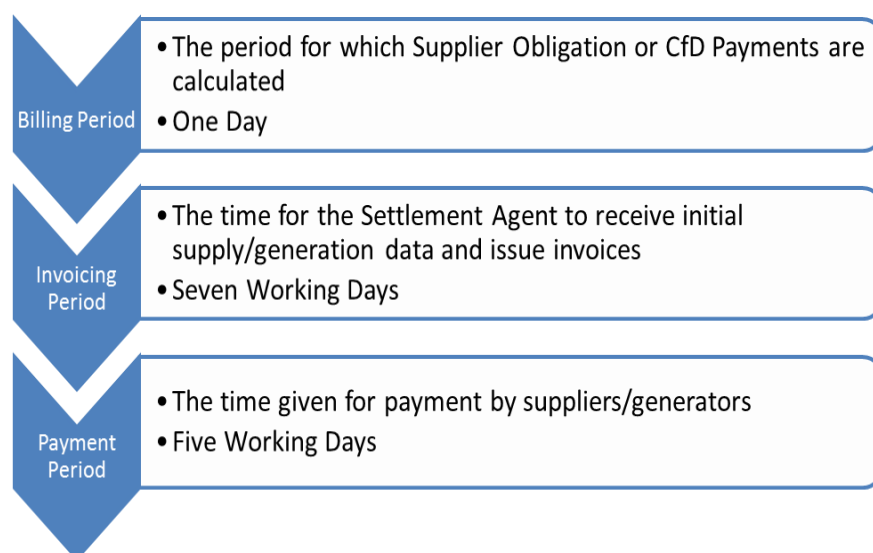

261. **Billing period – One Day:** To align with BSC settlement processes in order to keep administrative costs low and to keep the settlement process short in order to reduce the burden of collateral, we will settle the supplier obligation and CfD Payments to generators daily with payments being made each business day making a one day billing period, coinciding with the BSC's Settlement Day⁸⁰. Smaller generators who are not already a Party to the BSC will need to ensure that their systems are able to cope with daily settlement, but the additional administrative costs of settling daily will be more than offset by the reduced collateral cost. Generators will also see the cash flow benefit of daily settlement.

⁸⁰ Under the BSC, payments for Trading Charges are made for a Settlement Day (made up of 48 half hour Settlement Periods except on days where the clocks change).

262. **Invoicing Period – Seven Working Days:** Under the BSC, the initial settlement invoice is issued based on Initial Settlement (SF) Run metered data which are available sixteen working days after the Settlement Day. However, the BSC provides earlier metered data than the SF Run. The Interim Information (II) Run is available five working days after the Settlement Day. In order to further shorten the period for which collateral needs to be provided, we will base the initial supplier obligation and CfD payment invoice on the earlier II data. Analysis of data from ELEXON Ltd shows that on average the difference between the II and SF runs is minimal with approximately 50% of electricity data of either run being based on meter readings, rather than profiled data. Furthermore, the use of the II run is only for the issuing for the initial invoice and so the initial payment. Payments will continue to be reconciled following the BSC calendar as more accurate data comes forward. Use of the II run will reduce collateral requirements by two weeks compared to use of the SF run. The Settlement agent will require a further two working days to perform the calculations and issue invoices, creating a seven business day invoicing period.
263. **Payment Period – Five Working Days:** The BSC requires that Parties are given no less than three working days to pay Trading Charges. Given the larger size of supplier obligation payments compared to Trading Charges, we will give suppliers (or generators where they are due to make payments to the Counterparty) five working days to make this payment, ensuring that suppliers and generators are able to audit invoices and make payments using the cheaper BACS method if they wish.
264. This will be netted off the total due in that invoice. Where BSC SF or reconciliation runs take place in levy years after the one including the billing period to which they refer, any under or over payments by suppliers will be corrected through adjustment of the amount held in each supplier's reserve account. Suppliers will be notified of the amount held in this account at least quarterly and will receive payments, or be required to make payments, to reconcile this account annually.
265. For generators, updated generation data will be provided by the BSC systems in the same way as for suppliers over a 14 month period. The Settlement agent will use this reconciled data from each of the SF and reconciliation runs and will recalculate whether the appropriate CfD payment for that billing period had been made. Generators will be informed of these reconciliation calculations in the next available invoice and any amended payments will be added or netted from the total cost of that invoice. It is anticipated that this reconciliation process will survive termination of the CfD.
266. As tax revenue, supplier obligation payments must be held securely in the Government Banking Service. The counterparty will not earn interest on non-

collateral sums held and so interest will not be charged to suppliers or paid to suppliers when data reconciliations for the supplier obligation take place.

Most relevant sections of the draft instruments that relate to this section

Regulations 3, 5, 6, in The Contracts for Difference (Supplier Obligation) Regulations

Settlement	
Question CFD21	Do you have any comments on the reduced settlement timescale?
Question CFD22	Do you have any comments on the use of the BSC's Interim Information Run for the first supplier obligation invoice?
Question CFD23	Do you have any comments on how the Minimum Required Collateral should be calculated?
Question CFD24	Do you have any comment on how many working days will be sufficient to make payments to the counterparty, given the fact that longer payment periods would increase collateral requirements?
Question CFD25	Do you have a view on whether the settlement process (including lengths of billing period, invoicing period and payment period) should be the same for suppliers and generators, as currently proposed?

3.3.8 Supplier collateral required through the Supplier obligation

267. The supplier obligation must be robust enough to ensure that payments to generators continue in the event of supplier default. One of the tools to give greater confidence is the provision of collateral by suppliers. However, collateral has a cost, and Government's policy proposals have been designed to be mindful of this cost and to minimise the posting of collateral where possible, without damaging confidence in the regime.
268. All suppliers will be required to post collateral to cover their upcoming supplier obligation liabilities: the cumulative amount for which they are liable, at any

point in time, from the billing period to when payment is due. To reduce the burden of collateral while providing the necessary payment certainty to generators, we are proposing what we believe is the shortest practical settlement process, as set out in the Settlement Process section above. In brief, collateral will need to cover:

- a billing period of 1 business day;
- an invoicing period of 7 business days;
- a payment period of 5 business days; and
- a 2 business day payment rectification period;

269. Accordingly, suppliers will be required to post collateral to cover a 15 business day period. In addition, a 6 day allowance must be made for weekends as, in most cases, the 15 day period set out above will cover three weekends (i.e. 6 days). In total, the collateral requirement will cover a period of 21 days (15 business days plus 6 weekend days). When compared to the collateral requirements proposed in the November 2012 publication, the proposal of a 21 day collateral period results in a reduction of the collateral period of almost one month.

270. In order further to reduce the cost of providing collateral, this 21 day collateral cover period does not include bank holidays. Where the 21 day collateral cover period falls over a bank holiday, the collateral requirement will increase by the number of bank holiday days only in that period. Suppliers will be notified of this by the settlement agent.

271. As a supplier's collateral requirements will reflect the payments for which it is liable, they will change in light of changes in its market share and seasonal variations in electricity requirements. In order to make it as simple as possible for suppliers to know how much collateral they need to provide in any 21 day period, we are proposing to use past supplier obligation invoices as a proxy for a supplier's upcoming liabilities. The settlement agent will calculate the minimum amount of collateral cover that a supplier needs to have posted for the upcoming 21 day period using the total amount of supplier obligation payments due for the last twenty-one days as already invoiced to that supplier. This figure will be communicated daily to each supplier, giving early warning for suppliers to increase or extend existing letters of credit or post additional cash collateral

272. Supply data do not change dramatically day to day and the use of a rolling total should reduce the impact of individual spikes or dips in supply on a particular day. It should also mean that longer term shifts in patterns of supply should begin to be picked up by the rolling total after 8 working days. Analysis

- by ELEXON Ltd on the application of such a system to the BSC found that it would lead to improved accuracy of collateral calculations compared to the existing BSC collateral calculation.
273. In many cases, suppliers may choose to provide collateral cover through a long term letter of credit rather than cash in response to short-term notifications by the settlement agent. Suppliers are best placed to know how much electricity they are expecting to provide over the upcoming months and so we would expect suppliers to use this knowledge to judge how much collateral to post.
274. As well as monitoring the amount of collateral already provided and the minimum amount required, the settlement agent will also monitor the continuing validity of letters of credit and notify suppliers in advance of expiry and if their issuing bank's credit rating falls below the minimum requirement. In line with the requirements of the BSC, suppliers will be notified of expiry twenty working days before the letter of credit is due to expire and will need to provide confirmation that the letter of credit will be extended or replaced at least ten working days before expiry. Where the credit rating of the issuing bank falls below the minimum credit rating, suppliers will have ten working days to provide a new valid letter of credit or provide cash collateral.
275. Where suppliers find themselves over-collateralised, they will be able to request that the counterparty refunds part of their current collateral cover (where it is provided in cash). Where it is provided through letters of credit, the supplier may request that an existing letter of credit be replaced by a more limited one. Refunds in this way will take place within two working days following such a request from a supplier. This calculation is performed by the settlement agent on a daily basis.
276. Collateral must be sufficiently liquid to ensure that the counterparty has the funds required to pay generators. Equally, cost to suppliers must be minimised where possible. Accordingly, suppliers will be able to provide collateral either in cash or in the form of a Letter of Credit from a bank with a minimum credit rating of A- (Standard and Poor's) or A3 (Moody's). If the minimum required credit rating becomes unsustainable, we might review the rating requirement. We have considered whether parent company guarantees (PCGs) could constitute an appropriate form of collateral. However, due to constraints around liquidity and the consistency in minimum credit ratings applicable to PCGs they have not been included as an appropriate collateral instrument.
277. We expect that any cash collateral provided will be held in an interest bearing bank account within the Government Banking Service (GBS) at the GBS

- interest rate. Any interest will be distributed once per year to the suppliers who have provided the cash collateral.⁸¹
278. If a supplier's posted collateral cover falls below the minimum requirement (either because of a payment default leading to a reduction in the available posted collateral or because their minimum collateral requirements have increased), a notification will be provided by the settlement agent requiring immediate top-up of collateral. Suppliers will have until 2pm two working days after this notification to increase their collateral level, either by depositing cash collateral, increasing collateral cover through letters of credit, or paying any outstanding amounts due. This rectification period is longer than under the BSC. Given that the collateral system under supplier obligation is simpler than that under the BSC, we can afford to allow suppliers a longer rectification period.
279. If, by the deadline, the supplier's collateral cover is still below the minimum requirement, the supplier will be considered to be in default and the counterparty will be able to take enforcement action and will notify the supplier that they are doing so. These actions include reporting the default to Ofgem and the counterparty pursuing the debt in the courts.
280. The current impact assessment reflects the average total collateral requirement from 2016 to 2020 as a range between £135 million and £200 million. The minimum figure is based on a reference price scenario⁸² and the maximum figure is based on a low fossil fuel scenario⁸³, which is the most extreme expected scenario and would ensure that the counterparty has sufficient collateral cover in place. Similarly, the annual average cost to suppliers of financing collateral is estimated to be between £9 million and £14 million, while the cost to consumers is estimated to be between £0.11 and £0.17, both for the period 2016-2020.
281. We have considered whether there should be the ability for collateral to be shared across the Contracts for Difference and Capacity Mechanism schemes, and between suppliers and generators. Under our current proposals, each supplier and generator will be required to post collateral to cover the full extent of their respective obligations in order to ensure that all

⁸¹ Under the standard terms of the Government Banking Service, interest is not earned. However, different arrangements are put in place for the holding of collateral and so interest will be earned in this instance.

⁸² Consistent with the analysis for Electricity Market Reform published in January 2013 (based on an assumed carbon emissions intensity of 100gCO₂/kWh in 2030 and central assumptions on demand, fossil fuel prices and generation costs)

⁸³ Based on the low fossil fuel price scenario from the DECC's Updated Emissions Projections (UEP)

payment obligations are covered and reduce the risk of the counterparty of not being able to make payment when due. We would welcome views on this approach.

282. Generators will be required to provide collateral to cover payments to suppliers when payment flows are reversed, i.e. where the CfD reference price is higher the strike price. The provision of collateral by generators will be a requirement of the CfD contract.

Most relevant sections of the draft instruments that relate to this section

Regulations 14 and 15 in The Contracts for Difference (Supplier Obligation) Regulations

Collateral	
Question CFD26	Do you have any comments on the amount of time necessary to size collateral requirements?
Question CFD27	Do you have any comments on the length of the late payment rectification period?
Question CFD28	Do you have any comments on the form of collateral, such as cash or a letter of credit as proposed?
Question CFD29	Do you have any comments on the proposed credit rating requirements for letters of credit?
Question CFD30	Do you have any comments on the process for monitoring and enforcing credit requirements?
Question CFD31	Do you have any comments on the approach to sharing of collateral across the Contracts for Difference and Capacity Mechanisms schemes, and between suppliers and generator? What alternatives would you propose and how would this mitigate the risk of non-payment by the counterparty?

Question CFD32	Do you have any questions or comments on regulations 14 (Collateral) and 15 (Calculation of a suppliers collateral requirement)?
-----------------------	--

3.3.9 Insolvency reserve fund – size and when this can be accessed

283. As set out in the August supplier obligation publication⁸⁴ the Government has considered whether further arrangements are necessary to deal with the unlikely event of a supplier becoming insolvent and that resulting in a short-term funding gap between the exhaustion of collateral (following non-payment) and any enduring solution for the supplier's customers, such as Supplier of Last Resort (SoLR)⁸⁵.
284. Historic BSC data shows the total unsecured losses from suppliers as a result of defaults and insolvencies over the past eight years (2004-2011) has been around 0.26% of the Balancing and Settlement Code revenue, thanks to robust credit and collateral arrangements. We therefore consider unsecured losses under the supplier obligation unlikely to arise. If they did, an insolvency reserve fund would allow the counterparty to continue to make payments to generators. Given that the insolvency reserve fund is a new and untested mechanism, Government must strike a balance between the requirement of the fund to enhance generator payment certainty and the cost to suppliers of providing a fund that would be utilised only in exceptional cases.
285. The counterparty will determine the size of the insolvency reserve fund annually based on the formula set out in regulation 17(6) of the draft instruments published alongside this document. Suppliers will be notified of their required insolvency reserve fund contributions at the same time that the annual levy rate is announced, which is at least three months before the beginning of each annual levy rate period. In order to reduce the risk of a funding shortfall, the insolvency reserve fund will need to be fully funded, by way of a lump sum payment, when the scheme starts.

⁸⁴ https://www.gov.uk/government/uploads/system/uploads/attachment_data/file/226897/CfD_Supplier_Obligation_-_policy_update_and_response_to_the_call_for_evidence_-_7_August_2013_-_FINAL.pdf

⁸⁵ [Please follow this link to Ofgem's revised guidance on the supplier of last resort.](#)

286. It is currently proposed that the fund will be sized to cover payment default by the three largest small suppliers⁸⁶ for 38 calendar days, based on the forecast CfD payments. Small suppliers are identified as suppliers with a current market share of less than 10%. The insolvency reserve fund will be sized on small suppliers' payments because of the reduced probability of default by larger suppliers. The 38 days represents a reasonable period from when a defaulting supplier's collateral is exhausted to the time when a SoLR has been appointed and is making the relevant levy payments. Suppliers' percentage contributions to the insolvency reserve fund will be in proportion to their market share according to the most recent monthly trading data.
287. The utilisation of the insolvency reserve fund is covered in regulations 16(13), 16(14) and 16(16). The fund will be drawn upon once a defaulting supplier's collateral is fully exhausted. A defaulting supplier's contribution to the fund will be fully utilised before the contributions of the non-defaulting suppliers. Once utilised, the contributions of the non-defaulting suppliers will be drawn upon proportionately. Where the counterparty intends to call the letters of credit of non-defaulting suppliers, suppliers will be given 24 hours' notice by the counterparty. Supplier will have the opportunity to replace the letter of credit with cash, within the 24 hour period, to ensure that its credit status is not affected by calling the letter of credit.
288. In the case of a new supplier entering the market or an existing supplier making a planned exit from the market, the counterparty will re-determine the insolvency reserve fund contributions of the remaining suppliers. Where suppliers are required to increase their insolvency reserve fund contribution, they must do so within 5 business days of being notified of their increased contribution. Where the re-determination leads to a reduction of a supplier's insolvency reserve fund contribution, the counterparty must repay excess contributions within 5 business days of being requested to do so by the relevant supplier.
289. As for collateral, and for the same reasons of balancing payment certainty for generators against minimising costs to suppliers, the insolvency reserve fund will be funded by cash or Letters of Credit. Letters of Credit must be issued by a bank with a minimum credit rating of A- (Standard and Poor's) or A3 (Moody's). Where the credit rating of the issuing bank falls below the minimum required credit rating, suppliers will have 10 working days to provide a new valid letter of credit or provide cash collateral. As for collateral, if the minimum required credit rating becomes unsustainable, we might review the rating requirement. We expect that any cash provided into the insolvency

⁸⁶ The three largest small suppliers represent the 7th, 8th and 9th largest suppliers ranked by market share.

reserve fund will be held in an interest bearing bank account within the Government Banking Service at the GBS interest rate. Any interest will be distributed once per year to the suppliers who provided this cash.

290. When the insolvency reserve fund is called upon, non-defaulting suppliers will be required to replenish the fund through mutualisation.
291. The current impact assessment reflects the annual average size of the insolvency reserve fund from 2016 to 2020 as a range between £14 million and £21 million. The minimum figure is based on a reference price scenario and the maximum figure is based on a low fossil fuel scenario, which is most extreme expected scenario and would ensure that the fund is adequately sized in this unlikely event. Similarly, the annual average cost to suppliers of financing the fund is estimated to be £1 million, while the cost to consumers is estimated to be between £0.01 and £0.02 over the period 2016-2020.

Insolvency Reserve Fund	
Question CFD33	Do you have any comments on the concept of an insolvency reserve fund; if not what alternatives would you recommend to manage the associated risk?
Question CFD34	Do you have any comments on how to size the insolvency reserve fund?
Question CFD35	Do you have any comments on the most appropriate means of funding the insolvency reserve fund?
Question CFD36	Do you have any comments on the minimum credit requirements for letters of credit used to fund the insolvency reserve fund?
Question CFD37	Do you have any comments on the length of notice period given to a non-defaulting supplier to replace a letter of credit with cash before it is called by the counterparty?
Question CFD38	Do you have any questions or comments on regulations 16 (Insolvency reserve collateral), 17 (Calculation of a supplier's insolvency reserve requirement) and 18 (Repayment of insolvency reserve collateral)?

Most relevant sections of the draft instruments that relate to this section

Regulations 16-18, in The Contracts for Difference (Supplier Obligation) Regulations

3.3.10 Mutualisation

292. Mutualisation is the process through which any outstanding supplier obligation payments owed by a defaulting supplier are recovered from the remaining suppliers. The mutualisation process begins once a defaulting supplier's collateral has been fully exhausted and the insolvency reserve fund is utilised (as described above). In essence, mutualisation is the 'topping up' of the insolvency reserve fund as it is used, in order to ensure that it remains fully funded. Mutualisation will end when an enduring solution for the defaulting supplier is found, such as the appointment of a Supplier of Last Resort (SoLR) in the event of insolvency.
293. The rules on mutualisation are set out in regulation 16 of the draft instruments accompanying this document. Non-defaulting suppliers will be notified by the settlement agent that mutualisation is due to occur three business days after the insolvency reserve fund is drawn upon and will have five business days to pay their mutualisation contributions. These timescales will allow the non-defaulting suppliers to make the required internal arrangements to fund their mutualisation contributions.
294. The amount each supplier must pay will be based on the amount of money withdrawn from the risk fund, divided by the market share of each supplier for the billing day to which the default relates.
295. In order to reduce the administrative burden on the counterparty and to align with the current processes under the BSC, all outstanding debts will be mutualised. However, we would be welcome views on whether a minimum threshold should apply before outstanding debts are mutualised.
296. Where mutualisation payments (or a portion thereof) are later recovered, it is proposed that they will be returned to the suppliers that participated in the mutualisation within 5 business days after payments have been recovered. These monies would be allocated in proportion to each supplier's contribution to the mutualisation event(s).

Most relevant sections of the draft instruments that relates to this section

Regulation 16, in The Contracts for Difference (Supplier Obligation) Regulations

Mutualisation	
Question CFD39	Do you have any comments on the concept of mutualisation, if not what alternative mechanism would you propose to ensure the insolvency reserve fund remains adequately funded?
Question CFD40	Do you have any comments on whether suppliers should pay towards mutualisation in proportion to their market share?
Question CFD41	Do you have any comments on whether there should be a minimum threshold for an outstanding debt before mutualisation begins? If so what threshold amount would you propose and how would this operate to ensure that the risk balance to the counterparty remains the same?
Question CFD42	Do you have any comments on the use of recovered funds?
Question CFD43	Do you any questions or comments on regulation 16 (Insolvency reserve collateral)?

3.3.11 Arrangements for dealing with non-payment

297. The requirements on suppliers to make levy, reserve fund, collateral and insolvency reserve fund payments will be requirements of the electricity supply licence issued to suppliers under the Electricity Act 1989.
298. Where a supplier is in payment default the counterparty will register the non-payment with Ofgem within 2 calendar days as an early warning that the supplier may be in financial distress. Should the supplier not remedy a default within a further five calendar days, the counterparty will formally report non-payment to Ofgem as a breach of a relevant requirement. This means Ofgem may use its powers under section 25 to 28 of the Electricity Act 1989 to enforce the requirements of the supplier obligation, as it would with a breach of a supplier's licence. Ofgem will consider the report and relevant circumstances and take whatever action it deems necessary, which, if the supplier is declared insolvent, could lead to a revocation of the defaulting suppliers licence and the appointment of a Supplier of Last Resort (SoLR).

299. The SoLR would not be liable for debts of the defaulting supplier that accrue before the SoLR is appointed. These debts may be recovered from the administrators of the insolvent supplier in the ordinary course of the insolvency process.
300. If a large supplier became insolvent then Government may apply to the court for an energy supply company administration order. An energy administrator is then appointed by the court to run the company until it is either rescued, sold or its customers transferred to other suppliers. The energy administrator is under an obligation to comply with all licence conditions, and will therefore be responsible for ensuring that debts that have arisen in relation to licence conditions prior to the company entering energy supply company administration are paid. The Government has powers to provide financial aid or loans to the energy administrator in order to ensure the effective functioning of the market. This is different from the Supplier of Last Resort process regime where the supplier taking on the failed supplier's customers is responsible for liabilities in relation to licence conditions only from the date that the customers are transferred.
301. Where a supplier is in payment default which does not lead to insolvency, the counterparty may pursue any unpaid obligations as a debt in civil court. At present, we propose that the counterparty will have discretion over whether to pursue any outstanding debts through the courts. Our initial thinking is that this discretion must be based on an assessment of the associated cost and the likelihood of success. Nevertheless, the counterparty must always do what it thinks is best to recover outstanding debts. We would welcome views on this approach.
302. We are considering whether the notification of payment or credit default by a supplier should be published on the counterparty's website. This would provide all suppliers with early visibility of the potential that the insolvency reserve fund may need to be used in future and mirrors similar processes in the BSC.

Most relevant sections of the draft instruments that relate to this section

Regulation 19 in The Contracts for Difference (Supplier Obligation) Regulations

Arrangements for dealing with non-payment

Question CFD44

Do you have any comments on the proposed timescales

	for notifying and reporting payment default to Ofgem?
Question CFD45	Do you have any comment on the approach to the enforcement of debts through the courts by the counterparty?
Question CFD46	Do you have any questions or comments on regulation 19 (Enforcement of requirements)?

3.3.12 Disputes

303. Where a supplier or generator disputes the generation or supply data used by the Counterparty – i.e. metered data - it will be taken forward as a dispute under the relevant BSC procedures.
304. Suppliers would be able to dispute a notice given by the counterparty about a non-payment by setting out the basis on which they dispute the notice, in writing, to the counterparty within 28 calendar days of the notice of non-payment.
305. On receipt of a dispute from a supplier the counterparty would, within 28 calendar days of receipt, determine whether it should have issued the notice and, if so, whether the notice was correct.
306. Where the counterparty determines that it should not have issued the notice to the supplier it would be required to notify Ofgem of this fact. The counterparty would, within five working days, pay to the supplier any amount it had received from the supplier, or any amount recovered as a civil debt in relation to the notice. The counterparty would be required to notify any other supplier who it thinks is likely to have been affected by the determination, subject to appropriate confidentiality requirements.
307. Where the counterparty determines that the notice to the supplier was incorrect, it would be required to notify Ofgem of this fact and issue a new (correct) notice. The counterparty must, within five working days, pay to the supplier any amount it has received from the supplier or recovered as civil debt, less any amount required by the new notice and any amount recovered as a civil debt, less any amount required by the new notice. The counterparty would be required to notify any other supplier who it thinks is likely to have

been affected by the correction of the notice, subject to appropriate confidentiality requirements.

308. Suppliers may also dispute determinations made (or not made) by the counterparty in relation to:
- The amount of the levy due and how it has been calculated;
 - The amount of reserve fund payments/repayments due;
 - The amount of collateral to be paid/repaid;
 - The amount of insolvency reserve fund payments/repayments to be made; and
 - whether a letter of credit is an acceptable form of collateral.
309. Suppliers would be able to do this by setting out the basis on which they dispute the determination, in writing, to the counterparty within 28 calendar days of the determination being made, or the day on which it should have been made if it was not.
310. On receipt of a dispute the counterparty would be required to determine whether it should have made a determination where it did not, whether it should not have made a determination where it did, and whether it should have made a different determination. Within 28 calendar days it must make the determination and take the following steps:
- Issue a notice to the supplier setting out its determination of the dispute.
 - Send a copy of the determination to every other supplier who it thinks is likely to have been affected by it, subject to confidentiality requirements.
 - Publish, where required, a notice setting out the determination.
 - Make, where necessary, a new determination to replace the one that was incorrect and is now void.
311. The above processes relate to disputes about whether the counterparty has correctly applied the regulations relating to the supplier obligation. If a supplier remains unsatisfied with the determination of the counterparty, or disputes the supplier obligation regulations, the supplier will need to consider making a claim in the civil courts, for example an application for Judicial Review.

Most relevant sections of the draft instruments that relate to this section

Regulations 20-23 in The Contracts for Difference (Supplier Obligation) Regulations

Disputes and Enforcement	
Question CFD47	Do you have any comment on proposed timescales within which suppliers must raise a dispute the counterparty for notifying and reporting payment default to Ofgem?
Question CFD48	Do you have any comments on the proposal that the notification of a payment or credit default by a supplier should be published on the counterparty's website?
Question CFD49	Do you have any questions or comments on regulation 20 (Disputes)?

3.3.13 CfD Payments from generators

312. The rules and processes for CfD payments from generators are set out in the CfD contract. The counterparty may continue to collect payments from suppliers, for example reserve fund payments and calls for collateral, when the strike price exceeds the reference price. The counterparty may also receive payments from a generator where a CfD is terminated. The size and timing of any termination payment will be determined in line with the CfD contract.
313. Where the counterparty receives a payment from a generator, with the exception of compensation payments⁸⁷, the counterparty will pay that amount to suppliers as soon as possible following reconciliation at the end of the year, so avoiding disruption to payment flows. The payments to suppliers will be calculated in proportion to the amount of electricity they supplied in the period to which the payment from the generator relates.

3.3.14 Exemption for Energy Intensive Industries (EIs)

⁸⁷ A compensation payment is where a generator compensates the Counterparty for the costs incurred as a result of a generator's failure to comply with a CfD.

314. The Government intends to implement an exemption for the most Electricity Intensive Industries (EII) from some of the costs of CfDs where they pose a significant risk to UK competitiveness, subject to state aid approval. We are seeking to strike the right balance between targeting those industries most at risk and minimising additional costs to other consumers.
315. As set out above, the costs of CfDs will be met by licensed electricity suppliers via the supplier obligation. This cost is likely to be passed to consumers, and evidence suggests that this cost, when considered cumulatively with other policies to incentivise investment in the UK's energy infrastructure, could put at risk the competitiveness of EII in the UK. These industries are significant employers and contribute to the low carbon economy through the products they manufacture.
316. In a consultation⁸⁸ over the summer the Government proposed to exempt the most electricity intensive EII from a proportion of the costs of CfDs. Our aim is to "level the playing field" so that our EII are not made uncompetitive due to the costs of this policy. This exemption, taken with compensation schemes from the indirect costs associated with the EU Emissions Trading System (EU ETS) and Carbon Price Support mechanism which are already being progressed, will help to achieve that aim.
317. CfDs and exemptions from CfDs are subject to state aid approval. Due to uncertainty around timing issues relating to state aid approval for CfDs, it will not be possible to implement the exemption when the CfD regime begins. Instead we expect to lay enabling regulations to give effect to the exemption in England, Scotland and Wales in April 2015. The same date could apply to Northern Ireland, however this is dependent on when CfD costs commence in relation to suppliers in Northern Ireland. This may mean some cost to EII in 2014-2015 from CfDs, but it is expected that the cost per MWh would be very low, estimated at £0.05/MWh⁸⁹. In contrast, in 2020 EMR support costs could add up to £10/MWh to large energy intensive users' electricity prices.⁹⁰
318. The Government is carefully considering the responses to the recent consultation on how eligibility for an exemption from the costs of CfDs should be determined. We will publish a Government response to the consultation

⁸⁸ <https://www.gov.uk/government/consultations/electricity-market-reform-contracts-for-difference-costs-exemption-eligibility>

⁸⁹ Assuming a £15m administrative cost in 2015 across approximately 288 TWh's of electricity sales in 2015, resulting in a price impact of £0.05/MWh.

⁹⁰ Figure 2 at

https://www.gov.uk/government/uploads/system/uploads/attachment_data/file/232224/bis-13-1137-electricity-market-reform-eligibility-for-exemption-from-the-costs-of-contracts-for-difference-updated-cost-estimates.pdf

before the end of the year, alongside draft regulations to implement the exemption and a full impact assessment. We will engage with industry, consumer groups and the Devolved Administrations on implementing the exemption.

3.3.15 Counterparty operational cost levy

319. A levy paid to the counterparty by suppliers will allow it to recover the operational costs it incurs in connection with the performance of its functions of administering CfDs⁹¹. This would include, for instance, staff, estate and IT costs, as well as potential legal fees in relation to dispute resolution. Payment of the operational cost levy will be a relevant requirement and as such will be enforceable by Ofgem as if any breach were a breach of a licence condition..
320. In order to reduce administrative costs for suppliers and the counterparty, we have designed the operational cost element, as far as possible, to be invoiced and collected alongside the supplier obligation which will be used to fund payments under CfDs. At the same time we will provide maximum transparency over what element is used to pay for operational costs and therefore the operational cost share will appear as a separate line on the invoice. A fixed levy rate (£/MWh of electricity supplied) will be charged which will be set in Regulations in advance of each levy period, following a public consultation, as described in further detail below.
321. Government will pay for the set-up costs of the counterparty, in line with Government guidelines for managing public money⁹². Suppliers will be liable for the costs of the counterparty once it becomes operational, which is expected to be from July 2014 (broadly, once secondary legislation has come into force). The timing and extent of the counterparty's duties are still being considered and will become clearer in the period up to its establishment. As set out earlier in this chapter, this includes, for example, contract modifications before a generator applies for a CfD and the date when Investment Contracts are transferred to the counterparty. Nevertheless, to allow for accurately planning a fixed rate levy, we assume that the counterparty will be operational in July 2014.

⁹¹ The power to collect such costs from suppliers arises from Chapter 2, clause 9.2 of the Energy Bill. Available at: http://www.publications.parliament.uk/pa/bills/lbill/2013-2014/0048/lbill_2013-20140048_en_1.htm

⁹² Where appropriate, capital expenditure incurred during the set-up phase will be recovered through depreciation by being built into the levy rate.

322. The operational cost levy will be collected daily along with the supplier obligation. It will use the same settlement systems, market share data and invoices as the main levy. The levy rate will usually apply for a financial year, i.e. 1 April to 31 March. The envisaged timings of budget consultation and levy setting are set out below.
323. For the first financial year of operation (2014/15), a slightly different approach to collection is necessary. Between July 2014 and the start of payments, Government will provide the counterparty with the working capital required to allow it to continue operating. This working capital provided by Government will be recovered from suppliers through the operational cost levy at the point at which or before CfD payments start under the supplier obligation. From the point at which payment systems are in place, suppliers will pay their share of the operational costs on a daily basis. In addition, at the end of each month, until the end of the financial year, they will pay the appropriate proportion of the operational costs accrued since July 2014, resulting in a number of lump sum monthly payments on top of daily payments. Alternatively, the counterparty may collect the accrued amounts as one lump sum towards the end of the financial year. An update on when payments will commence will be provided by the end of the year.

3.3.16 Setting the operational cost levy rate

324. The levy rate will be calculated based on the counterparty's agreed annual budget divided by total estimated electricity supply in the same year, (having deducted the estimated supply to energy-intensive industries, subject to State Aid clearance. The EII exemption will only apply from 2015/16, as the necessary systems will not be in place for 2014/15). Since the rate is based on the counterparty's annual budget, it is highly likely that the rate will change every year. This will be done through an amendment to the principal regulations, subject to the affirmative procedure in Parliament. Very preliminary estimates suggest that operational costs will amount to around £15m in 2015/16. This estimate will be refined and reviewed over the coming months. We can expect that the operational costs of the counterparty will rise over time as it manages an increasing number of contracts.
325. Government will consult on the levy rate alongside the counterparty's proposed business plan for the year ahead. The consultation will be open for 4-6 weeks and the business plan will be expected to include a detailed profiled budget for the year ahead. The consultation will give interested parties early sight of expected costs and the levy rate, and provide an opportunity to scrutinise and challenge the proposed costs and rate. After consultation, an updated business plan will be submitted to Government for final approval.

326. We expect to consult in January 2014 for the 2014/15 budget⁹³, and in November each year for the following year's rate e.g. November 2014 for the 2015/16 rate. Suppliers and other parties will be given at least three months' notice of the rate before it starts to apply⁹⁴. The proposed timings are driven by the need to provide suppliers and other parties with reasonable notice or the level of the levy and the need to change secondary legislation in order to change the rate.
327. In the event that a proposed rate is rejected by Parliament during their scrutiny of the Regulations, or the laying of Regulations delayed as a result of the outcome of the consultation, the existing rate (where applicable) will continue to apply.

⁹³ The counterparty will not be including future indicative budgets within this consultation.

⁹⁴ From the date when the final business plan is published following consultation. An indication of what the rate is likely to be will be provided earlier through the draft business plan.

Figure 3.9: Timeframes for counterparty budget and operational cost levy setting

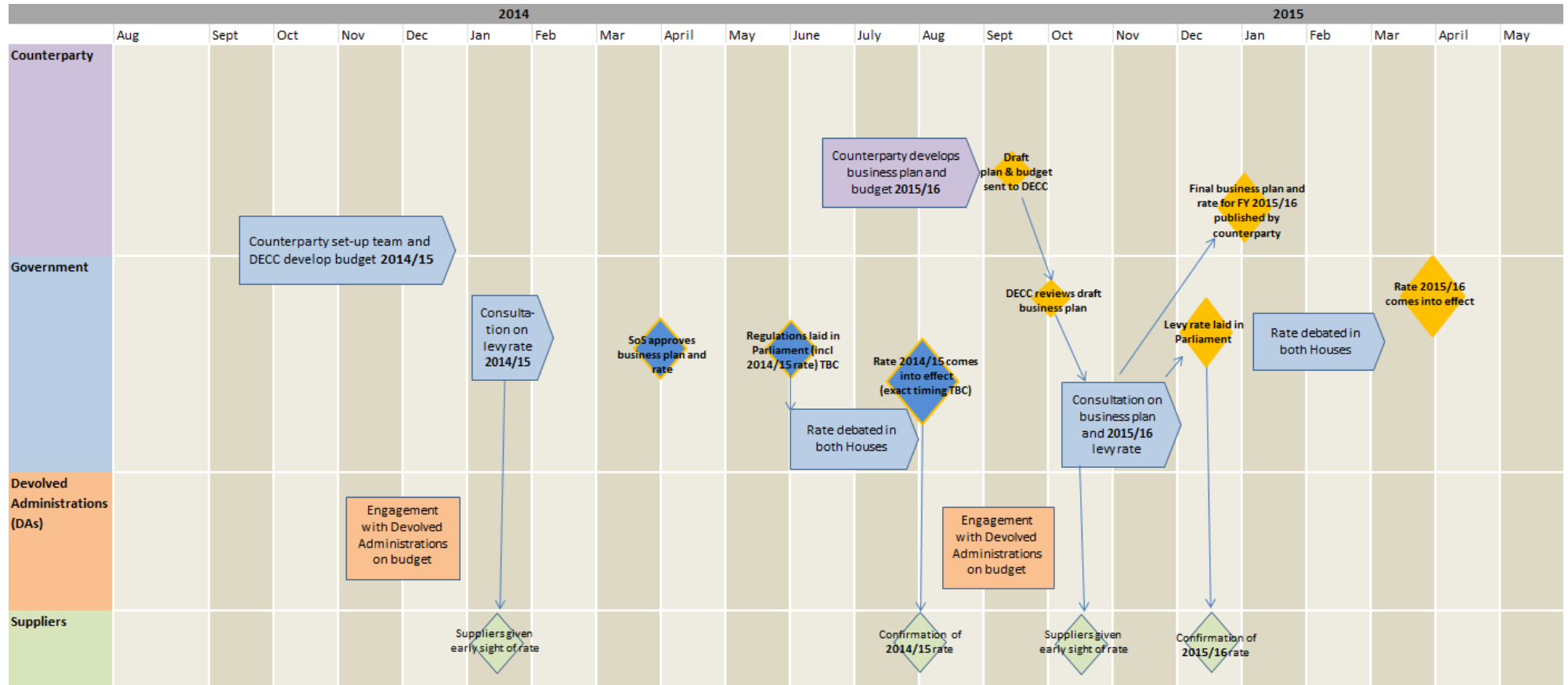

3.3.17 Reconciliation of operational cost payments

328. Market share data will be reconciled as under the supplier obligation, but only up to and including the 'Settlement Final run' (SF). This is known as 'Initial Volume Allocation run' in the Balancing and Settlement Code (Section U). As SF data will be used as final supply data, suppliers' share of operational costs will be partly based on estimates. Compared to what will be collected from suppliers under the supplier obligation for CfDs, the counterparty's operational costs will be small, and therefore we believe there is not the same need to reconcile data for 14 months. By using SF data, final market share figures will be available by June each year, before the counterparty is expected to finalise its accounts. The approach to use SF data as final data for the purposes of recovering running costs is also used by ELEXON Ltd under the Balancing and Settlement Code.

3.3.18 Managing budget risk

329. As the levy rate is based on estimates of the counterparty's expenses and overall electricity supply, the amount that is collected may not match actual expenditure. Government will look to the counterparty to manage its costs from within its own budget, including re-prioritising spend where necessary. We recognise that this may not always be possible and will put arrangements in place to ensure that the counterparty remains insolvency remote if the levy is not sufficient to meet its expenditure. Where appropriate, Government may provide the counterparty with a Grant-in-Aid, and it will be able to access working capital if necessary. Government may also increase the levy in-year if there is a significant discrepancy between the levy income and expenses, but we would consult on this and seek Parliamentary approval prior to any change.
330. We do not intend for the counterparty to have a surplus of income over expenditure. However, if expenditure is less than income from the levy any surplus at year-end will be refunded to suppliers. If the counterparty assesses that it is likely to have a surplus at year end, it will notify suppliers of this fact. It will also undertake to confirm the value of any refunds as soon as possible after the particular year-end when its accounts are finalised and the reconciliation of metering data is corrected for major errors (i.e. the 'SF run' has been completed). The rebate will be based on suppliers' overall market share in the financial year, as determined by the BSCCo, and will be reimbursed through the issue of Credit Notes which will reduce suppliers' cash payments in the following year between the date they are issued and the point at which they are exhausted. Relevant Credit Notes will be issued by the counterparty as soon as it is reasonably practicable after its accounts have been audited. The counterparty will consider ways of being transparent about its costs throughout the year, to help suppliers assess the likelihood of a refund.

3.3.19 Enforcement

331. The arrangements for enforcement of payment obligations are set out in Chapter 5 of the draft supplier obligation and operational cost regulations. As the counterparty may receive working capital from Government in order to manage cash flow issues arising from a payment default or otherwise (for operational costs only) it is not necessary to collect or use collateral and insolvency reserve payments for the operational cost levy. A default in operational cost payments will not lead to mutualisation of the outstanding debt across other suppliers. However, the counterparty will be able to pursue debts through the courts.
332. As previously mentioned, the supplier obligation levy and operational cost levy will be invoiced jointly. If a supplier only pays part of its bill, the part payment will count as a payment for the CfD rather than for operational costs. This prioritisation is necessary to secure payments to generators. However, the operational cost share of an invoice cannot be used to cover defaults in supplier obligation payments relating to an earlier bill date (such defaults are managed with collateral and other backstops as described above).

3.3.20 Dispute resolution

333. Should a dispute arise in relation to the operational cost levy, different dispute resolution processes will apply depending on what the point of dispute is. If suppliers believe that they have been charged an incorrect amount, this could give rise to a metering dispute (i.e. that the market share assigned is incorrect) and will be resolved in the same way for both operational costs and the supplier obligation (see above).
334. If there is a dispute over the calculation or invoice or billing of a statement which is not due to metering, then the relevant supplier will raise the dispute with the counterparty directly as set out in above. The levy rate itself is set by Government and there will be an opportunity for stakeholders to challenge the proposed levy rate through the consultation process.

Most relevant sections of the draft instruments that relate to this section

Part 3 Operational costs – Chapter 7: Regulations 27-30 and Part 2 Supplier Obligation – Chapter 5: Regulations 19-23 in the Contracts for Difference (Supplier Obligation) Regulations

Question CFD50	Do you have any comments on what would be acceptable to use as the basis for calculating suppliers' share of operational costs?
Question CFD51	Taking into account the constraints that arise from the need to set the rate in legislation, do you have any views on the proposed timetable for both 2014/15 budget and enduring regime? For example, does the timetable give enough notice to suppliers of the levy rate that will apply?
Question CFD52	With regard to operational cost payments that are accrued between July and December 2014, do you have any comments on the proposed payment period and frequency for recovering these payments (i.e. in instalments payable by the end of each month from January to March)? Do you have any other preference e.g. lump sum payment for the accrued amount?

Section 3.4: Implementing the CfD payment model

3.4.1. The CfD Counterparty

335. This section sets out what the counterparty is and its responsibilities in delivering the CfD regime and its governance arrangements.

3.4.1.1 Roles of the CfD Counterparty

336. The counterparty's principal roles are to act as the counterparty to, and manage, Contracts for Difference, and also to manage the collection and payment of monies under the supplier obligation for the CfD regime. The counterparty will only undertake defined activities relating to the CfD regime.

337. The counterparty will contract with the settlement agent (ELEXON Ltd) to carry out certain settlement activities as its agent.

338. In relation to its role of managing Contracts for Difference, the counterparty will:

- Negotiate pre-signature small administrative changes ('adjustments') to the standard terms of a CfD;
- Sign contracts with generators once they are allocated by the EMR delivery body (National Grid);
- Monitor and manage the contracts over their lifetime which will include managing:

- Conditions Precedent,
- Change Control process,
- Change in Law requests,
- Contract Variations,
- Terminations,
- Providing information to the EMR delivery body and Government as appropriate.

339. In relation to its role in tax raising and settlement, the CfD Counterparty will:

- Manage ELEXON Ltd, who will be designated as the settlement agent working on behalf of the CfD Counterparty to deliver settlement services for CfDs;
- Forecast and set the unit cost fixed rate (for further details see Section 3.3 above);
- Manage payments between suppliers and generators including identifying when payments will start, data collection, calculating the value of payments to generators according to the formula within the Contract for Difference and the supplier obligation rules, raising money from suppliers and managing underpayment and collection of debts.

3.4.1.2 Governance and Constitution of the counterparty

340. The counterparty will be a private company limited by shares, established and wholly owned by the Secretary of State. A Government owned company strikes the right balance between the need to have sufficient independence to operate efficiently in its day to day activities once contracts are signed, and the need for Government to ensure that its policy is being delivered appropriately and responsibly.

341. The Counterparty and its directors will operate within two main frameworks: statutory controls and the corporate and company law governance framework.

342. In considering the level of controls to be established over the Counterparty, the intention is to:

- Ensure that for matters where Government wishes to retain decision-making, there are clear and transparent routes for escalation to the Secretary of State;
- Provide clarity on key issues such as the purpose and guiding principles of the company, the company's strategy, financial and performance monitoring;
- Give comfort to industry in the company's day to day functioning and decision-making;
- Provide a transparent structure;
- Ensure financial accountability to the Department of Energy and Climate Change's Permanent Secretary; and
- Allow for flexibility should the role of the company need to evolve.

3.4.1.3 The statutory framework for the CfD Counterparty

343. The duties of the CfD Counterparty will be designated to it by virtue of a designation order made under Clause 7 of the Energy Bill. The designation order constitutes secondary legislation, and will confer upon the CfD Counterparty company the powers and responsibilities contained within the Energy Bill.
344. The designation order will come into force at the same time as other secondary legislation under the Energy Bill, though as it is an administrative exercise it is not subject to this consultation.
345. It is the Government's intention that there will be only one CfD Counterparty. In the unlikely event that the CfD Counterparty fails, the ability to designate more than one counterparty is contained under Clause 7 of the Energy Bill in order to ensure a speedy transition to a new counterparty; the power can only be used in the limited circumstances set out to ensure that payments continue to flow.
346. The counterparty will enter into CfDs in two ways: it will be directed under powers in legislation by the Secretary of State to enter into CfDs and it will be allocated CfDs to enter into by the EMR delivery body. It does not choose which CfDs it enters into.
347. The CfD Counterparty will have, under the legislation, certain tax raising and settlement functions for the purposes of implementing the CfD regime. The CfD Counterparty will not be able to raise funds for any purposes other than paying the supplier obligation and meeting its own operational costs.

3.4.1.4 The Corporate Governance framework for the CfD Counterparty

348. Under UK company law, the Secretary of State as sole shareholder will have ultimate control over the counterparty. This is primarily through the ability to appoint and remove directors, amend the company's constitutional documents, and give shareholder instructions to the directors.
349. The composition of the Board will be guided by best corporate governance practice; it is currently anticipated the Board will comprise eight members, half of whom will be independent non-executive directors. It is also proposed that Board members would be appointed for three years and subject to re-election thereafter.
350. The Secretary of State will appoint a minority of the Board, likely to include the Chair, Senior Independent Director (SID) and a government shareholder representative. There will be a nominations sub-committee of the Board which will appoint the remaining Board members, including the CEO. As sole shareholder, the Secretary of State will have the power to veto any proposed appointments to the Board when they are recommended by the Nominations Committee but will not have any involvement in the recruitment process for the remaining Board.

3.4.1.5 The Constitutional Documents of the CfD Counterparty

351. The counterparty's constitutional documents will include Articles of Association, and as a company, the body will be subject to UK company law.
352. As with other Government owned companies the counterparty will also be subject to certain guidance relating to government-owned entities, including the fact that it will be governed by a Framework Document in line with HM Treasury's Managing Public Money guidance⁹⁵ in relation to arms' lengths bodies. This Framework Document will be made public and is proposed to set out, inter alia:
- the relationship between the CfD Counterparty and DECC as its sponsoring department,
 - the operating principles of the CfD Counterparty,
 - the extent of its day to day operational independence within certain parameters,
 - matters reserved for the Shareholder (including potentially in relation to contract controls);
 - certain controls relating to the CfD Counterparty's levy function;
 - the CfD Counterparty's management of ELEXON Ltd;
 - the CfD Counterparty's strategic priorities,
 - governance and accountability of the Board, including the Secretary of State's right to appoint a senior Government official to be the Secretary of State's representative on the Board;
 - management and financial responsibilities including budget setting;
 - remuneration limits that may apply;
 - the broader business planning processes and timetables; and
 - performance monitoring.

3.4.1.6 Arrangements for the Operational Establishment of the CFD counterparty

353. As set out in section 3.3 the counterparty's operational costs will be funded via a levy on suppliers. Government will fund the set up costs of the CfD Counterparty i.e. until the company is operational⁹⁶.

⁹⁵ https://www.gov.uk/government/uploads/system/uploads/attachment_data/file/212123/Managing_Public_Money_AA_v2_-_chapters_annex_web.pdf

⁹⁶ Some set up costs e.g. for settlement systems will continue to be incurred once the counterparty is operational, these will also be borne by Government.

- 354. Another important aspect of establishment of the counterparty is to decide where it will be located. Government policy is that no new leases should be signed when there is existing Government estate available, to avoid new charges to the taxpayer. We have undertaken an assessment of existing Government estate that would meet the counterparty’s space requirements ensuring that there are also the appropriate skills available in the locations available.
- 355. Following this assessment, the decision has been taken to locate the counterparty in London. It will be particularly important in the final stages of set up and initial operation that the counterparty is able to work closely with DECC and ELEXON Ltd (its designated settlement agent) to ensure that the counterparty is operational on time and implementation progresses smoothly. We believe this is best achieved by locating the counterparty within proximity to DECC. This will be reviewed in 3 years’ time in order to decide whether to locate outside London and South East within 5 years of operation.
- 356. The anticipated timetable for the setting up of the counterparty can be found in Figure 3.10 below:

Figure 3.10

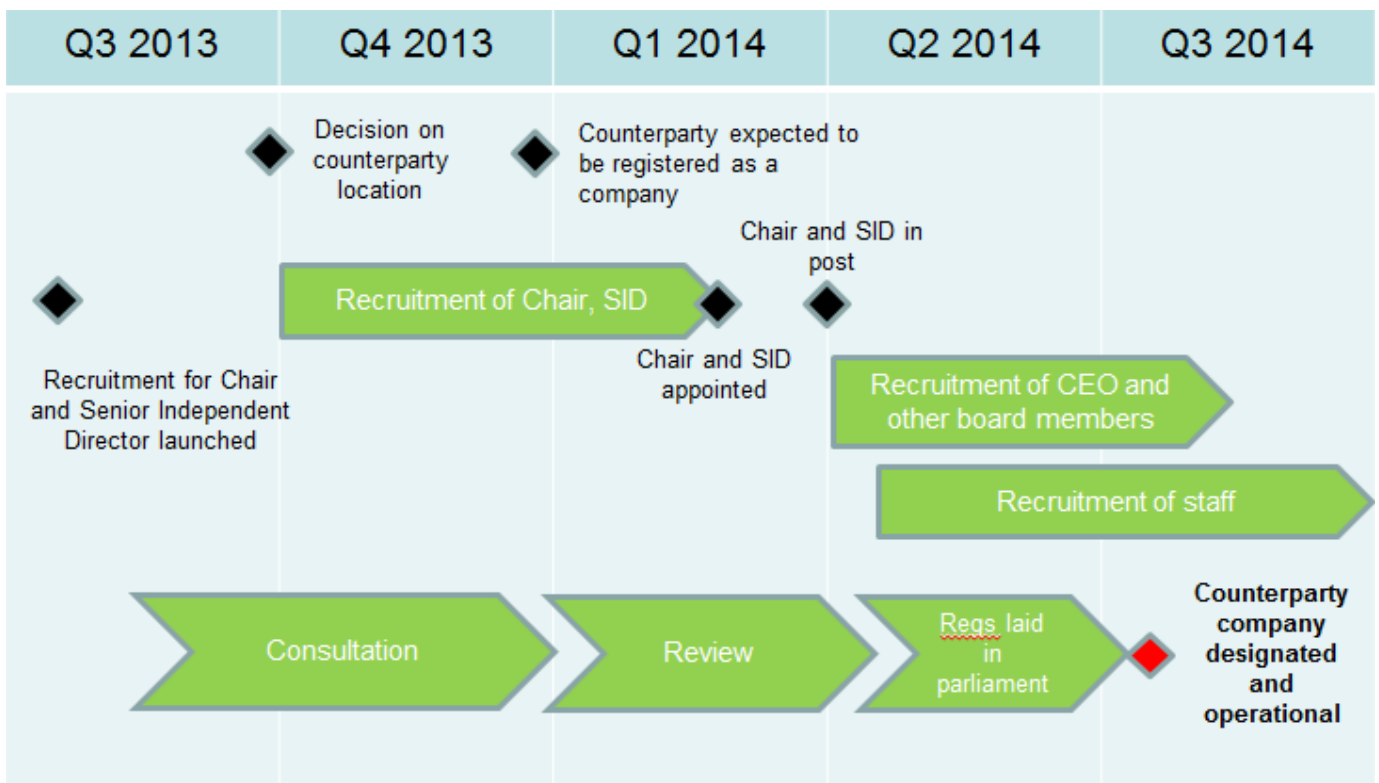

3.4.2 Designation of the CfD Settlement Agent

357. In November 2012 the Government stated that “*The Government ... is minded to use ELEXON as the settlement agent on behalf of the Counterparty*”. ELEXON Ltd (the Balancing and Settlement Code Company) currently administers the payment flows under the Balancing and Settlement Code (BSC). ELEXON Ltd is a not-for-profit body and the company is constituted through the Balancing and Settlement Code (BSC). The Government will also designate ELEXON Ltd as settlement agent for the Capacity Market. For more information see detail set out in Chapter 5.
358. The establishment of the BSC is a requirement of National Grid’s Transmission Licence as the System Operator. This ensures the independence of ELEXON Ltd from conflicts of interests and restricts the scope of its activities. ELEXON Ltd’s expertise and the fact that it already collects and processes the data that will be required for the Supplier Obligation puts it in a unique position in the electricity market to fulfil the role as settlement agent for EMR. ELEXON Ltd currently intends to establish a subsidiary company within ELEXON Ltd itself to deliver CfD settlement services.
359. Government will designate the Settlement Agent using powers to be granted to the Secretary of State by Clause 20 of the Energy Bill, to amend the National Grid Transmission Licence and the Balancing and Settlement Code (BSC).
360. We will publish proposed changes to the Transmission Licence and to the BSC and seek views from interest parties. Following this, the Government will lay the changes before Parliament and changes will come into effect in summer 2014.
361. ELEXON Ltd will be performing this role on behalf of the CfD Counterparty and so will be responsible to the CfD Counterparty for its performance. The cost of settlement services once payments have commenced will be borne by the CfD Counterparty and will be included in the CfD Counterparty’s annual budget.

3.4.3 Set-up of CfD Settlement Systems

362. ELEXON Ltd is funded by BSC Parties for the costs they incur in operating the trading arrangements of the BSC. Ahead of ELEXON Ltd’s designation as CfD Settlement Agent, there is a significant amount of preparation which ELEXON Ltd will need to undertake to be ready to delivery its new statutory duties. This includes the design, build and testing of the CfD settlement systems. Costs resulting from this activity will be met by Government, not BSC Parties.
363. In line with the approach followed under the BSC, ELEXON Ltd will tender for an external service provider to build and maintain the CfD settlement system. This service provider will also be responsible for the mechanical aspects of operating the system. This competitive procurement will ensure value for money for the IT system while the engagement of ELEXON Ltd will provide continuity to the industry through their role and expertise in delivering similar settlement services under the BSC. This procurement will take place over the autumn/winter 2013.

364. We are currently discussing the date on which generation will first be eligible for payments under CfDs or investment contracts and when supplier obligation payments should commence. Initial discussions with potential generators and consideration of the systems changes that will need to be put in place by both suppliers (for payment of the supplier obligation) and the CfD Counterparty and Settlement Agent suggest that payments may commence from April 2015. However, we will continue to discuss the implications of start dates for both potential generators and suppliers and will provide an update later this year.

Implementing the payment model

Question CFD53

Do you have views on any aspect of the proposals set out in this section 3.4?

Section 3.5: Next Steps

3.5.1 Developing Legislation

365. Responses to this consultation will form the basis for updating legislation early next year, and subject to parliamentary approval, implementing legislation should enter into force by the end of July 2014.

3.5.2 Devolved Administrations

366. We expect initial drafts of a CfD tailored for generators in Northern Ireland being available in Q4 2014. To achieve this Government and DETI will work with each other to seek to identify a means to enable the allocation principles being developed for GB to be applied to Northern Ireland, taking account of the particular factors that affect generators in Northern Ireland such as grid connection, planning permission and interaction with the Single Electricity Market (SEM). We envisage that the first payments under EMR for generators in Northern Ireland will flow from April 2016 with the first contracts for Northern Ireland being capable of being signed from late 2015. The supplier obligation will not, therefore, be levied in Northern Ireland until 2016.
367. We are currently consulting on a separate strike price for onshore wind located on the Scottish islands⁹⁷. Views should be fed in via the separate consultation running on this

⁹⁷ ,: <https://www.gov.uk/government/consultations/additional-support-for-scottish-island-renewables>]

subject, which is open until 30 October 2013. As announced in the draft delivery plan consultation, we propose that subject to the consultation, a differential strike price for these projects will be included in the in the final delivery plan.

Devolved Administrations	
Question CFD54	<ul style="list-style-type: none"> Given the different planning and grid connection regime in Northern Ireland, we would welcome views from Northern Ireland generators as to which point in the grid connection process in NI is most appropriate to sign a CfD.
Question CFD55	<ul style="list-style-type: none"> Are there any other issues in the allocation criteria that need to be amended for NI generators?

Section 3.6: Summary of Contract for Difference Design Proposals

Operational phase	Design area	Proposal
Phase 0: Budget Setting	How and when will the CfD budget be set?	<ul style="list-style-type: none"> The CfD budget parameters within the Levy Control Framework for each delivery year will be set by end 2013 and will be published in the EMR delivery plan (and again subsequently in the Allocation Technical Framework).
	When can the CfD budget be changed?	<ul style="list-style-type: none"> We do not expect the CfD budget to change frequently. However the scheme retains the flexibility to adjust the budget at Government's discretion. To provide certainty to generators, budget cannot be decreased for applicants within an allocation round, but can be increased at any time.
	What are minima and maxima? If Government chose to use this approach, how would these be set? Can they be changed, and how?	<ul style="list-style-type: none"> If used, minima would entail setting aside a portion of the CfD budget for a particular technology or group of technologies – for example, to give emerging technologies an opportunity to secure CfDs. If used, maxima would entail setting a cap on any allocation to a technology or group of technologies, above which no further allocation would be possible. These would be set at the same time as the CfD budget and would take into account the relevant technology's forecast level of deployment under all elements of the Levy Control Framework. As with overall budget decreases, changes to

		maxima or minima that were detrimental to any applicants would not be possible within an allocation round.
Phase 1: Application	When can I apply for a CfD?	<ul style="list-style-type: none"> The first applications for CfDs in England, Scotland and Wales may be submitted in late 2014. Once First Come First Served has ended and allocation rounds commence, there will be a fixed window within which all applications for a given round must be submitted.
	How do I apply for a CfD?	<ul style="list-style-type: none"> Submit an application, together with evidence against the eligibility criteria to National Grid. Details of the forms to use and where to address applications will be published in guidance from National Grid nearer the time..
	What do I need to include in the supply chain plan? When and how do I need to submit this?	<ul style="list-style-type: none"> We are currently working through what will be included in the Supply Chain plans and as stated in this document, the Government will issue a consultation on our detailed proposals in November. The November consultation will set out the information that a supply chain plan will need to include, as well as the criteria that they will be assessed against, and how each plan will be assessed. The outcome of this consultation will be a combination of regulations and detailed guidance for applicants.
	How can I appeal a decision on my eligibility for a CfD?	<ul style="list-style-type: none"> First submit an appeal in writing to National Grid, which will review the original decision for any errors. If the issue cannot be resolved, the second stage of appeal will be to Ofgem.
Phase 1: Allocation	What will the allocation process be?	<ul style="list-style-type: none"> We intend to initiate the scheme with a process of awarding contracts on a first come first serve basis. However, there may be some scenarios in which it may be necessary to begin allocation through the competitive process, for example, should demand exceed the available budget in the early years of the scheme. Once a significant amount of the budget for any given delivery year (perhaps 50%) has been used up, contracts will be allocated at set intervals through an allocation round.
	When will CfDs be allocated through a competitive process?	<ul style="list-style-type: none"> Should the maximum threshold for any particular technology be reached, or another budget constraint be triggered, contracts will be allocated through a competitive auction process.
	How can I appeal the outcome of an auction?	<ul style="list-style-type: none"> The same appeal process will apply as for eligibility (see above).
Phase 2:	When will the first CfD contracts be	<ul style="list-style-type: none"> The first contract under final investment decision enabling for renewables will be signed in early

Contract signature to commissioning	signed?	2014.
	What will the length of the contract be?	<ul style="list-style-type: none"> Contract length will be 15 years for renewable projects, apart from biomass conversion (for which all contracts will cease to pay in 2027) There will be flexibility for the Government to adjust contract length for projects where technology justifies a different duration (for example nuclear, CCS, tidal range and potentially large hydro projects).
	Under what circumstances can the terms of the CfD contract be varied?	<ul style="list-style-type: none"> The standard contract terms can be changed by Government in order to reflect a change in law, or to correct errors in the design that are subsequently identified once the scheme goes live. Changes to the terms of the standard contract would not apply retrospectively to existing contracts. Before the contract is signed, the generator can request minor or technical adjustments, in addition to the usual tailoring of the contract to project identifiers, to be negotiated with the counterparty. Once the contract has been signed, changes can only be made through the change control procedure set out in the contract or if mutually agreed between the counterparty and the Generator.
Phase 3: Payment	When will the supplier obligation begin to be levied?	<ul style="list-style-type: none"> We are currently discussing the date for which generation in GB will first be eligible for FIDeR and CfD payments and for supplier obligation payments to commence. Initial discussions with potential generators and consideration of the systems changes that will need to be put in place by both suppliers, and the counterparty and settlement agent suggest that payments may flow to generators from April 2015 with supplier obligation payments commencing shortly before. However, we will provide an update later this year.
	When will the first CfD payment be made in England, Scotland and Wales?	<ul style="list-style-type: none"> See above
	When will Northern Ireland suppliers start paying the supplier obligation?	<ul style="list-style-type: none"> It is envisaged the first CfDs will be eligible for signing for generators in Northern Ireland in April 2016. The supplier obligation will therefore not be levied in Northern Ireland until 2016, at which point Northern Ireland generators are capable of benefitting from the regime.

	How would payments from Generators to the Counterparty work, and in what circumstances would these be required?	<ul style="list-style-type: none"> Generators will be required to make payments to the Counterparty when the reference price is above the strike price. The counterparty will invoice generators for the difference payment and they will have five days to make these payments. The counterparty will pass any payments on to suppliers.
Institutional arrangements	Which organisations will implement and oversee Contracts for Difference?	<ul style="list-style-type: none"> CfDs will be put in place by the Secretary of State under the powers conferred by the Energy Bill. CfDs will be delivered by a combination of Government, National Grid (EMR delivery body), and counterparty. Ofgem will oversee delivery and we anticipate that they will have a role in appeals.
Geographic scope	What will be the geographic scope of the Capacity Market?	<ul style="list-style-type: none"> CfDs will apply first in England Wales and Scotland, with Northern Ireland coming onstream later on.

Section 4.3.1: Specific procedures for DSR participation in the enduring Capacity Market	193
4.3.1.1 DSR pre-qualification	193
4.3.1.2 Credit cover requirements for DSR	194
4.3.1.3 De-rating DSR	195
4.3.1.4 Testing DSR	196
4.3.1.5 Metering DSR	196
4.3.1.6 Baselineing DSR	198
Section 4.3.2: Transitional arrangements for DSR	200
4.3.2.1 Timing for DSR transitional arrangements	201
4.3.2.2 Eligibility for DSR transitional arrangements	201
4.3.2.3 Pre-qualification for DSR transitional arrangements	201
4.3.2.4 Products to be auctioned in the DSR transitional arrangements	203
4.3.2.5 Penalties and testing in the DSR transitional arrangements	203
4.3.2.6 Recovery of costs for the DSR transitional arrangements	203
4.3.2.7 Review of the DSR transitional arrangements	204
4.3.2.8 Stage 2 of the DSR transitional arrangements	204
Section 4.4: Payment model	206
Section 4.4.1: Payment model overview	206
Section 4.4.2: Calculating charges and payments	208
4.4.2.1 Capacity Market supplier charge	209
Section 4.4.3: Data systems and data collection	210
Section 4.4.4: Invoicing, banking and payment	211
4.4.4.1 Settlement body costs	212
4.4.4.2 Identification and Monitoring of credit cover	215
4.4.4.3 Requirements for credit cover	216
4.4.4.4 Default and mutualisation	216
Section 4.4.5: Settlement dispute resolution process	217
Section 4.4.6: Reconciliation	219
4.4.6.1 Role and governance of the settlement body	219
4.4.6.2 Governance and constitution of the Capacity Market settlement body	221
4.4.6.3 Role of the Capacity Market Settlement Agent	222
Section 4.5: Institutional and governance arrangements	225
Section 4.5.1: Institutional roles	225
4.5.1.1 The Government	225
4.5.1.2 Ofgem	225
4.5.1.3 National Grid	226
4.5.1.4 Capacity Market Settlement Body and Capacity Market Settlement Agent (Elexon)	226
4.5.1.5 Conflicts of interest	227
4.5.1.6 Confidentiality	227
Section 4.5.2: Devolved Administrations	228
Section 4.6: Legal Framework for the Capacity Market	230
Section 4.6.1: Legal Framework	230
4.6.1.1 Electricity Capacity Regulations and Capacity Market Rules	230
4.6.1.2 Consequential amendments to existing licences and industry documents	231
Section 4.6.2: Nature of a capacity agreement	232
4.6.2.1 Capacity agreement notice	232
4.6.2.2 Capacity Market register	233
4.6.2.3 Payment	233

4.6.2.4 Disputes and appeals	233
4.6.2.5 Force majeure	234
4.6.2.6 Change.....	234
4.6.2.7 Transfer	234
4.6.2.8 Termination and other remedies	234
Section 4.7: Ensuring the Capacity Market meets its objectives.....	239
Section 4.7.1: Ensuring sufficient investment	239
Section 4.7.2: Ensuring value for money for consumers.....	239
Section 4.7.3: Supporting the delivery of wider Government objectives.....	240
Section 4.7.4: Review and exit	241
Section 4.8: Capacity Market Units (CMUs) and pre-qualification requirements.....	244
Section 4.8.1: Capacity Market Units (CMUs)	244
Section 4.8.2: Pre-qualification requirements	247
Section 4.9: Summary of Capacity Market design proposals	251

Section 4.1: Introduction

367. The electricity market has delivered adequate security of supply in recent years but challenges facing the market mean it cannot be relied upon to do so in future. These challenges include the planned closure of a large proportion of our generating capacity and an increased amount of low carbon generation in the mix which means there is an increased need for additional reliable capacity, and market failures in the electricity market that deny investors the certainty needed for long term investments in generation infrastructure.
368. The Government has responded to these concerns by developing a Capacity Market as part of the Electricity Market Reform Programme.
369. The Capacity Market is intended to ensure sufficient investment in the overall level of reliable capacity (both supply and demand side) needed to provide secure electricity supplies. It will bring forward investment by allowing the market to competitively set a price for capacity. Capacity agreements will be offered to investors in existing and new capacity four years ahead of the year capacity must be delivered, giving them certainty over part of the future revenues they will receive. The Capacity Market will operate alongside the electricity market and the existing services National Grid contracts to ensure moment to moment balancing of the system.
370. National Grid will run the first auction in November 2014 for delivery of capacity from the winter of 2018/19, subject to the passage of the Energy Bill and state aid clearance.
371. In addition, the Government, Ofgem and National Grid are keeping the security of electricity supply situation under close review ahead of the introduction of the Capacity Market. Ofgem and National Grid ran informal consultations in June 2013 on the possibility of extending the balancing services already used by National Grid to balance the electricity system in order to secure additional capacity in the years ahead of the first Capacity Market delivery year. National Grid is intending to issue a further consultation in early October after which it will present any final proposals to Ofgem for approval.⁹⁸

Section 4.1.1 Scope of this chapter

372. This chapter sets out full proposals for the Capacity Market for consultation, along with the rationale for some of the more significant design choices. Because it provides an overview of the proposed mechanism in its entirety, it repeats some of the text of the Government's 27 June 2013 'Capacity Market: Detailed Design Proposals' document. It is structured as follows:

⁹⁸ Further information can be found at:

<http://www.ofgem.gov.uk/Markets/WhlMkts/effsystemops/Pages/effSystemOps.aspx>, and <http://www.nationalgrid.com/uk/Electricity/AdditionalMeasures>

- Section 4.2 explains the bulk of the Capacity Market policy, covering each area of design.
- Section 4.3 explains the proposals for ensuring the participation of demand side response capacity in more detail.
- Section 4.4 includes a more detailed description of the proposals for the Capacity Market payment model.
- Section 4.5 covers the institutional arrangements for delivering the Capacity Market.
- Section 4.6 describes the legal framework for the Capacity Market and the expected scope, content and legal basis of a capacity agreement.
- Section 4.7 explains how the Capacity Market has been designed to meet its objectives and includes proposals for its review.
- Section 4.8 includes more detail on the proposals for defining Capacity Market Units (CMUs) and criteria for pre-qualification.
- Section 4.9 summarises the overall design of the Capacity Market.

373. This chapter includes consultation questions on all aspects of the proposed design, and responses are invited by midnight on 24 December. Consultation questions are included in orange boxes, and blue boxes include information signposting the relevant sections of the accompanying draft implementing legislation.

374. This document does not include a detailed description of the security of supply outlook, the challenges facing the electricity market, or the need for a Capacity Market, which have been the subject of two previous consultations (in December 2010 and July 2011),⁹⁹ and will be covered in the Statutory Security of Supply Report (SSSR) published later this month. The SSSR will also include the Government's response to Ofgem's May 2013 Electricity Capacity Assessment. The impact assessment that will be published alongside the SSSR will provide the supporting analysis for the policy proposals that have been made for the design of the mechanism.

Section 4.1.2 Legal framework for the Capacity Market

375. The Energy Bill includes powers for the Secretary of State to introduce the Capacity Market. The draft legislation (set out in a combination of Electricity Capacity Regulations, Electricity Capacity (Payment) Regulations, and Capacity Market Rules) has been published for consultation alongside this document. Box 4.1 lists the draft instruments that will implement the Capacity Market. Section 4.6 describes the legal framework in more detail. Questions on the draft instruments are included in this chapter.

⁹⁹ December 2010: <https://www.gov.uk/government/consultations/electricity-market-reform>, July 2011: https://www.gov.uk/government/uploads/system/uploads/attachment_data/file/48131/2177-annex-c-emr-white-paper-consultation.pdf

Box 4.1: List of draft instruments that will implement the Capacity Market

- Electricity Capacity Regulations (referred to hereafter in this chapter as the regulations)
- Electricity Capacity (Payment) Regulations (referred to hereafter in this chapter as the payment regulations)
- Capacity Market Rules
- Consequential amendments to existing licences (to be consulted on in early 2014)
- Consequential amendments to existing industry codes (to be consulted on in early 2014)

Section 4.1.3 Roles and responsibilities for the Capacity Market

376. Figure 4.1 summarises the main roles and responsibilities in the Capacity Market.¹

Figure 4.1: Market participants

Market participant	Roles and responsibilities under the Capacity Market
The Government	<ul style="list-style-type: none"> • Oversight of policy effectiveness of the Capacity Market. • Will review the Capacity Market every five years, to consider the current and future roles of the Capacity Market, and whether it is still needed. • Makes an annual decision about whether a capacity auction is to be held and setting auction parameters. • Provides estimates and directions on the methodology to be used in producing the recommended demand curves and the assumptions to be used in preparing the electricity capacity report. • Determines the reliability standard.
National Grid (delivery body)	<ul style="list-style-type: none"> • Prepares and publishes an annual capacity report containing scenarios, estimates and/or recommendations. This report will also include demand and capacity contribution from electricity market participants ineligible for the Capacity Market to inform the target requirement in the demand curve. • Conducts analysis to support the Government's setting of some of the auction parameters. • Maintains a Capacity Market register. • Runs the pre-qualification process. • Calculates the range of de-rating factors from which a capacity provider selects their de-rating factor. • Publishes capacity auction guidelines before the

	<p>prequalification window opens.</p> <ul style="list-style-type: none"> • Notifies pre-qualification results to the Government. • Conducts the capacity auction or arranges for an auctioneer to do so. • Notifies auction results to the Government. • Notifies each bidder in the capacity auction whether or not its bid was successful. • Publishes the auction results. • Issues a capacity agreement notice to each capacity provider. • Issues Capacity Market warnings and delivery instructions.
Capacity Market Settlement Body	<ul style="list-style-type: none"> • Retains overall accountability and control of the Capacity Market settlement process. • Administers bank accounts used for managing the Capacity Market (holding bid-bonds, making payments, etc). • Contracts with the Capacity Market Settlement Agent. • Contract and performance manages the settlement agent. • Determines Capacity Market settlement disputes relating to the functions of the settlement agent. • Monitors and reviews the regulations relating to settlement functions of the Capacity Market and identifies and reports to the Secretary of State any recommended changes.
Capacity Market Settlement Agent	<ul style="list-style-type: none"> • Collects metering data on Capacity Market. • Sets up and maintains the systems that allow it to collect, securely store, and where appropriate securely transmit the data necessary for Capacity Market settlement. • Manages settlement of payments on the settlement body's behalf between generators and suppliers. • Calculates payments and charges. • Invoices, and collects payments due (as set out in the Capacity Market Rules and Regulations). • Enforces any non-payment of charges.
Ofgem	<ul style="list-style-type: none"> • Oversight and ownership of Capacity Market Rules. • Carries out a review every five years of those areas of the Capacity Market design that are covered in the Rules, looking at the effectiveness of the Capacity Market and whether existing code arrangements are fit for purpose. • Ensures that National Grid carries out its Capacity Market delivery duties efficiently, cost effectively and in a timely fashion. • May make changes to the Capacity Market Rules following consultation. • Provides the Government with an annual report on the operation of the Capacity Market; and National Grid's performance of its functions in relation to the Capacity Market. • Monitors conduct of participants in the Capacity Market to ensure consistency with competition requirements.

	<ul style="list-style-type: none"> • It is proposed that Ofgem will have a dispute resolution function in respect of certain decisions by National Grid in exercising Capacity Market functions.
(Potential) Capacity Provider	<ul style="list-style-type: none"> • Responsible for submitting the application to participate in an auction according to the eligibility criteria, requirements and processes as set out in the Rules. • Responsible for delivering their capacity obligation and complying with the terms of the capacity agreement.

377. Section 4.5 provides more detail on the roles involved in delivering the Capacity Market.

Section 4.2: Narrative of policy framework

378. The Capacity Market is designed to ensure sufficient investment in the reliable capacity needed to ensure security of supply during prolonged periods. It will do this by providing certain, regular payments to capacity providers, in return for which they must be available and producing energy (or reducing demand) when the system is tight, or face penalties.
379. The Capacity Market will operate alongside the electricity market – which is where most participants will continue to earn the majority of their revenues. There will also remain a need for National Grid to contract short term balancing services to ensure the moment to moment balancing of the system.

Figure 4.2: Key differences between the electricity, capacity and balancing services markets

Market	Role
Electricity market	<p><i>Generators sell electricity (£/MWh) to suppliers for particular periods of time</i></p> <ul style="list-style-type: none"> • Allows generators and suppliers to hedge price risk. • Provides signals for which plant/DSR providers should be dispatched and whether energy should flow in or out of GB through interconnectors.
Capacity Market	<p><i>National Grid will buy capacity (£/kW) on behalf of suppliers</i></p> <ul style="list-style-type: none"> • Will ensure sufficient investment to meet an enduring reliability standard by determining the level of plant retirements and new build through an auction four years ahead of each delivery year. • Will allow capacity providers to receive the share of their fixed costs not recoverable through the electricity market.
Ancillary (balancing) services market	<p><i>National Grid pays capacity providers (£/kW) for an option to buy energy at an agreed price (£/MWh)</i></p> <ul style="list-style-type: none"> • Ensures moment to moment balancing of the system. • Allows National Grid to have sufficient capacity in reserve so it can manage system at least cost to consumers. • Allow National Grid to procure 'system balancing' services not valued in the energy or capacity markets – i.e. <ul style="list-style-type: none"> ○ Capacity that is situated in particular locations; and/or ○ Capacity that is particularly flexible.

380. The Capacity Market can be described in six operational stages – each set out in turn in this chapter:
- a) **Amount of capacity (see Section 4.2.1):** where Ministers decide the amount of capacity for which capacity agreements are to be auctioned. This will be the total amount of capacity needed, with some deductions for capacity which will be on the system but which does not participate in the Capacity Market.
 - b) **Eligibility and pre-qualification (see Section 4.2.2):** where applicants eligible to offer capacity participate in a pre-qualification process run by National Grid.
 - c) **Auction (see Section 4.2.3):** where applicants who have successfully pre-qualified enter a competitive central auction also run by National Grid, four years (with a further auction one year) ahead of delivery. Successful bidders are awarded ‘capacity agreements’, which provide a steady payment for capacity in return for a commitment to deliver energy when required in the delivery year/s, or face a penalty.
 - d) **Secondary market (see Section 4.2.4):** where, between auction and delivery and in the delivery year/s, participants adjust their position through either financial or physical secondary trading, e.g. to take on a greater or lesser obligation, or if a new build that is facing delays to commissioning can find alternative capacity to meet the temporary shortfall.
 - e) **Delivery (see Section 4.2.5):** capacity providers receive payment if they provide capacity in the delivery year in periods of system stress. Financial penalties may apply if they do not deliver the amount of energy set out in their capacity agreement.
 - f) **Payment (see Section 4.2.6):** the costs of capacity agreements will be met by suppliers. The payments will flow from suppliers, via a settlement body, to providers of capacity. Where penalties are applied to capacity providers, the funds will flow from them, via the settlement body, to suppliers.
381. These stages are summarised in Figure 4.3. The following sections set out proposals for each of these operational stages in more detail.

Figure 4.3: Stages of Capacity Market operation

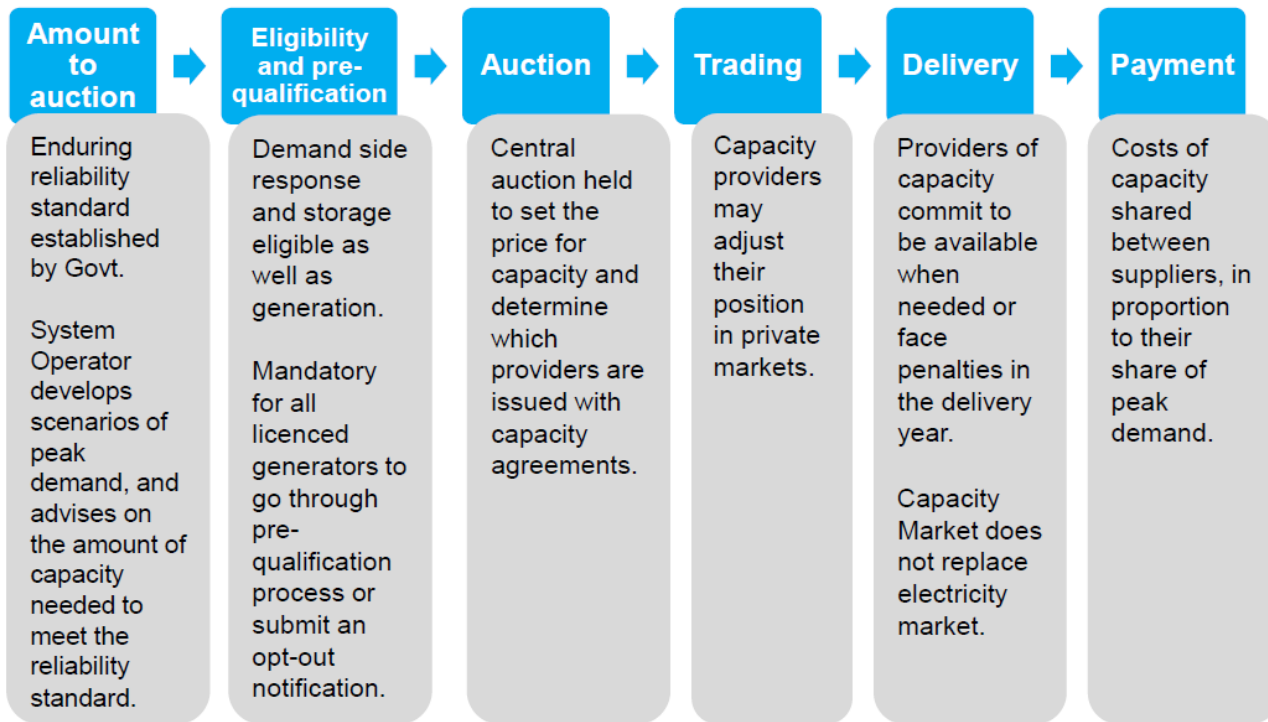

382. Government has been through a detailed process to develop this design, including:
- fortnightly meetings of a stakeholder expert group (which includes representatives from vertically integrated companies, independent generators, consumer groups, the demand side, Ofgem and National Grid);¹⁰⁰
 - engagement with other stakeholders including industry representatives;
 - discussions with various financial institutions and potential investors;
 - a detailed, open collaborative development process for working through the detailed steps required for delivery of the proposed mechanism with industry experts;¹⁰¹ and
 - advice from expert consultants who have been involved in Capacity Market design in other markets.

Section 4.2.1: Amount to auction

383. This sub-section covers the process for establishing the amount of capacity to auction in the Capacity Market.

Figure 4.4: Amount to auction

¹⁰⁰ For more information on the Capacity Market Expert Group please visit: <https://www.gov.uk/government/policy-advisory-groups/capacity-market-emr-expert-group>

¹⁰¹ For more information on EMR's collaborative development processes, and materials made available for meetings, please see <https://www.gov.uk/government/policy-advisory-groups/electricity-market-reform-emr-collaborative-development>

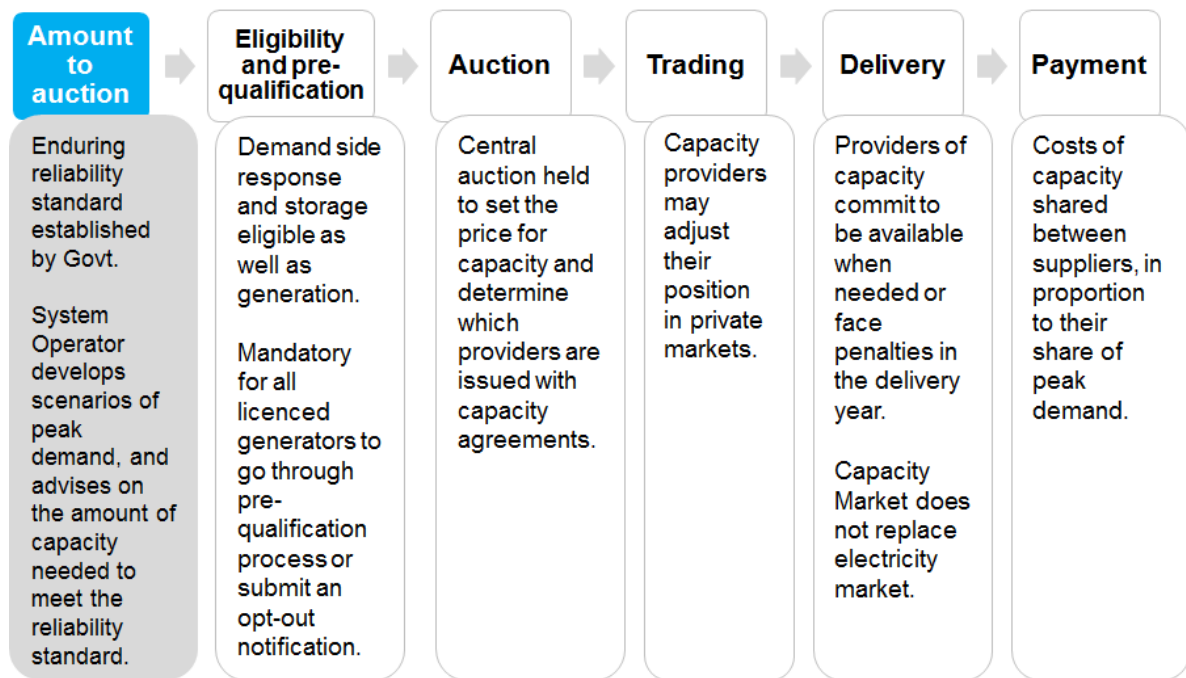

Summary of proposals:

- The enduring reliability standard will be established in December 2013 in the first EMR delivery plan.¹⁰²
- Annual security of supply analysis on the amount of capacity required to meet the reliability standard will be carried out by National Grid and scrutinised by the independent panel of technical experts.¹⁰³
- A capacity demand curve will be determined annually by the Government, in advance of capacity auctions. The demand curve will:
 - set a target level of capacity to auction;
 - enable the trade-off between cost and reliability to be automatically determined at auction; and
 - set a cap on the maximum price that can be set at auction.
- The contribution to security of supply of any ineligible capacity (including interconnected capacity), and plants that opt out of the auction, will be taken into account when setting the total amount of capacity for which capacity agreements are to be issued.

¹⁰² Government consulted on a draft reliability standard in the draft delivery plan: <https://www.gov.uk/government/consultations/consultation-on-the-draft-electricity-market-reform-delivery>

¹⁰³ Following Royal Assent of the 2012 Energy Bill, the EMR panel of technical experts will be appointed by Government as an *ad-hoc* advisory group. Further detail on their role can be found in Annex E of the November 2012 EMR Policy Overview: <https://www.gov.uk/government/publications/electricity-market-reform-policy-overview--2>. An interim panel has been appointed to scrutinise the analysis being done for the first EMR delivery plan. Further detail on the interim panel is available at <https://www.gov.uk/government/policy-advisory-groups/141>

4.2.1.1 Reliability Standard

384. To increase long term investor certainty, the Secretary of State will establish and publish an enduring reliability standard. A reliability standard will provide an indication of the acceptable level of security of supply for the GB system – bearing in mind the likely costs of providing that level of security. We anticipate that this will be expressed as a loss of load expectation (LOLE).¹⁰⁴
385. Setting the standard on an enduring basis is intended to minimise the risk of over procurement of GB capacity, and avoid large swings in the amount auctioned from one year to the next – which would increase uncertainty for investors, and therefore the risk premium applied in their bids. As a result bids would be higher, unnecessarily increasing costs for consumers. While it is envisaged that the reliability standard will be set on an enduring basis, there will be an opportunity for the Government to review it should it prove necessary.
386. The Government consulted on a draft reliability standard in the draft EMR delivery plan in July 2013, and intends to finalise the reliability standard in the first EMR delivery plan to be published in December 2013.

4.2.1.2 Demand curves

387. In the first EMR delivery plan in advance of the first auction, the Government will publish a methodology for calculating the demand curves for capacity auctions. Demand curves are important since they allow a trade-off to be made between reliability and cost (e.g. analysis might suggest that 45 gigawatts (GW) is the ideal amount of capacity but if the 45th GW is very expensive, entering into capacity agreements for only 44GW might be better value). Demand curves also help mitigate gaming because they provide an auction price cap, and flexibility to procure less capacity if the price is high – both of which reduce opportunities for participants to attempt to push up prices by exercising market power.
388. The Government's intention is to hold a main auction for pre-qualified capacity every year, for delivery in four years' time. A further year-ahead auction will be held in the year immediately prior to the delivery year of the main auction. The frequency of auctions is explained in more detail in Section 4.2.3.
389. The Government will publish the demand curve for each four year ahead auction around four and a half years ahead of the delivery year, and the demand curve for each year ahead auction around one and a half years ahead of the delivery year.

¹⁰⁴ i.e. the number of hours/periods per annum in which, over the long-term, it is statistically expected that supply will not meet demand, and which reflects the economically efficient level of capacity. This does not mean that we would have this level of blackouts in a particular year; in the vast majority of cases, loss of load would be managed without significant impacts on consumers.

390. Each demand curve will be constructed around a target capacity level and an estimate of the reasonable cost of new capacity (the net cost of new entry, or 'net-CONE'). The intersection of these points sets the price at which National Grid will demand the amount of capacity required to meet the reliability standard established by the Government.

Figure 4.5: Illustrative capacity demand curve

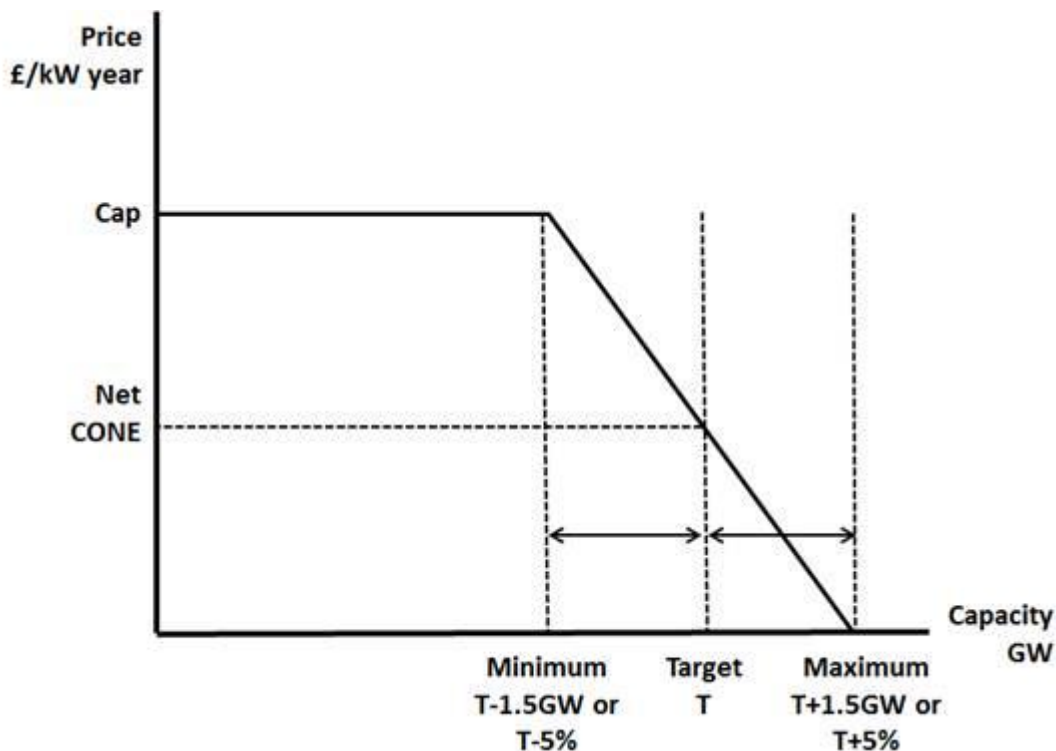

391. The target capacity level will be informed by analysis from National Grid on the amount of capacity required to meet the reliability standard, and will take into account the level of capacity expected to be available outside the Capacity Market (e.g. capacity supported by Contracts for Difference (CfDs), and expected imports via interconnectors). Demand curves will be revised downwards when pre-qualification concludes so less capacity is auctioned if plants have opted out of participating in the mechanism but have indicated they will remain operational during the delivery year.

4.2.1.3 Auction price cap

392. The auction price cap determines the top of the demand curve – i.e. the price at which no more capacity will be auctioned.
393. The purpose of a price cap is to protect consumers from unforeseen problems with the auction, such as a lack of competition or abuse of market power by participants. However, setting the auction price cap too low could put off bidders and reduce competition, so it is important that the price cap is set at a level that encourages competition in the capacity

auction, and allows the market to set an efficient price for new capacity based on participants' judgement of the risks and potential returns in the electricity and capacity markets. Getting the level of the price cap right depends on an assessment of the degree of uncertainty around the central estimate of net-CONE.

394. Net-CONE has been determined from the cost of a new build open cycle gas turbine (OCGT) plant (i.e. gross-CONE) minus expected electricity market revenue, and will be revised if necessary for each auction, for instance based on new engineering cost estimates for new build and on information gained in previous auctions.¹⁰⁵
395. The draft delivery plan consulted on an estimate of gross-CONE (i.e. the cost of new entry before taking account of expected electricity market revenues) of £47/kW per year. Based on an expectation that capacity providers should earn £18/kW year from the electricity market given a reliability standard of 3 hours of lost load per year and Ofgem's proposal, as part of its cash out reform process, for a £6,000/MWh scarcity price signal. The Government estimates net-CONE to be £29/kW per year in 2013 prices.¹⁰⁶
396. Some industry participants have raised concerns about the proposed net-CONE being too low for a range of reasons:
- Parties may not put a high value on the potential electricity market scarcity revenues or capacity payments beyond the original capacity agreement term given that these are uncertain.
 - Parties may require a risk premium to compensate them for the risk of penalties they would be holding by taking on capacity obligations, particularly as participants do not yet know to what extent a liquid secondary market will develop for parties to hedge their risk of penalties at times when they do not expect to be operational.
 - There are currently no consented large-scale OCGT projects that can participate in the first auction. This means the new entry price might be set by a combined cycle gas turbine (CCGT) or smaller OCGT which could have higher costs.
 - Existing plants may seek higher revenue in the first auction so it is profitable to remain available until the first delivery year four years hence in 2018/19.
397. However, the Government recognises that there is uncertainty around the estimates of net-CONE – for instance the financing costs and payback periods for new plants, as well as uncertainty about which technology will set the cost of new entry in the auction. Given this uncertainty, the Government is seeking views on two options for setting the auction price cap.

¹⁰⁵ The cost of OCGT capacity is used to set CONE as this is expected to be the marginal plant i.e. the one that most needs a capacity payment (because it runs least) and should therefore be setting the price in the auction.

¹⁰⁶ For more information on Ofgem's proposals please visit: <https://www.ofgem.gov.uk/electricity/wholesale-market/market-efficiency-review-and-reform/electricity-balancing-significant-code-review>

Option 1: auction price cap set at a multiple of net-CONE

398. The first option is to set a price cap based on a multiple of the estimated net cost of new entry (net-CONE). Using a multiple of 150% and based on the estimates consulted on in the delivery plan, would provide a cap level of £44/kW. A multiple of 150% is consistent with international capacity markets and would allow for a range of uncertainties to be reflected in auction bids.

Option 2: administratively set a higher price cap

399. The second option involves setting an administrative price cap at a higher level to ensure there are opportunities for a wider range of projects / technologies to set the price and ensure that the auction clears. Under this option the Government would set a price cap of around £75/kW year. This would allow for the auction to clear up to 25% higher than the estimated bid of a new CCGT in a scenario where parties do not take full account of potential scarcity rents in the electricity market.¹⁰⁷

Box 4.2: Indexation of payments

- Capacity payments will be indexed for inflation from the beginning of the delivery year onwards according to the Consumer Prices Index.
- It is proposed that participants will hold inflation risk between the auction and the delivery year. This is because all participants will hold the same price risk between the auction and delivery year and so indexing payments between the auction and the delivery year is not necessary to ensure a level playing field between parties taking on different agreement lengths.
- However given that auction participants will hold price risk between the auction and the delivery year, it will be necessary to adjust the auction parameters to account for anticipated inflation. For instance, if inflation were expected to be 2% per year, then net-CONE at the four year ahead auction would be increased by 8.2% over estimates in current prices.

400. Given uncertainty around estimates of net-CONE, the outcome of the auction could provide evidence for how net-CONE should be set in subsequent auctions. It is therefore proposed that net-CONE should be revised for following auctions according to the information obtained from the first auction. The price cap could then be set at a multiple of that estimation of net-CONE.

¹⁰⁷ Further detail on the determination of the auction parameters will be set out in the Capacity Market Impact Assessment, which will be published later this month.

4.2.1.4 Constructing the slope of the demand curves

401. The slope of each demand curve (between the points set by the target level of capacity and the auction price cap) identifies how the amount auctioned will differ according to the price at which capacity is available.
402. For the main, four year ahead auctions, the Government proposes to set the slope so that capacity agreements totalling a level of de-rated capacity within 1.5GW of the target are auctioned. 1.5GW approximately represents the de-rated capacity of two large CCGT plants. Allowing the amount of capacity contracted in the auction to vary by this amount either side of the target should ensure that no single plant can significantly influence the auction clearing price.
403. For the year ahead auctions, the Government proposes to calibrate the demand curve differently so that the maximum amount of capacity demanded is 5% above the target level (rather than 1.5GW above the target level). And the demand curve will become horizontal (i.e. the price is $1.5 \times \text{net-CONe}$) at 5% below the target level of capacity.
404. Setting a tolerance level of 5% above or below the target volume of capacity provides an equivalent level of slope to the demand curve for the four year ahead auction (where there is a 1.5GW tolerance level around that target volume). The 5% tolerance level helps to mitigate gaming risk in the year ahead auction and ensures less capacity is procured if it is higher cost and so poorer value for money.

4.2.1.5 Electricity capacity adequacy assessment

405. National Grid will provide an annual electricity capacity report containing an assessment of the amount of capacity that is needed for a delivery year (running from 1 October to 30 September) to meet the reliability standard based on an assessment of different possible scenarios.
406. Section 47ZA of the Electricity Act 1989 obliges Ofgem to provide the Secretary of State for Energy and Climate Change with a report assessing demand for, and supply of, electricity in Great Britain, including an assessment of the different possible capacity margins for that supply and the degree of protection that each scenario would provide against the risk of shortfalls in supply.¹⁰⁸ Section 172 of the Energy Act 2004 obliges the Secretary of State to make and lay before Parliament an assessment of the amount of capacity needed to ensure security of supply.

¹⁰⁸ Section 47ZA was inserted by the Energy Act 2011.

407. The Government is proposing – through the forthcoming Energy Act – to remove the obligation on Ofgem to provide its annual Electricity Capacity Assessment report. To administer the Capacity Market, the Government will require annual advice on the amount of capacity needed to meet the reliability standard. Since National Grid will be the delivery body for the Capacity Market, and it has considerable expertise in this area, it makes sense for National Grid to provide this advice to the Government, starting from 2014. As such, the Government is proposing to remove the obligation on Ofgem to provide this assessment. The timing of this change will be confirmed at a later date. To provide the Government with additional assurance on the robustness of the advice from National Grid, an independent panel of technical experts will comment on the assumptions to be used in the analysis, scrutinise the modelling approach and review the models chosen for the analysis.

Box 4.3: Most relevant sections of the draft instruments that relate to this sub-section

Regulations:

- Part 2: Reliability standard
- Part 3: Electricity capacity report
- Part 4: Capacity auctions
 - i. Chapter 1: Determining whether capacity auction to be held
 - ii. Chapter 2: Auction parameters

Box 4.5: Consultation questions:

Amount to auction

Question CM01	<ul style="list-style-type: none"> • What are your views on the proposed delivery year (1 October to 30 September)?
Question CM02	<ul style="list-style-type: none"> • What are your views on the proposed approach for setting the amount to contract in each Capacity Market auction?
Question CM03	<ul style="list-style-type: none"> • Do you think the proposed value for net-CONE (£29/kW per year) and the proposed auction price cap (1.5 * net-CONE) are appropriate for the first auction? If not, do you think that the proposal for a transitional price cap of around £75/kW is appropriate to allow for a wider range of projects to set the price in the first auction(s)?
Question CM04	<ul style="list-style-type: none"> • Do you think that the price of new entrant bids in the auction should inform the net-CONE set in subsequent auctions?
Question CM05	<ul style="list-style-type: none"> • What are your views on the proposed approach to indexing capacity payments and penalties?

Question CM06	<ul style="list-style-type: none"> Do you have any further comments on aspects of the design described in this sub-section?
Question CM07	<ul style="list-style-type: none"> Do you have any comments on Parts 2 and 3, and Chapters 1 and 2 in Part 4 of the regulations for implementing proposals for setting the amount of capacity to auction?

Section 4.2.2: Eligibility and pre-qualification

408. This sub-section explains the types and amounts of capacity that will be eligible to participate in capacity auctions and receive capacity payments, and the process for pre-qualifying capacity in advance of auctions.

Figure 4.6: Eligibility and pre-qualification

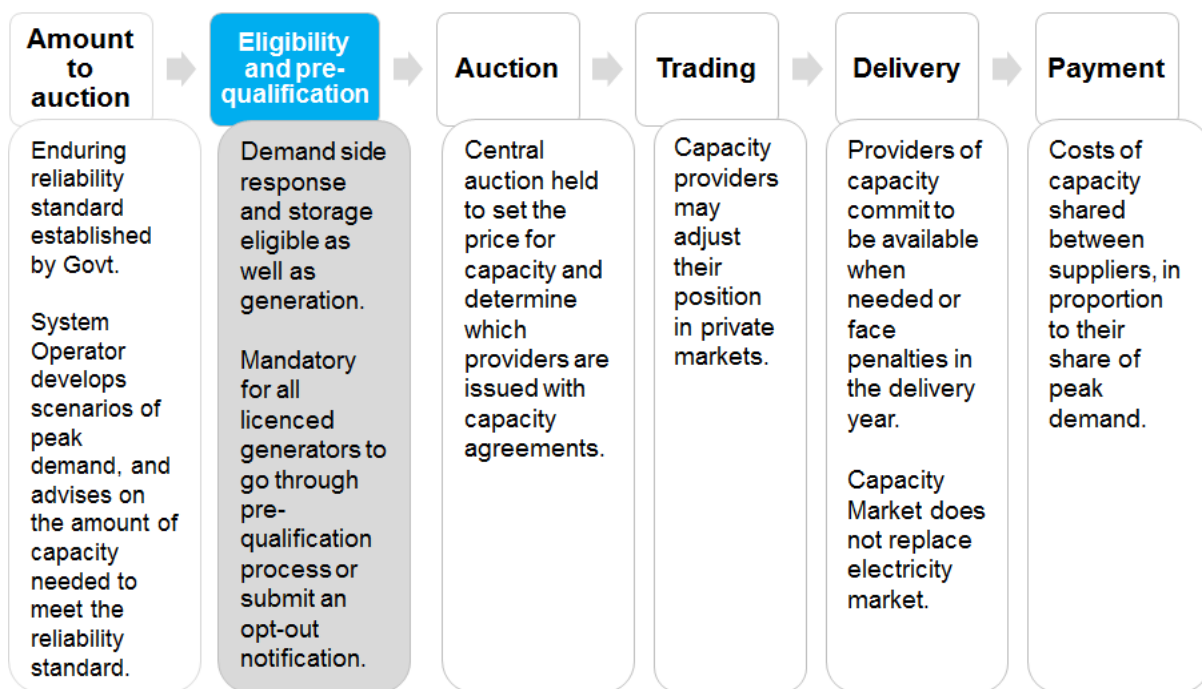

Summary of proposals:

- The following will be eligible to participate in the Capacity Market:
 - New and existing generation capacity (including combined heat and power (CHP)).
 - Demand Side Response (DSR), including embedded generation.
 - Electricity storage.
 - Permanent reductions in electricity demand (EDR) could also be able to participate in future. The Government has amended the Energy Bill to enable this and is planning to pilot the approach before final decisions on EDR are

made.

- The following forms of capacity will not be eligible to participate in the Capacity Market:
 - Capacity receiving support through the Renewables Obligation (RO), Contracts for Difference (CfDs), small scale Feed in Tariffs (FIT), renewable heat incentive (RHI), new entrants reserve 300 (NER300), or UK carbon capture and storage commercialisation programme.
 - Interconnected non-GB capacity, and the interconnectors themselves (though the Government is continuing work to explore potential solutions that might enable the participation of interconnected capacity in future auctions).
- Capacity below a 2 megawatt (MW) *de-minimis* threshold will only be able to participate when combined with other capacity through an aggregation service.
- All eligible capacity will be free to participate in both the Capacity Market and Balancing Services markets.
- Though participation in capacity auctions will be voluntary, licenced generators must for each of their eligible plants either apply to pre-qualify or, if they do not wish to bid in the capacity auction, submit an opt-out notification. The opt-out notification must state whether the generator intends to run the plant during the delivery year and, if not, whether it is retiring the plant or closing it temporarily. The pre-qualification stage is also mandatory for other applicants who intend to bid (e.g. DSR providers). This stage is to confirm the eligibility and bidding status of potential capacity providers.
- The amount of capacity each participant can bid into the auction will be determined by National Grid (subject to rules on the de-rating factor to be applied).¹⁰⁹
- There will be a dispute process for participants unhappy with National Grid's assessment of their pre-qualification eligibility.
- Specific rules will apply for pre-qualifying, de-rating, metering and baselining DSR capacity.

409. The Capacity Market has been designed to be technology neutral – that is, the Government is not seeking to procure specific volumes of different types of capacity, and all types of capacity are able to participate, with some limited exceptions.
410. Generation, including combined heat and power (CHP) capacity, will be able to participate, as will storage and demand side response (DSR).
411. Existing and new plants will be eligible to participate in the Capacity Market. Existing plants should receive a capacity payment because consumers will benefit from keeping existing plants on the system where it is cost effective to do so.
412. Small scale capacity below a 2MW *de-minimis* threshold will not be eligible unless combined with other capacity through an aggregation service.

¹⁰⁹ De-rating refers to the process by which we will determine the amount of reliable capacity that can be ascribed to each potential Capacity Market resource. Government's proposed approach to this is set under 'Pre-qualification' below.

413. Capacity providers will participate in the Capacity Market on the basis of 'Capacity Market Units' (CMUs). Section 4.8 explains the proposals for defining CMUs in more detail.
414. In the capacity auction, the Government expects that plants will only be compared on the level of their auction bids and there will be no requirement for particular plant characteristics.
415. Participation in the Capacity Market is not mandatory, although it is proposed that it will be mandatory for existing capacity to participate in the prequalification process.

Box 4.6: Rules for plants wishing to opt out of the Capacity Market

- As part of pre-qualification, existing capacity will be able to opt out of participating in the capacity auction. Providers choosing to opt out must then select from one of the following three categories:
 - Opt out plants that expect to be operational for that delivery year;
 - Non-operational opt out plants that expect to be closed down or decommissioned by the start of the delivery year; or
 - Non-operational opt out plants that expect to be temporarily non-operational for that delivery year but operational for subsequent delivery years.
- The amount auctioned will be reduced by the capacity of plants opting out but that has declared it will be operational in the delivery year, although to a derating level that is slightly lower than for plant that opts in to the mechanism. This lower derating is set at two standard deviations below the average capacity credit for a given technology group. However where opt-out capacity declares that it will be non-operational in the delivery year then demand in the auction will not be reduced by an equivalent amount.
- Any eligible capacity that opts out of the capacity auction will not be exposed to Capacity Market penalties for non-delivery, nor will they be eligible for any payment for over delivery (see Section 4.2.5) or take on obligations in the secondary market.
- Operational opt-out capacity will be able to opt back into all subsequent auctions and can then participate in the secondary market if they are not successful in that auction.
- However capacity that had declared itself *temporarily* non operational will be eligible to enter capacity auctions for subsequent delivery years but not in the year-ahead auction for that delivery year; and capacity that had declared itself *permanently* non operational will be ineligible to enter the year-ahead auction for that delivery year or in the auctions for the two subsequent delivery years. These restrictions are put in place to mitigate incentives on existing plant to withhold capacity from the auction,

and to give strong incentives to parties to opt in to the mechanism.

4.2.2.1 Demand side response (DSR)

416. The Government is committed to ensuring that DSR (including embedded generation and smaller storage) is able to participate in the Capacity Market. We propose to:
- run one year ahead auctions, as well as four year ahead auctions, allowing DSR that finds it difficult to commit to providing capacity four years ahead of delivery to participate (though year ahead auctions are in any case valuable for fine tuning the amount of capacity holding capacity agreements to reflect changes in demand projections between the four year ahead auction and the delivery year); and
 - put in place transitional arrangements for DSR in advance of the first year ahead auction. These will help to increase the total amount of DSR on the system and ensure that we fully exploit DSR capabilities.
417. Both the transitional arrangements and the procedures for DSR participation in the main Capacity Market are described in more detail in Section 4.3.

4.2.2.2 Electricity storage

418. Smaller electricity storage (i.e. storage connected to the distribution rather than the transmission network and under 50MW) will benefit from the transitional DSR arrangements laid out in Section 4.3.
419. All storage will be able to participate in the Capacity Market and can choose whether to enter in the four year or year ahead auctions. Storage will be able to aggregate with other resources to bid into capacity auctions in the transitional arrangements and main Capacity Market and can participate in the secondary market. This will help mitigate the risk storage faces of only being able to respond for a limited duration during a stress event.
420. Storage will be able to demonstrate delivery of capacity by exporting stored electricity to the grid. In addition, although provisions for this are not included in the draft rules published alongside this document for consultation, it is intended that storage would be eligible for over delivery payments by stopping importing (if it would usually be importing at the time of a test or system stress event) using an 'X of Y' baseline (this baselining method is explained in Section 4.4). This would allow over delivery payments (see Section 4.2.5) to be made where the unit would usually be importing at that time. These times are most likely to occur off-peak when stress events are less likely so it is not intended that storage will be able to obtain a capacity agreement for their ability to stop taking load, only for their generating capacity.

4.2.2.3 Electricity Demand Reduction

421. Action on the demand side is a key part of the Government's reforms – both for DSR and permanent reductions in demand. DECC launched a consultation in November 2012 on

whether and how to incentivise permanent electricity demand reduction (EDR), including whether EDR should participate within the Capacity Market. The Government's response to this consultation, published on 22 May 2013, confirmed the Capacity Market as the Government's preferred route to deliver a financial incentive for EDR and explained the rationale for this decision.¹¹⁰

422. However, before proceeding, the Government is planning to test the proposed approach via a pilot. The Government has confirmed that at least £20m will be made available for the pilot which will enable us to better understand how efficient and cost-effective financial incentives for EDR are and examine how EDR measures can best participate in the Capacity Market. It will also allow us to test and develop some of the more detailed aspects of design to inform the final scheme.
423. The Government expects the pilot to start in summer 2014 and to run for two years. A decision on financial support for EDR going forward will be made based on what we learn from the pilot.
424. The development of secondary legislation to enable the inclusion of EDR in future capacity auctions will be conditional on the outcome of the pilot. EDR will not be eligible to participate in the 2014 capacity auction. The draft secondary legislation published for consultation alongside this document does not therefore include provisions for EDR participation. Further information on EDR can be found in Annex D.

4.2.2.4 Low carbon capacity

425. The Capacity Market is intended to be a technology-neutral mechanism in which all types of capacity are able to participate. However, to avoid overcompensation, it is proposed that there will be restrictions on the participation of low carbon capacity where it is already in receipt of other forms of support.
426. Plants receiving CfDs will not be eligible to participate in the Capacity Market, at least while levels of support for Contracts for Difference (CfDs) are set administratively.
427. Consistent with this principle, capacity that is fitted with Carbon Capture and Storage (CCS) and in receipt of a CfD will not be eligible to participate in the Capacity Market (regardless of whether the capacity runs in unabated mode at certain times during a delivery year). This will include circumstances where capacity is increased temporarily to respond to peaks in

¹¹⁰ Consultation document and Government response available at:
<https://www.gov.uk/government/consultations/options-to-encourage-permanent-reductions-in-electricity-use-electricity-demand-reduction>

demand. CCS capacity not in receipt of a CfD, or unabated units within a partly abated power station, will be eligible to participate in the Capacity Market.

428. Similarly, capacity receiving support through either the Renewables Obligation (RO) or small scale Feed in Tariffs (FIT) will be ineligible to participate in the Capacity Market. Such capacity will be eligible to enter the Capacity Market once their RO or FIT support has expired provided they meet all other eligibility criteria (such as minimum size). However, with the exception of biomass co-firing plants, RO-accredited plants will not be eligible to terminate their 20-year term of RO support early in order to bid in to the Capacity Market.
429. In addition, plants claiming the Renewable Heat Incentive (RHI) will be excluded from the Capacity Market. Renewable combined heat and power (CHP) plants will be able to claim the RHI on renewable heat generated and the RO or CfD on renewable electricity generated, and these schemes represent the best way of supporting renewable CHP plants.
430. Finally, plants that receive funding from the New Entrants Reserve 300 (NER 300)¹¹¹ or from the UK CCS Commercialisation Programme will be excluded from the Capacity Market for ten years following the start of the period of support (and will be subject to the eligibility rules for other forms of low carbon support should they claim additional support through another scheme like the CfD).¹¹²
431. These exclusions aim to avoid any risk of double payment, and will have a minimal impact on future low carbon investment as the levels of support offered for low carbon investment through other schemes should be robust to the introduction of a Capacity Market.
432. To verify that plants opting in to the Capacity Market are not in receipt of low carbon support, we propose a two stage process whereby plant opting in to the Capacity Market will be required to self certify whether they are eligible for low carbon support; and those that are eligible will be required to provide confirmation from Ofgem and the counterparty that they are not receiving support. Further details are provided in the prequalification section.

4.2.2.5 Balancing services

433. Balancing Services describe the range of services that the National Grid procures and uses in order to coordinate and direct the flow of electricity onto and over the national electricity transmission system in an economic, efficient and coordinated manner. There will still be a need for these balancing services after the Capacity Market has come into effect. If a provider believes it can offer both capacity and balancing services then it can participate in

¹¹¹ The NER 300 is a low carbon energy fund administered by the European Commission. It provides funding for nascent low carbon technologies, and applicants can opt to receive the funding in the form of a capital grant or an operating grant spread over a maximum period of ten years.

¹¹² More information on the UK CCS Commercialisation Programme is available at <https://www.gov.uk/uk-carbon-capture-and-storage-government-funding-and-support>

the Capacity Market and Balancing Services markets, and if successful in both could receive revenue from both. However, in this situation a provider will have to meet the requirements of both, and will face penalties under its balancing services contracts and under the Capacity Market if failing to act as instructed for balancing services at a time of scarcity when Capacity Market penalties also apply.

434. Adjustments to a capacity provider's capacity obligation will be made to account for the interactions with the provision of balancing services to National Grid such that it is not unfairly penalised for acting in accordance with National Grid's instructions under a balancing services contract. For instance if a generating unit is providing a frequency response service under a balancing services agreement and as a result of this it is required to operate at an operating level 200MW below its full capability then any capacity obligation would also be lowered by 200MW to reflect the action of the balancing services agreement.

4.2.2.6 Interconnected capacity

435. The Government is keen to find a way for interconnected capacity to be able to participate in the Capacity Market. Participation of interconnected capacity would increase efficiency by increasing competition in the auction, and provide appropriate incentives for additional investment in interconnection. Any solution must preserve the integrity of the Capacity Market itself, and be compatible with European internal energy market rules since completion of the internal energy market offers clear benefits and is an important priority for the Government.
436. This is a complex area and we have worked closely with expert stakeholders, other EU Member States and the European Commission to explore possible solutions. However despite this work we have been unable to find a solution that the Government believes offers a practical solution for the first capacity auction in November 2014. We continue to work on this issue however and aspire to finding a solution that is capable of being implemented at the earliest in time to compete in the 2015 capacity auction.
437. The Government is seeking a solution that meets the following key objectives:
- a. where possible capacity procured from non-GB sources must physically deliver electricity to the GB system at times of system stress;
 - b. where there is no physical delivery of its electricity to the GB system at times of system stress, penalties equivalent to those faced by GB capacity should be imposed; and
 - c. the solution must be compatible with the EU Target Model and third package requirements, and maximise compatibility with the internal energy market.
438. It may be possible to implement a model where a party or parties take on equivalent obligations to a GB capacity provider but in relation to capacity provided by an interconnector. This capacity would have to be delivered to GB at times of system stress,

with delivery being referenced against transfers of energy across the interconnector to Great Britain so that if 1000MW of capacity is sold across an interconnector, Capacity Market penalties would be applied to the provider(s) of such capacity should the interconnector supply less than 1000MW of electrical power to GB throughout any stress event. An initial proposal is described in Figure 4.7 below. Views are welcome on the potential for a solution along these lines to be developed, or on alternative solutions that might meet the requirements above.

Figure 4.7: Potential high level proposal for allowing the participation of interconnected capacity in the Capacity Market

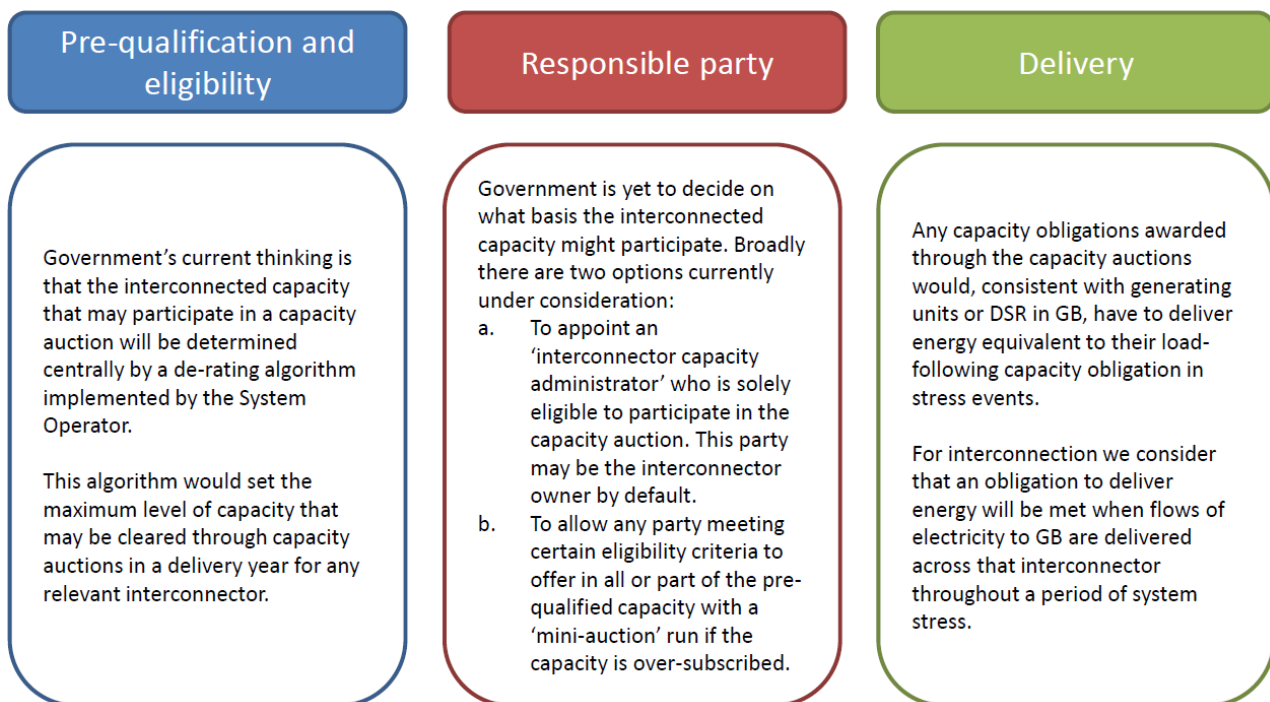

439. In related electricity interconnection policy and regulatory developments, Ofgem will publish early next year final details of the new cap and floor regulatory regime for application to project NEMO, the proposed interconnector between GB and Belgium.
440. Under this approach, which is compliant with EU legislation on how interconnector revenues can be used and how capacity is allocated, interconnector owners are allowed to earn returns, within a pre-set cap and floor range. This regime is designed to overcome the barriers to the existing merchant-exempt regime (whereby project developers must seek exemptions from certain aspects of European legislation) while maintaining market signals for efficient investment.¹¹³

¹¹³ <https://www.ofgem.gov.uk/ofgem-publications/59243/cap-and-floor-regime-regulated-electricity-interconnector-investment-application-project-nemo.pdf>

441. Ofgem is also reviewing the existing GB electricity network system planning and delivery arrangements, including for interconnection, through its Integrated Transmission Planning and Regulation (ITPR) project.¹¹⁴ The outcomes of that project may further influence how interconnectors other than NEMO are regulated, including how the relative merits of potentially competing projects are assessed. Finally, as signalled in DECC's publication last year, 'Electricity System: Assessment of Future Challenges',¹¹⁵ the Government is developing its own evidence base on the impacts of further interconnection and we envisage publishing a policy position around the end of 2013.

4.2.2.7 Pre-qualification

442. A pre-qualification stage will open around four months ahead of the auction and is designed to confirm the eligibility and bidding status of all potential capacity.
443. The purpose of pre-qualification is to ensure that participants in the Capacity Market auction can deliver the capacity they offer, and to ensure National Grid is able to mechanically adjust the amount to auction in the Capacity Market based on the volume of capacity opting out of the auction which states they will be operational for the delivery year. This will be achieved by de-rating such opt out capacity to the minus two standard deviation figure for their specific fuel type (see Section 4.8) and subtracting this from the volume of capacity to be auctioned.
444. To ensure National Grid has the best information for adjusting the amount to auction, participation in the pre-qualification stage will be mandatory for all generation covered by a generation licence, although there will be reduced administrative requirements on plants that do not intend to participate in the auction.
445. Though an agent may be appointed to deal with administration, the Government proposes responsibility for pre-qualification submissions should reside with the legal owner of each generating unit (the 'applicant'), where that entity is a UK limited liability company. An exception process will exist to consider representation where another entity has dispatch control of the asset or where the owner has an alternative or overseas legal structure. The applicant in respect of DSR will be the provider with the commitment to reduce customer demand for each of the relevant CMUs.

¹¹⁴ <https://www.ofgem.gov.uk/ofgem-publications/52728/itpremergingthinkingconsultation.pdf>

¹¹⁵ https://www.gov.uk/government/uploads/system/uploads/attachment_data/file/48549/6098-electricity-system-assessment-future-chall.pdf

446. Section 4.8 includes more detail on the proposals for pre-qualification, and should be reviewed before answering the consultation questions relating to pre-qualification included in this subsection.

Figure 4.8: Proposed pre-qualification and auction timeline

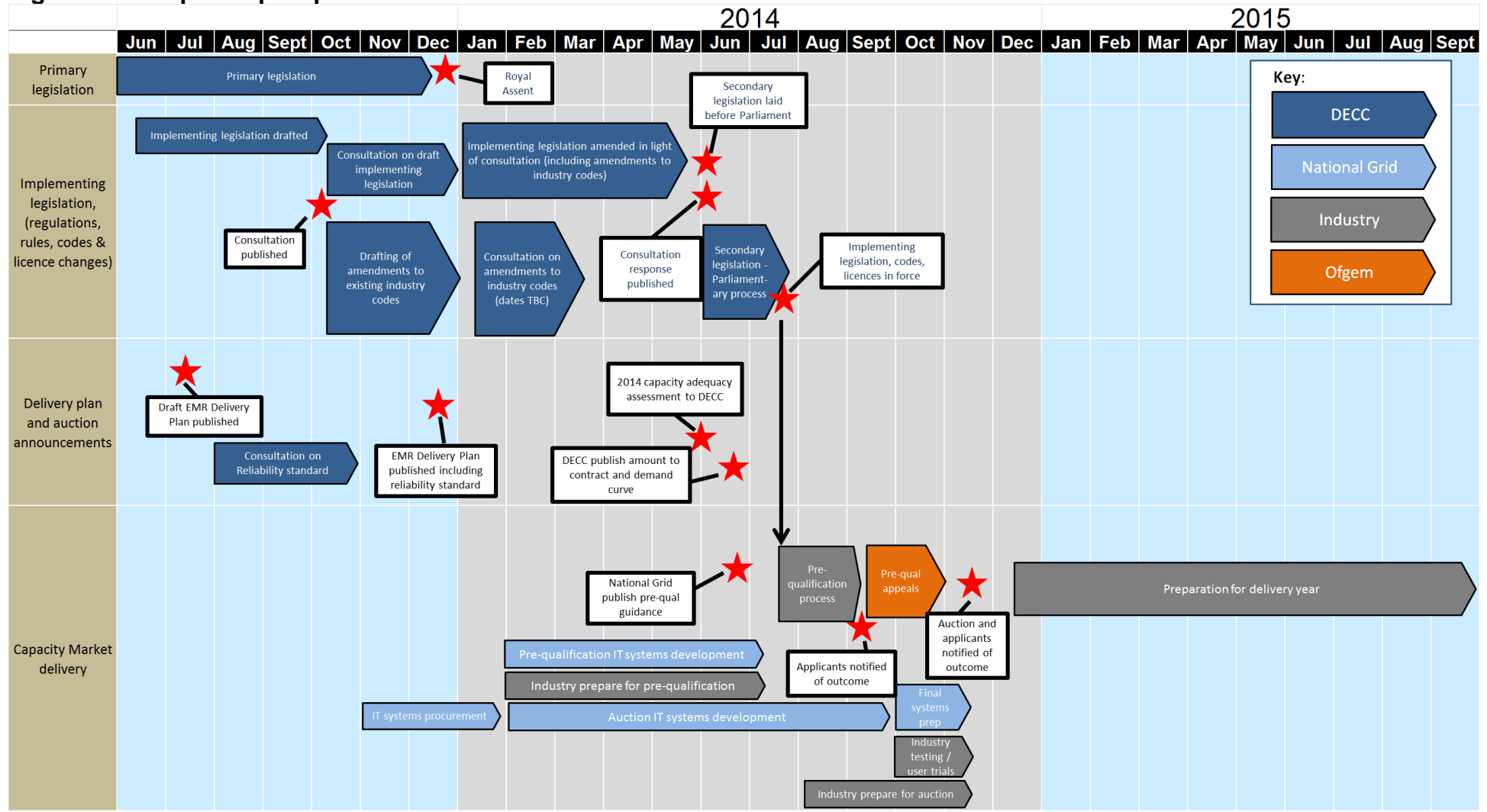

Note: a more detailed timeline of the full process from pre-qualification to auction has been developed as part of an open collaborative development process with industry, and is available here:

https://www.gov.uk/government/uploads/system/uploads/attachment_data/file/246238/Capacity_Market_draft_timeline_collaborative_development_.pdf

4.2.2.8 Disputing the outcome of pre-qualification

447. There will be a dispute process for participants considered ineligible as a result of the pre-qualification stage.
448. In the first stage of the dispute resolution process the appellant will be required to provide justification and supporting information for a dispute to National Grid, and to notify Ofgem of the dispute, within five working days of being notified of the outcome of pre-qualification. The appellant will be able to include additional content or correct previously submitted data in their appeal notification if needed.
449. National Grid will have five working days to respond to the appellant on eligibility-related appeals, and will either uphold its original decision or amend it. If National Grid's position is disputed further then the appellant must formally notify and provide Ofgem with supporting documentation / arguments within five working days of receiving the latest decision from National Grid.
450. Once Ofgem receives the appellant's request and supporting documentation, it may delegate consideration of each case and the provision of a recommendation to a party of its choice. This could be an independent panel established by Ofgem or an existing body.
451. We envisage that Ofgem would only be able to review the information provided to National Grid to ensure that National Grid took the decision correctly. This can include information provided at the first stage. No further information may be provided at this stage by either the appellant or National Grid. Ofgem must make a determination within a limited number of working days (time allocation still to be determined) in favour of one of the two parties and this decision will be substituted for the original. We recognise that there is a risk that Ofgem may not be able to resolve all appeals within the allocated time. In this case, we propose that there will be a process such that either the Secretary of State has discretion to delay an auction, or the auction will go ahead, whilst Ofgem continue to work through the remaining appeals, and capacity agreements may be awarded retrospectively. In the event that appeals are not resolved within the allocated time it is proposed that Ofgem notify the Government of the applications that have been resolved, and those remaining on a regular (e.g. fortnightly) basis.
452. Should an unsuccessful appellant wish to make a formal appeal against Ofgem's decision, they must submit their notification to appeal to the court within 28 days of receiving Ofgem's decision. The court to which these appeals would be submitted is expected to be the High Court in England and Wales, and the Court of Session in Scotland. These appeals may be heard by the Upper Tribunal rather than the High Court although this should make no substantive difference to the process for appeal. At this stage Ofgem would be the defendant.

453. The court will have the power to order National Grid to give a successful appellant an offer of a capacity agreement for the amount of capacity under dispute valued at the clearing price for the auction in which they were originally deemed ineligible to participate in. The auction result would not be re-run nor its results affected.

Box 4.7: Most relevant sections of the draft instruments that relate to this sub-section

Regulations:

2. Part 4: Capacity auctions
 - i. Chapter 3: Eligibility criteria
3. Part 6: Low carbon CMUs
4. Part 9: Appeals

Capacity Market Rules:

- Chapter 2: Auction Guidelines and De-Rating
- Chapter 3: Pre-qualification information
- Chapter 4: Determination of eligibility and de-rating
- Chapter 10: Transitional Arrangements
- Chapter 12: Disputes and appeals

Box 4.8: Consultation questions:

Eligibility and pre-qualification

Question CM08	<ul style="list-style-type: none"> • Do you think the proposed limitations on eligibility for participating in the Capacity Market are appropriate? For example, do they give rise to particular issues for any technology type?
Question CM09	<ul style="list-style-type: none"> • Are you aware of any solutions that might permit interconnected capacity to participate within the Capacity Market that would meet the Government's criteria as set out in this document?
Question CM10	<ul style="list-style-type: none"> • What are your views on the approach to pre-qualification, including the submission criteria, time allowed for the process and the deadlines industry will be required to meet?
Question CM11	<ul style="list-style-type: none"> • Are you aware of other ownership/legal structure arrangements that should be accommodated in the definition of applicants able to register for pre-qualification? If so please provide details.

Question CM12	<ul style="list-style-type: none"> Do you think the proposed methodology for de-rating capacity, and the proposed range, is robust? What are your views on the proposals for the auction to credit units at the fuel-type average availability level, rather than the unit's selected de-rating figure?
Question CM13	<ul style="list-style-type: none"> Do you think the level and type of collateral requirements for new build plants are appropriate?
Question CM14	<ul style="list-style-type: none"> Do you have any comments on the proposed process for dealing with pre-qualification disputes?
Question CM15	<ul style="list-style-type: none"> Do you have any further comments on aspects of the design described in this sub-section?
Question CM16	<ul style="list-style-type: none"> Do you have any comments on Chapter 3 of Part 4 and Parts 6 and 9 of the regulations and Chapters 2, 3, 4, 10 and 12 of the Capacity Market Rules for implementing proposals for eligibility and pre-qualification?

Section 4.2.3: Auction frequency, format and agreement lengths

454. This sub-section covers the frequency and timing of capacity auctions, the format of the auctions, and the agreement term lengths participants can bid for.

Figure 4.9: Amount to auction

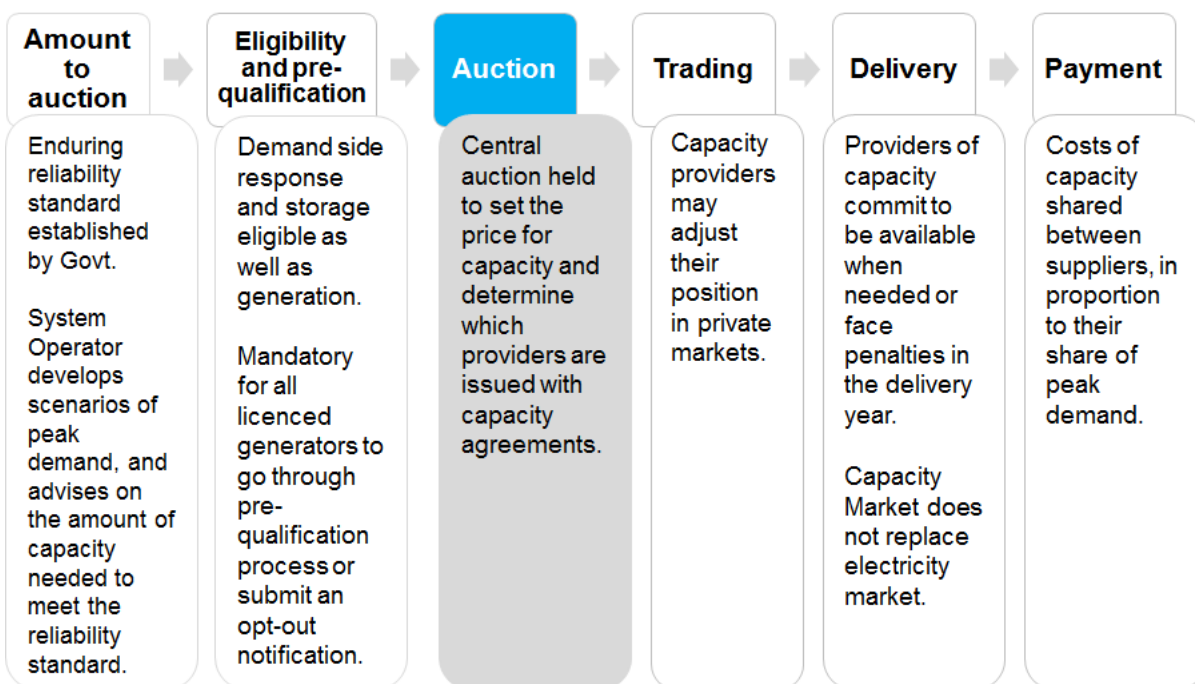

Summary of proposals:

- For each delivery year, an auction will be held four years ahead of delivery, supplemented by a further auction one year ahead of delivery to enable the participation of DSR and provide an opportunity to refine the level of capacity for which capacity agreements are issued.
- National Grid will have the capability to run zonal auctions if necessary to manage constraints but no such zones will be created unless approved by Ofgem.
- The auction will be 'pay as clear' – that is, all participants will receive the clearing price set by the marginal bidder. It will follow a descending clock format, in which the price offered is gradually reduced until the minimum price is reached at which the supply of capacity offered by bidders is equal to the volume of capacity required.
- To mitigate market power, bidders will be classified as either 'price takers' (who cannot bid above a relatively low threshold) or 'price makers' (who can). We expect most bidders will default to being price takers. New entrants and DSR resources will be classified as price makers, and will be free to bid up to the overall auction price cap (set at a multiple of the cost of new entry).
- Existing plants will default to one year capacity agreements unless they require major refurbishment, in which case they may be eligible to access a capacity agreement with a term of up to three years in each round of the auction.
- New entrants will have access to a longer term agreement for a term they nominate up to a maximum term limit.
- The Government proposes to initially set the thresholds for accessing longer term agreements at around £125/KW for three year agreements and £250/KW for new entrants' longer term agreements.

4.2.3.1 Auction frequency

455. A main auction for pre-qualified capacity will be held every year, for delivery in four years' time (e.g. an auction in 2020 would be for delivery in 2024/25, with the delivery year running from 1 October 2024 to 30 September 2025).
456. A further year-ahead auction will be held in the year immediately prior to the delivery year of the main auction. The process for setting the demand curve for this auction is the same as that for the main (four-year ahead) auction – National Grid will provide analysis on the amount of capacity needed to meet the reliability standard, with the final decision taken by the Government.
457. The year ahead auction will allow the Government some flexibility to alter the total amount of capacity for which agreements are signed in each delivery year to match more up to date expectations of the amount of capacity needed to meet the reliability standard.

458. Some capacity will be held back from the four year ahead auction and ‘reserved’ for the year ahead auction. The amount of reserved capacity will be based on an assessment of the amount of the cost effective DSR that could participate in an auction, and will be made public when the demand curve for the four year ahead auction is published.
459. If demand falls between the four-year ahead and year ahead auctions, the amount of capacity auctioned in the year ahead auction will be reduced. However, because the year ahead auctions will also be important for enabling DSR capacity (which finds it difficult to participate in an auction four years before delivery) to actively participate in the mechanism, the target volume of capacity for the year ahead will be at least 50% of the capacity that was reserved for it at the four year ahead stage will be procured.¹¹⁶ This is to ensure that there is a market for DSR participants and to remove some of the uncertainty on them as the industry develops.
460. Flexibility will be retained to remove this guarantee if DSR does not prove cost effective in the long run or if the DSR industry is considered sufficiently mature to manage the risk of years with no capacity agreements available a year ahead of delivery.
461. The Government expects to run year ahead and four year ahead auctions for each delivery year, but once prequalification for an auction has been completed, the Government will make a final decision about whether to hold that auction. Once an auction has commenced, there will be no Government discretion to influence the outcome. Once an auction has been completed, the Government will receive a report from the auction monitor (see below) and review the outcome. The auction result will stand unless invalidated by the Secretary of State within 10 business days.

4.2.3.2 Auction format

462. Each auction will be run on a ‘pay as clear’ basis, which means all successful auction participants will be paid the same price per unit of capacity, and the price will be set by the most expensive successful bidder.
463. Pay as clear auctions should prove more cost effective than ‘pay as bid’ (where participants receive the amount they bid) for a number of reasons. First, pay as clear provides the right investment signals:
- In the existing energy market, capacity is rewarded with a single price – the electricity price. A Capacity Market should dampen wholesale electricity prices, so it is right that existing generators are compensated through capacity payments on the same terms as new plants. Treating existing and new plants differently would create regulatory risk that will increase the cost of bringing forward new plants.

¹¹⁶ The target amount is the amount of capacity that the System Operator will procure if the auction clearing price is equal to net-CONE, with the demand curve and price cap allowing for more or less capacity to be procured according to the price.

- A pay as clear auction provides incentives for the market as a whole to become more efficient, since the most efficient providers of capacity effectively earn a premium by being paid the clearing price.

464. Second, theory and evidence suggest pay as bid would be more costly for consumers:

- This is because existing plants could 'game' a pay as bid auction by bidding in at the clearing price rather than bidding their true costs. A pay as bid auction can in fact lead to perverse outcomes if parties guess the clearing price incorrectly and then bid too high. This could mean that economically inefficient decisions are made e.g. to build new plants rather than pay cheaper existing plants to stay open.
- A pay as bid approach can also harm competition as big portfolio players are much better placed than independents to correctly guess the clearing price and so are better able to game the system.

465. The Government has carefully considered a range of auction design options as part of our design process, and has engaged international experts on auction design to advise on this given its centrality to the effectiveness of the mechanism. Analysis suggests the longer term advantages of a pay as clear approach outweigh any short term benefits of pay as bid auctions. All similar international mechanisms take a pay as clear approach.

466. The Government intends to run the auction in a descending clock format. This involves providers confirming they will offer capacity at a particular price, and then further rounds being held at lower and lower prices until the auction discovers the minimum price at which sufficient capacity is supplied.

467. The Government considers this to be more suitable for buying capacity than a sealed bid format in which providers state the minimum price they need and the auction is completed in a single round. The advantage of a descending clock auction over a sealed bid auction is that it allows greater price discovery for capacity providers:

- Providers (particularly new entrants) face considerable uncertainty when estimating capacity costs.
- Estimates of capacity costs involve 'common values': many aspects of costs will be similar across projects (e.g. how much energy revenue they will receive); however, each provider will each have their own estimates of these costs.
- Where common values are significant, sealed bid auctions have a tendency to lead to the 'winner's curse' – the successful participant(s) are often those who have overestimated revenue/underestimated costs, not the most efficient providers.
- The ability to observe the behaviour of participants in previous rounds in a descending clock auction, and adapt bidding behaviour on this basis, mitigates this risk, and should increase the likelihood that the most efficient providers win capacity agreements.

468. The use of a descending clock format is consistent with the design used internationally in similar capacity auctions.¹¹⁷

4.2.3.3 Auction cancellation, Certificate of Ethical Conduct, and the auction monitor

469. Naturally, unforeseen issues may arise once an auction starts and it is prudent to put in place checkpoints (and contingency plans) which would allow for cancellation or suspension of the auction. If the volume of capacity participating in the four-year ahead auction is less than 1.5GW above the target volume the auction will be postponed or cancelled to avoid running an undersubscribed and uncompetitive process.
470. There will be no minimum level of capacity that must come forward for the year ahead auction to proceed. However, the price of capacity will be capped (see Section 4.2.1).
471. In addition the Secretary of State will have additional discretion to postpone or cancel the auction following the conclusion of prequalification if there is reason to think that the auction would be insufficiently competitive – for instance if a significant proportion of capacity is provided by a single provider.
472. The auction rules will include a specific prohibition on Capacity Market participants engaging in market manipulation and insider trading. The current proposal is that such prohibitions would be enforceable as if they were relevant requirements under the Electricity Act, with Ofgem having the power to undertake enforcement action.
473. Each auction participant will additionally have to sign a ‘Certificate of Ethical Conduct’ that states, amongst other things, that they have complied with applicable competition law, anti-bribery legislation and have not engaged in market manipulation.
474. It is proposed that an auction monitor will be appointed to verify that the auction rules were followed and resolve any disputes between the auctioneer and capacity providers. The auction monitor will provide a report to the Secretary of State on whether the proper auction process was followed. If the auction monitor detects any irregularities in the auction process that could have materially altered the auction outcome, the Secretary of State may choose to nullify the results of the auction within seven business days of it being run. The Secretary of State can then choose whether to rerun the auction.

4.2.3.4 Locational constraints

475. The GB electricity market operates as a single market with locational signals for the provision of electricity being provided through transmission charging arrangements. The Government considers it inappropriate to introduce additional location signals through EMR while the

¹¹⁷ For example, the ISO New England and PJM capacity markets in the United States.

electricity market remains a single zone. The Government does not anticipate there to be any need for locational pricing in the near future since it is unlikely that there will be transmission constraints at times of system stress. The 2012 Ofgem capacity assessment indicated that the Cheviot boundary (between England and Scotland) should not have a significant impact on electricity security of supply for GB due to the planned investment in upgrading its capacity.

476. However, if in future Ofgem decides the implementation of the EU Target Model requires market splitting, or if in future capacity from outside Great Britain is able to participate in the Capacity Market and there are capacity constraints across interconnectors, it would be possible to run zonal auctions.

4.2.3.5 Price takers and price makers

477. Although participation in the pre-qualification process will be mandatory for generating plants covered by a generation licence and other CMUs wishing to participate in the Capacity Market, participation in the auctions themselves will be voluntary (i.e. we do not propose to force generators to participate in the auctions, or to close if they choose not to participate).
478. To mitigate the potential abuse of market power, in particular by existing plants seeking to force up the capacity price, at the pre-qualification stage all participants must register whether they wish to participate in the auction as price makers or price takers.
479. Existing generating CMUs will default to being a price taker (and, unless they submit evidence that they need to bid higher, will only be able to bid up to a relatively low threshold).
480. This threshold will be set to allow the majority of existing plants to participate in the auction as price takers, and should mean that only those plants with particularly high costs should participate as price makers and have to provide a justification for needing a higher level of payment. If successful in the auction, price takers will be offered a one year price and capacity agreement at the auction clearing price. The threshold will be set on a technology-neutral basis. The threshold is not intended to be a perfect reflection of the costs faced by existing plants – rather the proposed level of the threshold is intended to ensure that the majority of existing plants should be willing to participate in the Capacity Market without being price makers.
481. It is proposed to set this threshold at the lesser of 70% of the last auction clearing price set by a new entrant or half of net-CONE. This would be equal to £14.50/kW if a net-CONE of £29/kW were set in the first auction.
482. New plants and DSR capacity will automatically be able to participate as a price maker without providing a price maker justification.

483. Any existing plants wishing to bid above the price taker threshold would have to provide a statement approved by their board stating that they may need to receive a price higher than the price taker threshold to remain operational in the delivery year, along with a document providing justification for this. This justification must be provided to an appointed third party, by five business days in advance of the capacity auction. This third party will then provide a receipt to National Grid so that the provider will be qualified as a price maker in the auction. Ofgem would be able to request this information from the third party using its information gathering powers as part of any investigation into abuse of market power.
484. Existing plants that qualify as 'price maker' will be able to set a price in the auction below the threshold – i.e. they may change their mind during the auction as to whether they need a price above the threshold.
485. Any existing providers that bid a price above the 'price maker' threshold and do not receive a capacity agreement in the auction, but continue to operate in the delivery year, risk investigation by Ofgem, which may use information provided alongside the price setting auction bid.
486. To ensure there is no disincentive to investment before the Capacity Market is implemented, the Government has already decided that, subject to state aid approval, plants that began/begin construction between May 2012 and the first capacity auction will have the option of being treated as if they were new plants in the auction (i.e. they will be allowed to be a price setter and take a longer-term agreement). This also applies to existing plants undertaking a level of capital expenditure above the threshold that enables them to receive ten-year agreements.
487. Including the threshold below which bidders can submit bids with no supporting evidence will reduce the administrative burden on participants. Allowing even existing plants that have sunk all their investment costs but have material net go-forward costs to bid up to a threshold level is also appropriate because participants may be exposed to a risk of paying penalties greater than the total capacity payments they will receive.

4.2.3.6 Capacity agreement durations

488. If successful at auction an existing generation unit or a DSR or storage provider will be awarded a one year capacity agreement at the clearing price.
489. However, it is proposed that prospective capacity providers undertaking significant capital expenditure should be eligible for longer term agreements in the four year ahead auction.
490. The eligibility of prospective providers for longer term contracts will be based on the levels of planned capital expenditure, with a low threshold set to enable parties to access three year agreements and a higher threshold set to enable parties to access longer term agreements. These capital expenditure thresholds will be published prior to each auction.

491. The Government proposes to set the threshold for three year agreements at £125/kW in 2013 prices, and for longer term agreements at £250/kW. These long term contracts will be open generating CMUs (i.e. this does not include customer demand response (CDR) CMUs as the concept and thresholds have been designed around generation) provided that they demonstrate capital expenditure over the thresholds set¹¹⁸. The proposed thresholds are intended to ensure that plants undertaking routine cyclical maintenance will not be eligible for long term contracts, and that existing plants will only be eligible for longer term agreements if they are spending as much on capital as it could cost to build an entirely new plant.
492. Agreements for longer than one year will not be available in the one year ahead auction to avoid over-procuring for subsequent delivery years (given that four-year ahead auctions for following delivery years would have already taken place).
493. Where an existing generating unit is seeking a long-term contract, it will be re-entered as an existing unit in the auction at the point at which it exits as a refurbishing plant in the auction. It will then not be able to exit the auction until the price falls below the price-taker threshold unless the unit had also provided a price-maker justification in the prequalification phase.

Box 4.9: Additional rules for plants that have qualified for three-year agreements

- To ensure work has been completed by the start of the relevant delivery year, the Government proposes requiring a capacity provider with a capacity agreement for units awarded a three-year agreement to demonstrate that they have incurred at least 50% of the capital expenditure scheduled for at that point, as per their refurbishment plan, within a year of being awarded the capacity agreement.
- Any unit failing to demonstrate this would have its capacity agreement term reduced to one year.
- Parties with three-year agreements would also be required to demonstrate that their work was complete within 24 months of being awarded their capacity agreement so that additional capacity can be procured in the year ahead auction if necessary to correct any shortfall. Parties failing to demonstrate completion of their refurbishment work by this milestone would have their capacity agreement term reduced to one year. In addition, parties that fail to complete their refurbishment within 24 months will have their de-rated capacity for the delivery year adjusted to its pre-refurbishment level, and will be restricted to bidding for annual capacity agreements for the following two years.

¹¹⁸ See Section 4.8 for a description of the different types of CMU.

494. The provision of longer agreements for capacity undertaking significant capital expenditure is intended to afford to those providers an appropriate degree of longer term certainty when taking their investment decisions, which may also help to enable providers to secure project finance. This should support competition in the auction and drive down the costs of capacity.
495. However, this potential benefit has to be balanced against the risks associated with providing such long term agreements. Over time, capacity prices could fall (e.g. due to increased revenues through the energy market or due to the emergence of new technologies, the development of DSR, the development of the European internal energy market and an increase in interconnection to GB, or increased low carbon generation resulting in lower demand for capacity via the Capacity Market). Long term agreements may therefore lock in significant capacity at a particular capacity price, and prevent the market from fully benefitting from any fall in capacity prices over time and offering poor value to consumers.

Box 4.10: Additional rules for plants that have qualified for ten-year agreements

- It is important to ensure plants under construction holding capacity agreements have strong incentives to build on time (since if they are late or fail to commission altogether consumers will face potential higher capacity prices and additional security of supply risks, and other participants will (unfairly) bear a higher risk of facing penalties).
- To ensure they will be ready for the delivery year, new plants will be required to demonstrate that they have incurred at least 50% of the project expenditure scheduled to have been made, as per their construction plan, within a year of being awarded the capacity agreement.
- Failure to provide sufficient evidence will result in the termination of the capacity agreement and the application of a termination fee which it is proposed will be based on $0.5 * \text{net-CONE} * \text{capacity obligation}$. This termination fee will be funded from collateral which must be posted as part of new plants' pre-qualification.
- The Government proposes to require collateral sufficient to cover 100% of a plant's potential exposure to termination fees. For example, this will equate to one off collateral of c. £7.5m for a new plant with a 520 MW capacity obligation. The Government is considering whether the collateral requirement should be applied in respect of the 2014 capacity auction or from a later date.
- Types of acceptable collateral include:
 - An approved Letter of Credit or equivalent bank guarantee from a bank with a long term debt rating of not less than A3 by Moody's or A- by Standard & Poor's;
 - Cash deposit/prepayment (payment made before the delivery of the service);
 - Advance payment (payment made after the delivery of a service but before contract settlement);

- An approved ESCROW account;
 - A performance bond (provided by an insurance company, not a bank);
 - Bi-lateral insurance; and
 - Independent security.
- Plants will have their collateral returned in full if they are unsuccessful in the capacity auction, or when they successfully pass the 12 month milestone.
 - Capacity payments will be suspended for new plants until they become operational (though their agreement term will begin at the beginning of the delivery year). Such plants would not be liable for performance penalties until they had started to receive capacity payments.
 - Any new capacity failing to have at least 50% of the amount specified in its capacity agreement operational by 18 months after the start of its first delivery year will have its capacity obligation terminated, and be liable for a termination fee. The proposed formulation is $(0.5 * \text{net-CONE} * \text{capacity obligation} + \text{£10/kW}) * \text{the unit's capacity obligation}$. The additional £10/kW represents the economic damage emerging from increased security of supply risks resulting from their delay. Such capacity would be eligible to participate in subsequent auctions as a price taker. The Government expects plants with 50-90% of their capacity operational by this stage would have an additional six months to commission the outstanding amount, and if they are not completed by that date, their de-rated capacity will be adjusted accordingly.

496. Longer agreements also reduce the flexibility the Government has to make future changes to the GB electricity market. While the Capacity Market addresses fundamental failures in the electricity market, and is therefore expected to be required for at least ten years once implemented, it may at some point be desirable to transition away from the Capacity Market entirely in future as electricity markets in GB and Europe develop.
497. Offering long term agreements to new plants could also mean that existing plants – the majority of which will only be able to access one year agreements – are uncompetitive in the capacity auctions. This could mean building excessive amounts of new capacity when it would have been more cost-effective to retain existing capacity on the system.
498. One possibility is to offer capacity agreement of up to around 10 years for new build plants, which may balance the additional certainty of an extended term to investors against the increasing risk, as the term extends, of overall higher costs to the consumer and reduced flexibility for the evolution of the electricity market. However, some stakeholders have suggested that capacity agreement durations of up to 25 years for new build plants are desirable to reduce prices and protect against investors seeking to recover all capital costs during a shorter term length.

499. The Government is therefore seeking views on the appropriate agreement length to allow a sufficiently long period to provide certainty to investors and encourage new capacity to the market at the best possible price for consumers, while mitigating any gaming risks, but also balancing this against the risks that over time the consumer is exposed to higher costs by being locked into paying for capacity over a long period and that the competitiveness of existing plants is reduced relative to new plants.
500. One possibility is that bidders in the capacity auction will be assessed on price alone (a 'price only' auction) and not on the agreement duration they seek, except in the event of tie breaks between equally priced bids – where the shorter agreement will be preferred. Another option would be to run a dual auction where new build plants could bid for a 10 year or a 25 year agreement. This would allow discovery of the price difference between the two terms.
501. The draft secondary legislation published as part of this consultation has been drafted on the basis of a maximum 10 year capacity agreement. However, the issue of what is the appropriate term is set out in more detail in the Capacity Market Impact Assessment that will be published later this month and, as part of this consultation, the Government invites comment with regard to whether the auction on price alone and a maximum 10 year agreement is an appropriate balance of minimising longer term risks to the consumer and maintaining flexibility for efficient market evolution while encouraging new investment.

Box 4.11: Most relevant sections of the draft instruments that relate to this sub-section

Regulations:

- Part 3: Electricity capacity report
- Part 4: Capacity auctions
 - i. Chapter 1: Determining whether capacity auction to be held
 - ii. Chapter 2: Auction parameters
 - iii. Chapter 3: Eligibility criteria
 - iv. Chapter 4: Determining eligibility and holding capacity auctions

Capacity Market Rules:

- Chapter 4: Determination of eligibility
- Chapter 5: Capacity auctions
- Chapter 6: Capacity Agreements
- Chapter 7: Capacity Market register
- Schedule 1: Template Capacity Agreement Notice

Box 4.12: Consultation Auction frequency, format and agreement lengths questions:

Question CM17	<ul style="list-style-type: none"> • What are your views on the proposal for price takers and price makers? • What is the lowest price taker threshold that should enable the most existing plant to participate in the auction without needing to qualify as a price maker?
Question CM18	<ul style="list-style-type: none"> • Do you agree that that the relevant considerations to be taken into account when setting the capacity agreement length for new plant are the extent to which: <ul style="list-style-type: none"> • long term capacity agreements can reduce financing costs; • investors in new plant value capacity prices beyond the term of their capacity agreement; • long term capacity agreements risk locking in volumes of capacity which is not needed; • long term capacity agreements risk locking in high prices; • long term capacity agreements impact the ability of existing plant on one year contracts to compete? • Are there other considerations which should or must be taken into account?
Question CM19	<ul style="list-style-type: none"> • What do you consider to be the appropriate maximum agreement lengths for new, refurbishing and existing capacity?
Question CM20	<ul style="list-style-type: none"> • Do you think financial thresholds are appropriate for distinguishing between new and refurbishing plants? • Do you think the proposed levels of the thresholds are appropriate? • Do you have any views on the type of refurbishments likely to require a longer term agreement? What scale of investment would these plants be making?
Question CM21	<ul style="list-style-type: none"> • Is a 'price only' (i.e. selected on price alone, irrespective of the length of agreement) or a dual auction comparing bids for around 10 and 25 years more appropriate? If the latter, how should the preference be established?
Question CM22	<ul style="list-style-type: none"> • Do you think the additional rules proposed for prospective capacity providers that must build or refurbish their plant between the auction and delivery year are appropriate?
Question CM23	<ul style="list-style-type: none"> • Do you agree with the concept of termination fees being applied to new build plants that are not operational for their delivery year? Would it be more appropriate to make such plant liable for penalties in any system stress events?

Question CM24	<ul style="list-style-type: none"> Under what circumstances would it be appropriate to cancel holding an auction or to reject its results?
Question CM25	<ul style="list-style-type: none"> Should the Capacity Market create requirements for participants to bid fairly and to not engage in collusion or market manipulation? Do you have any comments on the proposed definitions of collusion and market manipulation in the Capacity Market Rules? Do you think that participants should have to sign up to a Certificate of Ethical Conduct in order to sign up to the auction? Do you think there are any potential gaps in existing competition powers that need to be addressed to ensure that Ofgem can ensure competition in the Capacity Market?
Question CM 26	<ul style="list-style-type: none"> What are your views on which party should act as auction monitor and what should be the scope of their role?
Question CM27	<ul style="list-style-type: none"> Do you agree that the Government should introduce a guarantee to auction 50% of the capacity initially set aside for the year ahead auction? Could DSR capacity compete without the guarantee?
Question CM28	<ul style="list-style-type: none"> Do you have any further comments on aspects of the design described in this sub-section?
Question CM29	<ul style="list-style-type: none"> Do you have any comments on Part 3 and chapters 1, 2, 3 and 4 in Part 4 the regulations and Chapters 4, 5, 6 and 7 and Schedule 1 of the Capacity Market Rules for implementing proposals for auction format and frequency

Section 4.2.4: Secondary market

502. This sub-section explains the opportunities and rules for secondary trading of capacity agreements between the auction and delivery year.

Figure 4.10: Secondary Market

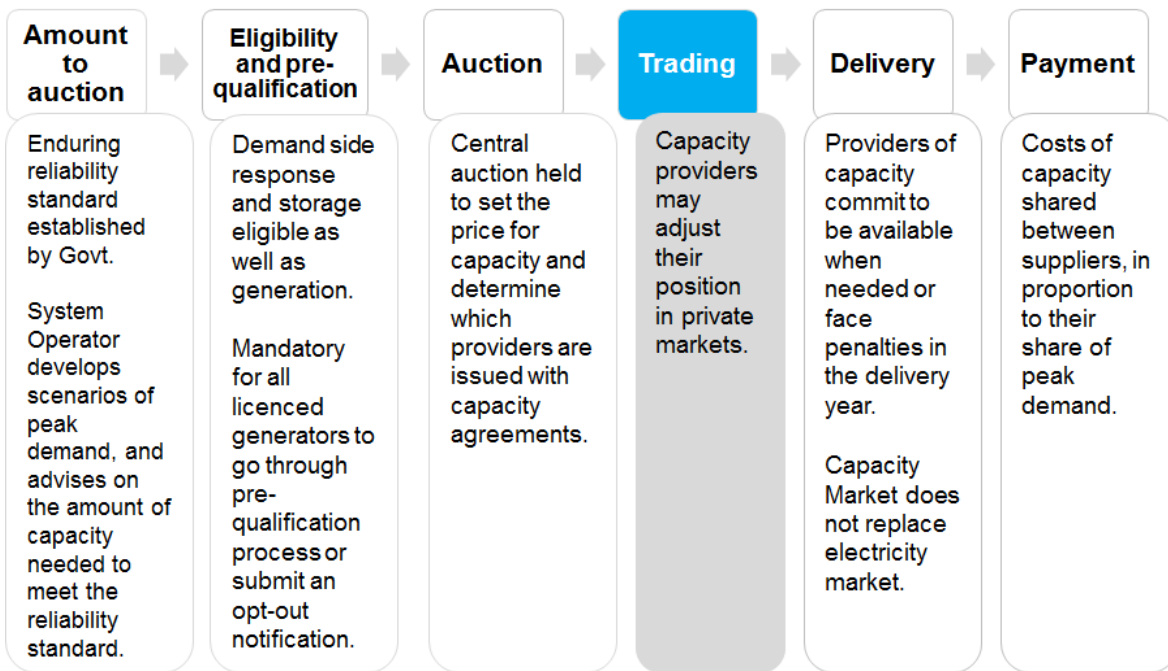

Summary of proposals:

- Providers can physically trade their obligations from a year ahead of the start of the delivery year and throughout the delivery year where there is additional unencumbered pre-qualified capacity that can take their place.
- Capacity is unencumbered if it has spare capacity as defined in the prequalification process and if the plant had not opted out in the previous prequalification process.
- National Grid will maintain a register of capacity obligations.
- A system of checks will be put in place by National Grid before physical trades are made to verify that the party taking on additional obligations is eligible to do so.
- Providers can also manage their penalty risk at any point through private financial hedging.

503. Secondary trading is an important tool for parties to manage their risk of exposure to Capacity Market penalties. Secondary trading can be physical or financial.

4.2.4.1 Physical trading

504. It is proposed to allow capacity providers to pass their capacity obligations on to other parties in specific circumstances. The party taking on an additional obligation must have participated unsuccessfully in previous auctions or else be certified as providing capacity that was not procured in previous auctions (such as a new build plant that commissions a year early).

However a plant that opted out of a capacity auction will not be eligible to take on subsequent obligations for the delivery year for which the capacity auction was held to ensure all participants have incentives to participate in the capacity auctions.

505. The Government proposes that providers may physically trade obligations at any point from a year ahead of the start of the delivery year and throughout the delivery year. Physical trades can only take place once checks have been completed on the validity of the trade – for example checking whether the assignee is pre-qualified and unencumbered by pre-existing obligations. There will also be provision for capacity that had not prequalified prior to the delivery year to be prequalified within a six-week period to enable it to take on obligations through secondary trading.
506. The purpose of restricting secondary trading until after the year-ahead auction, and the limited time window for physical trading, should prevent parties that fail to build new plants on time from profiting from higher prices in the year-ahead auction.

Box 4.13: Trading restrictions for participants holding obligations for plants that must be built before the delivery year

- Participants that wish to trade out of their physical obligation will be prevented from doing so if the demand curve for the year ahead auction has already been adjusted to take account of their prospective plant not meeting its construction milestones.
- New plants will be prevented from physically trading in respect of their second and third delivery years where they were not operational two weeks in advance of the year-ahead auction for the respective delivery years.

507. National Grid will be required to maintain a register of parties' pre-qualification status and the details of any capacity agreements awarded. This register will be consulted by National Grid to determine the eligibility of parties wishing to enter into bilateral physical trades. Access to this register may also be needed by the settlement body and its agent for the purpose of settling payments and/or to apply penalties. It is proposed to make a form of this register publicly available so parties can see who holds obligations, the size and agreement duration of the obligations, and which parties are eligible to take on additional obligations through secondary trading.
508. It is proposed that traded obligations will be frozen at the point of transfer for the purposes of penalty liabilities and contribution to liability caps. All historic liabilities would therefore remain with the provider which incurred the original penalties and would have to be settled by that provider according to Capacity Market rules. Providers will not be able to trade their capacity obligation if there is a liability for penalties in relation to that CMU which remains unpaid.

4.2.4.1 Financial trading

509. At any time, parties can hedge their position financially through private markets – for instance to avoid exposure to penalties while undertaking maintenance. Parties will be incentivised to trade in this market as they will have load-following obligations and will be paid for ‘over delivery’ in a stress event (see Section 4.2.5). This means that generators intending to run outside times of peak demand will be able to offer ‘spare’ capacity to those not choosing to run. Financial players will also be able to trade in this market, increasing market liquidity.
510. Providers trading financially will nonetheless remain liable for any penalties and will have to settle as normal with the Capacity Market Settlement Agent but they would recoup any costs from their financial trading partner. The Government does not intend to establish a trading platform for financial trading as the Capacity Market participants should themselves be best placed to find the products and trading platforms to manage their risk. However, the Government recognises the importance of a liquid secondary market developing, particularly for independent investors, and will keep under review whether there is an appropriate role for the Government in promoting financial trading.

Box 4.14: Most relevant sections of the draft instruments that relate to this sub-section

Capacity Market Rules:

- Chapter 7: Capacity Market register
- Chapter 9: Trading and assignment of capacity obligations

Box 4.15: Consultation questions: Secondary market

Question CM30	<ul style="list-style-type: none"> • Do you have any comments on the proposed provisions for secondary trading of capacity? Are there any better approaches? • Do you consider there are additional measures or design changes that the Government can take to facilitate a liquid hedging market around penalties for under-delivery?
Question CM31	<ul style="list-style-type: none"> • Do you have any further comments on aspects of the design described in this sub-section?
Question CM32	<ul style="list-style-type: none"> • Do you have any comments on Chapters 7 and 9 of the Capacity Market Rules for implementing proposals for secondary trading?

Section 4.2.5: Delivery

511. This sub-section explains the obligations on capacity agreement holders, and the penalties applicable to any capacity provider that does not meet these obligations.

Figure 4.11: Delivery

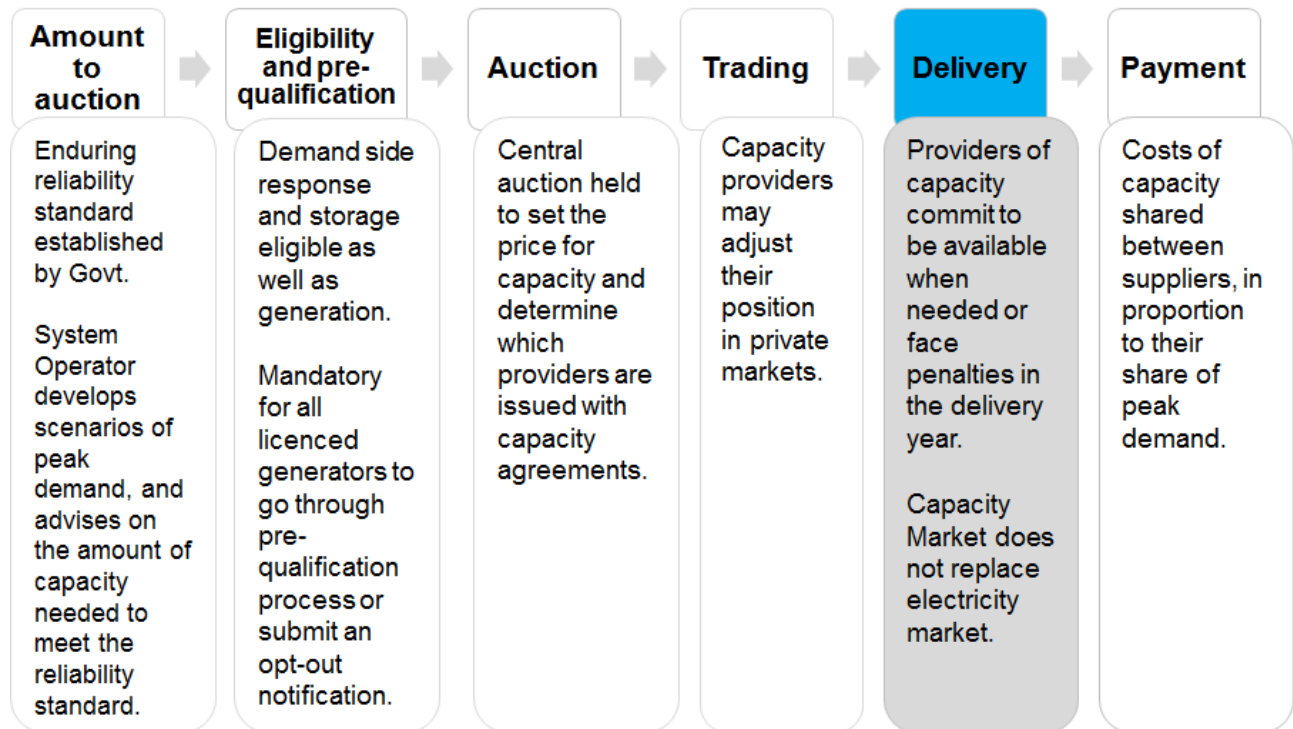

Summary of proposals:

- National Grid will issue a 'Capacity Market warning' in advance of any anticipated stress event, with such a warning acting as the dispatch signal for DSR capacity.
- Capacity agreements oblige participants to deliver a specified quantity of electricity in system stress periods. The quantity will vary subject to when stress events occur in relation to the publication of a Capacity Market warning:
 - Providers' obligations in periods of stress up to four hours after any Capacity Market warning will be based on their scheduled output.
 - Providers' obligations after four hours will be 'load following' (i.e. if a stress event occurs when total demand is at 70% of anticipated peak, they are only required to deliver 70% of their obligation).
- Once a warning has been issued, providers that do not deliver sufficient energy at the relevant time/s of stress to meet their obligation will be required to pay a financial penalty. No penalties will be applicable for stress periods where no advance warning was provided by National Grid.
- Penalties will be based on the value of lost load to reflect the value to consumers of

preventing blackouts.

- Providers' total penalty exposure in a delivery year will be capped at a multiple of the relevant auction's clearing price multiplied by their MW of capacity agreements held. Rules to create a 'soft cap' will ensure providers always have an incentive to deliver in times of system stress.
- Providers that deliver more than their obligation at times of stress will be paid for their excess delivery at the inverse of the penalty rate. Payments for over delivery will be made in stress events from the moment the warning is issued.
- National Grid will have the ability to spot test providers where they have failed to demonstrate their ability to deliver the level of capacity specified in their capacity agreement. Capacity payments will be forfeited by any plant which fails a spot test until the plant passes a subsequent test.

4.2.5.1 The capacity obligation

512. It is proposed to define system stress events as any settlement periods in which either voltage control or controlled load shedding are experienced at any point on the system for 15 minutes or longer.¹¹⁹ Periods of voltage control or load shedding resulting from failures or deficiencies in the transmission or distribution systems will not be considered as stress events. Similarly periods of voltage control or load shedding where the volume of disconnection is lower than the volume of National Grid's instructions for generators to reduce output, will also not be considered as stress events.
513. The decision on whether a capacity provider has met its obligation during a period of system stress will be based on the delivery of energy, or provision of a balancing service, during that period. Providers will be required to determine their own response at such times, and avoid breaching any existing code or licence conditions.
514. To ensure participants are able to adequately manage the risk of exposure to penalties, e.g. the risk that a number of plants simultaneously trip, National Grid will publish a Capacity Market warning, based on a pre-determined methodology, to highlight a high risk of inadequate system margin. Unless this warning has been issued, a system stress event will not trigger Capacity Market penalties or over delivery payments.

¹¹⁹ A stress event will be considered to start when the System Operator issues demand control instructions to relevant Distribution Network Operators (DNOs), or where demand is automatically disconnected by low frequency relays. A stress events will be considered to have finished when the System Operator instructs the last relevant DNO to reconnect demand. The link to instructions, rather than their implementation, will provide clearly auditable timestamps for any stress periods.

Box 4.16: Capacity Market warnings

- A Capacity Market warning will automatically be published by National Grid where the triggering criteria for an impending system stress event are met. These criteria will be designed to highlight a high risk of inadequate system warning, based on the available capacity (declared 'maximum export limit' (MEL) minus transmission system demand and reserve for response capacity. National Grid will not have any discretion over whether to publish the warning where the criteria have been met. The warning methodology will be kept under review to ensure it remains fit for purpose.
- The warning will act as a dispatch signal for DSR capacity. The delivery of such capacity will not be assumed when determining whether the trigger criteria for the warning had been met, given the requirement for such a dispatch signal.
- The warning will remain in force until midnight of the publication day, if not used, although National Grid may cancel it early if pre-defined criteria are met. National Grid will not, however, have discretion in respect of cancelling the warning early.

515. Different levels of capacity obligations will apply depending on whether the Capacity Market warning is published at least four hours ahead of any stress event occurring. A four hour warning period is proposed because it allows National Grid to make an accurate assessment of the likelihood of system stress (because wind forecasting is generally reliable four hours ahead), and also provides enough time for plant operators to adjust their output before penalties based on their capacity obligations apply.
516. Because this may reduce the longer term efficiency of the mechanism (e.g. by reducing the incentives for participants to invest in the right mix of reliable and flexible capacity that can respond to scarcity situations as they develop) the Government will review this approach once participants are used to the way the mechanism works and investors more comfortable investing on the basis of capacity agreements.
517. To ensure sufficient capacity is incentivised to deliver in the delivery year, it is proposed that a capacity agreement and obligation attached to a plant will transfer with the plant if the plant is sold. The new owner will have to take on the capacity obligation.

4.2.5.2 Level of obligation in system stress events

518. Capacity agreements oblige participants to deliver a specified quantity of electricity. A provider's obligation will be calculated from their obligations acquired in the four-year and year-ahead auctions, plus any secondary traded obligations acquired for the specific settlement periods in which a stress event occurs. The concept of the obligation is crucial given it is the baseline against which delivery performance in a system stress event will be calculated.

519. In stress periods preceded by a Capacity Market warning of less than four hours' notice, providers' capacity obligations will be fixed at the output level they specified they would deliver in their balancing mechanism physical notification/s. Providers that deviate from their physical notification(s) will be penalised at the penalty rate or paid for their over delivery. An alternative notification process will be developed for participating CMUs outside of the balancing mechanism which do not currently submit physical notifications. Providers will therefore not be required to deliver any more than what they were originally planning to deliver.
520. However, in stress periods preceded by a Capacity Market warning of at least four hours' notice, it is proposed that providers' obligations will be 'load following'. That means they will only be required to be generating electricity or reducing demand up to the total level of their obligation if all capacity with capacity agreements is required to meet demand. In a stress event where only 70% of the total capacity with capacity agreements is required to meet demand, each provider will only be required to be generating electricity or reducing demand up to 70% of their full capacity obligation.
521. Load following obligations are appropriate to ensure generators have incentives to operate efficiently in the market, and are proportionate to the harm caused to consumers by any lost load. If every participant risked being penalised for their full capacity obligation whenever there was system stress, the Capacity Market would create signals for plant to run warm even when it is economically inefficient for them to do so – increasing both emissions and consumer bills.
522. It is proposed to assess providers' performance at a portfolio level. This is to enable portfolio operators to make efficient decisions about which plants to run. It will also help them to manage risks related to plant maintenance. However, it is proposed that the penalty cap (see below) will also apply to a portfolio, which means the cap will provide less protection to portfolio participants since they are unlikely ever to reach their portfolio cap.

Box 4.17: Defining a portfolio

- A provider's portfolio will be determined on the basis of the control arrangements of the party owning the respective CMUs. The portfolio will apply at the level of the highest holding company ('ultimate parent') where that company has the means to appoint or remove the majority of board directors in the asset owning company.
- If no party has such control, but does have a decisive influence (as defined under the EC Merger Regulation 139/2004) over the asset owning company and a controlling influence over the party operating the unit, then the unit would be considered as being in the portfolio of their ultimate parent.

- If no party has such a controlling role, but there is one party only with a decisive influence over the asset owning company (but no controlling influence over the operator), then the unit would be within their ultimate parent's portfolio.
- If more than one party has a decisive influence over the asset owning company (again, with no controlling influence over the operator), then the board of directors of the asset owning company would be required to nominate the portfolio of one of the ultimate parents exercising such an influence.
- If no party has such a decisive influence then the unit would be considered within the asset owning company's portfolio.
- The 'ultimate parent' would be required to nominate a 'Portfolio Adjustment Payer', which is a UK-based affiliate of the portfolio holder. This should allow groups to manage any penalty liability and to place it somewhere which works for them from a tax and administrative perspective. The Government is still considering whether the nominated party should be required to be a capacity provider.

523. It is proposed that there should only be limited delivery exceptions provided for force majeure events outside of a provider's control, as to do otherwise would weaken delivery incentives and be unnecessarily costly for end consumers. A provider's delivery obligation will be suspended, and no penalties will apply where:
- a unit has been prevented from delivering due to transmission constraints by National Grid;
 - the electricity market has been suspended (under Section G of the Balancing and Settlement Code); or
 - a new plant has been delayed in commissioning due to Transmission Owner or Distribution Network Operator's delays in providing a connection to the transmission or distribution network.
524. No further exceptions are proposed to be made in respect of force majeure situations. This position replicates the Balancing and Settlement Code's treatment of contingencies, which is important given the interaction between the Capacity Market's penalty regime and cash out incentives.

4.2.5.3 Penalties

525. Providers that do not deliver sufficient energy at notified times of stress to meet their obligation will be required to pay a penalty.
526. It is proposed to link penalties to the value of lost load (VoLL), adjusted by a scaling factor, minus the prevailing 'System Buy Price' (i.e. 'cash out') imbalance price for each half hourly settlement period in which there was system stress. VoLL is the theoretical value to consumers of preventing blackouts. In other words, it is the price at which a consumer is

indifferent between paying for electricity and not having any. Since the purpose of the Capacity Market is to prevent blackouts, using VoLL (the value to consumers of preventing blackouts) as a basis for Capacity Market penalties will help ensure capacity providers have the correct economic incentive to provide capacity.

527. In a perfectly efficient energy-only market, cash out prices would rise to VoLL (c. £17,000/MWh¹²⁰) at times of scarcity, and should eventually provide the long term certainty investors need to build sufficient capacity to provide security of supply. However with a Capacity Market in place, the market should be incentivised to invest in capacity without performance incentives needing to rise to the full level of VoLL. The use of a penalty scaling factor therefore allows for a level of performance incentives that is appropriately strong but that is not overly punitive and so does not significantly increase financing costs for new investment or deter independent investors from entering the market.
528. The subtraction of the cash out price from the penalty level recognises that cash out and the Capacity Market penalty regime both provide performance incentives. If the cash out price was not subtracted from VoLL then capacity providers would face more than the economically optimal penalty for failing to deliver capacity when required, which would impact on the investability of the Capacity Market and reduce the level of competition in the auction.¹²¹
529. The penalty rate for a settlement period in a period of system stress would therefore be (penalty scaling factor X £17,000/MWh value of lost load) minus the system buy (cash out) price. The penalty scaling factor will be used to adjust the VoLL element of the penalty formulation from £17,000/MWh to a lower level. The Government proposes to set the penalty scaling factor at a level to provide an additional Capacity Market penalty of between £1,000 and £3,000/MWh – assuming Ofgem’s Electricity Balancing Significant Code Review (EBSCR) has set a single cash out price of £6,000/MWh (in 2018) as per Ofgem’s current proposals. This proposal recognises the need to keep an element of penalties in the Capacity Market, even if cash out is reformed to £6,000/MWh. Maintaining incentives in the Capacity Market ensures that the payment for particular providers reflects the true reliability of the plant (which cannot be perfectly estimated prior to the auction).
530. For example, if the penalty scaling factor was set at 0.475 then the penalty rate (£/MWh) for a system stress event would be $(0.475 \times £17,000) - £6,000$ (assuming that the event occurred at a time when the load following obligation is 100% of the providers capacity

¹²⁰

https://www.gov.uk/government/uploads/system/uploads/attachment_data/file/224028/value_lost_load_electricity_gb.pdf

¹²¹ If they are not delivering but had notified Elexon that they *would* deliver they would have to pay the cash out price on top of VoLL. If they are not delivering and have notified Elexon that they would not deliver then they miss out on the high energy prices driven by the stress event.

obligation). This would result in a penalty of £2,075 being applied for every MWh that the unit fails to deliver relative to its capacity obligation.

531. We expect that capacity outside of the balancing mechanism, e.g. some forms of Demand Side Response capacity, will be exposed to capacity penalties of (penalty scaling factor X VoLL) rather than the penalty rate referenced in the previous paragraphs. This is to ensure that all capacity has the same performance incentives (as plant outside of the balancing mechanism is not exposed to cash out incentives). However, some stakeholders believe that at least some of this capacity is exposed to cash out incentives and have also suggested that this will expose this capacity to unmanageable levels of risk. As such, the Government is keen to receive evidence on this point through this consultation.

4.2.5.4 Penalty capping

532. Capping penalty liability is important to ensure providers of new capacity can secure finance, and will contribute to competitive electricity and capacity markets.
533. The Government proposes to cap a unit's total penalty exposure in a delivery year at a percentage of their unit's clearing price multiplied by their MW of capacity agreements held. The Government is minded to set this percentage within a range of 101% – 150% of the unit's annual capacity revenue to minimise the risk of gaming, as it would prevent providers that never intended to perform from taking a gamble in the expectation of receiving capacity payments without facing significant penalties. A cap below this level could be viewed as providing 'free' money to providers because even if they never delivered capacity it would be impossible to apply sufficient penalties to recover the capacity payments they would have received.
534. The penalty cap formulation has been designed to ensure that providers will have continued incentives to deliver at future times of system stress even if they have performed poorly historically. A 'soft' cap will therefore work in conjunction with the 101-150% hard cap to moderate the rate at which the cap is reached and to ensure that delivery in subsequent events would reduce a provider's overall penalty liability. The soft cap means units always have an obligation to deliver when required, since they can reduce their overall penalty liability by performing in future scarcity events (where without the soft cap, they would lose this incentive as soon as the hard cap was reached).
535. An additional cap will apply at the portfolio level, set at the same percentage level as the unit level caps. The penalty obligation on the portfolio holder (or delegated affiliate) will be the difference between the sum of the liabilities of the constituent units within their portfolio and the resultant penalty exposure if it had been calculated directly at a portfolio level (i.e. only to the extent that the individual units within the portfolio had capped out and there is unused or surplus cap in the portfolio). This position is proposed so that investors' liability in respect of an individual unit is capped at a percentage of its annual Capacity Market revenue, but whilst retaining portfolio-wide incentives for secondary trading.

4.2.5.5 Over delivery

536. Since at times of stress it is beneficial to have all available capacity on the system (until demand is met), providers that deliver more than their capacity obligations at times of system stress, preceded by a Capacity Market warning, will be paid for their over delivery. Only providers holding capacity agreements, who notify the amount they will deliver to National Grid before gate closure or react to specific National Grid instructions and comply with their obligations under the Balancing and Settlement and Grid Codes, will qualify for this payment.
537. The rate of over delivery payments will be calculated by dividing the total penalty payments received by the settlement body in a stress event by the total amount of over-delivered energy in the same stress event. This rate will be capped at the prevailing Capacity Market penalty rate. In the event that no penalty payments are received as a consequence of a stress event then no payments for over delivery will be made.
538. We recognise this position reduces surety as to the expected value of over delivery payments. However, the mechanism has been designed to ensure that penalties equal over delivery payments and we do not envisage scenarios in which there is a material shortfall. Though views are welcome on the impact of this proposal, this means that the cap on over delivery payments should not materially affect incentives for secondary trading.

4.2.5.6 Spot testing

539. National Grid will have a duty to spot test providers in circumstances where providers have failed to demonstrate their capacity volumes on three occasions of the provider selection over the winter period of a delivery year. This is because we do not expect there to be regular stress events and therefore we need a means to check participants are able to perform. Generators will be able to nominate (*ex-post*) any three settlement periods in which they have delivered at least their de-rating figure over the winter peak period. DSR providers will have to nominate a maximum of six periods in advance, in which they must demonstrate a prescribed demand reduction on three occasions.
540. Providers designated for a spot test will be required to deliver the amount of their capacity agreements at a date and time specified by National Grid, with penalties being applied for providers not able to demonstrate when tested. The exception to this is DSR providers who would be required to demonstrate a load following obligation. Plants would receive six hours' advance notification of the test periods to enable them to sell the energy they will be generating during the test into the electricity market. National Grid would be limited to testing any specific plant on a maximum of two occasions within a particular delivery year.
541. Capacity payments will be forfeited by any plant which fails a spot test until the plant passes a subsequent test. The provider would remain liable for their delivery obligations at times of system stress. The provider could request a retest at any time after their initial unsuccessful test. In addition a provider's payments would be reduced for the subsequent delivery year.

542. No specific funding for testing would be provided, with providers pricing in the risk of such tests into their auction bids.

Box 4.18: Most relevant sections of the instruments that relate to this sub-section

Capacity Market Rules:

- Chapter 7: Obligations of capacity providers and system stress events
- Chapter 9: Capacity incentives
- Chapter 11: Monitoring
- Chapter 13: Testing regime
- Chapter 14: Capacity incentives

Box 4.19: Consultation questions:

Delivery

Question	Delivery
Question CM33	<ul style="list-style-type: none"> • Do you agree that liability for penalties should be conditional on the issue of a Capacity Market warning? If so, is the proposed four-hour period appropriate?
Question CM34	<ul style="list-style-type: none"> • Do you think the proposed penalties applicable for non-delivery both more than and less than four hours after a Capacity Market warning are appropriate?
Question CM35	<ul style="list-style-type: none"> • Do you think that a penalty cap of between 101 – 150% of a unit's annual capacity payments achieves an appropriate balance of consumer value for money, delivery incentives and investability?
Question CM36	<ul style="list-style-type: none"> • Do you agree with the proposal that penalty caps should be determined at the portfolio level? If so, do you agree with the approach for determining portfolio structure?
Question CM37	<ul style="list-style-type: none"> • Do you think that the proposal to apply different penalty rates to units depending on their balancing mechanism status is appropriate and offers value for money to consumers?
Question CM38	<ul style="list-style-type: none"> • Do you think that over delivery payments are an important design feature for providing efficient despatch incentives and facilitating secondary trading?
Question CM39	<ul style="list-style-type: none"> • What are your views on the proposals for identifying and spot testing participants' ability to deliver when needed?

Question CM40	<ul style="list-style-type: none"> Do you think the proposed treatment of ‘force majeure’ events is appropriate and offers value for money to consumers?
Question CM41	<ul style="list-style-type: none"> Do you have any further comments on aspects of the design described in this sub-section?
Question CM42	<ul style="list-style-type: none"> Do you have any comments on Chapters 7, 9, 11, 13 and 14 of the Capacity Market Rules for implementing the proposed obligations and penalties?

Section 4.2.6: Payment

543. This sub-section explains at a high level how the capacity payments will be funded and the roles involved in Capacity Market payment flows. For more detail, please see Section 4.4.

Figure 4.12: Payment



Summary of proposals:

- Payment flows between electricity suppliers and capacity providers will be the responsibility of a Government-owned settlement body with a number of functions

carried out by a settlement agent.

- The costs of the Capacity Market will be recovered from electricity suppliers according to their share of peak demand.
- Residual monies from penalties from capacity providers, less any over delivery payments to capacity providers, will be returned to electricity suppliers according to their share of peak demand.

544. Payment flows between suppliers and capacity providers will be managed by a settlement body assisted by a settlement agent. This payment model is well understood and accepted and is essentially the same structure that was used by the former England and Wales Power Pool from 1990 and subsequently from 2001 in the New Electricity Trading Arrangements and from 2005 in the British Electricity Trading and Transmission Arrangements for imbalance settlement. The Government announced the decision to designate Elexon Ltd (Elexon) as the Capacity Market settlement agent in February 2013. The Capacity Market Settlement Body's costs (including those of the settlement agent) will be funded through the levy that suppliers are obligated to pay.
545. The Government announced the decision to designate Elexon as the Capacity Market Settlement Agent in February 2013.
546. The cost of capacity (including capacity payments and settlement body costs) will be recovered from all licenced suppliers (with no exemptions) according to their total peak demand. Charges will initially be based upon forecast demand data but later reconciled based on actual demand when meter data is available. All payment flows will take place in the delivery year (so although from the point of the auction the overall levy rate will be known, no payments will be made until the delivery year).
547. The Government proposes to require suppliers to lodge collateral with the settlement body so that their payment obligations for one month can be covered in the event of default. Any payment defaults remaining once a supplier's collateral is exhausted will be mutualised across the remaining supplier base (i.e. other suppliers would have to cover this default) to ensure the settlement body is always in a position to pay capacity providers.
548. Residual monies from penalties less any costs from over delivery payment to capacity providers will be distributed to suppliers – split between suppliers pro-rata according to their forecast total peak demand. Charges will be reconciled based on actual demand when meter data is available.
549. Capacity providers will not be required to lodge any collateral against potential penalty payments. Any initial default by providers will be covered by withholding future capacity revenues. Any defaulted penalty amounts outstanding once a defaulting capacity provider ceases to have a capacity agreement will be mutualised across suppliers. Ofgem may, where a party defaults through the non-payment of penalties in operating under a licence granted by

Ofgem, take enforcement action under the provisions of that licence after other reasonable options to remedy the default have been exhausted.

550. Net charges and/or payments to suppliers and capacity providers will be made monthly.
551. More detail on the proposals for Capacity Market payment and settlement is included in Section 4.4, along with consultation questions and references to relevant sections of the draft secondary legislation.

Section 4.3: Participation of demand side response (DSR), including embedded generation and smaller storage capacity

552. The Government is committed to building the capacity and capability of the demand side to participate in the Capacity Market. This is because the demand side has the potential to offer a more cost effective way of delivering security of supply and will compete with generation to provide a lower cost outcome for customers.
553. This section sets out proposals for how DSR (which includes on-site generation and smaller storage capacity) can participate. It also sets out the details of the transitional arrangements which will seek to expand this sector and to develop capability so that DSR can participate in the enduring Capacity Market as soon as possible. DSR provided in this way is provided by what is termed a CDR CMU (see Section 4.8 for more information on CMUs).
554. DSR capacity providers will be required to meet their capacity obligation by reducing demand below a baseline at times of system stress. This can be achieved by reducing demand or shifting demand: either is acceptable (and neither preferable) provided a measurable reduction takes place at times of system stress.
555. DSR can also be provided by 'behind the meter' generation. Such generation would normally accrue to a supplier's consumption account i.e. an upsurge in behind-the-meter generation would manifest as a reduction of demand accruing in the consumption account.
556. In addition to benefitting from the introduction of the Capacity Market, the DSR sector will benefit in the coming years from the following improvements to the electricity market:
- Smart meters roll out over the next ten years will provide the infrastructure to allow participation by a wider range of resources.
 - Ofgem's proposed reform to the cash-out arrangements, with prices currently proposed to rise to £6000/MWh, will itself provide a strong price signal for DSR.
 - Decarbonisation of the power sector will favour the use of DSR as a potentially lower cost option than low carbon new build.

Section 4.3.1: Specific procedures for DSR participation in the enduring Capacity Market

557. Any DSR resource can participate in the enduring capacity auctions from their launch in 2014. There are however, some specific procedures proposed for DSR capacity participating in the Capacity Market. This section explains these proposed procedures under six headings:
- a. DSR pre-qualification;
 - b. Credit cover requirements for DSR;
 - c. De-rating DSR;
 - d. Testing DSR;
 - e. Metering DSR; and
 - f. Baselineing DSR.

4.3.1.1 DSR pre-qualification

558. It is important – as with generation – that the Government and National Grid have confidence that DSR will be able to deliver when necessary. As such, there will be a pre-qualification process for DSR in advance of capacity auctions being held. The process must check all prospective resources have the same quality so can participate in the auction where the single selection criterion is price.
559. The Government proposes DSR will have two pre-qualification routes:
- (a) existing DSR: Resources must demonstrate their existing capability, either by undergoing testing or by submitting evidence of previous performance (similar to pre-qualification for existing generation); or
 - (b) prospective DSR: Resources must demonstrate their potential capacity by providing a defined list of meter point administration numbers (MPAN numbers) or a business plan, supported by a bid bond (similar to pre-qualification for new generation).

Route (a): existing DSR

560. DSR providers pre-qualifying under route (a) will be required to demonstrate their capability by either passing a test during the pre-qualification process or for example by reference to previous performance delivering a balancing service (including the Demand Side Balancing Reserve (DSBR) if run – see Box 4.22), the transitional arrangements or during a previous Capacity Market stress event or test.
561. This previous performance must have been with the same resources within the last two years and have demonstrated delivery of the stated capacity for at least one half hour settlement period. Any resources that have been substituted or added since the last demonstration must be tested separately or must qualify as a separate CMU under route (b).

Route (b): prospective DSR

562. A potential provider wishing to pre-qualify under route (b) would be required to either:
- provide a list of MPAN numbers that it intends to include in its portfolio (but is presumably unable to dispatch yet); or

- provide a business plan detailing how the demand resource required to meet the capacity offering would be built up.

563. All DSR would be required to provide the information set out below. In the case of DSR pre-qualifying through route (a) this must happen during pre-qualification (i.e. before the auction) to allow testing to take place or to demonstrate compliance with a balancing service contract. Under route (b) this information can be provided after the auction in line with the requirements below. This information is to allow baselining and measurement of performance during a system stress event and also to allow for effective review of the policy and how the DSR industry is functioning.

564. This information required must include:

- the amount of capacity to be bid into the auction;
- a list of the MPAN numbers from which the demand reduction or generation will be visible, to allow National Grid to ensure that a single demand resource is not included in multiple portfolios, and allow monitoring of delivery;
- the metering arrangements at each site and details of other meters that serve the site – this allows checks to be carried out to ensure demand is actually being reduced and not shifting between meters during a stress event.
- information on the type of resource – load reduction (reducing electricity demand from a baseline level), embedded storage (storage on-site or attached to the distribution network) or embedded generation (generation on site or attached to the distribution network); and
- a description of the business model of the provider (e.g. large industrial user or third party aggregator).

4.3.1.2 Credit cover requirements for DSR

565. No credit cover will be required from existing DSR under pre-qualification route (a). Where DSR providers are pre-qualifying under route (b) they will be required to provide credit cover (a bid bond) to ensure there is an incentive to give accurate and realistic information and to test their intention to deliver. This will be in the form of a bid bond set at £4,420 per MW¹²². This value aims to strike a balance between ensuring providers have a robust incentive to make realistic predictions while not presenting a significant barrier to entry. The Government is considering whether the credit requirement will be applied in respect of the 2014 capacity auction or from a later date.

¹²² For further information on this and the background analysis, please see the Expert Group paper on DSR from 9th July available at <https://www.gov.uk/government/policy-advisory-groups/114#meeting-papers>

566. National Grid will inform the settlement body that a prospective customer response CMU (see Section 4.8 for a description of the different types of CMU) has applied for pre-qualification and the settlement body (or the settlement agent) will calculate the bid bond required and request it from the DSR provider. The bid bond must then be paid to the settlement body at least a week before the auction. The settlement body will inform National Grid that the bid bond has been received thereby allowing that prospective CMU to pre-qualify.
567. The forms that DSR bid bonds can take will match the credit arrangements set out in the Connection and Use of System Code (CUSC) in Section 2, 'Connection', and Section 3, 'Use of System':
- a qualifying guarantee; and/or
 - a letter of credit (available for an initial period of not less than 6 months); and/or
 - cash for credit to the Escrow account; and/or
 - a bilateral insurance policy; and/or
 - an insurance performance bond; and/or
 - an independent security arrangement.
568. The bid bond will be held by the settlement body until one of the following triggers occur:
- (a) the auction takes place and the provider does not win an agreement or does not participate in the auction;
 - (b) the provider wins an agreement in the auction and subsequently proves capacity by passing a test (see below); or
 - (c) the provider wins an agreement and fails to pass a test within the allowed time.
569. Under (a) or (b) National Grid will inform the settlement body and the bond will be returned to the provider. Under (c) the bond is forfeit and surrendered to the Exchequer.
570. CMUs that entered the auction with unproven resources and are subsequently only able to provide part of the capacity for which they were awarded an agreement in the auction will have their obligation scaled down to the level of capacity they can provide. However it is proposed that they will lose their full bid bond if they fail to deliver. This is intended to act as a strong incentive to deliver.

4.3.1.3 De-rating DSR

571. DSR's nameplate capacity will be set by the maximum demand reduction achieved during the pre-qualification test – undertaken after the auction under pre-qualification route (b) – or previous performance delivering a balancing service. For DSR pre-qualifying under route (b), the amount of capacity for which a bid bond is placed will be deemed to be the 'nameplate' capacity of that CMU unit as declared in the business plan for the purposes of the auction. As with generation, the nameplate capacity will then be de-rated according to a central figure for the capacity type.

572. DSR will be de-rated by National Grid during pre-qualification, in line with other capacity providers.
573. As with all other prospective resources National Grid will apply a standard DSR de-rating factor rather than an individual de-rating factor being calculated for each prospective Customer Response CMU. De-rating factors will be based on the past performance of DSR within the balancing services market and the DSRB (if run). As information on DSR's reliability improves, the de-rating factor would be updated, for example using data gathered during the transitional arrangements.

4.3.1.4 Testing DSR

574. Testing is needed to ensure that DSR providers will be able to deliver capacity when needed. Tests will be triggered in the following ways:
- For DSR pre-qualifying under route (a): ahead of the pre-qualification window – to prove that the resource exists, allowing the DSR to pre-qualify and participate in the auction.
 - For DSR pre-qualifying under route (b): after the auction, once the resource has been built – to prove the new resource exists, allowing the bid bond to be returned and the resource to receive capacity payments.
 - For DSR pre-qualifying under both pre-qualification route (a) and (b): during the first half of the delivery year, either during the transitional arrangements or enduring Capacity Market, in the absence of stress events – to prove the capacity is still operational.
 - For DSR pre-qualifying under both route (a) and (b): in the second half of the delivery year – if the capacity fails to nominate itself for tests or fails to pass tests during the delivery year in line with its obligations (see 'Spot Testing' in Section 4.2.5).
575. Tests will check the control systems, processes for despatch, that a relationship exists between the provider and the resource that will reduce demand for electricity on the system, and that a reduction occurs at the time of the test.

4.3.1.5 Metering DSR

576. The meter level data for individual meters is not available to either Elexon or National Grid at a disaggregated level. There are therefore DSR resources for which existing metering is insufficient to pick up the complexities of energy use on the site. For example, where on-site generation (i.e. used to power a site) is not separately metered (i.e. behind the meter generation). In addition, if the generator is used to power the site most of the time – such as embedded CHP – there will be no notable drop in demand from the system at times of stress because the generator is continuing to power the site rather than only powering it during the stress event. The unit is still delivering its obligation at the time of stress because it is

continuing to power the site in the same way as a larger generator that runs as baseload plant (i.e. all or most of the time) and so metering is needed to reflect this capacity.

577. This means that monitoring of DSR and embedded resources cannot take place without changes to existing BSC systems and processes that would allow the data to reach the settlement agent. However there will be several options (set out below) for metering the resource.
578. The DSR capacity provider must declare during pre-qualification how metering will be carried out and it will also be the responsibility of providers to ensure the metering of their units provides the settlement agent with the necessary data to assess their delivery. Where data is not provided when required, the unit will be deemed to have failed to deliver during the event or test.

DSR metering option (a)

579. The DSR capacity provider must notify the data collector (appointed by the supplier) to pass the half hourly, non-aggregated BSC metered data for the relevant CMU component (and related meters on the same site if appropriate) to the settlement agent. This option is for either DSR, embedded generation that exports electricity to the network, or embedded generation which has a separate BSC meter.

DSR metering option (b)

580. The DSR capacity provider must put metering in place to measure delivery and provide the data to the settlement agent.

DSR metering option (c)

581. The DSR capacity provider must arrange through the relevant supplier to register an additional BM Unit (BMU) and assign only the metering systems associated with that CMU to the additional BMU¹²³. Additional BMUs can take in multiple sites, allowing aggregation of metering for DSR resources with the same supplier. This is most likely to be appropriate for larger embedded generation, but is a permissible alternative for any provider that could also use DSR metering option (a).

DSR metering option (d)

¹²³ Balancing Mechanism Unit - units of trade within the Balancing Mechanism. Each BM Unit accounts for a collection of plant and/or apparatus, and is considered the smallest grouping that can be independently controlled. <http://www.elxon.co.uk/reference/technical-operations/balancing-mechanism-units/>

582. DSR capacity providers who also participate in STOR can use the existing STOR metering. This is likely to be the case for example for embedded generation where the only data requirements are to show output at times of system stress or during a test.

4.3.1.6 Baseline DSR

583. For all CDR CMUs, it is proposed that consumption of electricity during a system stress event will be compared to consumption at other, similar times to determine whether a DSR provider has delivered its obligation. This involves measuring performance during similar periods and then comparing these. For example performance measured during seven days of similar conditions with the test that delivery is met in five or more of those seven days would mean a 'five of seven' test. This is known as an 'X of Y' method.
584. Considering a single settlement period, baseline consumption would be calculated from:
- Demand in the same settlement period on the same day of the week for the last six weeks, giving six samples of day of the week and time of day.
 - Demand in the corresponding settlement period one year before and the demand in the settlement period one week earlier and later (i.e. 53 and 51 weeks before the stress event), giving a further three samples which capture time of year.
 - Demand in the same settlement period on 10 of the previous 14 days, to capture ongoing consumption and to mitigate incentive to inflate demand for a short period to increase potential reduction.
 - Anomalous days (such as non-working days like Christmas Day) would be removed from the sample. Data samples should be corrected to reflect delivery of a contracted balancing service and additional rules may need to be devised in future for providers that have entered the Electricity Demand Reduction programme.
585. The Government proposes that monitoring should be carried out to confirm that there has been no baseline manipulation. Where demand reduction is delivered through some but not all of the MPANs at a given site, the data for all MPANs at the site would be examined to determine that a genuine demand reduction has been delivered.
586. DSR capacity providers will be able to take on balancing services obligations (such as STOR) as well as capacity obligations, with the exception of the DSBR if run. If responding to an instruction for a contracted balancing service, the unit's baseline or delivery during the event may have reduced, appearing as an under delivery of the capacity obligation. To avoid penalising units for participation in both the capacity and balancing services markets, baselines and delivery will be adjusted by the settlement agent where delivery of a balancing service would have affected delivery of the unit's Capacity Market obligation.

587. Some units also respond to signals in the market (e.g. TRIAD avoidance or high prices)¹²⁴. This is considered to be 'business as usual' and the Capacity Market obligation will not be reduced to reflect actions outside the balancing services.

Box 4.20: Most relevant sections of the draft instruments that relates to this section

Regulations:

5. Part 4: Capacity auctions
 - i. Chapter 3: Eligibility criteria
 - ii. Chapter 4: Determining eligibility and holding capacity auctions
 - iii. Chapter 5: DSR transitional auctions

Capacity Market Rules:

- Chapter 3: Prequalification information
- Chapter 4: Determination of eligibility
- Chapter 10: Transitional arrangements

Box 4.21: Consultation questions:

Specific procedures for DSR participation

Question CM43	<ul style="list-style-type: none"> • Do you agree that the specific rules for DSR (i.e. the proposals on bid bonds, eligibility, baselining, metering) are justified and provide DSR with a reasonable opportunity to participate? Are any other features needed (and if so why?)
Question CM44	<ul style="list-style-type: none"> • Is the proposed level of the bid bond (£4,420/MW) for prospective DSR appropriate to sufficiently incentivise delivery without presenting an unacceptable barrier to entry?
Question CM45	<ul style="list-style-type: none"> • What do you think of the proposal that failure to deliver the total capacity awarded in the auction should result in the forfeit of the total bid bond? Does this provide a comparable incentive for prospective DSR to deliver when compared to the incentives for new generation to deliver?
Question CM46	<ul style="list-style-type: none"> • Do you have any further comments on aspects of the design described in this section?

¹²⁴ National Grid's methodology for this may be found here: <http://www.nationalgrid.com/NR/rdonlyres/4E151C89-929C-4D56-B18D-ABD6596CFAE0/43449/Triadcalculationmethodology1.pdf>

Question CM47

- Do you have any comments on Chapters 3, 4 and 5 in Part 4 of the regulations and Chapters 3, 4 and 10 of the Capacity Rules on the eligibility and pre-qualification arrangements for DSR?

Section 4.3.2: Transitional arrangements for DSR

588. The Government proposes transitional arrangements to provide the nascent DSR sector with a pathway towards the main Capacity Market. Certain features and requirements of the main Capacity Market will be relaxed under these arrangements. The transitional arrangements are designed to limit risk, to encourage enterprise and to build confidence. The programme will be time limited and progressive and will include periodic reviews to improve understanding of the performance, role and potential of the DSR sector.
589. National Grid is exploring the development and procurement of two new balancing services, referred to as 'Demand Side Balancing Reserve' (DSBR) and 'Supplemental Balancing Reserve' (SBR).

Box 4.22: Demand Side Balancing Reserve (DSBR)

- For the DSBR product currently proposed, National Grid would procure a quantity of demand reduction capability at peak times on non-holiday weekdays in the months of November to February inclusive. The intention is to stimulate the development of new demand-side resources by providing a simple, low cost solution, allowing consumers or their agents to offer demand reduction services directly to National Grid.
- National Grid is currently consulting on these proposals and is expected to conclude this process in the autumn. National Grid would require Ofgem's approval before it could procure these reserves. In line with the process for approving new balancing services it is expected that any GEMA decision will be made in November at the earliest.

590. The Government expects to introduce the transitional arrangements with a first auction in 2015. Two years of DSR transitional arrangements should provide sufficient preparatory experience for the industry.
591. In addition, should National Grid recommend to Ofgem the introduction of DSBR and this is approved by the regulator, the learning from these arrangements should help support DSR participation in the subsequent Stage 1 transitional arrangements auctions.

4.3.2.1 Timing for DSR transitional arrangements

592. The Government envisages two stages of transitional arrangements, each of two years' duration. Stage 1 (delivery years 2016/17 and 2017/18) will introduce DSR specific auctions for load following and time limited obligations i.e. limited to peak hours and days. Government proposes to run stage 1 auctions in autumn 2015 and autumn 2016 for delivery in 2016/17 and 2017/18 respectively.
593. At the end of stage 1, the Government will carry out a review and set out the terms of stage 2 (if any). Stage 2 would endure for no longer than 2 delivery years (i.e. 2019/20 and 2020/21) bringing the transitional arrangements to an end by 30 September 2021 at the latest. Figure 4.13 sets out the proposed timing of the DSR transitional arrangements.

4.3.2.2 Eligibility for DSR transitional arrangements

594. National Grid will provide an assessment of the likely amount of DSR that will be available for each delivery year. This analysis will be presented to the Government in the form of a draft demand curve for each auction which the Government must approve.
595. Since the purpose of the transitional arrangements is to support nascent participants, the Government proposes to limit eligibility to non-CMRS CMU's and CDR CMUs which have not participated in the Capacity Market or in the Balancing Mechanism and include generation no larger than 50MW.¹²⁵
596. Participants in the transitional arrangements will be free to participate in other services such as TRIAD avoidance and National Grid's balancing services. The baseline for delivery will be adjusted to take account of delivery under contracted balancing services (as with generation), but not for TRIAD avoidance so a provider would have to make a commercial decision about participating in both TRIAD avoidance and the Capacity Market.

4.3.2.3 Pre-qualification for DSR transitional arrangements

597. The Government proposes that pre-qualification for the transitional arrangements should be the same as in the enduring Capacity Market with one exception: the level of the required bid bond will be reduced by 90% to £442/MW. This reflects the relatively underdeveloped nature of the DSR market.

¹²⁵ See Section 4.8 for a description of different CMU types.

Figure 4.13: Indicative schedule of DSR transitional arrangements

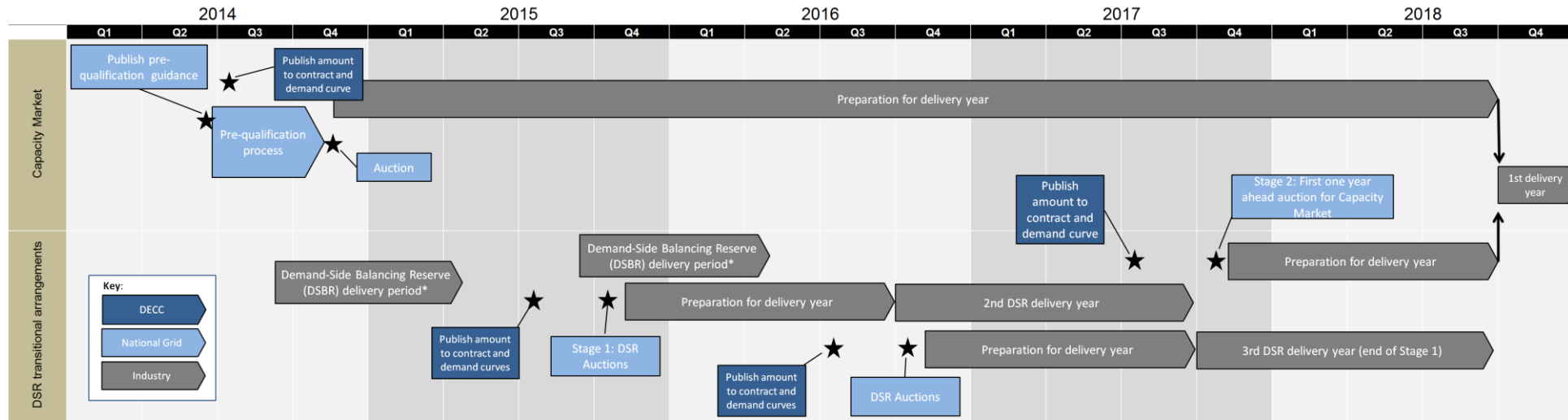

*Note: National Grid will only look to procure these services if they are approved by Ofgem and are considered necessary to balance the system. See Ofgem's separate consultation for more detail.

4.3.2.4 Products to be auctioned in the DSR transitional arrangements

598. National Grid will hold year ahead auctions using the same format as the main Capacity Market. There will be two auctions each year, the first for the load following obligation, the second for the time banded products.
599. The demand curves for each auction will set out the quantities of each product demanded. The obligations to be procured are:
- winter weekdays 9am-11am and 3pm-7pm (time limited obligation); and
 - load-following obligation (as in the enduring Capacity Market).
600. We expect the relative proportion of time limited obligations to reduce in future auctions in line with a goal for all Capacity Market resources to have load following obligations.

4.3.2.5 Penalties and testing in the DSR transitional arrangements

601. The Government proposes penalties in the transitional arrangements should be softer than those in the enduring Capacity Market to limit providers' risk exposure and encourage participation. The penalty formulation will be the same as in the enduring Capacity Market. The amount a provider can lose in the transitional arrangements will be capped at 100% of its annual capacity payment to ensure a provider cannot lose more than its annual payments.
602. Where stress events occur, National Grid will despatch DSR (i.e. instruct it to reduce demand) four hours in advance (in line with the enduring Capacity Market's Capacity Market warnings) and monitor providers' performance. Where stress events do not occur, providers will be tested. There will be up to five tests a year, with every scarcity event that occurs reducing the number of tests carried out. A provider should therefore expect to be despatched a minimum of five times a year.
603. Requirements to deliver and penalties for failing to respond will be the same whether DSR is despatched for a stress event or for testing. These tests are separate to the test undertaken to prove the capacity exists in the first instance that form part of pre-qualification. The cap will prevent providers losing more than their annual payment if a large number of scarcity events occur and they fail to respond to them.
604. When despatching for tests, to limit impacts on the electricity market National Grid will not despatch all DSR providers simultaneously. National Grid will not begin issuing Capacity Market warnings until the first delivery year for the main Capacity Market commences in October 2018, so National Grid will use alternative despatch methods. Despatch will be carried out by existing systems where providers have access to those systems or manually by National Grid for DSR units which are not party to any of those systems. The despatch systems used by balancing services could be used to despatch DSR if relevant.

4.3.2.6 Recovery of costs for the DSR transitional arrangements

605. The costs of capacity payments and settlement in the transitional arrangements will be met by electricity suppliers, with costs allocated in the same way as in the main Capacity Market.

4.3.2.7 Review of the DSR transitional arrangements

606. The size and composition of the DSR sector is not well understood at present and one of the objectives of the transitional arrangements is to gain insight into the industry. The Government proposes reviews to cover issues such as:
- The composition of DSR in GB and how the sector changes over time.
 - How the DSR sector responds to the transitional arrangements and the changes to the industry that result.
 - The readiness of the DSR sector to move onto the same terms as other capacity providers in the Capacity Market.
607. Ofgem and National Grid will produce reports on the transitional arrangements which the Government will use to inform decisions on the future of the arrangements.
608. To bring in the rules for stage 2 in time for the first year ahead auction of the Capacity Market, initial decisions will need to be made on the basis of the 2015 auction and 2016/17 delivery year. The review in 2016 will help inform whether stage 2 is required. The Government will take the decision to introduce stage 2 based on the extent to which the DSR sector has developed and can compete in the enduring Capacity Market.

4.3.2.8 Stage 2 of the DSR transitional arrangements

609. Stage 2, if required, will be designed following the review carried out during stage 1 of the arrangements. Stage 2 would run alongside the first year ahead auction in the Capacity Market in 2017.
610. Stage 2 of the arrangements should require a move by DSR towards the requirements of the enduring Capacity Market. It is likely, for example, that the arrangements would remove the time banded products and all DSR would be required to take on a load following obligation. Penalties could remain less onerous than in the main Capacity Market, however, with either lower event penalties or a lower cap.

Box 4.23: Most relevant sections of the draft instruments that relate to this section

Regulations:

- Part 4: Capacity auctions
 - iv. Chapter 5: DSR transitional auctions

Capacity Market Rules:

- Chapter 10: Transitional arrangements

Box 4.24: Consultation questions: DSR transitional arrangements	
Question CM48	<ul style="list-style-type: none"> • Do you agree with the necessity of transitional arrangements to help build the capability of the DSR sector?
Question CM49	<ul style="list-style-type: none"> • What are your views on the proposed transitional arrangements and do you think they will prove effective i.e. over 2 time limited stages and with the parameters set out?
Question CM50	<ul style="list-style-type: none"> • Do you agree that the level of the bid bond should be reduced by 90% for prospective DSR during the transition period?
Question CM51	<ul style="list-style-type: none"> • Do you have any further comments on aspects of the design described in this section?
Question CM52	<ul style="list-style-type: none"> • Do you have any comments on Chapter 5 in Part 4 of the regulations and Chapter 10 of the Capacity Market Rules on the transitional arrangements?

Section 4.4: Payment model

611. This section includes a detailed description of the Capacity Market payment model. It will cover how the Capacity Market will be funded, and set out the roles, functions and governance arrangements of the key institutions within the payment model.

Section 4.4.1: Payment model overview

612. Capacity providers that have been successful in the auction will receive capacity payments in the relevant delivery year. These capacity payments will be known in aggregate following the auction, and so well in advance of the delivery year. The payments will be funded by a compulsory payment payable by all licenced suppliers (referred to in this document as the 'levy'), the details of which will be set out in regulations. The levy will be calculated so that is shared amongst suppliers based on suppliers' share of the market at times of peak demand – this will initially be based on suppliers' forecasts of their market share and then reconciled as accurate data becomes available.
613. As set out previously, capacity providers will be subject to penalties should any under-perform against their capacity obligations during a stress event, or over delivery payments should they over-perform. The payment model also sets out how these penalty payments will be collected and redistributed as over delivery payments. The levy and penalties/over delivery payments will be administered by a settlement body and a settlement agent. The settlement body's and settlement agent's running costs will also be funded via a charge on licenced suppliers.

Figure 4.14: Overview of Capacity Market payment flows

614. To provide ultimate accountability, governance and control of the monies collected and dispersed under the payment regulations, which we expect to be a tax, a public body must carry out certain functions under the payment model. The Government intends to set up a new private company limited by shares, established and wholly owned by Secretary of State to act as the settlement body. It will mirror where practical the set-up of the counterparty, which is described in Chapter 3 of this consultation document. The Government's intention is to use, where possible, synergies between the Capacity Market settlement body and counterparty to minimise operational costs and simplify processes for CfD and Capacity Market participants.
615. The Capacity Market Settlement Agent, Elexon, will perform the majority of day-to-day operational activities relating to Capacity Market settlement, such as calculation of payments and charges, collecting data from participants and enforcing non-payment and charges. Functions may be conferred directly on the settlement agent through regulation or through a contract between the settlement body and settlement agent.

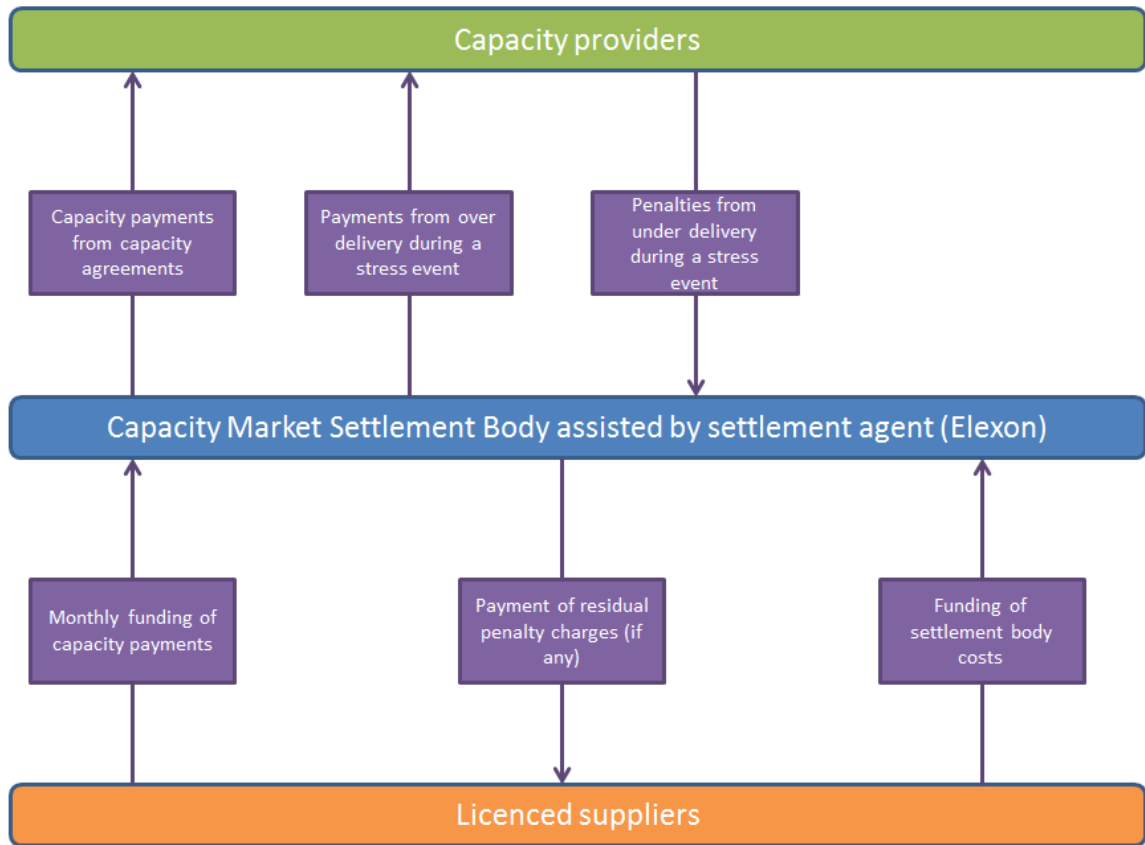

616. A number of specific activities have been identified with regard to the settlement of the Capacity Market. A summary of each of the activities is set out in Figure 4.15 below.

Figure 4.15: Activities of the Capacity Market Settlement Body and Capacity Market Settlement Agent

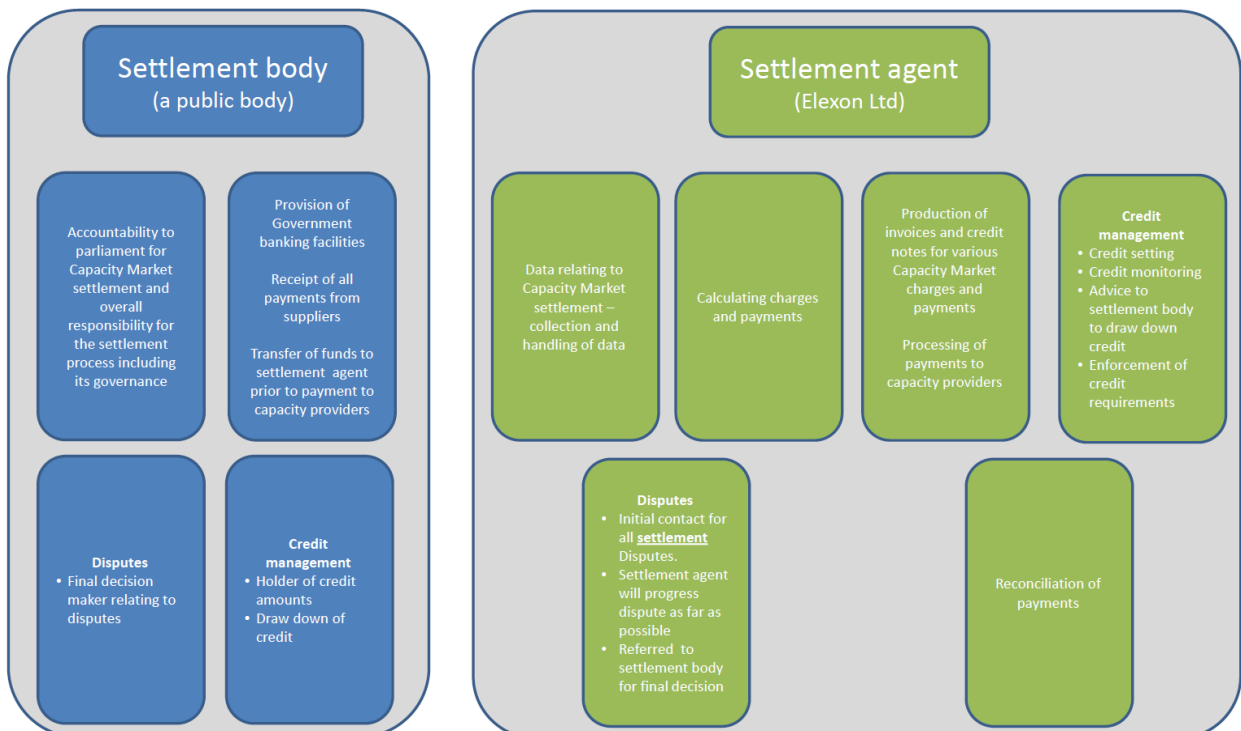

617. Further details on the respective roles of the settlement body and agent and the governance arrangements are provided later in this chapter.

Section 4.4.2: Calculating charges and payments

618. There are a number of different payments which apply to licenced suppliers, capacity providers and portfolio adjustment payers (see Box 4.17 in Section 4.2.5) in respect of the Capacity Market. These are as follows:
- **Capacity Market supplier charge**
A payment made by licenced suppliers to pay for the total amount of capacity obligations of capacity providers. The amount paid by a licenced supplier is in proportion to its share of the electricity market at the time of system peak demand.
 - **Capacity provider payment**
A payment to a capacity provider in respect of the capacity obligations held by the provider.
 - **Capacity provider penalty charges**
A payment made by a capacity provider and/or a portfolio adjustment payer for any under-performance against its capacity obligations during a stress event.
 - **Capacity provider over delivery payment**
A payment to a capacity provider for any over-performance against its capacity obligations during a stress event.
 - **Penalty residual supplier amount**
The difference between the total of capacity provider penalty charges, less total amounts paid in over delivery payments, for a given month. This difference, where it is not zero, is a payment made to licenced suppliers.
 - **Settlement body costs**
A payment will be made by licenced suppliers to pay for the costs of the settlement body and the settlement agent in discharging the functions conferred by regulations.
619. All of these payments will be made through the settlement body. It is intended that payments made to the settlement body each month will equal payments made by the settlement body. The settlement body will not therefore carry a positive or negative cash balance from month to month.
620. Funding for payments to capacity providers is done on a 'pay when paid' basis by the settlement body. There are robust safeguards built into the Capacity Market payment model to ensure certainty of payments for capacity providers. These include payment in arrears, credit cover, for and the ability to enforce payment through licence conditions, and the ability to mutualise the charges of a defaulting supplier across the remaining suppliers. The Government considers that these arrangements ensure that the funding for payments to capacity providers is robust in all credible scenarios. In the unlikely event that there is a funding shortfall in a billing period then there will be a pro-rata reduction in all payments to capacity providers for that billing period. Should the shortfall be recovered at a later date then previous payment reductions will be reversed through reconciliation.

4.4.2.1 Capacity Market supplier charge

621. The Capacity Market supplier charge is first calculated annually. The Government intends that once the amount to be recovered from suppliers is known this shall be published each year as an amendment to the payment regulations. The proportion of the annual amount payable by a particular licenced supplier is determined by reference to that supplier's market share at the time of system peak demand.
622. Market share at the time of system peak demand will initially be calculated by the settlement agent based upon a forecast collected from licenced suppliers not less than three months prior to the start of the delivery year. This forecast will be of the average electrical demand that the supplier expects its customers will be drawing across the three TRIAD peak periods of the delivery year. The forecasts provided by all suppliers shall be used by the settlement agent to determine each supplier's market share and therefore the size of each supplier's Capacity Market supplier charge.
623. The contribution of DSR CMUs to a supplier's demand could lead to 'double benefits' accruing, as the supplier's metered demand could suggest a lower market share due to the reductions achieved through DSR CMUs. This would lead to benefits accruing to both the DSR provider directly through the Capacity Market, and to the supplier through lower funding charges. The Government is therefore considering whether the contribution of any DSR CMUs to reducing a supplier's demand should be removed from the calculation of each supplier's market share. However, the Government recognises that this could be a complex process to administer and so invites comments from consultation respondents both on whether the output of DSR CMUs should be removed from suppliers' market share calculations, and if so on the most appropriate method to achieve this.
624. The Government has selected the peak charging method for consultation for two main reasons. First, the amount of capacity purchased through the capacity auctions is directly linked to peak demand. Thus by linking charges to peak demand there is a clear incentive for parties to reduce peak demand, which reduces the overall amount of capacity that needs to be procured and reduces costs to consumers. Second, such a charging method offers further opportunity for demand side response to help manage any shortages of capacity where otherwise it may not have been able to contribute. This would be through DSR providers that cannot provide a year-round service directly in the Capacity Market contracting directly with the supplier (outside the Capacity Market) to reduce the supplier's charges over the TRIAD periods. By reducing demand over the TRIAD periods in this way, the amount of capacity that needs to be procured through the Capacity Market could, in time, be reduced.
625. As the peak charging method sets charges based upon a short period of the year it is less able to reflect year round changes in supplier and customer behaviour. The Government is therefore interested in views on alternative approaches as part of the consultation.

Box 4.25: Most relevant sections of the draft instruments that relate to this section

Payment regulations:

- Chapter 5: Capacity market calculations
- Chapter 6: Determinations and invoicing
- Chapter 7: Payment and non payment

Box 4.26: Consultation questions:**Payment model: calculating charges and payments**

Question CM53	<ul style="list-style-type: none"> • Do you have any comments on the charges being calculated for the purposes of Capacity Market settlement?
Question CM54	<ul style="list-style-type: none"> • Given the Government's objective to link the costs of the Capacity Market with the drivers of those costs, and the desire to facilitate demand side participation in the Capacity Market, are you aware of an alternative to the peak charging methodology that might better meet those objectives?
Question CM55	<ul style="list-style-type: none"> • Do you believe that any contribution from DSR CMUs should be excluded from suppliers' market share calculations, and if so what is the best method of doing this?
Question CM56	<ul style="list-style-type: none"> • Do you have any comments on Chapters 5, 6 and 7 of the payment regulations covering calculating charges and payments?

Section 4.4.3: Data systems and data collection

626. The settlement agent shall be responsible for the set-up and maintenance of systems that allow it to collect and securely store, and where appropriate securely transmit, the data necessary for the settlement of the Capacity Market.
627. The settlement agent will be responsible for collecting data from:
- The Balancing and Settlement Code Company (BSCCo);
 - National Grid;
 - Suppliers;
 - Capacity providers that are not parties to the Balancing and Settlement Code or that do not provide data under the Balancing and Settlement Code; and
 - Ofgem.

628. Regulations have been drafted to oblige each of these parties to provide relevant data to the settlement agent. The Government's proposals as to the precise data requirements for each party are set out in the draft regulations accompanying this consultation.

Box 4.27: Most relevant sections of the draft instruments that relate to this section

Payment regulations:

- Chapter 4: Provision of data

Box 4.28: Consultation questions:

Payment model: Data systems and data collection

Question CM57

- Do you have any comments on the data to be collected for the purposes of Capacity Market settlement (including whether all appropriate data flows been captured accurately)?

Question CM58

- Do you have any comments on Chapter 4 of the payment regulations on the provision of data?

Section 4.4.4: Invoicing, banking and payment

629. The invoicing, banking and payment process will involve collaboration between the settlement body and the settlement agent.
630. The settlement agent will be responsible for the calculation and preparation of invoices, while the settlement body will have control over the banking arrangements for the Capacity Market, with the settlement body receiving all payments due from suppliers and capacity providers and releasing payments to capacity providers in line with the settlement agent's calculations.
631. The Government proposes to align the Capacity Market settlement timetable with the availability of data in the BSC settlement process, as many of the calculations required are heavily dependent on such BSC data. The timetable is structured such that monies to be received by the settlement body are invoiced and collected prior to the issue of credit notes and payments out from the settlement body. This allows credit to be drawn down and used to fund payments in the event of non-payment. Where liabilities are unsecured (penalty payments), the settlement timetable allows later payment amounts to be amended so as to recover any underpayments and to reflect non-payments.
632. The Government is aware there may be a potential inconsistency between disputes following a stress event and the proposed settlement timetable (as set out in Figure 4.16) – particularly where the timetable requires monies to be collected and paid before potential disputes have been resolved. For this reason the Government is considering whether the calculation and

invoicing/payment of any penalty charges or over delivery payments should be delayed to allow disputes to be resolved. This would seek to avoid the scenario where parties having received payments are required to return them potentially months later after the resolution of a dispute. Although such a proposal is not contained within the draft regulations at this stage, views on such an approach are invited from consultation respondents.

633. All amounts owed will be invoiced separately to allow a clear separation between cost categories, and where the consequences of default differ between payments, to allow the consequences of such a default to be clearly and unambiguously identified. Further detail may be found in the accompanying draft regulations.

4.4.4.1 Settlement body costs

634. The settlement body will be required to forecast its operational costs in advance of each Capacity Market delivery year such that this forecast may form the basis of the operational costs levy that is to be charged to suppliers (the 'Settlement body charge'). This charge will be apportioned between suppliers based on their overall Capacity Market funding share, which is based on their customer's share of TRIAD peak demand as described in further detail below.
635. The settlement body will be required to maintain strict control of its operational costs and will where possible exploit synergies with the counterparty. It must set and adhere to an annual budget covering its costs in connection with its role as the Capacity Market settlement body for the forthcoming delivery year. The annual budget will also set out the forecast costs of the settlement agent in performing functions conferred on it under the regulations.
636. The settlement body will be required to seek representations from licenced suppliers and other interested parties about its forecast costs in the form of a draft forecast budget. This will commence in September in the calendar year prior to the capacity year for which the costs are forecast and suppliers and other parties will have between four to six weeks to reply. The settlement body will be required to consider the responses. This requirement to provide a forecast budget and to seek representations applies in respect of the capacity year commencing 1 October 2016 and each subsequent capacity year. We are considering the implications of moving the payment year for the settlement body costs from the Capacity Market year to the financial year.
637. By 30 November prior to the capacity year to which the forecast costs relate, the settlement body must present its forecast budget to the Secretary of State for approval. The Secretary of State may within two months of receipt of the forecast budget require amendments to it. The settlement body costs included in an approved budget are recoverable from licenced suppliers. The Government intends that once the amount to be recovered from suppliers is known this shall be published each year as an amendment to the payment regulations.

638. The Government will have oversight of whether the settlement body is likely to over or under collect. In the event of an under collection and to ensure the settlement body's continuation, the Government may need to provide working capital and/or top up the budget, or in extreme cases, seek to amend the levy mid-year. The Government is considering the implications of any over recovery of costs, and how/whether these should be returned to suppliers.
639. Reconciliations of settlement body charges will only occur at the initial settlement (SF) run mirroring Elexon's approach to recovering its own running costs under the BSC arrangements.¹²⁶ The level of accuracy is high and reconciling data for 14 months as under the main Capacity Market charge (see below) is arguably not required for the relatively small amount of money involved. The settlement body will not be able to accrue the levy beyond the point at which it finalises its annual accounts, so we consider this to be an appropriate cut-off point for data reconciliation.
640. The settlement body will issue invoices each month of a capacity year in respect of the settlement costs included in the approved budget. It is proposed that the annual budget will (normally) be recovered from suppliers in 12 equal monthly instalments, based on their overall Capacity Market funding share. However, where as part of setting the final budget the settlement body is able to demonstrate that costs will be incurred with a degree of non-uniformity throughout the year, the monthly amount of settlement costs recoverable for licenced suppliers may vary accordingly.
641. At the end of each delivery year the settlement body will be responsible for preparing an annual report and accounts setting out a review of its Capacity Market settlement activities (and those of its agent) and incorporating its final audited accounts for the delivery year in question. This report will include a breakdown of its expenditure against budget, detailing areas of significant under- or over-spend. The annual report and accounts will be presented to the Secretary of State and published such that all Capacity Market participants may be able to review it. This shall be done not less than four months following the end of the delivery year for which the annual report and accounts refers.
642. The exact timetable which the settlement body must follow with regard to recovering its operational costs is subject to further work and may be set out either in regulations or the company's constitutional documents.

Figure 4.16: Capacity Market settlement timetable

Note: related settlement payment flows are colour coded. For example green colour coded payments from supplier monthly charges (together with any credit drawn down) fund capacity provider payments)

¹²⁶ 'Initial settlement (SF)' is defined in the Balancing and Settlement Code payment timetable.

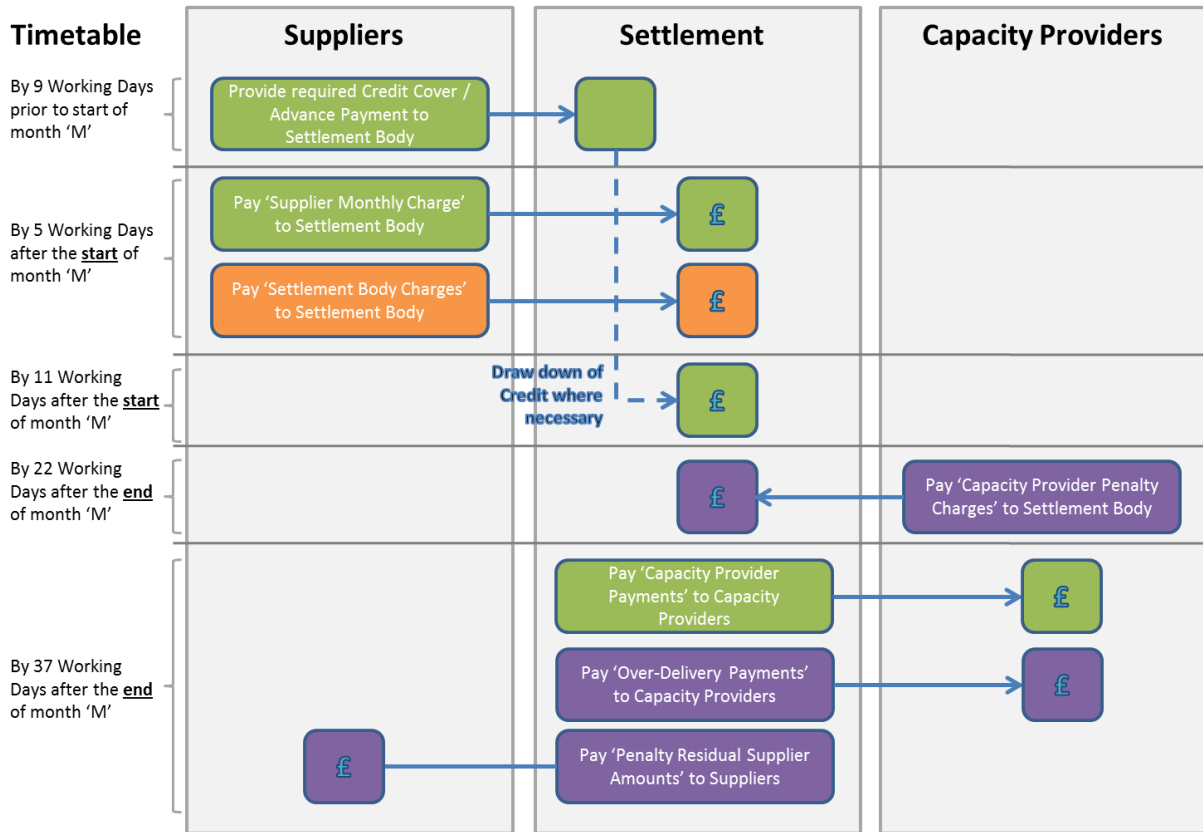

Box 4.29: Most relevant sections of the draft instruments that relate to this section

Payment regulations:

- Chapter 6: Determinations and invoicing
- Chapter 7: Payment and non-payment

Box 4.30: Consultation questions:

Payment model: invoicing, banking and payment 1

Question CM59	<ul style="list-style-type: none"> • Do you have any comments on the settlement timetable?
Question CM60	<ul style="list-style-type: none"> • Do you have any views on the proposal to delay payment of penalties and over delivery payments pending the outcome of any disputes?
Question CM61	<ul style="list-style-type: none"> • Do you think sufficient time is allowed for payments to be made once invoiced, given the fact that a forecast of monthly costs will have been provided in advance of the delivery year as part of the credit cover process?

Question CM62	<ul style="list-style-type: none"> Do you have any comments on the differences between payment timings proposed within the Capacity Market and those proposed for CfDs?
Question CM63	<ul style="list-style-type: none"> Do you have any comments on Chapters 6 and 7 of the payment regulations regarding invoicing, banking and payment?

4.4.4.2 Identification and Monitoring of credit cover

Suppliers

643. Suppliers will be required to lodge credit cover with the settlement body so that they are in a position to cover their Capacity Market supplier obligation and settlement body charge payment obligation for one month in the event of default.
644. Credit cover is required for each month, but as each month's credit requirement does not overlap with the following month's, suppliers may choose to have credit cover in place which applies to more than one month. The settlement agent will calculate the amount of a supplier's credit cover for each month at the total of the monthly supplier charge and the monthly settlement costs requirement, plus and an additional headroom of 10%. In the event that a supplier has not supplied sufficient credit cover and is in credit default, defaulting supplier's charges are mutualised across other suppliers. The 10% headroom intended to ensure that the remaining suppliers have sufficient credit to cover their increased funding share following any mutualisation in the event that it occurs.
645. The settlement body shall be responsible for ensuring that credit cover is provided throughout the period for which it is required. The exact process by which this is managed is set out in the accompanying draft regulations.
646. The Government notes that as the supplier credit cover amounts and their monthly payments are initially based upon demand forecasts provided by suppliers before TRIADs have been confirmed there may be an incentive to influence those forecasts to reduce the volumes of credit cover required. The Government is considering whether additional controls or verification of suppliers' demand forecasts are required. Although such controls are not included in the draft regulations being consulted upon at this stage, respondents' views are welcomed on this issue.
647. The draft regulations require 100% of credit cover to be in place before the start of a given month else all of a supplier's outstanding charges will be mutualised. At this point Ofgem may consider whether the terms of the supplier's supply licence have been breached. Mutualisation is need in order to provide certainty to investors that in the event of a default in providing credit cover by a supplier, the default will not result in a funding shortfall for payments to capacity providers. The Government is interested in respondents' views on

whether this is appropriate or if alternatives, such as a lower threshold for mutualisation (e.g. failure to provide 85% of the required credit cover) or a system of partial mutualisation with only the charges represented by the shortfall in credit cover being mutualised.

Figure 4.17: Sample Credit Cover Timetable

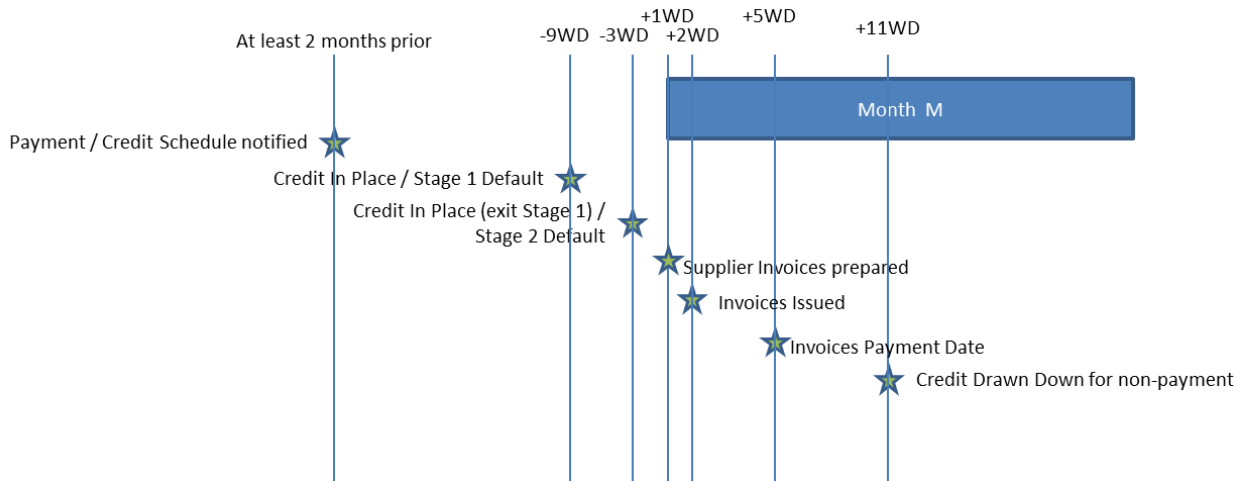

Capacity Providers

648. Existing capacity providers will not generally be required to lodge any credit cover with the settlement body. Cover for any penalty default will be provided by netting against future capacity revenues in the first instance. This netting off will continue until such time as the capacity provider ceases to have a capacity agreement. Any defaulted penalty amounts outstanding at this point will be mutualised across Suppliers, and addressed with the defaulting Capacity Provider via Ofgem's licence breach arrangements where these are applicable. The only requirements for a capacity provider to provide credit cover would be a bid bond for a DSR provider (see Section 4.3) or against any termination fees that are required to be paid by new plants (see Section 4.2 for further details).

4.4.4.3 Requirements for credit cover

649. The following forms of credit only may be accepted as valid credit cover:
- a letter of credit from a bank with a long term debt rating of not less than A3 by Moody's or A- by Standard & Poor's; or
 - cash in an escrow account (as set out in regulations).
650. The forms of collateral allowed as credit cover against these charges are intentionally different and more restricted than the forms of collateral permitted as security against termination fees or bid bonds, as in this case the requirement for payment is more urgent and critical. It is necessary for the credit cover to be in a form which can be drawn upon quickly if a supplier charge is not paid on time, in order to ensure that the settlement body remains able to make capacity payments in full and on time.

4.4.4.4 Default and mutualisation

651. Suppliers must ensure that they have approved credit cover in place prior to the start of each month. Where they do not have this in place nine working days prior to the start of the month they enter stage one credit default. They will then be given a further three business days to provide sufficient credit cover. Should they fail to do so the supplier will pass into stage two credit default. At this point their outstanding charges will be mutualised. The suppliers whose charges increase will be notified in accordance with the normal timetable (within three business days).
652. Mutualisation is where any monies which would otherwise be paid by a supplier in stage two credit default are instead recovered from the remaining suppliers based on their market share. This will continue until the supplier pays to the settlement body all charges due plus accrued interest and meets the credit cover requirements; or the end of the capacity year. Should the supplier make good on its previous unpaid charges those suppliers whose charges were temporarily increased through mutualisation will receive that money via reconciliation.

Box 4.31: Most relevant sections of the draft instruments that relate to this section

Payment regulations:

- Chapter 5: Capacity Market calculations
- Chapter 8: Credit notes

Box 4.32: Consultation questions:

Payment model: invoicing, banking and payment 2

Question CM64	<ul style="list-style-type: none"> • Do you have any comments on the size of credit cover being requested?
Question CM65	<ul style="list-style-type: none"> • Do you agree with the form of credit cover being cash or a letter of collateral, if not what alternatives would you recommend?
Question CM66	<ul style="list-style-type: none"> • Noting that suppliers' credit cover amounts are based upon suppliers' own demand forecasts do you feel additional checks or controls on such forecasts are required?
Question CM67	<ul style="list-style-type: none"> • Do you feel the current credit cover default provisions are appropriate?
Question CM68	<ul style="list-style-type: none"> • Do you have any comments on Chapters 5 and 8 of the payment regulations with regards collateral requirements?

Section 4.4.5: Settlement dispute resolution process

653. It is proposed to include provision in the regulations for the resolution of Capacity Market settlement disputes relating to the calculations of the Capacity Market Settlement Agent (CMS disputes). No specific provisions are proposed for disputes about the decisions or activities of the settlement body, and it is expected that any claims against the settlement body would be made through the courts.
654. CMS disputes will be overseen by the settlement body. The settlement body will investigate the circumstances leading to the dispute, commissioning input from the settlement agent as appropriate, with the settlement body reaching a view on how the dispute should be settled. Except for recourse to the judicial system the view of the settlement body will be final and will form the basis of the charges and payments made under the Capacity Market settlement process.
655. We propose to incorporate in the regulations a general principle that CMS disputes will not suspend the normal workings of the Capacity Market settlement process. For example, if a party raises a dispute about an amount owed, it would still be obliged to make that payment within the timescales set out in regulations. Clearly if the dispute is upheld prior to this payment date it would need to pay or be paid the revised amount. If the dispute were upheld following the original payment deadline then the party would be subject to a future reconciliation through which its payments would be adjusted in line with the issued determination.
656. Only disputes relating to the calculations and determinations of the settlement agent may be raised through the CMS disputes process. It shall not for instance include disputes over the accuracy of external data provided to the settlement agent by a third party under the provisions of the Capacity Market Rules or the Balancing and Settlement Code. Such disputes must be progressed through the disputes mechanisms in those codes.

Box 4.33: Most relevant sections of the draft instruments that relate to this section

Payment regulations:

- Chapter 10: Dispute resolution

Box 4.34: Consultation questions:

Payment model: settlement disputes

Question CM69

- Do you have any comments on the process for the review of Capacity Market settlement disputes? Should there be specific provision for enforcement of obligations on the settlement body?

Question CM70	<ul style="list-style-type: none"> Do you have any comments on Chapter 10 of the payment regulations on settlement dispute resolution?
----------------------	---

Section 4.4.6: Reconciliation

657. The regulations relating to the settlement of the Capacity Market shall make provision to revise payments due to the settlement body and credits payable.
658. There will be at least 3 reconciliations for each month of a capacity year but the settlement body may require *ad-hoc* reconciliations. The last reconciliation that can take place is no later than 293 days after the month to which the payments and credits relate. Reconciliations shall update the settlement calculations resulting from one or more of the following:
- An update of data (e.g. metered demand or generation), including outturn data to replace forecast data. Such an update may occur as more accurate meter data becomes available, through the correction of an error in the data, or through the reinstatement of data missing from an earlier settlement run.
 - As an outcome of a CMS dispute.
 - A supplier no longer being in credit default
 - Where credits were reduced because payments were not received by the due date and those payments were later paid, together with late payment interest.
659. Reconciliations shall be carried out on a similar timetable to the reconciliations undertaken under the Balancing and Settlement Code. As noted previously, the vast majority of data required for Capacity Market settlement will be provided via the Balancing and Settlement Code. Therefore, the Government believes it is sensible to align reconciliations between the two.

Box 4.35: Most relevant sections of the draft instruments that relate to this section

Payment regulations:

- Chapter 11: Reconciliation

Box 4.36: Consultation questions:

Payment model: reconciliation

Question CM71	<ul style="list-style-type: none"> Do you have any comments on the timing or the approach to reconciliation? Should this be more or less frequent?
Question CM72	<ul style="list-style-type: none"> Do you have any comments on Chapter 11 of the payment regulations on reconciliation?

4.4.6.1 Role and governance of the settlement body

660. The settlement body will be a company owned by the Government limited by shares. It will mirror where practical the set-up of the counterparty, which is described in Chapter 3 of this consultation document. The Government's intention is to use, where possible, synergies between the Capacity Market settlement body and counterparty to minimise operational costs and simplify processes for CfD and Capacity Market participants. For example, the two companies may be located in the same building and may use the same settlement systems. The counterparty and Capacity Market settlement body will, however, be separate legal entities.
661. The settlement body's key roles will be to make capacity payments and to retain overall control of the Capacity Market settlement process and accountability to Parliament. The role, therefore, must be carried out by a public body. It will include:
- Specifying and monitoring a contract through which the settlement agent performs activities for the settlement body, as well as setting out performance requirements and the consequences of failing to meet them.
 - Determining Capacity Market settlement disputes relating to the calculations and determinations of the settlement agent. The settlement body may constitute an external advisory group to provide advice on disputes and/or make recommendations as to how disputes are resolved. It will remain a matter for the settlement body alone, however, to reach a determination on disputes.
 - Responsibility to Parliament and the Secretary of State in all matters concerning settlement of the Capacity Market.
 - Preparation of annual forecast budgets (one year ahead) and business plans (looking three years ahead), in liaison with the settlement agent. Separately the settlement body will need to provide to DECC within year monitoring of the costs incurred by the settlement body and its agent and compare this against its budget.
 - Preparation, at the end of each delivery year, of an annual report and accounts, which will be presented to the Secretary of State. This will be published not less than 4 months following the end of the delivery year the annual report and accounts refer to. The report will set out a review of its Capacity Market settlement activities (and those of its agent), incorporating final audited accounts for the delivery year in question. The report will include:
 - A breakdown of its expenditure against budget, detailing areas of significant under- or over-spend.
 - The performance of the settlement body and the settlement agent against their obligations as set out in regulations.
 - A report on the general performance of the settlement arrangements as set out in the regulations.
 - Continually reviewing the practical implementation of regulations that establish the settlement functions of the Capacity Market and identifying and reporting to the Secretary of State any recommended changes to the regulations. The Secretary of State will then decide whether to lay new regulations before Parliament.

662. The settlement body will be responsible for setting its own internal governance so it is able to meet its obligations. This may involve the constitution of committees and advisory bodies and use of external expert advice.
663. It is intended that the settlement body will be set up ready to process payments following the first auction. Alternative arrangements may be required in the short term to deal with requirements for the posting of bid bonds or credit cover in advance of the first auction.

4.4.6.2 Governance and constitution of the Capacity Market settlement body

664. The Capacity Market Settlement Body will be a private company limited by shares, established by the Secretary of State. The settlement body and its directors will operate within two frameworks: company law and secondary legislation implementing the Capacity Market. The governance arrangements of the Capacity Market settlement body will mirror as closely as possible the arrangements of the counterparty.

Secretary of State controls in primary and secondary legislation

665. Any aspects of the settlement body's activities that relate directly to taxation, and Secretary of State's control over those activities, will be set out in regulations. Other controls on the settlement body will be exercised through company law and the constitutional documents of the company.

Controls available through company law

666. As with the counterparty, under UK company law, the Secretary of State as sole shareholder will have ultimate control over the settlement body. This is primarily through the ability to appoint and remove directors, amend the company's constitutional documents, and give shareholder instructions to the directors. The composition of the board will be guided by best corporate governance practice; half of the board will be independent non-executive directors.
667. The Secretary of State will appoint a minority of the board including at least the chair and a senior independent director. The majority of appointments will be made via a sub-committee of the board. As sole shareholder, the Secretary of State will have the right to veto any proposed appointments to the board when they are recommended by the nominations committee, but will not be involved in the recruitment process itself. The intention is for the settlement body to be drawn from the same board membership as the counterparty, but with each member of the board owing a separate duty to each company.
668. As with other Government-owned companies the Capacity Market Settlement Body will, in addition to being subject to UK company law, also be subject to certain guidance relating to Government-owned entities, including the fact that it will be governed by a framework

document in line with HMT's guidance for managing public money in relation to arms' lengths bodies.¹²⁷

669. It is intended that the company's constitutional documents and in particular the framework document will set out the general performance reporting arrangements, stating that the shareholder (Secretary of State) will monitor the settlement body's performance through regular meetings and prompt disclosure of specified information by the settlement body, as well as setting matters not provided for in regulations or the memorandum and articles of association. The framework document will be made public.
670. As sole shareholder, the Secretary of State will be able to amend the framework document without any formal change control process (as opposed to changing the regulations which require parliamentary scrutiny). The constitutional document provisions will enable Secretary of State to:
- set strategic objectives and/or financial and performance targets for the body;
 - determine the policy and financial framework within which the company will operate;
 - grant approval rights regarding potential board members;
 - appoint a senior Government official to be the Secretary of State's representative on the board;
 - be consulted upon proposed changes to the board as well as requiring the board to escalate issues regarding the management of its agent(s); and
 - approve the directors' remuneration packages.
671. It is proposed that a clause is added to the framework document to ensure it is legally binding and that the body's sphere of activity relates to only:
- undertaking activities which are pertinent to the administration of the Capacity Market;
 - having control of those activities that it asks the settlement agent to undertake on its behalf;
 - make clear the settlement body's overarching purpose;
 - provide some comfort to market participants; and
 - set out the guiding principles and objectives for the settlement body's management of the relationship with its agent, as much of the day-to day administration of Capacity Market settlement will be carried out by the agent under a contractual arrangement.

4.4.6.3 Role of the Capacity Market Settlement Agent

¹²⁷ <https://www.gov.uk/government/publications/managing-public-money>

672. The Government has decided to designate Elexon as the settlement agent, on whom functions are conferred in the regulations in respect of calculations and determinations. This is due to its current role and expertise providing settlement services under the Balancing and Settlement Code. The role as settlement agent will be similar but more limited than the role it currently has under the Balancing and Settlement Code. In addition, Elexon will carry out a number of tasks on behalf of the settlement body, which will monitor and review settlement arrangements.
673. A contract between the settlement body and Elexon will outline the detail of the service to be delivered, the cost of that service and performance monitoring arrangements. These arrangements will allow, if required, the settlement body to initiate and co-ordinate a change of settlement agent in consultation with the Secretary of State.
674. Elexon is likely to deliver Capacity Market settlement by outsourcing the mechanical delivery aspects to an IT service provider or providers. Elexon would need to procure and manage any service providers. No IT service provider will have the discretion to take decisions.

Contract and performance management of the settlement agent

675. It is the Government's intention that the settlement body will be able to undertake an investigation of the settlement agent's performance. If upon the conclusion of such investigation, the settlement body believes the performance of the settlement agent is falling short of expected standards it will write to the chairman of the settlement agent, outlining the areas of performance shortfall and the steps the settlement agent is required to take to improve performance. The settlement agent will have a period notified by the settlement body to remedy its performance shortfall.
676. If upon the conclusion of this period the performance shortfall has not been remedied then the settlement body shall either agree an extension to the period with the settlement agent. It may also write formally to the Secretary of State recommending that he/ she moves to appoint another person as the settlement agent in line with the powers being sought in the Energy Bill.

Box 4.37: Consultation questions:

Payment model: governance

Question CM73	<ul style="list-style-type: none"> Do you have any comments on the proposed governance arrangements for the Capacity Market Settlement Body and settlement agent?
Question CM74	<ul style="list-style-type: none"> Do you have any comments on the methods through which the costs of the settlement body and its agent will be controlled and levied?

Question CM75

- Do you have any further comments on any aspects of Capacity Market settlement not covered in your responses to previous questions?

Section 4.5: Institutional and governance arrangements

677. This section explains the institutional and governance arrangements for the Capacity Market, and the main roles and responsibilities proposed.

Section 4.5.1: Institutional roles

678. Once the primary and secondary legislation has been enacted, the Capacity Market will be overseen and delivered by a combination of the Government, the regulator Ofgem, National Grid, the settlement body and the settlement agent Elexon. The scheme has been purposely designed to enable it to adapt and to allow changes which are likely to be required as experience is gained, but at the same time to honour the commitments given in individual capacity agreements. The proposals that follow seek to achieve these aims and to ensure there are proper checks in place to control how the system evolves over time.

4.5.1.1 The Government

679. The Government will remain responsible for the strategic oversight of the Capacity Market and for changes to the regulations and payment regulations, in order that it retains accountability for key aspects of the market. The regulations and payment regulations include general eligibility criteria for entry to Capacity Market auctions, auction parameters such as the demand curve and target volume, functions of National Grid for delivery of the Capacity Market, and settlement of payments.

4.5.1.2 Ofgem

680. The Government will make Capacity Market Rules, but once made, the Government proposes that Ofgem will be responsible for amending the Rules, as set out in Part 10 of the draft Electricity Capacity Regulations. The rules include technical rules and procedures such as pre-qualification and capacity auctions, and provision about the contents of capacity agreements and the obligations of capacity agreement holders.
681. This arrangement for the regulations, payment regulations and rules puts in place appropriate controls for the Government and Ofgem in order to keep budgetary control and to enable changes to the market to be made in a timely and coherent manner.
682. Ofgem may amend, add to, revoke provisions in the Capacity Market Rules and this could mean that Ofgem can expand or reduce the scope of the rules in future. So that the Rules can improve and adapt in response to learning from industry, there will be a duty on Ofgem to consider any proposal for a rule change that it receives. Industry, delivery partners and the public will be able to suggest changes. The Government does not propose that industry can block or appeal a change to the rules, but there will be a requirement for Ofgem to consult on

all changes it decides to make. Ofgem will have discretion on how long the consultation should be in light of the extent of the change.

683. Ofgem itself may choose to publish guidance for industry on the process it intends to use to amend the rules. This guidance, for example, could standardise processes for minor, normal and major rule changes.
684. It is proposed that Ofgem will be responsible for resolution of disputes by applicants about the outcome of pre-qualification (see Section 4.2.2). In addition, the Government proposes that the regulations should provide dispute resolution processes for Capacity Market participants in the event that they are unsatisfied with the way in which the rules have been applied by National Grid in certain circumstances. Those circumstances are a refusal by National Grid to rectify the Capacity Market register; a case where a capacity provider has been unable to agree with National Grid any necessary amendments to the capacity agreement; and where a capacity provider is dissatisfied with a decision by National Grid to carry out a spot test. The Government proposes that Ofgem should carry out these reviews as well, but both whether these events are appealable and if so who the appeals body might be is still being considered and discussed with Ofgem.

4.5.1.3 National Grid

685. National Grid will undertake the delivery role, including providing advice to ministers on the security of supply outlook and recommended amount of capacity to auction to meet the reliability standard; pre-qualifying auction participants, administering the auction and issuing Capacity Agreements; and developing and administering new supporting procedures e.g. to provide Capacity Market warnings.
686. The Government will set the EMR delivery functions of National Grid in secondary legislation, which will become 'relevant requirements', enforceable by Ofgem as if they were licence conditions. The secondary legislation, regulations and rules, will prescribe the EMR functions that National Grid must carry out, in order that the Government has certainty about what will be delivered and that Ofgem has a clear basis on which to manage the performance of National Grid in its delivery role.
687. A panel of technical experts will provide independent scrutiny of National Grid's advice on the level of capacity to auction.

4.5.1.4 Capacity Market Settlement Body and Capacity Market Settlement Agent (Elexon)

688. The Capacity Market Settlement Body will be private company limited by shares, established and wholly owned by the Secretary of State; set up to provide ultimate accountability, governance and control of the monies collected and disbursed under the payment

regulations. The settlement body and its directors will operate within two frameworks: company law and secondary legislation implementing the Capacity Market. The governance arrangements of the Capacity Market Settlement Body will mirror as closely as possible the arrangements of the counterparty. However the CfD counterparty and Capacity Market Settlement Body will be separate legal entities.

689. The Secretary of State will be the sole shareholder of the settlement body and will have control over the settlement body, primarily through the ability to appoint and remove directors, amend the company's constitutional documents and give shareholder direction to the board. The settlement body's constitutional documents will set out the general performance and reporting arrangements (including the management and performance of the settlement agent), stating that the Secretary of State as shareholder will monitor the settlement body's performance through regular meetings and prompt disclosure of specified information by the settlement body. A contract between the settlement body and the settlement agent (Elexon) will outline the detail of the service to be delivered, the cost of that service and performance monitoring arrangements. The Government's intention is to use, where possible, synergies between the two bodies to minimise operational costs and simplify processes for CfD and Capacity Market participants.

4.5.1.5 Conflicts of interest

690. The potential for conflicts of interest between National Grid's role in EMR and its existing interests in the energy market was recently subject to a joint assessment by the Government and Ofgem.¹²⁸
691. The joint analysis conducted by DECC and Ofgem has concluded that, on the basis of existing National Grid activities, current market arrangements, and the current design of EMR, conflicts of interest are manageable subject to the implementation of various mitigation measures. The proposed mitigations include the continued design of EMR in a way that minimises the risks of conflicts of interest arising, through transparency, scrutiny and limits on the National Grid's discretion and the proportionate ring-fencing of some of the EMR functions. The ring-fencing will include staff that will carry out the capacity auction. The measures are intended to protect confidential information that National Grid may have access to and minimise the risk of conflicts of interest arising. The Government will keep these measures under review to ensure they remain effective. Further details are available in Chapter 5.

4.5.1.6 Confidentiality

¹²⁸ Available at: <https://www.gov.uk/government/consultations/synergies-and-conflicts-of-interest-arising-from-the-system-operator-delivering-electricity-market-reform-emr>

692. Provisions on confidentiality will be finalised to be consistent with protection of information measures in the regulations and proposed modifications to National Grid’s transmission licence to address potential conflicts of interest as set out in Chapter 6 of this consultation. These amendments include a number of provisions to protect information submitted to the delivery body for the purposes of it carrying out its functions under the regulations and the rulebook.

Box 4.38: Most relevant sections of the draft instruments that relate to this section

Regulations:

- Part 2: Reliability standard
- Part 3: Electricity capacity report
- Part 4: Capacity auctions
 - v. Chapter 1: Determining whether capacity auction to be held
 - vi. Chapter 2: Auction parameters
 - vii. Chapter 3: Eligibility criteria
- Part 7: Information
- Part 9: Appeals
- Part 10: Capacity Market Rules
- Part 11: Other functions of the Secretary of State and the Authority

Box 4.39: Consultation questions: Institutions and governance

Question CM76

- Do you have any comments on the proposed institutional and governance arrangements for the Capacity Market? In particular that Ofgem will be responsible for amending the Capacity Market Rules, and the process for changing the rules and regulations.

Question CM77

- Do you think it would be preferable for the Electricity Capacity Regulations to set objectives for the Capacity Market Rules? Such objectives may allow Ofgem to more easily assess the merits of a proposed change to the rules. If so what do you think these objectives should be?

Section 4.5.2: Devolved Administrations

693. The Capacity Market will cover England, Wales and Scotland, but will not apply in Northern Ireland. Northern Ireland is part of the Single Electricity Market that extends across both Ireland and Northern Ireland, which has operated a separate capacity mechanism since 2007.

694. To ensure the most suitable design and implementation for GB as a whole, and to ensure any relevant devolved powers and responsibilities are respected, we will continue engagement with the Devolved Administrations as the implementing legislation is further developed and the mechanism deployed.

Section 4.6: Legal Framework for the Capacity Market

695. This section describes the legal framework that enables the introduction of the Capacity Market. It also covers the proposed nature of a capacity agreement in more detail and summarises the rights and obligations which would apply to a Capacity Market participant under the proposed agreement. The proposed delivery obligations, payments and penalties are described in Sections 4.2 and 4.4 of this chapter.

Section 4.6.1: Legal Framework

4.6.1.1 Electricity Capacity Regulations and Capacity Market Rules

696. The Energy Bill includes powers for the Secretary of State to introduce the Capacity Market. The draft legislation, set out in a combination of Electricity Capacity Regulations, Electricity Capacity (Payment) Regulations, and Capacity Market Rules, has been published for consultation alongside this document.
697. The regulations and payment regulations, which will be made and overseen by the Secretary of State, include aspects covering the amount of capacity to auction, eligibility criteria and settlement of payments. The rules, which will be made by the Secretary of State and then overseen and owned by Ofgem, include technical rules and procedures as to how the Capacity Market will operate, covering pre-qualification, the capacity auction process and penalties.
698. If a bidder is successful in the capacity auction, in respect of a CMU the bidder will accrue rights and obligations in accordance with the regulations and Capacity Market Rules.¹²⁹ These will include the obligation to provide capacity, the right to receive capacity payments and the liability to pay penalties. Reference to a capacity agreement means the rights and obligations which accrue under the regulations and rules.
699. A proposed template of a capacity agreement notice is included in the draft Capacity Market Rules for this consultation. This demonstrates the details which would be contained in the capacity agreement notice which, as well stating the capacity obligation and entitlement to a

¹²⁹ Pre-qualification applications, and bids in the subsequent auction rounds, will be at a Capacity Market Unit (CMU) level rather than a plant level, although the two concepts may be synonymous depending on how a plant is structured. Depending on the context this can be either a generating CMU that delivers energy by generating, or a DSR CMU that delivers energy by reducing demand. Storage participants may be made up of a combination of generation CMUs (where electricity is provided by releasing it from storage) or DSR CMUs (where electricity is provided by ceasing imports from the grid to replenish storage). A generating CMU must be capable of exporting electricity independently from other units and have a dedicated half-hourly meter.

capacity payment, will also include the relevant delivery year(s), the clearing price to be used and key details of the CMU, capacity provider and, where applicable, the portfolio holder.

4.6.1.2 Consequential amendments to existing licences and industry documents

700. As a consequence of the Energy Bill's provisions to implement the Capacity Market, existing electricity licences, industry documents and related agreements are likely to require consequential amendments. The Energy Bill includes provisions for the Secretary of State to modify licence conditions and documents maintained under licence conditions, together with related agreements, for the purpose of giving effect to the Capacity Market. These modifications, if required, will be in addition to the Electricity Capacity Regulations and the Capacity Market Rules.
701. Working with Ofgem, National Grid and Elexon, the Government will be assessing which existing licence conditions, industry documents and agreements may need consequential amendments and will publish the proposed amendments in early 2014 and seek views from interested parties.
702. As these modifications are identified and progressed, full consideration will be given to existing code modifications that are progressing through the prescribed code modification processes, in order to ensure consistency of approach and no unintended overlaps or inconsistencies resulting from the amendments.
703. From the initial work already undertaken, it appears possible that the existing licences and associated industry documents listed in Box 4.40 may require consequential amendment or will need to be analysed in order to identify whether a consequential amendment is necessary:

Box 4.40: Existing electricity licences that might require an amendment	Existing electricity industry documents that might require an amendment or consideration of whether an amendment is necessary
<ul style="list-style-type: none"> • Generation licence • Transmission licence • Supply licence • Distribution licence 	<ul style="list-style-type: none"> • Grid Code • CUSC • Balancing and Settlement Code • STC • GB Security and Quality of Supply Standard

Section 4.6.2: Nature of a capacity agreement

704. A capacity agreement, i.e. the rights and obligations in accordance with the Electricity Capacity Regulations and Capacity Market Rules as noted above, will be evidenced by the entry on a Capacity Market register and by the issue of a capacity agreement notice to the owner of each successful CMU. Neither the register nor the capacity agreement notice is intended to create a contractual relationship between the capacity provider and any other party.
705. The obligation to deliver energy would be a statutory obligation which applies to the registered holder of a capacity agreement notice. Breach of the obligation has the consequences set out in the Rules and would result in reduced or suspended payments or the set off of penalties against payments otherwise due.
706. Capacity payments to capacity providers would be made by the settlement agent from funds received via the charges levied on suppliers. The obligation on suppliers to pay the levy would be enforceable by Ofgem. Section 4.4 sets out the process for resolving Capacity Market settlement disputes relating to the calculations of the Capacity Market Settlement Agent.
707. National Grid will be responsible for collecting and assessing all operational data associated with system events and for monitoring the performance by capacity providers of their capacity obligations. National Grid will be responsible to Ofgem for the performance of its duties as delivery body.

4.6.2.1 Capacity agreement notice

708. A capacity agreement notice will be issued by National Grid in respect of each successful CMU within 20 business days of the auction result, stating that the holder has the rights and obligations pursuant to the regulations and rules. It will also include details of:
- The obligation on the holder to deliver electrical energy or reduce demand.
 - The entitlement to a capacity payment.
 - The auction in question and whether it is a four year ahead or one year ahead auction, the relevant delivery year(s) and the price which will be used in determining capacity payments.
 - The capacity provider and, where applicable, the portfolio holder.
 - The CMU in question, its type (as a generating unit within the balancing mechanism or as a CDR unit / embedded generator outside the balancing mechanism) and its classification (e.g. as an existing, prospective or refurbishing generating unit), as well as the de-rated capacity figure, the meter details and whether it is a price-maker or price-taker.
709. We propose that the capacity provider should be able to request an amendment to a capacity agreement notice within 10 business days of its issue, but only in respect of a factual inaccuracy. Where any amendments are agreed, a new capacity agreement notice will be

issued and the register updated. If this cannot be agreed within 20 business days from receipt of the request, the provider would have a further 10 business days in which to request that the decision be reviewed under the appeals process set out in the rules.

4.6.2.2 Capacity Market register

710. A Capacity Market register, maintained by National Grid, will record each successful CMU. The entry on the register confirms the existence of a capacity agreement and the right to a capacity payment for that CMU for the stated delivery year(s). A form of the register is intended to be publically available.
711. The entry in the Capacity Market register is the definitive document and, in the event of conflict, the Capacity Market register would take precedence over the capacity agreement notice.

4.6.2.3 Payment

712. Payments to capacity providers will be funded by the charges levied on suppliers. The settlement body will be responsible (via Elexon as settlement agent) for collecting payments due from suppliers for payment to the capacity providers. Details of the settlement process and governance are contained in Section 4.4.
713. A capacity provider will be entitled to receive capacity payments for the relevant delivery year(s) which will be calculated and, following collection of funds via the levy on suppliers, paid by Elexon in accordance with the price and capacity details in the Capacity Market register. Elexon is similarly responsible for the calculation and collection of any penalties payable by a capacity provider, which may be set off against payments otherwise due to the provider. Payments will be made on a monthly basis in arrears in accordance with the payment model described in Section 4.4. Section 4.4 also sets out the process for resolving Capacity Market settlement disputes relating to the calculations of the settlement agent.

4.6.2.4 Disputes and appeals

714. A dispute would be raised with National Grid in the first instance. The proposed rules include a process for a person dissatisfied with a notice from National Grid (including a prequalification decision, the issue or amendment of a capacity agreement notice, amendment of the capacity register, a termination notice or a spot testing decision) to request that the decision be reconsidered. We are also considering whether there would be a second stage appeal under the regulations and who that appeal might be to and whether there would be a further right of appeal to the courts.
715. Settlement disputes relating to the calculations of the settlement agent would be referred to the Capacity Market Settlement Body.

4.6.2.5 Force majeure

716. It is not proposed to have any general force majeure provision relating to failure to deliver the capacity obligation. The only exceptional circumstances in which the Government proposes that a capacity provider will be relieved of its delivery obligation are if National Grid constraints have prevented delivery (or if a new build project is delayed due to Transmission Owner or Distribution Network Operator delays in providing a transmission connection), or if the electricity market has been suspended.

4.6.2.6 Change

717. Although a capacity provider would, after obtaining a capacity agreement, have to comply with any subsequent changes to the regulations or rules, the details entered in the Capacity Market register would not change. Hence the duration of the capacity agreement, the clearing price applicable for that duration and the de-rated capacity of the CMU (unless the de-rated capacity figure is otherwise changed under the rules) would not change by virtue of a change in the legislation.

4.6.2.7 Transfer

718. The Government proposes that it should be possible for a capacity agreement to be physically traded by transferring it for a specified period or to be transferred outright with its relevant CMU.
719. The Government is further considering the tax treatment of secondary trading/novation of capacity agreements. In particular, whether these transactions are subject to VAT or stamp duty. Should the transaction be subject to either tax, further detail will be provided regarding the way in which this will be implemented.
720. For physical trading, all or part of the capacity agreement could be transferred to an acceptable transferee for a specified number of settlement periods provided a transfer is for at least a 24 hour period. However, a capacity agreement could not be physically traded in this way if the transferor has accrued liabilities for penalties which remain unpaid at time of proposed transfer.
721. A capacity agreement could be transferred outright, but only together with the relevant CMU. Similarly, the CMU itself cannot be transferred or sold to another party unless the transferee is an acceptable transferee – in this case that it meets the pre-qualification criteria and meets the credit support requirements. As the CMU is also being transferred in this case, any liability for accrued penalties would transfer with the CMU.

4.6.2.8 Termination and other remedies

722. Should the entire Capacity Market be withdrawn at some future point, it is the intention that all existing capacity agreements will continue to their expiry date, including any longer term agreements with prospective new build units.
723. Should a unit participate in a renewable support scheme or be supported under a CfD, it must request cancellation of its capacity agreement and withdraw from the Capacity Market prior to the one year ahead auction for the relevant delivery year. If it fails to do so in time, it must trade its capacity agreement for the full delivery year.

Termination

724. It is proposed that a capacity agreement may otherwise only be terminated in specific circumstances where the capacity provider has:
- Failed to demonstrate a financial commitment. As set out in Section 4.2, this would apply to a prospective new build CMU where it has failed to demonstrate that it has incurred at least 50% of the project expenditure (as identified at the prequalification stage) at a 12 month milestone date from the award of the capacity agreement.
 - A termination fee would be payable (based on $0.5 * \text{net cost of new entry} * \text{capacity obligation}$) which would be drawn from the collateral posted as part of the pre-qualification.
 - A CMU which has had its capacity agreement terminated in this way, may bid again in succeeding auctions for a new capacity agreement (but must still pay the termination fee as outlined above).
 - Failed to achieve substantial completion. This would apply where a prospective new build CMU had not achieved a minimum completion level of 50% of its intended capacity by a long stop date 18 months after the start of its first delivery year.¹³⁰ A termination fee would be payable based on $0.5 * \text{net cost of new entry} * \text{capacity obligation} + \text{a measure of economic damage}$ (calculated by the settlement agent according to the cost of blackouts versus the cost of new entry) resulting from the delay. Such capacity as is complete would be eligible to participate in subsequent auctions as a price taker.
 - Failed to obtain a connection agreement offer. This would apply where a distribution connected prospective CMU had failed to submit its connection offer to National Grid by the latest date of 18 months prior to the start of the relevant delivery year.
 - Failed to prove the CDR capacity. This would apply to an unproven CDR unit which had not submitted a test certificate proving its capacity by the latest date of the start of the delivery year. The bid bond would be forfeited as a result.

¹³⁰ This would be determined by the System Operator on the basis of the Interim Operational Notification (ION) or, in the case of a distribution network connected CMU, by an independent technical advisor's report submitted by the provider.

- Is insolvent and is the subject of a winding-up order which has not been cured within a 90 day period.¹³¹
- Failed or ceases to meet the general eligibility criteria set out in the regulations.
- Opted out in a previous auction as temporarily non-operational but had generated. This applies where a CMU has generated contrary to a previous opt out notification in which it was declared as temporarily non-operational, and is restricted from participation, but has already been awarded a capacity agreement for a delivery year subsequent to the year in which it opted out.

725. It is proposed that where the above circumstances apply, or where the Secretary of State notifies National Grid of an actual or suspected breach of the ethical requirements, National Grid must issue a notice to the capacity provider that the capacity agreement will terminate in 60 business days.

726. During this 60 business day period, the capacity provider may request that the issue of a termination notice be reconsidered and it is also proposed that the Secretary of State would have the right, during that period, to instruct that the notice of termination be withdrawn.

Other remedies

727. Different remedies, such as set off, deferral or suspension of payments or an adjustment to the term or to the de-rated capacity figure, would apply in other specific circumstances. These are summarised below where the capacity provider has:

- Failed (in the case of a refurbishing CMU) to meet the financial commitment milestone. In such case, the capacity agreement would be reduced to one year and the de-rating figure adjusted as applicable (as no refurbishment is assumed to be taking place for that delivery year). The CMU would be restricted for a two year period from bidding again for a contract longer than one year.
- Failed (in the case of a refurbishing CMU) to achieve substantial completion. If the CMU has not achieved full completion by 24 months after the auction results date i.e. two years ahead of the delivery year (no further long stop date applies), this would result in the capacity agreement being reduced to one year and the de-rated capacity adjusted as appropriate. The pre-refurbishment CMU may bid in future auctions (but would be restricted for a two year period from bidding again as a refurbishing CMU)
- Failed (in the case of a prospective new build CMU) to complete the full intended capacity. A CMU which achieves more than the minimum 50% completion, but less

¹³¹ An Insolvency Termination Event is proposed. This would trigger proceedings against the capacity provider seeking a judgment of insolvency or bankruptcy (or any other relief under any bankruptcy / insolvency or similar law), or a petition for the capacity provider's winding-up or liquidation, which results in a judgment of insolvency or bankruptcy or the entry of an order for relief or an order for its winding-up or liquidation; and which is not dismissed, discharged, stayed or restrained within 90 days.

than 90%, by the 18 month long stop date would have a further six month period in which to reach 100% completion. Failure to reach the 100% level by the further six month date would result in the capacity agreement being adjusted to reflect the operational capacity as at that two year date. Capacity payments (and liability for penalties) would commence at this point, but the overall term of the capacity agreement is not extended by any period of delay i.e. the term would always run from the start of the first delivery year.

- Becomes insolvent (but where it is not a termination event as described above). Payments under the capacity agreement would be deferred and accrued capacity payments would be made at the end of the delivery year (or earlier if the insolvency is cured or to a new owner if the capacity agreement is transferred outright with the CMU). If the insolvency persists over more than one delivery year, the accrued capacity payments would be paid for the year ending and capacity payments for the new delivery year would again be deferred.
 - During any such deferral of capacity payments, the CMU must still be able to meet its capacity obligation. The liability for penalties would continue to apply and penalty payments due would be set off against any accrued capacity payments.
- Failed to pay penalties. Penalty payments would be set off against capacity payments. The liability for penalties and the right to set off against capacity payments would roll across future delivery years for that capacity agreement, or across a subsequent capacity agreement. If a provider opts out of the Capacity Market in future years, payment for outstanding penalties may be pursued through the courts.
- Failed a spot test (if required to undertake a spot test after having failed to generate at its de-rated capacity on the minimum of three occasions in the previous October to March period). Capacity payments would be suspended until the CMU has satisfactorily passed a further test. The capacity obligation and the liability for penalties would nevertheless apply during this time.
- Failed to notify (in the case of a CDR unit) changes to its baseline or connection details. Capacity payments would be suspended until proper notification is given.

Box 4.41: Consultation questions:	Nature of a capacity agreement
Question CM78	<ul style="list-style-type: none"> • Do you have any comments on the draft capacity agreement notice template?
Question CM79	<ul style="list-style-type: none"> • Do you have any comments on the nature of a capacity agreement? • The proposed capacity agreement will create statutory rights and obligations which can be enforced by Ofgem – so capacity agreements should serve the same ends as private law contracts. Capacity agreements will be funded by a full credit strength settlement body as described in Section 4.4. This regime has desirable parallels and consistency

	with the existing Balancing Mechanism. Are there any other features or attributes that ought to be incorporated to ensure the regime is investable (including for lenders)?
Question CM80	<ul style="list-style-type: none"> Do you consider the test of financial commitment which applies to new build or refurbishing CMUs to be appropriate?
Question CM81	<ul style="list-style-type: none"> Do you consider the proposed provisions relating to termination of a capacity agreement to be appropriate and a proportionate balance between ensuring that capacity is delivered and affording appropriate safeguards to investors? Do you consider the timescales and appeal process relating to termination to be appropriate?
Question CM82	<ul style="list-style-type: none"> Do you consider the sanctions other than termination for failure or delay of new or refurbishing capacity to achieve substantial completion to be appropriate?
Question CM83	<ul style="list-style-type: none"> Do you consider the enforceability of payments due to, or from, a capacity provider to be sufficiently robust under the proposed structure?

Section 4.7: Ensuring the Capacity Market meets its objectives

728. The Capacity Market has been designed to enable the provision of adequate reliable capacity in the GB electricity market at minimum cost to consumers in a way that minimises unintended consequences and risks, and supports delivery of wider Government objectives (particularly enabling the decarbonisation of the electricity system, the development of a more responsive demand side in the electricity market, and further integration of the European internal energy market).

Section 4.7.1: Ensuring sufficient investment

729. The Capacity Market should ensure sufficient investment by bringing forward the amount of capacity needed to meet the reliability standard each delivery year. There are a number of design features which should ensure investors have the confidence they need to commit to the necessary investment:
- The Capacity Market allows the market to discover the price of capacity sufficient to bring forward the level of capacity needed, and participants awarded a capacity agreement will know that in the delivery year/s they will receive a guaranteed income stream for their capacity, regardless of how often they are able to run competitively in the electricity market.
 - Holding the main auctions four years ahead of the delivery year means participants have time to compete then build a new power station before the delivery year.
 - Longer-term capacity agreements for capacity providers building new plants should help investors secure finance for new plants.
 - The pay as clear auction format means investors can count on a fair reward for capacity they provide in future, once initial capacity agreements expire.
 - A cap on penalties of 101-150% and the concept of a four hour warning should help ensure the risk of participation remains manageable for investors.

Section 4.7.2: Ensuring value for money for consumers

730. The Government will publish an updated Capacity Market Impact Assessment later this month, setting out its estimate of the costs of the Capacity Market on consumer bills as well as the wider economic impacts of the Capacity Market. However, the Government expects that a Capacity Market should have limited impact on bills for household and industry consumers, since the costs of capacity should be partly offset by a reduction in electricity prices and as the Capacity Market should reduce the financing costs for the investment needed in new capacity.
731. There are a number of design features which should ensure the Capacity Market provides value for money for consumers:
- The Capacity Market is open to existing and new capacity to ensure the most cost effective sources are awarded capacity agreements.

- The pre-qualification process and spot testing of participants will help ensure all contracted capacity is physically capable of delivering the level of energy specified in its capacity agreement.
- Holding the main auction four years ahead of delivery and giving providers of new capacity access to longer agreements will help ensure competition in the auction and keep costs down.
- The demand curve for each auction will set a price cap for capacity based on the cost of providing new capacity.
- There are also a number of other proposed measures designed to prevent gaming in the Capacity Market, including:
 - i. Pre-qualification is proposed to be mandatory so where plants opt out of the auction, demand can be lowered.
 - ii. Participants' capacity value is proposed to be administratively determined – preventing providers from understating the capacity value of their plants to withhold capacity from the auction.
 - iii. There are proposed provisions to cancel or postpone the auction if it is undersubscribed.
 - iv. Existing plants are proposed to be required to act as price takers in the auction unless they justify the need for a higher payment.
 - v. The level of supply in each auction and the identity of particular bidders are proposed to be concealed to mitigate risk of collusion.
 - vi. The proposed demand curve will ensure the capacity price is less sensitive to the volume of capacity offered into the auction and so reduce incentives for participants to withhold capacity from the auction
 - vii. The proposed auction monitor will monitor the auction and provide validation that the auction followed the rules.
 - viii. The proposed strong penalty regime for providers that fail to deliver energy when needed will help mitigate the risk of overpayment for unreliable plant.

Section 4.7.3: Supporting the delivery of wider Government objectives

732. The Capacity Market will support the decarbonisation of the electricity system by ensuring that as we make the transition to more intermittent and inflexible generation sources there is sufficient total reliable capacity to meet demand.
733. The Government is committed to completing the European internal energy market, and the Capacity Market has been designed to support its development. For example:
- The Capacity Market will not place any restrictions on trade, and internal market rules will govern the import and export of electricity between neighbouring markets so that electricity flows from areas with lower prices to areas with higher prices.
 - The Government recognises the potential for interconnected capacity to participate directly in the Capacity Market and is pursuing further work to identify whether this is possible in a way that is compatible with internal market rules and provides adequate assurance of physical delivery. For as long as a solution cannot be found, the value of

interconnection will be taken into account as part of the annual capacity assessment process, and the level of imports expected through interconnectors will be subtracted from the amount auctioned in the Capacity Market.

- The Capacity Market has been designed to be consistent with Ofgem’s ongoing work to reform balancing arrangements and sharpen marginal electricity prices. This will provide additional incentives for investment in interconnection and is the focus of further work across Europe to increase the efficiency of the price signals that determine imports and exports between countries.

Section 4.7.4: Review and exit

734. The Capacity Market addresses fundamental failures in the electricity market, and is therefore expected to be required for at least ten years once implemented.
735. However, it may be right to exit the Capacity Market if the underlying electricity market develops sufficiently, particularly through development of greater market liquidity, an active demand side, and more interconnection.
736. Ongoing work to improve the functioning of the electricity market, such as the rollout of Smart Meters, Ofgem’s work on cash out reform, and work in Europe to complete the internal energy market, are all important complements to the Capacity Market. By supporting the development of the demand side, the Capacity Market itself will also contribute to the market developments that could render it unnecessary in the longer term.
737. Given this, the Capacity Market has been designed so that it can be exited from in future. For example:
- The establishment of a reliability standard and annual decisions on how much capacity to auction will reduce the risk of over procurement, and mean ‘stranded assets’ are not created.
 - Participants will not be eligible for multi-year agreements unless they are new plants or undertaking significant refurbishment.
738. The need for a Capacity Market will also be reviewed every five years. The reviews will lead to the publication of a report which sets out the objectives of the Capacity Market, assesses the extent to which these objectives have been achieved and the extent to which they remain appropriate or could be achieved in a way that imposes less regulation. The high level objectives of the Capacity Market are:
- **Security of supply:** incentivise sufficient investment in generation & not generation capacity to ensure security of supply.
 - **Cost Effectiveness:** implement changes at minimum cost to consumers.
 - **Avoid unintended consequences:** minimise design risks and ensure compatibility with other energy market policies.
739. An overarching purpose of the review will be for the Government to consider the current, and future role of the Capacity Market. A two-stage review process is therefore proposed, which

will result in a pair of documents first published alongside the DECC delivery plan in late 2018.

740. It is proposed that Ofgem will first carry out a review of those areas of the Capacity Market design that are covered in the rules, looking at the effectiveness of the Capacity Market and whether existing code arrangements are fit for purpose. Ofgem's review would consider what rules it has changed, what it is changing and what it intends to change. This will build on the ongoing reviews on operational effectiveness of the Capacity Market that it is proposed that Ofgem will also carry out. Ofgem will determine what this review should cover and how/when to consult in order to inform this review – but the review will be carried out in sufficient time to inform the Government's wider review.
741. The Government will then take a holistic view of the Capacity Market in the context of the above objectives in order to address the high-level question of whether the Capacity Market is still needed. This will be informed by the Government's annual internal consideration of whether to run each capacity auction (see below) as well as the finding of Ofgem's first stage review. The Government will consult as part of the review process, and will share the conclusions of the five-yearly review with the devolved administrations. This five-yearly review does not preclude the Government carrying out *ad-hoc* reviews of certain areas of the Capacity Market if necessary.
742. It is proposed that the Government and Ofgem will retain the ability to request information from any of the Capacity Market's administrative parties, electricity suppliers or the owners of a CMU for the purposes of reviewing the Capacity Market or for amending the Capacity Market's rules respectively. Such provisions are required to help any review or amendments are made on the basis of comprehensive data. The regulations include provisions for the protection of information and views are welcomed on whether these provide sufficient assurance to parties. Views are also sought on whether sanctions would be appropriate to cover the event of a party providing false or misleading information in response to a request from the Government or Ofgem.

Box 4.42: Most relevant sections of the draft instruments that relate to this section

Regulations:

- Part 7: Information
- Part 12: Transitory provision and repeal

Box 4.43: Consultation questions: Ensuring the Capacity Market meets its objectives

Question CM84	<ul style="list-style-type: none"> • Has the Government got the right balance between ensuring investors have sufficient certainty to bring forward the investment in capacity we need, and ensuring consumers' interests are protected?
Question CM85	<ul style="list-style-type: none"> • Can the proposed design of the Capacity Market be simplified without sacrificing the ability for the mechanism to deliver the Government's objectives?
Question CM86	<ul style="list-style-type: none"> • Do you agree that the Capacity Market design appropriately mitigates against the risk of gaming in the auction?
Question CM87	<ul style="list-style-type: none"> • Is there more that could be done to ensure the proposed design supports the delivery of wider Government objectives such as the development of the internal energy market?
Question CM88	<ul style="list-style-type: none"> • Do you have any comments on the proposed five-yearly review process?
Question CM89	<ul style="list-style-type: none"> • Should there be sanctions to cover the event of a party providing false or misleading information in response to a request from the Government or Ofgem for the purposes of reviewing the Capacity Market? If so what should these sanctions be?
Question CM90	<ul style="list-style-type: none"> • Do you have any comments on the proposed provisions for the protection of information in Part 7 of the Regulations?
Question CM91	<ul style="list-style-type: none"> • Do you have any comments on Parts 7 and 12 of the regulations?

Section 4.8: Capacity Market Units (CMUs) and pre-qualification requirements

743. This section includes a more detailed description of CMUs and how they will be defined, along with more detail on the proposed pre-qualification requirements for different participants.

Section 4.8.1: Capacity Market Units (CMUs)

744. There are two categories of Capacity Market resources known as generating Capacity Market Units and customer demand response (CDR) Capacity Market units (CMUs).

745. There are three types of generating CMUs:

- CMRS transmission CMU: A generating unit connected to the transmission system and which participates in the balancing mechanism. This type of CMU includes (traditional) conventional large scale generating units, storage and CHP.¹³²
- CMRS distribution ('embedded') CMU: A generating unit connected to the distribution system which participates in the balancing mechanism. This type of CMU would generally be of a smaller scale and it could also include smaller scale CHP and storage.
- Non-CMRS distribution CMU: A distribution-connected generating unit that does not participate in the balancing mechanism. This type of CMU would be of a smaller scale (possibly non-licenced) and could also include smaller scale CHP and storage.

746. CDR CMUs take the form of customer response in the form of reduction of demand or an increase in on-site generation which will be visible in the supplier metering account and measured by the 'X of Y' baseline methodology (see Section 4.3).

747. This list of CMU types will be kept under review and as experience gains may be amended for example to permit participation by Energy Demand Response resources.

748. CMUs must be at least 2MW to be eligible for the Capacity Market, but smaller resources can aggregate and present themselves as a CMU.

¹³² CMRS refers to the Central Meter Registration Service. CMRS CMUs refers to a CMU with a metering system registered in the CMRS in accordance with section K of the Balancing and Settlement Code.

749. The different categories of CMU are also explained in Figure 4.18.

Figure 4.18: Categorisation of Capacity Market Units (CMUs)

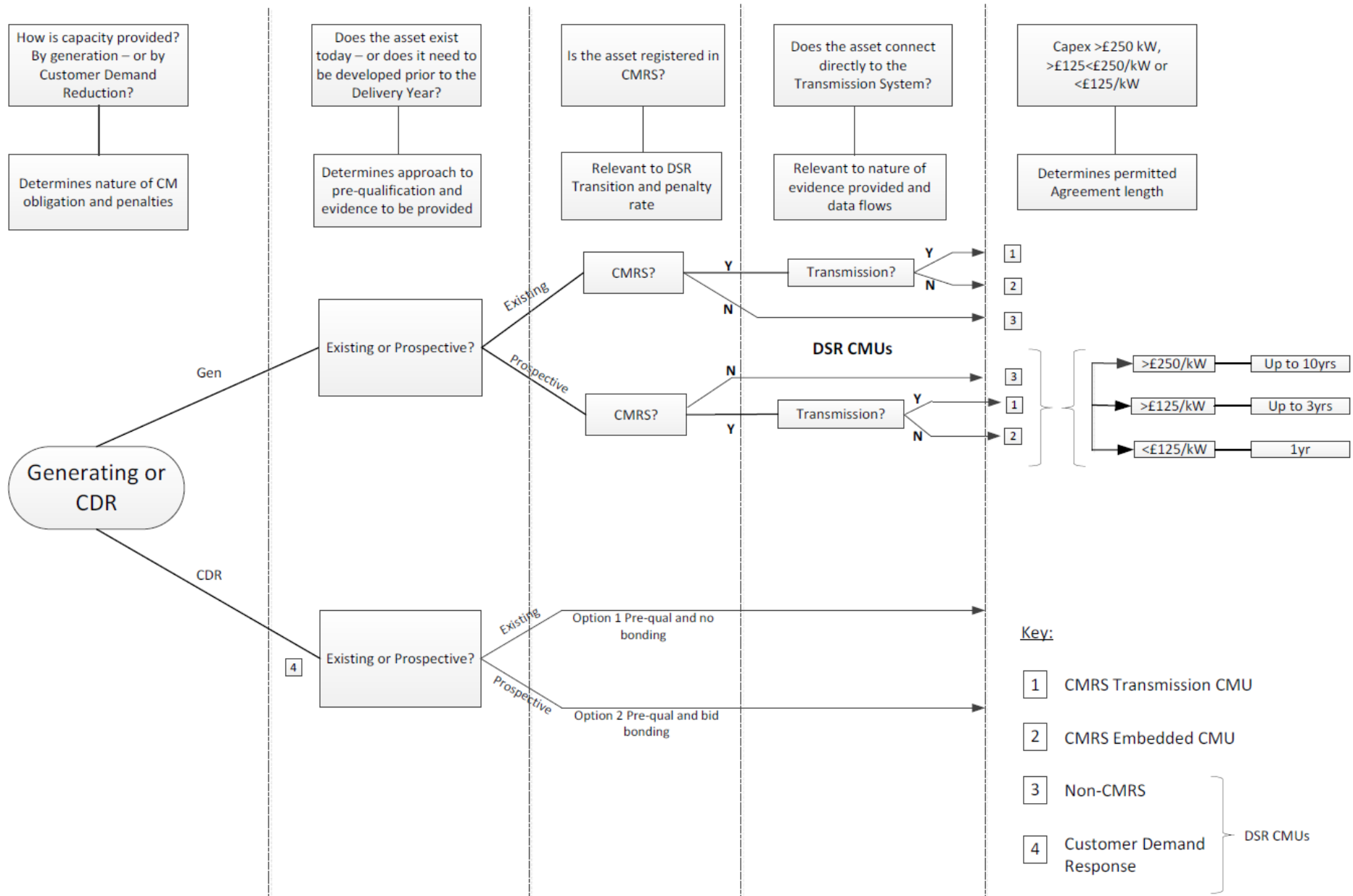

Section 4.8.2: Pre-qualification requirements

750. Section 4.2.2 covers the purpose and timing of pre-qualification. This section includes more detail on pre-qualification requirements.
751. The Government proposes different pre-qualification criteria depending on whether the applicant is an existing plant, an existing plant seeking support for refurbishment, a potential new plant, or a DSR provider. All applicants intending to participate in the auction will be required to include basic administrative details (e.g. name, company registration, bank account details, legal structure, portfolio holder, and low carbon support scheme status) along with plant-specific information. Figure 4.19 sets out the information required in pre-qualification.
752. It is proposed that existing plants must include generation licence status, details of connection/distribution agreements and transmission entry capacity (TEC) status (if relevant),¹³³ along with evidence of their historic performance over their two previous years of operation. An existing plant electing to be a price maker will also have to prepare a board-approved justification (see Section 4.2.3).
753. Existing plants seeking support for refurbishment will also have to submit any relevant planning consents, a milestone plan detailing key dates in their refurbishment timeline and a refurbishment plan detailing their proposed capital expenditure for the refurbishment.
754. New build plants will have to submit all relevant planning consents (note a planning application will not be sufficient; evidence of consent will be required) as well as submitting a construction milestone plan detailing the dates in which key stages to achieve operation will be achieved – such as commencement of construction works and achievement of energisation operational notification (EON) status.¹³⁴ New build plants will also need to supply a valid connection/distribution agreement or certify that a distribution agreement will be in place by the relevant delivery year.
755. Prospective new build plants will also be required to provide collateral representing 100% of the level of the termination fee (see Box 4.10 in Section 4.2.3) for which they would be liable if they failed to demonstrate the substantial financial commitment milestone 12 months after the auction. The accepted forms of collateral are aligned with Ofgem’s best practice guidelines for gas and electricity network operator credit cover, and include letter of credit, cash deposits, bilateral insurance and a performance bond. A wider range of forms will be accepted than for supplier collateral to reduce initial barriers to entry for new plants and

¹³³ Transmission Entry Capacity (TEC) is the amount of generation a generator wishes to export onto the National Electricity Transmission System.

¹³⁴ The concept of energisation operational notification is explained on page 3 here: http://www.nationalgrid.com/NR/rdonlyres/D196A1A7-0637-4882-911B-737FBAACD25D/55802/7_COMPLIANCE_PROCESSES_I5R1.pdf

because termination fee defaults have less immediacy than covering monthly capacity payments. The Government is considering whether the collateral requirement should be applied in respect of the 2014 capacity auction or from a later date.

756. Low carbon plants with a capacity of greater than 5MW that intend to opt in to the Capacity Market will need to request written confirmation from Ofgem and the counterparty, in advance of prequalification, that the plant is not applying for or receiving support under the RO, CfD or RHI. Renewable plant with a capacity of less than 5MW that intends to opt in to the Capacity Market will need to request written confirmation from Ofgem that it is not in receipt of the small scale FiT. In both cases, this confirmation must be provided as part of the prequalification application.
757. The amount of capacity which each capacity provider can offer into the auction must accurately reflect the amount of capacity they can offer at times of peak demand. The de-rating process, administered by National Grid, seeks to establish the amount of capacity each plant can be relied upon to deliver. Capacity agreements will be issued and providers paid on the basis of their de-rated capacity rather than their individual 'nameplate' capacity.
758. The question of who carries out de-rating is important. Ostensibly, plant owners have the best information and are in the best position to establish their own de-rating. However, this risks the exercise of market power/gaming – on the one hand, by providers who overstate their reliable capacity because they assess the risk of penalties as low; and on the other, of providers withholding capacity (i.e. bidding below their reliable level, or not participating in the auction at all) in order to force the over-procurement of capacity.
759. The Government's proposal therefore involves the central de-rating of capacity by National Grid, though to minimise the possibility of any disputes this will be carried out using a pre-determined methodology.
760. The de-rating factors for generation plant will be based on a similar methodology as used in the Electricity Capacity Assessment report which Ofgem currently provides and which will form the basis of the analysis that National Grid will provide to the Government each year from 2014. This will ensure consistency between the amount auctioned and delivery of the reliability standard (see Section 4.2.1).

Figure 4.19: Pre-qualification requirements

Requirement	Existing generating unit	Prospective generating unit	Proven CDR unit	Unproven CDR unit	Opting out
General administrative details (e.g. name, contact details & CMU identity)	X	X	X	X	X (abridged)
Solvency certificate ¹³⁵	X	X	X	X	
Legal status & portfolio structure	X	X	X	X	X
Classification of CMU	X	X	X	X	X
Low carbon exclusion status	X	X	X	X	
Ethical conduct declaration	X	X	X	X	X
De-rating factor & connection/CDR capacity	X	X	X	X	X (connection capacity only)
Connection/distribution agreement	X	X (includes distribution offers)			
Evidence of historic performance	X				
Grid Code compliance (or commitment to be compliant)	X	X (refurbishing units only)			
Planning consent (if relevant)		X			
Construction milestone plan		X			
Collateral/ bid bond		X (not for refurbishing units)		X	
Business model (e.g. type of CDR, relationship, procurement strategy)			X	X	
CDR test certificate or test information			X		
Commitment to undergo CDR test				X	
Operational status in delivery year & reasons for statement					X

Note: a refurbishing CMU is one which meets the criteria for **both** existing and prospective generating units

¹³⁵ A declaration by directors that the company is solvent.

761. The mean availability for conventional generation is derived for each BMU, by taking the average of its declared Maximum Export Limit (MEL) figures at real time across the previous seven winter peak periods, and weighting according to each units' maximum declared capacity over the period. The average weighted availability is then calculated for each fuel type and published with a range of minus two standard deviations (i.e. a measure of the variation) as part of the annual Auction Guidelines by National Grid. As part of their pre-qualification submission applicants will be required to select the de-rating factor for their unit/s from this published range (i.e. minus two standard deviations to the mid-point) and apply it to their unit's connection capacity.¹³⁶ The figure selected in pre-qualification will endure for the duration of the applicant's capacity agreement if on a multi-year term National Grid will check whether the selected de-rating figure is within the published range as part of its pre-qualification assessment.
762. The de-rating factors for DSR capacity will be calculated by comparing the declared availabilities of non-balancing mechanism providers of short term operating reserve (STOR), frequency control by demand management, and firm frequency response services to National Grid, relative to their contracted volumes. This data set will be augmented with performance and availability data gathered during the transitional arrangements and during the delivery years of the Capacity Market to ensure DSR providers' de-rated capacity accurately reflects the level of capacity that can be reliably delivered.
763. It is proposed that the relevant fuel-type mid-point (i.e. the average availability), applied to each unit's connection/CDR capacity, will be the volume for which each participating CMU is credited for in the auction ('capacity credit') - irrespective of where in the aforementioned range the CMU has selected its own de-rating figure. This is to enable applicants to select a lower level of obligation according to their own risk appetite whilst aligning the volume procured in the auction with the assumptions made with regards to fuel-type availability in the Electricity Capacity Assessment report. Providers successful in the auction process will receive capacity agreements, and resultant capacity payments, for the level of their selected de-rating factor multiplied by their connection/CDR capacity and not necessarily for the level of their capacity credited in the auction (where, for example, they had selected a de-rating figure lower than the mid-point).

¹³⁶ The Connection Entry Capacity for a transmission connected CMU or the volume stated in the Distribution Connection Agreement for a Distribution CMU.

Section 4.9: Summary of Capacity Market design proposals

Operational phase	Design area	Proposal
Amount of capacity (Section 4.2.1)	When will the first auction and delivery year be?	<ul style="list-style-type: none"> The first auction will be run in November 2014 for delivery of capacity from 1 October 2018 – 30 September 2019.
	How will we decide the amount of capacity to auction?	<ul style="list-style-type: none"> Annual security of supply analysis on the amount of capacity required to meet the reliability standard will be carried out by National Grid and scrutinised by the panel of technical experts. Capacity demand curves will be determined annually by the Government in advance of capacity auctions to enable the trade-off between cost and reliability to be automatically determined at auction. The contribution to security of supply of any ineligible capacity (including interconnected capacity), and plants that opt out of the auction, will be taken into account when setting the demand curves.
Eligibility and pre-qualification (Section 4.2.2, and Section 4.8)	Which forms of capacity will be eligible to participate in the Capacity Market?	<ul style="list-style-type: none"> New and existing generation capacity (including combined heat and power (CHP)). Demand Side Response (DSR), including embedded generation (and with additional transitional support). (see Section 4.3 for more on DSR). Storage. Capacity below a 2 megawatt (MW) <i>de-minimis</i> threshold will only be able to participate when combined with other capacity through an aggregation service. All eligible capacity will be free to participate in both the Capacity Market and balancing services markets.
	Which forms of capacity will be ineligible to participate in the Capacity Market?	<ul style="list-style-type: none"> Capacity receiving any form of low carbon support, including the Renewables Obligation (RO), Contracts for Difference (CfDs), small scale Feed in Tariffs (FIT) and renewable heat incentive (RHI). Initially, interconnected non-GB capacity, and interconnectors themselves, though we will continue work to explore potential solutions that might enable the participation of interconnected capacity in future auctions.
	Will eligible capacity need to be qualified before participating in	<ul style="list-style-type: none"> Pre-qualification will be mandatory for all licenced generators,

	the auction?	<p>to confirm eligibility and bidding status.</p> <ul style="list-style-type: none"> • The amount of capacity each participant can bid into the auction will be determined by National Grid. • There will be a dispute process for participants unhappy with National Grid's assessment of their pre-qualification eligibility.
Auction (Section 4.2.3)	When will auctions take place?	<ul style="list-style-type: none"> • For each delivery year, an auction will be held four years ahead of delivery, supplemented by a further auction one year ahead of delivery.
	How will auctions work?	<ul style="list-style-type: none"> • The auction will be 'pay as clear' – that is, all participants will receive the clearing price set by the marginal bidder. • To mitigate market power, bidders will be classified as either 'price takers' (who cannot set the price) or price makers (who can). Most bidders will default to being price takers meaning they can freely bid up to a predetermined threshold. New entrants and DSR resources will be classified as price makers, and will be free to bid up to the overall auction price cap (set at a multiple of the cost of new entry).
	What length of capacity agreements will be offered?	<ul style="list-style-type: none"> • Existing plants will default to one year capacity agreements unless they require major refurbishment, in which case they may be eligible to access a capacity agreement with a term of up to three years. • New entrants will have access to a longer term agreement for a term they nominate up to a maximum term limit.
Secondary trading (Section 4.2.4)	How will secondary trading work?	<ul style="list-style-type: none"> • Providers can physically trade their obligations from a year ahead of the start of the delivery year where there is additional unencumbered pre-qualified capacity that can take their place. • National Grid will maintain a registry of capacity obligations and National Grid's consent will be required for any physical trading. • Providers will be free to engage in private financial trading at any time.
Delivery (Section 4.2.5)	What will holders of capacity agreements be obliged to do?	<ul style="list-style-type: none"> • Capacity agreements oblige participants to deliver a specified quantity of electricity in system stress periods. • Providers' obligations will be 'load following' (i.e. if a stress event occurs when total demand is at 70% of anticipated peak, they are only required to deliver 70% of their obligation). • National Grid will issue a 'Capacity Market warning' at least 4 hours in advance of any anticipated stress event. • Once a warning has been issued, providers that do not deliver sufficient energy at the relevant time/s of stress to

		<p>meet their profiled obligation will be required to pay a financial penalty. Penalties will not be applied if a warning has not been issued.</p> <ul style="list-style-type: none"> National Grid will have the ability to spot test providers where they have failed to demonstrate their ability to deliver the level of capacity specified in their capacity agreement. Capacity payments will be withheld from any plant which fails a spot test until the plant passes a subsequent test.
	What penalties will apply for failure to meet this obligation?	<ul style="list-style-type: none"> Penalties will be based on the value of lost load to reflect the value to consumers of preventing blackouts. Providers' total penalty exposure in a delivery year will be capped at a proportion of their annual revenue. Rules to create a 'soft cap' will ensure providers always have an incentive to deliver in times of system stress. Providers that deliver more than their load following obligation at times of stress will be paid for their excess delivery at the inverse of the penalty rate.
Payment (Section 4.2.6)	How will capacity payments be covered?	<ul style="list-style-type: none"> The cost of capacity will be recovered from suppliers according to their share of peak demand. Penalties and over delivery payments will be designed to be revenue neutral.
Review and exit (Section 4.7)	Will the Capacity Market be an enduring feature of the electricity market?	<ul style="list-style-type: none"> It may be right to exit the Capacity Market if the underlying electricity market develops sufficiently, particularly through development of greater market liquidity, an active demand side, and more interconnection.
	When will the Capacity Market be reviewed?	<ul style="list-style-type: none"> The need for a Capacity Market will be reviewed every five years.
Institutional arrangements (Section 4.5)	Which organisations will implement and oversee the Capacity Market?	<ul style="list-style-type: none"> The Capacity Market will be put in place by the Secretary of State under the powers conferred by the Energy Bill. The Capacity Market will be implemented by a combination of the Government, Ofgem, National Grid, a settlement body and a settlement agent (Elexon).
Geographic scope (Section 4.5)	What will be the geographic scope of the Capacity Market?	<ul style="list-style-type: none"> The Capacity Market will cover England, Wales and Scotland.

Chapter 5: Ensuring effective and transparent delivery of EMR

764. The Government is committed to ensuring the success of EMR. This chapter deals with policy issues that are designed to ensure that the EMR is delivered in the most effective, robust and transparent manner. It deals specifically with: the transparency of policy intentions via the EMR Delivery Plan and its annual updates; transparency on progress through reporting on EMR and its delivery; action intended to deal with any liability that may arise for the Delivery Body in undertaking this role; and the licence modifications we propose to make to avoid conflicts of interest arising within the System Operator.

Transparency

765. Transparency on EMR policies will lead to confidence and reassurance in our proposals, and will demonstrate the Government's commitment to openness and willingness to work with industry to get the best outcome for EMR.

766. To ensure there is further clarity and openness around the various EMR policies, and to respond to related concerns raised during the Energy Bill's passage through the House of Commons, the Government amended the Energy Bill¹³⁷ to include a duty requiring the Secretary of State to report to Parliament on how the Secretary of State has carried out the EMR functions.

767. In addition to this reporting requirement, the Secretary of State has committed to publishing a number of different reports and a five-year review of EMR¹³⁸. These are outlined below and in Box 5.1.

Box 5.1. Summary of EMR reporting requirements.

Report	Timing of publication
EMR Delivery Plan	Every five years, with the first Delivery Plan commencing in 2013 and covering the period 2014/15 to 2018/19
Annual Updates to the Delivery Plan	Annually, between publication of the EMR Delivery Plans
Annual Reporting Duty	Annually

¹³⁷ Part 2, clause 5 of the Energy Bill (as amended in Grand Committee in the House of Lords)

¹³⁸ See clause 58 of the Energy Bill (as amended in Grand Committee in the House of Lords)

The EMR Delivery Plan

768. In November 2012, the Government set out its intention to publish an EMR Delivery Plan every five years and stated that it will consult on each draft Delivery Plan. The purpose of the Delivery Plan is to confirm Government objectives for the electricity system and to publish key decisions about EMR, for example, strike prices for CfDs.
769. The first Delivery Plan is planned for publication later this year and will set out the strike prices for CfDs for renewables and a reliability standard for the Capacity Market. The Government consulted on these key decisions earlier this year in the draft Delivery Plan¹³⁹ with the consultation closing on 25 September 2013.
770. The decisions to be published in the Delivery Plan will reflect the spending envelope established by the Government: the Levy Control Framework, which sets a cap on the total amount of the levies that can be imposed on consumers through energy bills.
771. The Government also confirmed, in 2012, its intention to publish an Annual Update to the Delivery Plan in the years between Delivery Plan publications. Annual Updates may include:
- Information related to delivery of the EMR mechanisms: the Capacity Market and Contracts for Difference, such as the number and type of contracts allocated;
 - Updated analysis to reflect new information from the market, for example, on technology costs or key assumptions such as fossil fuel prices projections;
 - Any new decisions taken within that period.
772. During the period in which strike prices are set administratively, we intend that each Delivery Plan will be the primary means of publishing strike prices for renewables for the following five-year period. It is not our current intention to use each Annual Update to publish strike prices for the period beyond that which a particular Delivery Plan relates to, although Government may choose to use individual Annual Updates to indicate future strike prices or to provide other updates about the way the CfD budget, within the Levy Control Framework, will be used.
773. To inform the Government's key decisions on EMR, which for the first Delivery Plan includes strike prices for CfDs for renewables and a reliability standard for the Capacity Market, we appointed the System Operator (National Grid), in its role as the Delivery Body for Electricity Market Reform (EMR), to produce analysis and evidence for the Government. In order to carry out the analysis for the Single Electricity Market in Northern Ireland effectively, the

¹³⁹https://www.gov.uk/government/uploads/system/uploads/attachment_data/file/223650/emr_delivery_plan_consultation.pdf

System Operator will work with the System Operator Northern Ireland (SONI) and the Single Electricity Market Operator (SEMO).

774. The first Annual Update to the Delivery Plan is planned for publication in the second half of 2014. Further detail on the contents of this Annual Update will follow in the Delivery Plan later this year.

Independent Panel of Technical Experts

775. To provide further transparency the Government established, in February 2013, an independent Panel of Technical Experts¹⁴⁰. The purpose of the Panel is to impartially scrutinise and quality assure the analysis carried out by National Grid in its role as EMR Delivery Body, the choice of models and modelling techniques employed, the inputs to that analysis (including the ones DECC provides) and the outputs from that analysis scrutinised in terms of the inputs and methods applied.
776. The role of the Panel is a technical function and not a forum for policy commentary or for advising the Government on its objectives for EMR, the policies being implemented or policy decisions surrounding them.

EMR Delivery Plan process

777. The EMR Delivery Plan process has been designed to deliver:
- Decisions by Government that contribute towards EMR objectives;
 - Timely and robust evidence and analysis to support those decisions; and
 - A decision-making process that is appropriately transparent.
778. Through the process, we also need to achieve a balance between:
- Giving certainty to industry in the decisions Government is taking; and
 - Flexibility for Government to retain the ability to take certain decisions as and when necessary.
779. It is vital that both these deliverables and this balance are maintained through the enduring Delivery Plan process. The Government has therefore designed an enduring process which seeks to achieve this and welcomes industry's views on its proposals.

¹⁴⁰ <https://www.gov.uk/government/policy-advisory-groups/141>

780. In order to ensure that the Government obtains the advice and analysis it needs to inform its decisions for a Delivery Plan or an Annual Update, the Government intends to impose an obligation on the System Operator requiring it to provide analysis and to report on progress in delivering that analysis¹⁴¹. By imposing an obligation on the System Operator to provide, for example, the requested analysis by a specified date, the Government can be sure that it will be able to make timely and informed decisions on EMR, and the Delivery Plans and annual updates can be published.

Timing and content of analysis to be commissioned from National Grid

781. The Government's intention is to publish a new Delivery Plan every five years and annual updates in between. However, the precise content of future delivery plans and their annual updates, will need to be determined in due course so that they can evolve as EMR does, for example, as CfDs are allocated on a more competitive basis and as certain information becomes available (such as data on technology costs and the rate of CfD allocations)¹⁴².
782. The Government will ensure that public commissions of analysis from National Grid are timely, enabling, where appropriate, sufficient time for industry consultation and engagement.

Seeking information from CfD generators

783. The main analysis required for the Delivery Plan process uses key assumptions about the electricity market (e.g. forecasts of electricity demand and fossil fuel prices), and electricity generation technologies (e.g. costs of generation, such as build, capital and operating costs). Some of these may be provided by DECC, some with National Grid's input or advice and some directly by National Grid, including via market participants, such as generators.
784. The System Operator, in October 2012, launched a Call for Evidence¹⁴³ to support the development of CfD for renewable technologies. While the System Operator received over 70 responses to the consultation there was no guarantee that the System Operator would receive robust information and evidence from the relevant parts of industry. If the Government is to be confident in the decisions it is taking on EMR, for example, in setting 'bankable' and affordable CfD strike prices for renewable technologies or the volume of

¹⁴¹ See clause 13 of the Energy Bill which enables the Secretary of State to make regulations about this in relation to the CfD policy. A similar power can be found in clause 27 which enables the Secretary of State to make regulations about obtaining information in the Capacity Market context.

¹⁴² Accordingly, we expect regulations made under clause 13 to set out the times by which information must be provided to the Secretary of State. For some requirements the timing requirements may be specific, whilst in others there may be more flexibility to reflect the approach described above.

¹⁴³ <http://www.nationalgrid.com/uk/Electricity/Electricity+Market+Reform/>

capacity to procure through a capacity auction, it needs to be confident that the Delivery Plan process, including the System Operator’s evidence base, is as robust as possible.

785. The Government’s view therefore is that the System Operator needs to be given the “right tools for the job”, for which it will be held accountable by Ofgem (see the following section). The Government therefore considers it appropriate to create, using the powers in clause 13 (Information and advice) of the Energy Bill, an obligation on CfD generators (“a generator who is party to a CfD”) to provide the System Operator with certain information, including build, capital and operational costs of CfD plant.
786. The Government is mindful that CfD generators may be cautious about such information provisions, owing to potential conflicts of interest between the System Operator in its commercial role and its role as EMR Delivery Body. The Government is confident, however, that any potential conflicts can be managed and that information will be strictly safeguarded. The following section sets out how we intend to implement the mitigation measures. We consider these provisions, along with the potential to use regulation for the protection of confidential or sensitive information and the measures to address conflicts of interest that were announced in April (and which will be implemented using our licence modification powers in the Energy Bill) will be satisfactory in these circumstances. We welcome industry’s views on this issue (see consultation questions).

Holding the System Operator to account

787. With such a vital role, it is paramount that the System Operator is held to account in its role as EMR Delivery Body. We consider that Ofgem is best placed to hold National Grid to account for delivery of the analysis by monitoring and enforcing (using the powers in clause 16 (Enforcement for CfD) and clause 30 (enforcement for Capacity Market) the regulations made under clause 13 and clause 27 of the Energy Bill as “relevant requirements” for the purposes of section 25 of the Electricity Act 1989.
788. The Panel of Technical Experts will continue to play a key role in scrutinising the analysis undertaken by the System Operator, which includes taking a view on the quality of that analysis. The PTE will continue to publish reports in accordance with their remit as set out in their Terms of Reference¹⁴⁴. To avoid duplication, we do not propose that Ofgem should have a role in scrutinising or monitoring the quality of the analysis undertaken by the System Operator in its EMR Delivery Body role. Ofgem’s role is therefore proposed to be limited to regulating whether the System Operator has carried out the analysis and followed the correct processes.

¹⁴⁴https://www.gov.uk/government/uploads/system/uploads/attachment_data/file/88201/Terms_of_Reference_for_EMR_Panel_of_Technical_Experts_-_PDF.pdf

Enduring Delivery Plan process	
Question DP1	Do you agree the proposals here achieve the right balance between providing certainty to industry protection of commercial information and providing the right degree of flexibility to the System Operator and Government?
Question DP2	Do you agree that it is appropriate for the System Operator to have access to relevant information from CfD generators in order for it to fulfil its analytical and advisory functions as EMR Delivery Body?
Question DP3	Do you agree that it is appropriate for National Grid to require cost information from CfD generators to provide cost information to the System Operator in order for it to deliver its role as EMR delivery body and to enable the Secretary of State to take informed decisions which will impact on the affordability and “bankability” of CfD strike prices?

Publications to be laid in Parliament to provide transparency

Annual Reporting Duty and Annual Energy Statement

789. At Commons Report stage the Government introduced clause 5(4) in to the Energy Bill to create transparency relating to EMR policies. The clause requires the Secretary of State to report, before 31 December each year and beginning in 2014, on how he has carried out his functions in part 2 of the Bill in order to deliver the objectives. The report must be laid in Parliament and be shared with the Devolved Administrations.
790. Part 2 includes: Contracts for Differences, Capacity Market, Investment Contracts, Conflicts of Interest and Renewables Obligation Transitional provisions.
791. The report will provide Parliament and stakeholders the opportunity to scrutinise the Government’s achievements on EMR, and will also provide assurances on transparency and accountability to Parliament.

792. The Government intends at this stage to use the Annual Energy Statement (AES) - which reports on the progress DECC has made on a number of its policy areas – to fulfil this reporting requirement.

DECC Annual Report

793. The departmental Annual Report focuses on the department's performance and policy making. The Report is scrutinised by the House of Commons' Energy and Climate Change Committee which holds an oral session at the end of the year, which is attended by the Secretary of State and Permanent Secretary.

Liability Shield for the EMR delivery body

794. This section sets out proposals we intend to deal with any liability that may arise for the Delivery Body in undertaking its role, in order to ensure effective and robust delivery of the EMR functions.

Background

795. In its role as Delivery Body, the System Operator, National Grid will be responsible for functions such as: providing analysis to Government to support policy decisions, administering the allocation process for CfDs and administering and running the capacity auctions for the Capacity Market. National Grid has been selected to be the EMR Delivery Body because of its expertise and experience. This, coupled with the fact that it is already at the very heart of our energy system¹⁴⁵, makes it best placed to perform this role. The appointment of National Grid as the delivery body is an innovative approach; an approach that will use private sector know-how to help lower costs for taxpayers, consumers, and industry.
796. National Grid currently holds an electricity transmission licence granted under section 6(1)(b) of the Electricity Act 1989. This licence enshrines the rights conferred and obligations imposed on National Grid in its roles as national system operator and the owner of transmission assets in England and Wales. The new EMR Delivery Body functions outlined in chapters 3 and 4 of this consultation will be conferred on National Grid by a mixture of Regulations (Capacity Market and CfD), Capacity Market Rules and licence modifications. The obligations imposed on National Grid as the EMR Delivery Body will be enforceable as "relevant requirements" under the Electricity Act 1989 and enforced by Ofgem.

¹⁴⁵ National Grid owns and maintains the high-voltage electricity transmission system in England and Wales, together with operating the system across Great Britain, balancing supply with demand on a minute by minute basis.

797. Although this consultation sets out the Government's proposals for the design of EMR, until final policy decisions are made it is difficult to foresee all of the risks which might arise when National Grid is performing its Delivery Body functions. To help manage the risks which may arise, the Government has agreed to consider the extent to which National Grid should be "shielded" from liability in damages for anything done or omitted whilst exercising its EMR Delivery Body functions¹⁴⁶.

Scope of the power to shield National Grid as delivery body

798. Clause 55 gives the Secretary of State the power to protect National Grid, its directors, employees, officers or agents against a claim for damages made by a third party where National Grid is alleged to have caused the third party loss as a result of carrying out its EMR delivery body functions.
799. The clause enables the Secretary of State to exclude from the shield instances where National Grid has acted in bad faith, acted unlawfully (by breaching human rights) or where National Grid is in breach of an enforcement order made by the regulator, Ofgem, under its powers in the Electricity Act 1989 (see subsection (3) of clause 55).
800. The power conferred by Clause 55 to apply a liability shield is not unprecedented. Bodies carrying out public functions are sometimes protected from civil claims for damages. Although using a private company to deliver a public function has few precedents, there are similar provisions in place for some public bodies carrying out statutory functions, for example the (former) Financial Services Authority and the Pensions Regulator.
801. The application of a liability shield to some or all of National Grid's EMR functions will not protect it from complaints, nor deny people other forms of redress against its decisions. For example, both the Capacity Market and CfD functions will have appeals processes to help resolve issues arising between National Grid and others affected by the exercise of its EMR delivery body functions. It is important to note therefore that the shield, if applied, will only protect National Grid or its directors, employees etc. from liability in damages.

Procedural safeguards

802. If the Secretary of State decides not to confer protection in the form of a liability shield in respect of one or more of National Grid's EMR Delivery Body functions, Clause 55(4)(b) requires the Secretary of State to provide a public written statement outlining his reasons.

¹⁴⁶ Clause 55(2) defines a relevant function as a function conferred by or by virtue of Chapter 2, 3 or 4.

This procedural safeguard ensures that a transparent system is in operation and should help National Grid and relevant stakeholders see where National Grid is operating with the benefit of a liability shield.

803. The Government has given assurances to Parliament that there would be careful consideration given to the application of the liability shield in order to ensure, amongst other things, that the application of the shield does not have the effect of diluting incentives for good performance and provides value for the consumer.
804. Whilst the final design of EMR – and therefore the functions National Grid will be performing – is now beginning to take shape through the proposals in this consultation, the design is not yet complete. Accordingly, it is difficult at this stage to perform a complete analysis of which EMR Delivery Body functions might properly sit behind a shield. A complete analysis will only be possible once all of the final policy decisions have been made. At this stage, however, it is possible to set out the two approaches which the Secretary of State might adopt to determine how to exercise the power to apply a liability shield and look at the benefits of each. The two approaches that might be taken are:

- (1) the Secretary of State could take the view that the shield should be applied to all of National Grid's EMR Delivery Body functions given the existing regulatory framework that will govern the performance of such functions or;
- (2) the Secretary of State could take the view that the power to apply a shield should be exercised on the basis of a set of guiding principles which may result in some or all of the Delivery Body functions being protected from a claim for damages.

We have set out in turn how we envisage each of the two proposed options working in practice and welcome stakeholder views on which of these two approaches strikes the right balance between ensuring National Grid performs its EMR Delivery Body functions to the highest standards and delivers value to consumers and ensuring that any change in National Grid's risk profile does not lead it to perform its EMR functions in a defensive manner, a manner which does not lead to the achievement of EMR policy objectives or value for money.

Application of the Liability Shield to all of National Grid's EMR Delivery Body Functions

805. We have set out below the policy justifications that could be made for the application of the liability shield to all of National Grid's EMR Delivery Body functions.

(a) National Grid is sufficiently incentivised through the existing regulatory regime, including the existing licence enforcement mechanism, and the price control mechanism to fully comply with and discharge its EMR Delivery Body functions

806. As stated above, a consequence of the electricity market reforms is that functions will be conferred on National Grid and these will be enforceable as “relevant requirements” by Ofgem. Ofgem will also be responsible for ensuring that National Grid fully complies with and appropriately discharges its EMR Delivery Body functions in an economic and efficient manner.
807. The additional costs incurred by National Grid in its EMR Delivery Body role will be addressed by Ofgem, building on the existing price control and system operator incentive regimes that apply to National Grid in order to provide for appropriate EMR related cost recovery and performance incentives. The existing Ofgem cost recovery regime operates so that payment is based on meeting clear objectives and where an incentive payment can be made in the case of over performance. In cases of poor performance Ofgem can claw back expenditure. This will ensure economic and efficient performance of the EMR Delivery Body functions and the delivery of value for money to consumers. Ofgem will be consulting in due course on proposals for amending the relevant price control provisions within National Grid’s transmission licence in order to take account of the new EMR Delivery Body role.
808. National Grid’s EMR Delivery Body functions will become relevant requirements and, as a consequence, will be enforceable by Ofgem. Accordingly, National Grid will be exposed to the same obligations to comply with these EMR Delivery Body conditions and requirements as apply in respect of its existing transmission activities. The sanctions available to Ofgem where non-compliance with a licence is identified are set out in the Electricity Act 1989. These sanctions allow Ofgem to impose enforcement orders which require corrective behaviour to be implemented to ensure compliance and / or impose financial penalties for licence breaches. Ofgem is entitled to impose a financial penalty of up to 10% of the licensee’s turnover for every breach found.
809. The obligation to comply with an enforcement order is, by virtue of section 27(4) of the Electricity Act 1989, a duty owed to any person who may be affected by a contravention of the order. This means that where a licensee fails to comply with an enforcement order any person who suffers loss or damage as a consequence is entitled to bring proceedings against the licensee in respect of the breach of that duty in order to recover the loss or damage suffered.
810. Ultimately, under the terms of National Grid’s transmission licence, if Ofgem were to issue an order for compliance or impose a financial penalty, failure by National Grid to comply with that order or to pay a financial penalty can lead to the revocation of the licence. Non-compliance with licence obligations is therefore an extremely serious matter with harsh sanctions. The regulatory duty to comply with the licence is enforced by Ofgem but the existing statutory provisions under section 27(4) of the Electricity Act 1989 also provide a

remedy to any person who suffers loss or damage as a consequence of any non-compliance with an enforcement order. Under the existing regime a third party who suffers loss or damage as a result is also entitled to bring a separate cause of action against National Grid in damages for such loss.

(b) National Grid could be exposed to an uncertain level of risk – and this may lead to defensive performance of its functions – impact on value for money.

811. National Grid's existing transmission business is exposed to a known level of liability in terms of the consequences of failing to comply with licence obligations and the business is remunerated, incentivised and conducted with those known risks in mind. An uncertain level of risk might lead to the defensive performance of EMR functions which might result in less than efficient outcomes and may not deliver value for money. Accordingly to avoid this outcome it might be argued that it is preferable that National Grid's overall risk profile in terms of exposure to liability in damages is not impacted as a consequence of it being appointed as the EMR Delivery Body and performing the associated functions as transmission licence obligations.
812. The precise nature of the relevant EMR Delivery Body functions to which the exemption from liability under clause 55 will apply is not yet known since the current policies in respect of both the capacity mechanism and the CfD (and hence the associated EMR Delivery Body functions) are still being finalised. However, once finalised and enshrined within the mixture of Regulations (Capacity Market and CfD), Capacity Market Rules and licence modifications the functions will all be within the scope of the exemption. Given the above regulatory structure and the sanctions and remedies that it gives rise to it may be appropriate that the exemption from liability in damages (subject to the prescribed exceptions) provided for by clause 55 is applied to all of National Grid's EMR Delivery Body functions. It could be argued that such an approach will not inappropriately shield National Grid from liabilities that may arise from its EMR Delivery Body performance but would ensure a consistent approach to the liabilities that may arise as a consequence of non-compliance with the relevant requirements. It would also ensure that National Grid's overall risk profile in terms of exposure to liability in damages is not impacted as a consequence of it being appointed as the EMR Delivery Body and performing the associated functions as licence obligations.

Function by function approach to applying the Liability Shield

Introduction

813. As an alternative to the application of the liability shield to all of National Grid's EMR Delivery Body functions as described above, the Secretary of State could consider whether to exercise the power in clause 55 by examining each function that National Grid performs and determining whether the type of function is one that as a matter of public policy it is

appropriate to expose National Grid to the risk of liability for damages. We propose using a set of principles as described below which set out the categories of functions that National Grid are likely to perform to determine whether or not the liability shield should be applied. The function by function approach would not always lead to liability on the part of National Grid; rather some of National Grid's functions will be protected by the liability shield.

Policy justifications for the function by function approach

814. The function by function approach takes into account the fact that National Grid, as the national system operator, would be regulated by Ofgem and subject to financial penalties, enforcement orders and the possible revocation of its licence. This regulatory regime should act to incentivise good performance on behalf of National Grid. Under the current regime, in instances of a licence breach, a third party could bring a tortious or contractual claim against National Grid for damages. Therefore, it is arguable that providing National Grid with an exemption from liability in damages in respect of all of its EMR delivery body functions would expose National Grid to a lower level of risk liability than it faces at present in respect of a failure to comply with the existing regulatory obligations within its transmission licence.
815. As previously outlined, an argument in favour of the application of the shield to all EMR delivery body functions is that National Grid could be exposed to an uncertain level of risk and this may lead to defensive performance of its functions. However, it is arguable that National Grid's risk profile would not in fact change under the proposed reforms. According to the function by function approach, if National Grid perform administrative tasks which give rise to a third party claim for damages it should be liable. This approach mirrors the current enforcement regime whereby third parties can establish a separate cause of action for damages against National Grid.
816. The function by function approach is designed to ensure that National Grid is protected against the risks of claims being made against it for damages where the risk is created by Government policy as opposed to a decision which National Grid will make. The principles also seek to ensure that incentives for good performance are not removed and any protection conferred on National Grid can be justified as providing value to the consumer.¹⁴⁷

The 4 principles

- 1) The interpretation of government policy by National Grid should not lead to a risk of liability;

¹⁴⁷ Existing controls to ensure good performance and value to the consumer include a) Ofgem cost recovery regime b) The risk that Ofgem will take action for breach of licence conditions or relevant requirements and the potential loss of any incentives under the SO incentive regime, and fines of up to 10% of turnover c) The risk that National Grid can be sued d) The exclusions to the shield e) National Grid's reputational risk

- 2) The application of government policy by National Grid should not lead to a risk of liability;
- 3) If a function conferred upon National Grid requires the exercise of discretion no risk of liability should arise; and
- 4) If the function relates to the performance of administrative activities then it should be possible to hold National Grid liable.

817. Principles 1-3 are illustrations of when the Secretary of State **not** National Grid should be challenged if a third party is minded to bring a claim in damages. We consider that as a matter of policy the first three principles are instances of decisions for which the Secretary of State should be held responsible for, not National Grid. In respect of principle 4, we consider that it would be inequitable for a third party to suffer loss and not be able to pursue National Grid for damages since under the current regime third parties are able to do so.
818. The four guiding principles are discussed below with reference to specific worked examples of possible functions based on our current understanding of the Capacity Market and CfD policy.

Principle 1 - the interpretation of government policy should not lead to liability in damages

819. We are mindful of the risk that while Government sets policy the Delivery Body carries a risk associated with interpreting the policy intent since it is a private company being directed by, for example, legislation what to do. The interpretation of policy in legislation which binds National Grid might be considered to be a form of discretion and we should seek to avoid multiple interpretations of policy. Therefore, in recognition that the responsibility to be clear as to the intent of policy lies with Government we propose that no risk of liability should arise where National Grid needs to interpret Government policy decisions.
820. For example, National Grid must prepare an annual electricity capacity report which must include recommendations as to the target volume and the demand curve that should be used in a T-4 auction in the following auction window. National Grid must make any recommendation for the purposes of the report in accordance with the directions and using the assumptions given by the Secretary of State under the Electricity Capacity Regulations. The assumptions and directions are set by Government and we propose that if they are properly applied by National Grid and this leads to a claim for damages against it, no liability should arise.
821. We propose that where National Grid's role involves a substantial amount of policy interpretation it should, where possible, seek clarification or direction from Government but should not be at risk of being sued for losses by third parties.

Principle 2 – the application of government policy should not lead to liability in damages

822. Government has stated publicly that it will retain responsibility for policy. However, there are instances where that policy may be informed by the work of the EMR Delivery Body. Therefore, it is proposed that where Government signs off, approves or has ultimate responsibility for decisions taken, then National Grid should be shielded from any liability which arises as a result of National Grid performing its functions in a way required by Government. Again, we consider that National Grid as a private company should not be held liable for damages if it is applying Government policy and Government has directed it through, for example, legislation what to do.

Principle 3 – if a function conferred upon National Grid requires the exercise of discretion no liability in damages should arise

823. Overall, it is Government's intention that National Grid's role should be largely mechanistic involving little or no discretion. This places a requirement on Government to ensure that rules, regulations and other guidance available to market participants are clear and the processes unambiguous.
824. Therefore, where a function conferred upon National Grid requires discretion to be exercised we propose that there should be no risk of liability in damages as a result of exercising that discretion.
825. For example, we expect that the Delivery Body will provide evidence and analysis to inform CfD strike price setting, provide security of supply analysis to inform Government's decisions on the Capacity Market and a range of other analysis in respect of EMR. Decisions based on the advice will ultimately be taken by the Secretary of State. Therefore there is a relatively low risk of a third party bringing a claim for damages against National Grid in respect of the advice it provided to the Secretary of State. However, we cautiously accept that the interpretation by National Grid of analytical modelling outputs could be considered a task which contains some discretion and as such the Secretary of State might propose to apply a shield around such a function unless the application runs contrary to the principles set out here.

Principle 4 – if the function relates to the performance of administrative activities, National Grid should be at risk of being found liable for a claim in damages

826. There is an important distinction to be made between discretion and risk management. Where the Delivery Body, as part of its general business, has the ability to control its

exposure to claims for damages it is proposed that the application of the shield would be inappropriate.

827. For example, when valuing CfD contracts we expect that Government will determine both the formula for the calculation and provide the data necessary to undertake that calculation. In this example, the only error that we can reasonably foresee might occur is if National Grid incorrectly input data. It is arguable that such a risk is within the ability of the Delivery Body to control through quality assurance processes and the checking of inputs. Therefore where National Grid has the ability to manage such errors it is proposed that the application of the shield would be inappropriate. Also for the CfD allocation process, in the event the eligibility check is failed, the Delivery Body will notify the applicant of this and the reason for the failure. The provision of that notification is an administrative task and it arguable therefore that it does not require liability protection.
828. Therefore, we propose that the performance of administrative activities by National Grid should give rise to claims in damages and therefore should not require a shield. That is, tasks or processes undertaken by National Grid, which do not involve discretion or interpretation, require no liability protection. For example, National Grid will be required to maintain a central registry for the Capacity Market of individual Capacity Market Units (CMUs) with an agreement, and confirm in writing to applicants that they have been successful in securing a Contract for Difference. These activities are administrative and we propose should give rise to liability claims.
829. Also, for the CfD allocation process, in the event that the eligibility check is failed the Delivery Body will notify the applicant of this and the reason for failure. The applicant may decide to appeal the decision which may or may not result in it being overturned. Accordingly, it seems to be more in the way of an administrative task and it is arguable therefore that it does not require liability protection.
830. The current policy in respect to both CM and CfD is not finalised; it will be finalised after this consultation has closed and its responses considered. It is only then that an exhaustive list of National Grid's delivery body functions can be compiled and analysed to see which of those functions warrant protection against a claim for damages. Therefore, we can only provide examples here relying on the functions as they are currently understood. When the policy is finalised, post consultation, the nature of functions used in the examples may change. Accordingly, the examples should not be relied upon as indicating that a shield will or will not apply to that particular function. Instead, what is important is to ensure that the principles upon which the shield might be provided are robust.

<p>Question DP4</p>	<p>Do stakeholders have any views on whether the principled approach should be the preferred approach? Or do stakeholders feel there is merit in adopting the approach whereby the liability shield is applied to all of National Grid's EMR Delivery Body functions?</p> <p>Do stakeholders feel that there are other good reasons for supporting the principled approach or the approach whereby the liability shield is applied to all of National Grid's EMR delivery body functions? Please provide reasons for your views.</p>
---------------------	--

Modifications to National Grid's licence to implement mitigation measures to manage Conflicts of Interest

831. In line with Government's commitment to ensure that EMR is implemented in the most transparent and robust manner possible, this section explains the policy implementation of the proposals to avoid conflicts of interest arising within the System Operator (National Grid, or NGET) through business separation measures in NGET's licence. These proposed licence modifications follow from the conflicts of interest report published jointly by the Government and Ofgem in April 2013, following two public consultations.

Background

832. When National Grid was designated as the EMR Delivery Body, it was acknowledged that, as well as synergies, there was the potential for conflicts of interest to arise between National Grid's existing activities and the new EMR role. We announced in the EMR Technical Update¹⁴⁸ that the Government and Ofgem would work together to assess these potential conflicts of interest and propose mitigating measures, if these were shown to be necessary.

833. The project reported in April 2013¹⁴⁹, following two consultations held jointly by Government and Ofgem¹⁵⁰, extensive stakeholder engagement and informed by independent analysis by KPMG. The project concluded that the risk of conflicts of interest being acted upon by National Grid was relatively low. If they were to be acted upon, however, the potential effect in cost terms and the importance of maintaining stakeholder confidence in EMR meant that some proportionate mitigation measures were justified.

834. In drawing conclusions the Government and Ofgem considered the following policy objectives:

- Minimise the risk of conflicts of interest arising;
- Ensure the effective and efficient delivery of EMR by maximising synergies with the System Operator's existing role; and

¹⁴⁸ https://www.gov.uk/government/uploads/system/uploads/attachment_data/file/48253/3884-planning-electric-future-technical-update.pdf

¹⁴⁹ Final report published here: https://www.gov.uk/government/uploads/system/uploads/attachment_data/file/191731/EMR_Conflicts_of_interest_consultation_final_report_FINAL_P_.pdf

¹⁵⁰ An open letter was published jointly by Ofgem and Government on 8 March 2012, which can be found alongside the response at <https://www.gov.uk/government/consultations/reforming-our-electricity-market>. This was followed by a full public consultation published 22 November 2012, published by the Government and Ofgem alongside introduction of the Energy Bill into Parliament, this and the response published on 22 April 2013 can be found at <https://www.gov.uk/government/consultations/synergies-and-conflicts-of-interest-arising-from-the-system-operator-delivering-electricity-market-reform-emr>.

- Ensure investor and industry confidence in the EMR delivery arrangements.

835. The mitigations proposed in the project report to meet these objectives were as follows:

- To minimise, through the **design of EMR**, the risks of conflicts of interest arising, through transparency, scrutiny and limits on the SO's discretion.
- The **proportionate ring-fencing of some of the EMR functions** within NGET and from other National Grid businesses to further mitigate the risk of conflicts of interest in a way that allows key synergies to be realised whilst providing protection for commercially sensitive information.
- Additional **protection for commercially sensitive information** submitted to the SO for the delivery plan analysis, through creation of a data handling team and associated non-disclosure rules.
- Ensure that regulation provides for appropriate managerial, information, physical, employee, and legal **separation of certain National Grid 'competitive businesses' from NGET** which present potential conflicts of interest with the EMR delivery role.

836. We are now implementing these measures as set out below.

Mitigation through the design of EMR

837. On the basis of the two stakeholder consultations and independent analysis, The report committed to the following measures to be implemented through the design of EMR, as set out elsewhere in this document:

- **Transparency and scrutiny:** The analysis that National Grid provides as part of its delivery functions will be subject to scrutiny by a Panel of Technical Experts and public consultation to ensure that the analysis is high quality and objective.
- **Limits on discretion:** National Grid will be expected to run mechanistic processes under rules clearly and transparently set out by Government or Ofgem. Government will ensure that where discretion is required to ensure the effective delivery of EMR, it is within transparent, clear parameters and that participants have a route for redress, for example via appeals processes.
- **Governance and accountability:** National Grid will operate within a governance and accountability framework ensuring its performance is measured and that its EMR activities are run economically and efficiently.

Mitigation through ring-fencing of EMR functions, protection of commercially sensitive information and business separation

838. We intend to implement the business separation measures set out above using our proposed powers in chapter 5 of the Energy Bill, which enable the Secretary of State to make modifications to NGET's transmission licence.
839. The measures will be implemented through a set of "EMR" modifications to NGET's transmission licence which will set out the following:
- An overarching requirement that NGET carry out the EMR functions conferred on it having regard to stated objectives. These objectives are:
 - the efficient and effective carrying on of the EMR functions;
 - compliance with the principles appearing to it to represent best regulatory practice; and
 - that none of NGET's businesses, nor those of any of its affiliates¹⁵¹ or related undertakings¹⁵², obtains an unfair commercial advantage or is favoured by the way in which the EMR functions are exercised.

The intention of these objectives is to ensure that NGET is focused on delivering the outcomes rather than just complying with processes required by the licence condition. The objectives mean NGET must prevent unfair advantages to itself or other businesses in NG Group Plc resulting from its EMR role. The objectives also ensure NGET achieves its business separation in a way that will best retain synergies and deliver value for money.

- A confidentiality obligation in respect of data received by NGET for the purposes of carrying out EMR analysis for the EMR delivery plans and annual updates. This will quarantine the raw data, submitted by industry, from analysts in the SO that will be working on both EMR and wider analysis for NGET other functions such as network planning. It will require the information to be handled securely and stored separately. It will also require staff working in this data handling role to sign non-disclosure agreements and to be subject to limitations on their ability to work for certain other parts of NGET or National Grid businesses.
- A requirement to establish and maintain a physically separate team to carry out EMR 'administrative' functions. These are functions that relate to the allocation of CfDs and running the Capacity Market auction, including pre-qualification. The members of this team will sign a non-disclosure agreement, and will be subject to limitations on their ability

¹⁵¹ "Affiliate" is defined in the Standard Conditions to mean "any holding company of the licensee, any subsidiary of the licensee, or any subsidiary of a holding company of the licensee."

¹⁵² "Related undertaking" is defined in the Standard Conditions to mean "any undertaking in which the licensee has a participating interest."

to work for other parts of NGET or National Grid Group businesses. As with the data handling provision above, this will prevent raw data being accessed by wider teams within NGET and to ensure that all reasonable steps have been taken to anonymise the data. Further, this measure should foster a separate team identity for these EMR functions within the SO and reduce the risk of conflicts occurring.

- A prohibition on the disclosure of confidential EMR information acquired, obtained or derived in whole or in part from performing EMR functions outside of the System Operator. This seeks to stop information being passed outside of the System Operator to the Transmission Owner part of NGET or to other National Grid businesses, particularly from System Operator analysts. This prevents these businesses gaining any unfair advantage over the rest of the market. It will be implemented through appropriate IT measures and a staff code of conduct.
- An express obligation to establish and maintain legal, managerial, employee, physical and information separation between NGET and appropriate competitive businesses. This will guarantee that those competitive businesses identified in our analysis as having the most material conflicts¹⁵³ will be appropriately separated from NGET to minimise the risk of such conflicts of interest being acted upon.
- A requirement for a compliance statement describing, and for an appropriate responsible director to sign an annual certificate of compliance with, the practices, procedures and systems applicable to the EMR conflict mitigation measures specified above, supported by a requirement for external review and reporting. This statement will set out the steps NGET has taken to comply with these requirements and how it has sought to meet the objectives, and will identify any additional measures that may have been found to be necessary. The form of this statement will be agreed by the regulator, Ofgem, and will be available for public scrutiny.

Figure 5.1 below gives a visual representation of the effect of these measures:

¹⁵³ Interconnectors, Offshore Transmission and Carbon Capture and Storage

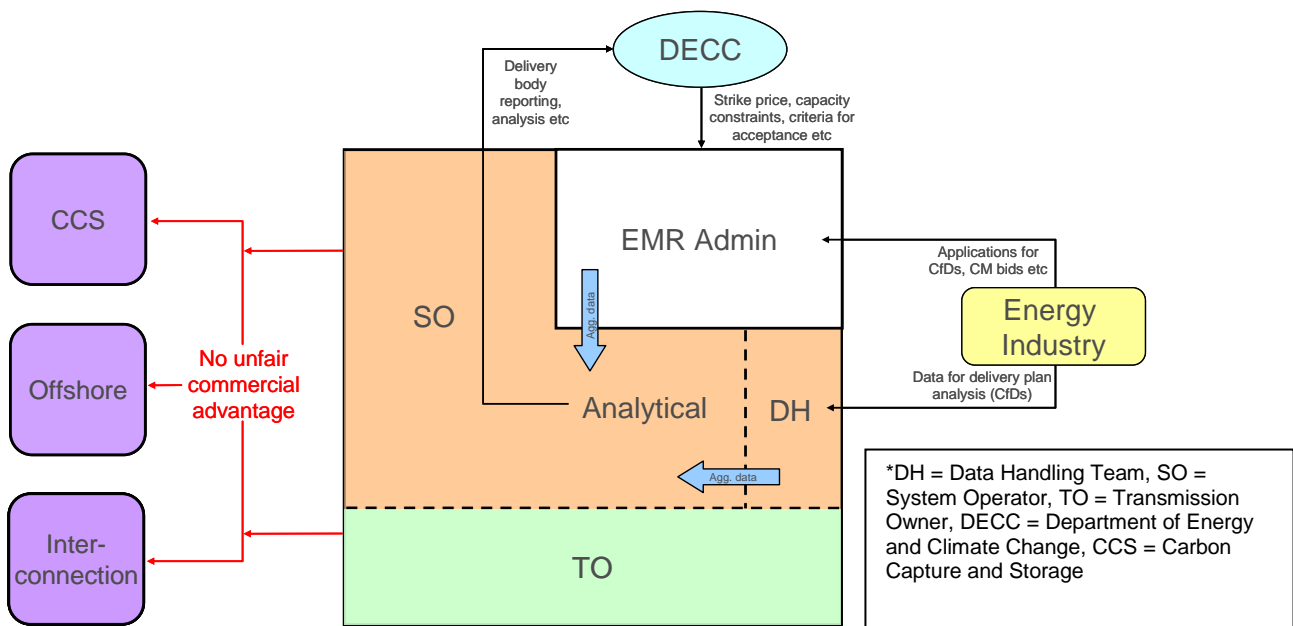

840. These mitigations meet the objectives set out above by:

- Minimising the risk of conflicts of interest arising by ensuring that all information received for the purposes of carrying out EMR delivery is protected and that this is, where appropriate, supported by physical, managerial and employee separation.
- Ensuring the effective and efficient delivery of EMR by maximising synergies with the System Operator's existing role, for example in relation to the delivery plan analysis that the System Operator will carry out and ensuring that the mitigations are proportionate to the risk.
- Ensuring investor and industry confidence in EMR by providing the necessary protections are transparently set out in NGET's transmission licence where they will be enforced by Ofgem. NGET's compliance with them will be subject to an annual reporting requirement.

841. We are seeking views in this consultation on the implementation of these measures. Draft licence modifications have been published alongside the consultation.

842. Further detail on the project undertaken by the Government and Ofgem to look into potential conflicts of interest, including findings, the analytical approach to identifying and assessing conflicts of interest and synergies¹⁵⁴, evidence gathered during the process, including

¹⁵⁴ <https://www.gov.uk/government/consultations/synergies-and-conflicts-of-interest-arising-from-the-system-operator-delivering-electricity-market-reform-emr>

consultation responses¹⁵⁵ and the Impact Assessment¹⁵⁶ can be found on the DECC website. These may be useful reference for when considering your response to the questions below.

Box 5.4: Consultation questions:	Policy Issue
Question DP5	<p>How effectively will the licence modifications achieve the mitigation proposals set out above?</p> <p>Please explain your answer, providing evidence where you can.</p> <p>Are there any unintended consequences you can foresee from these modifications?</p>

¹⁵⁵ <https://www.gov.uk/government/consultations/synergies-and-conflicts-of-interest-arising-from-the-system-operator-delivering-electricity-market-reform-emr>

¹⁵⁶ <https://www.gov.uk/government/consultations/synergies-and-conflicts-of-interest-arising-from-the-system-operator-delivering-electricity-market-reform-emr>

Chapter 6: EMR in the Devolved Administrations

Introductory section

843. Our aim is that a clear and consistent approach to incentivising investment in low carbon generation is applicable and usable by all financiers and investors, and beneficial to all UK consumers. It is by harnessing natural resources and technical expertise from across the UK that we will be able to deliver the required new generation of secure low-carbon power.
844. We recognise that within Northern Ireland, Scotland and Wales are located significant parts of the UK's low carbon generation capacity, including substantial potential onshore and offshore renewable resources. Investors and developers are committed to developing future low-carbon generation in each of these nations.
845. Timely, proportionate and transparent engagement with the Devolved Administrations is therefore important to the successful development and delivery of EMR. The Northern Ireland Executive, Scottish and Welsh Governments have been closely involved in discussions on EMR and we will continue to work closely and collaboratively with them as this package of measures develops from legislation to practical implementation.
846. The draft strike prices published for consultation are underpinned by analysis conducted by DECC, National Grid and the System Operator Northern Ireland, and analysis has been shared and discussed with the Devolved Administrations through the Devolved Administration Consultation Group. We will continue to develop this engagement before the strike prices are set in the final delivery plan.
847. To ensure the engagement of the Devolved Administrations is clear and sustained following the passage of the Bill, we are in the process of drawing up a Memorandum of Understanding. This MOU sets out an agreed framework for the Government and the Devolved Administrations will work together to implement the powers and functions contained within the Act, subject to Royal Assent.
848. The aim of the MOU is to promote close and effective working relationships and good communications at all levels between the participants, and to foster a spirit of constructive co-operation. It is intended to be consistent with the principles outlined in the Memorandum of Understanding and Supplementary Agreements between the UK Government, Scottish Ministers, Welsh Ministers and the DETI Minister for Northern Ireland¹⁵⁷.

¹⁵⁷ Department of Enterprise, Trade and Investment

849. A high-level description of the role of the Devolved Administrations in EMR is set out below.

Northern Ireland

850. Energy policy is devolved to the Northern Ireland Executive, with the exception of most elements of nuclear power. The Northern Ireland Executive has agreed that extension of the CfD, 'Investment Contracts' and Emissions Performance Standard (EPS) provisions will apply to Northern Ireland, while taking into account both devolved competencies and Northern Ireland's position within the Single Electricity Market.
851. The UK Government and Northern Ireland Executive have also agreed that as Northern Ireland is part of the Irish Single Electricity Market the Capacity Market will only apply across Great Britain with any associated costs being borne by GB customers.
852. The CfD will be introduced in Great Britain first, with Northern Ireland opening its market to CfDs from 2016. We envisage that the first payments under EMR for generators in Northern Ireland will flow from April 2016 with the first contracts for Northern Ireland being capable of being signed from late 2015. The supplier obligation will not be levied in Northern Ireland until 2016, at which point Northern Ireland generators are capable of benefitting from the regime.
853. We will continue to work with Department of Enterprise, Trade and Investment in Northern Ireland on their decision on applying these strike prices in Northern Ireland, as part of our efforts to ensure a coherent UK-wide system for supporting low-carbon generation.
854. Northern Ireland Ministers will be asked to consent to the CfD strike prices proposed for Northern Ireland. The Secretary of State will make provision in secondary legislation enabling Northern Ireland Ministers to set strike prices at a different level if they cannot consent to those proposed, but any additional costs would not be socialised across the UK. Strike prices in Northern Ireland may be different to those in GB to reflect any differences in the market. We will work with the System Operator for Northern Ireland (SONI) throughout the analytical process and will consult Northern Ireland Ministers at key points.
855. All licensed suppliers in Great Britain and Northern Ireland will be obliged to pay the supplier obligation. In general it is intended that the supplier obligation will be imposed equally on all UK suppliers in relation to their market share.
856. Northern Ireland Ministers intend to close the Northern Ireland Renewables Obligation in 2017. However, because of reforms to the Single Electricity Market in Northern Ireland, the Northern Ireland Executive does not plan to open its market to CfDs for projects commissioning before 2016 at the earliest, meaning a shorter transition period for Northern Ireland.

857. The Northern Ireland Department for Enterprise, Trade and Investment will have a consenting role in the transition in 2027 to the operation of a certificate purchase scheme (also known as a fixed ROC scheme) in Northern Ireland.
858. While the EPS is a wholly devolved matter to Northern Ireland, the EPS will be implemented on a UK-wide basis following consultation with the Department of Enterprise, Trade and Investment. There will also be an explicit duty on the Secretary of State to seek the consent of the Department of Enterprise, Trade and Investment when making regulations in respect of interpretation of the emissions limit duty and will require a Legislative Consent Motion to be passed by the Northern Ireland Assembly. The power to temporarily suspend the EPS, in the event that it is necessary to maintain security of supply, will fall solely to the Department of Enterprise, Trade and Investment to the extent that it applies to Northern Ireland.

Scotland

859. The generation and supply of energy are reserved matters under the Scotland Act 1998 and, therefore, all policies in EMR extend to Scotland.
860. We worked closely with the Scottish Government in finalising primary legislation and are working closely in framing further detail in secondary legislation, to deliver a coherent set of reforms and ensure a smooth transition to the new arrangements.
861. The Scottish Government will have a consultative role – set out in the Energy Bill – in the design and delivery of the CfD, as well as a consultative role within the accompanying institutional framework. Scottish Ministers have been consulted throughout the delivery plan process on the CfD aspects of the analysis and on the proposals relating to strike prices.
862. The UK Government will continue to involve Scottish Government officials in ongoing policy development at working level on other aspects of EMR such as the Capacity Market and FID Enabling for Renewables process.
863. Scottish Ministers have agreed to a statutory consultation role in the transition in 2027 to the operation of a certificate purchase scheme (also known as a fixed ROC scheme) in Scotland.
864. The EPS will be implemented on a UK-wide basis following consultation with Scottish Ministers. This consultation will take place before making regulations in respect of interpretation of the emissions limit duty and in the event that the EPS is temporarily suspended in the event it is necessary to maintain security of supply.
865. Scottish Ministers will also have a duty to implement an appropriate EPS enforcement regime for Scotland and will have the necessary regulation making powers.

Wales

866. All of the policies in EMR extend to Wales and energy policy is non-devolved in respect of Wales, though environment policy is broadly devolved.
867. We worked closely with the Welsh Government on primary legislation and are working on the detail of secondary legislation to deliver a coherent set of reforms and to ensure a smooth transition.
868. The Welsh Government has a consultative role – set out in statute – in the design and delivery of the CfD, as well as a consultative role within the accompanying institutional framework. Welsh Ministers have been consulted throughout the delivery plan process on the CfD aspects of the analysis and on the proposals relating to strike prices.
869. The Government will continue to involve Welsh Government officials in ongoing policy development at working level on other aspects of EMR such as the Capacity Market and FID Enabling for Renewables process.
870. The EPS will be implemented on a UK-wide basis following consultation with Welsh Ministers. This consultation will take place before making regulations in respect of interpretation of the emissions limit duty and in the event that the EPS is temporarily suspended in the event it is necessary to maintain security of supply.
871. Welsh Ministers will also have a duty to implement an appropriate EPS enforcement regime for Wales and will have the necessary regulation making powers. This includes determining the body that will be the “enforcing authority”, expected to be the new Natural Resources body for Wales.

Chapter 7: Next Steps

872. By the end of 2013, subject to Royal Assent to Energy Bill, the Government intends to publish the final EMR delivery plan with confirmed strike prices for CfDs for renewable technologies and the Capacity Market reliability standard. We expect to publish updated CfD contract terms as part of Renewables Investment Contracts at the same time and will also consider whether a further update of CfD contract terms is required to support the Parliamentary process in the first half of 2014.
873. We aim to publish the Government response to this consultation and to lay the final regulations in Parliament in late Spring 2014, and for the regulations to enter into force in July 2014, subject to the will of Parliament. Implementation of EMR is subject to State Aid approval, and we are working with the European Commission to secure this prior to the laying of regulations.
874. The first early CfDs could be signed in the form of investment contracts in early 2014, and the first CfDs under the enduring regime in the second half of 2014. We plan to run the first capacity auction in November 2014, for delivery in winter 2018/19. Implementation of EMR is subject to State Aid approval and we are working with the European Commission to secure this.

Stakeholder engagement during the consultation and timeline for response

875. Since the start of the EMR process the Government has engaged closely with a wide range of stakeholders. The EMR team has met regularly with relevant trade associations, energy companies, consumer groups, investors and NGOs to gather views and evidence on all aspects of EMR, as well as participating in key industry events.
876. Since May 2012, we have run three EMR Expert Groups on Contracts for Difference¹⁵⁸, the Capacity Market¹⁵⁹ and the Institutional Framework¹⁶⁰. In addition, to help ensure industry is ready for the introduction of the CfD and to work with stakeholders to ensure independent generators have a viable route to market, a CfD Market Readiness Steering Board, working groups on standard PPAs and code of practice, and an advisory group on the Offtaker of Last Resort proposal have been established.¹⁶¹

¹⁵⁸ <https://www.gov.uk/government/policy-advisory-groups/115>

¹⁵⁹ <https://www.gov.uk/government/policy-advisory-groups/114>

¹⁶⁰ <https://www.gov.uk/government/policy-advisory-groups/116>

¹⁶¹ <https://www.gov.uk/government/policy-advisory-groups/electricity-market-reform-emr-cfd-market-readiness-working-groups>

877. These groups are formed of senior representatives from a wide range of bodies within the electricity sector, including energy firms, National Grid, Ofgem and consumer groups. They enable individuals with expert knowledge to input on specific aspects of EMR policy design and provide an opportunity for DECC to keep industry stakeholders informed of EMR progress. Further information about the various EMR advisory groups can be found at the link below¹⁶².
878. This consultation closes on 24 December 2013. Detailed guidance on how to respond can be found within Chapter 1 of this document.
879. To assist stakeholders in preparing their responses, we propose a series of focussed workshops during the consultation period in addition to our ongoing engagements. These will provide opportunities for stakeholders to gain a greater understanding of the scope and contents of the consultation, and to enable DECC to directly capture feedback.
880. We plan to hold workshops in London and in Scotland, Wales and Northern Ireland which will cover key aspects of the consultation and be hosted jointly by the Devolved Administrations and UK Government.
881. Information on all our ongoing stakeholder engagement is available on the EMR stakeholder webpage¹⁶³. Information on how to request a place at the consultation workshops will shortly be made available on this site.

Operational systems implementation

882. For EMR to be implemented in a timely way and work end-to-end it is essential that:
- **All parties have clarity of their responsibilities** and those of others as part of an overall landscape
 - **All parties operate to a common timeline** and are ready at the right time
 - **All parties work to common standards** for communication, systems integration and participation
883. To help the Government, delivery partners and industry prepare for the implementation of EMR, the Government has commenced an intensive phase of collaborative development of EMR systems and processes. The purpose of this collaborative development is to ensure that all potential participants within the EMR schemes have a shared understanding of how EMR proposals could be implemented in practice and work at an operational level, and how

¹⁶² <https://www.gov.uk/government/policies/maintaining-uk-energy-security--2/supporting-pages/electricity-market-reform>

¹⁶³ <https://www.gov.uk/government/publications/engaging-with-decc-on-electricity-market-reform/engaging-with-decc-on-electricity-market-reform>

participants might be required to act within that process. This is a separate process from this consultation as it focuses exclusively on preparing for the systems implementation of EMR and is not a forum for discussing policy questions. Participants are also aware that systems are subject to change where scheme designs change as a result of passage of the Energy Bill through Parliament or as a result of responses to this consultation.

884. This collaboration consists of a series of open and transparent working groups with representation from all parties involved in ensuring system readiness, including DECC and its delivery partners, generators, suppliers and demand-side representatives. This process is overseen by an Implementation Steering Board (ISG) to ensure executive buy-in and enable companies to dedicate sufficient resources to the process. More background on the establishment of the ISG and papers for its meetings are available online.¹⁶⁴
885. Workshops on the Capacity Market began in August and on the CfD in early October. Working groups are open to all, with those who are not directly involved in implementation invited to attend as observers. The programme and input materials for these working groups have been published in advance of the sessions and can be found online.¹⁶⁵
886. The main inputs to the working group sessions have been draft process maps which set out the roles and responsibilities of each of the EMR participants. The Government intends that once the working groups are completed the process maps will be refined and used as a preliminary basis for creating a detailed Operational model and implementation plan for EMR to assist different types of participants in working out what they need to do when in order to take part, the scope of which is under development and being overseen by the Implementation Steering Group. It is our intention that both the implementation plan and Operational model will be published in draft by the end of 2013, after which they will be subject to changes to the Energy Bill or the detailed policy framework following this consultation. High level indicative implementation plans for both CfD and Capacity Market are set out below – these will be refined throughout the Collaborative Development process and updated versions will be placed on the Collaborative Development website.¹⁶⁶

¹⁶⁴ <https://www.gov.uk/government/policy-advisory-groups/electricity-market-reform-emr-collaborative-development>

¹⁶⁵ <https://www.gov.uk/government/policy-advisory-groups/electricity-market-reform-emr-collaborative-development>

¹⁶⁶ <https://www.gov.uk/government/policy-advisory-groups/electricity-market-reform-emr-collaborative-development>

Table 7.1: Indicative timeline for the implementation of Contracts for Difference

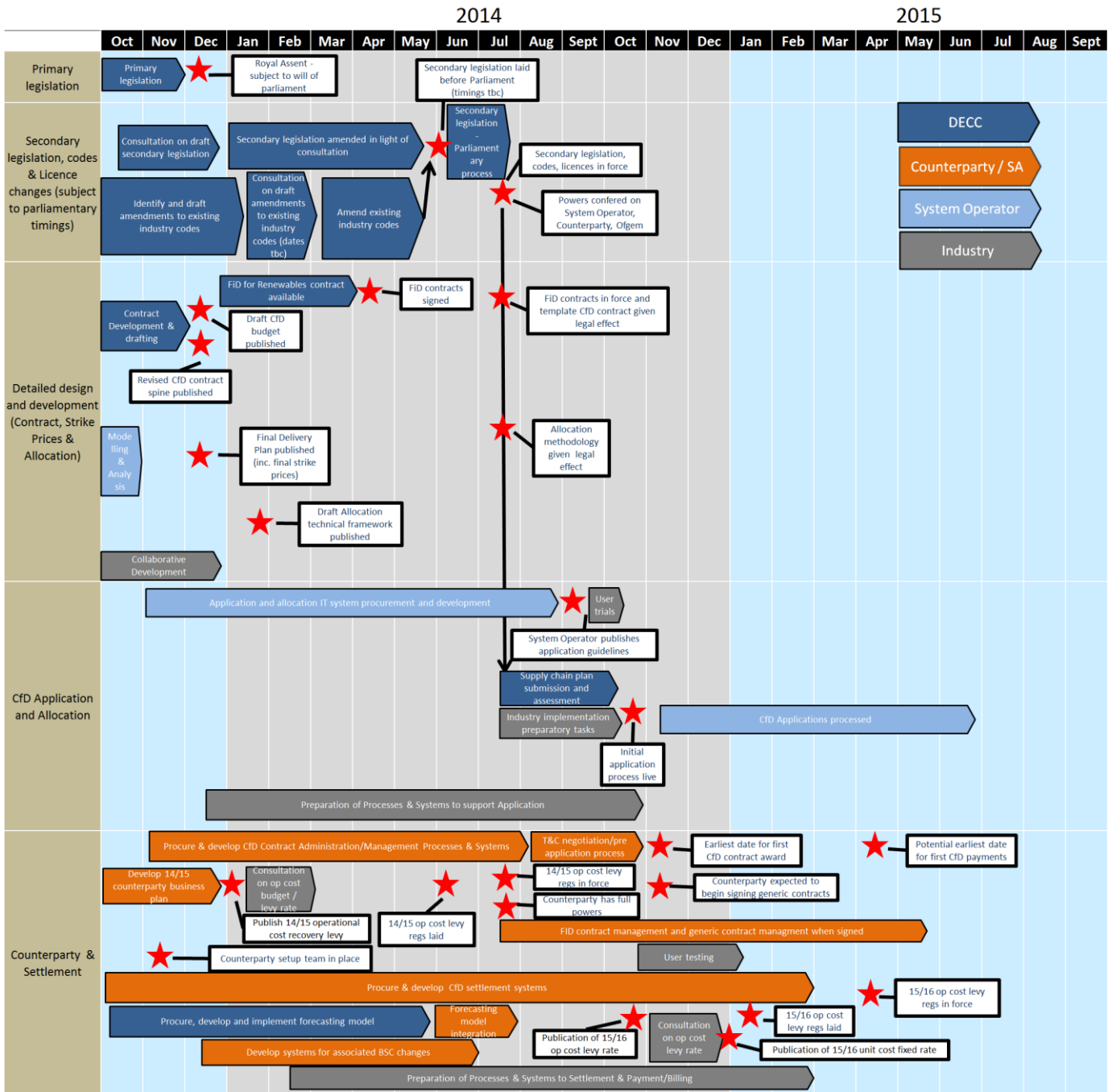

Glossary

AES	Annual Energy Statement
ATF	Allocation Technical Framework
BSC	Balancing and Settlement Code
BM	Balancing Mechanism
BMU	Balancing Mechanism Unit
BSCCo	Balancing Settlement code company
CCC	Committee on Climate Change
CCS	Carbon Capture and Storage (or Carbon Capture and Sequestration)
CDR	Customer Demand reduction
CCGT	Combined Cycle Gas Turbine (CCGT)
CEO	Chief Executive officer
CERT	Carbon Emissions Reduction Target
CfD	Contract for Difference
CHP	Combined Heat and Power
CHPQA	Combined Heat and Power Quality Assurance
CO ₂	Carbon Dioxide
CM	Capacity Market
CMRS	Central Meter registration Service
CMU	Capacity Market Unit
CPB	Counterparty Body
CPF	Carbon Price Floor
DAs	Devolved Administrations
DECC	Department of Energy and Climate Change
DETI	Department of Enterprise, Trade and Investment
DNOs	Distribution Network Operators
DSBR	Demand Side Balancing Reserve
DSR	Demand Side Response
EBSCR	Electricity Balancing Settlement code review
EC	European Council
EDR	Electricity Demand Reduction
EEC	European Executive committee
EIIs	Energy Intensive Industries
ELEXON	Settlement Agent
EON	Energy section operational notification
EMR	Electricity Market Reform
EPCs	Energy Performance Certificates
EPS	Emissions Performance Standard

EON	Energisation Operational notification
ESCROW	a contract, deed, bond, or other written agreement deposited with a third person, by whom it is to be delivered to the grantee or promisee on the fulfilment of some condition.
EU	European Union
EU ETS	European Union Emissions Trading Systems
FCFS	First Come first Served
FCP	Further Conditions Precedent
FID	Final Investment decisions
FID-e R	Final Investment Decisions enabling for Renewables
FiTs	Feed-in Tariffs
FMS	Fuel Measurement and Sampling
GB	Great Britain
GBS	Government Banking Service
GN	Guidance Note
GW	Gigawatt
HMT	HM Treasury
ITPR	Integrated Transmission Planning and Regulation
KW	Kilowatt
LOLE	Loss Of Load Expectation
LCF	Levy Control Framework
LSD	Long stop dates
MEL	Maximum Export Limit
MoU	Memorandum of Understanding
MW	Megawatt
MPAN	Meter point administration numbers
MWh	Megawatt-hour
NDA	Nuclear Decommissioning Authority
Net-CONE	Net Cost of New Entry
NG	National Grid
NGET	National Grid Electricity Transmission
NER-300	New entrants reserve 300
N.I.	Northern Ireland
Ofgem	Office of the Gas and Electricity Markets
OGD	Other Government Department
OCGT	Open cycle gas turbine
ORED	Office for Renewable Energy Deployment
PCG	Parent Company Guarantee
PPA	Power Purchase Agreement
PTE	Panel of Technical experts
QPO	Qualifying Power Output
RHI	Renewable Heat Incentive

RO	Renewables Obligation
ROC	Renewable Obligation Certificate
SBR	Supplemental Balancing Reserve
SEM	Single Electricity Market
SEMO	Single Electricity Market Operator
SF	Settlement Final
SFC	Substantial Financial commitment
SI	Statutory instrument
SID	Senior Independent Director
SO	Supplier Obligation; System Operator
SOLR	Supplier of Last resort
SONI	System Operator for Northern Ireland
SSSR	Statutory Security of Supply report
TEC	transmission export capacity
TCW	Target commissioning window
TO	Transmission Owner
TP	Termination provision
VoLL	Value of Lost Load
WHD	Warm House Discount

© Crown copyright 2013

Department of Energy & Climate Change
3 Whitehall Place
London SW1A 2HD
www.decc.gov.uk

URN 13D/218