

# using science to create a better place

Flow measurement structure design to  
aid fish migration without compromising  
flow data accuracy

Science Report: SC020053/SR2

The Environment Agency is the leading public body protecting and improving the environment in England and Wales.

It's our job to make sure that air, land and water are looked after by everyone in today's society, so that tomorrow's generations inherit a cleaner, healthier world.

Our work includes tackling flooding and pollution incidents, reducing industry's impacts on the environment, cleaning up rivers, coastal waters and contaminated land, and improving wildlife habitats.

This report is the result of research commissioned and funded by Environment Agency's Science Programme.

**Published by:**

Environment Agency, Rio House, Waterside Drive, Aztec W  
Almondsbury, Bristol, BS32 4UD  
Tel: 01454 624400 Fax: 01454 624409  
[www.environment-agency.gov.uk](http://www.environment-agency.gov.uk)

ISBN: 1844324893

© Environment Agency 2005

All rights reserved. This document may be reproduced with  
Prior permission of the Environment Agency.

The views expressed in this document are not necessarily  
those of the Environment Agency.

This report is printed on Cyclus Print, a 100% recycled stock  
which is 100% post consumer waste and is totally chlorine free.  
Water used is treated and in most cases returned to source  
in a better condition than removed.

Further copies of this report are available from:  
The Environment Agency's National Customer Contact Centre  
emailing [enquiries@environment-agency.gov.uk](mailto:enquiries@environment-agency.gov.uk) or by  
telephoning 08708 506506.

**Authors:**

Rodney White, Pam Bowker and Caroline McGahey

**Dissemination Status:** Publicly Available

**Statement of Use**

Please see page iv

**Keywords**

Calibration, design, fish biology, fish passage, flow  
measurement, hydrometry

**Research Contractor:**

HR Wallingford Ltd, Howbery Park, Wallingford  
Oxfordshire, OX10 8BA  
Tel: 01491 835381 Fax: 01491 825428  
<http://www.hrwallingford.co.uk>

**Environment Agency's Project Manager:**

Richard Iredale and Rachel Tapp, Olton Court,  
10 Warwick Road, Solihull B92 7HX

**Science Project Reference:** SC020053 (W6-084)

**Science Report:** SC020053/SR2

**Product Code:** SCH05005BJNX-E-P

# Science at the Environment Agency

Science underpins the work of the Environment Agency, by providing an up to date understanding of the world about us, and helping us to develop monitoring tools and techniques to manage our environment as efficiently as possible.

The work of the Science Group is a key ingredient in the partnership between research, policy and operations that enables the Agency to protect and restore our environment.

The Environment Agency's Science Group focuses on five main areas of activity:

- **Setting the agenda:** To identify the strategic science needs of the Agency to inform its advisory and regulatory roles.
- **Sponsoring science:** To fund people and projects in response to the needs identified by the agenda setting.
- **Managing science:** To ensure that each project we fund is fit for purpose and that it is executed according to international scientific standards.
- **Carrying out science:** To undertake the research itself, by those best placed to do it - either by in-house Agency scientists, or by contracting it out to universities, research institutes or consultancies.
- **Providing advice:** To ensure that the knowledge, tools and techniques generated by the science programme are taken up by relevant decision-makers, policy makers and operational staff.

Professor Mike Depledge      Head of Science

# Statement of use

This document provides information for Environment Agency Staff about consistent standards for flood defence and constitutes a Science output from the Water Resources Science Programme.

This Science Report gives the findings of Phase 2, which was divided into the following studies:

- desk study of the combined uncertainties associated with the introduction of fish-passage aids at Standard flow measurement structures;
- review of the problems of trash at fish passes and of ways to minimise accumulations;
- laboratory tests to provide an accurate hydrometric calibration of a Larinier fish pass;
- fundamental requirements for the near-crest arrangements of baffles on the downstream face of a measuring weir;
- laboratory testing of a Larinier fish pass with a submerged orifice upstream intake set alongside a flow measurement structure (non-specific).

# Acknowledgements

The Consultant wishes to thank the Environment Agency Project Manager and other members of the Environment Agency's Hydrometric and Fisheries Staff for their assistance with advice and provision of information and documentation used in the project. Thanks are also due to the members of the Environment Agency's staff and external advisors who took part in the interview process.

The review of trash problems at fish passes was carried out by Professor Robert Sellin, recently retired from the University of Bristol. His contribution is much appreciated.

# Notation

$b$  (m) = crest breadth measured at transverse section of upstream Larinier baffle

$C_{de}$  = dimensionless coefficient of discharge

$d_{ML}$  (m) = river depth at the modular limit

$h_1$  (m) = upstream gauged head relative to transverse section of upstream Larinier baffle

$g$  (m/s<sup>2</sup>) = acceleration due to gravity

$H$  (m) = upstream total head on Crump weir

$H_1$  (m) = upstream total head relative to transverse section of upstream Larinier baffle

$H_{1e}$  (m) = effective upstream total head relative to transverse section of upstream Larinier baffle

$H_{ML}$  (m) = upstream total head, at the modular limit, relative to transverse section of upstream Larinier baffle

$k_h$  (m) = head correction factor taking into account fluid property effects

$L$  (m) = distance to uppermost baffle on the downstream face of a triangular profile weir

$P$  (m) = height of transverse section of upstream baffle minus bed level at each gauge

$Q$  (m<sup>3</sup>/s) = flow

$Q_7$  (m<sup>3</sup>/s) = flow which is equalled or exceeded 7% of the time

$Q_{97}$  (m<sup>3</sup>/s) = flow which is equalled or exceeded 97% of the time

$Q_{ML}$  (m<sup>3</sup>/s) = flow at the modular limit

$T$  (m) = height of the uppermost baffle on the downstream face of a triangular profile weir

$v_1$  (m/s) = velocity of approach at gauge location

# Executive summary

## Introduction

This research project is concerned with the adaptation of standard hydrometric structures to aid the migration of fish and is intended to ensure that these adaptations do not significantly degrade the accuracy of the structure as a flow measurement device. The research provides specifications for fish migration adaptations that can be introduced without significantly affecting flow measurement performance.

### Overall Objective

To extend the scope of British Standards for flow measurement structures (currently the BS 3680 : Part 4 series) to include design features which would aid the migration of fish without significantly compromising flow measurement accuracy.

Specific objectives:

- To carry out laboratory testing of the highest priority proposals of phase 1 (as selected by the Project Board), building on the results of previous R&D work, and to refine design features such that fish passage is assisted without significantly affecting the accuracy of flow measurement.
- To quantify the impact of fish-passage aids on flow measurement accuracy and reliability.
- To produce a technical report that summarises the experiments, incorporates proposed amendments and additions to existing British Standards for gauging weirs or construction guidelines, and gives recommendations for future work.
- To promote the inclusion of these amendments and additions into British Standards through participation in the work of standards committees – an ongoing process, the timescale of which is dictated by the Standards organisations.

This Technical Report gives the findings of Phase 2, which was divided into five studies.

### **Study A Desk study of the combined uncertainties associated with the introduction of fish-passage aids at standard flow measurement structures (Chapter 2)**

The broad aims of this study were to look at three typical river situations and at four gauging structure–fish-pass configurations. In each case we sought to show (a) how flows through the devices and (b) uncertainties in gauged flow vary with river flow.

## **Key findings – flows (Appendix C)**

### *Computation of flows*

The method used to compute flows gives important information regarding individual flows through each section of a gauging structure and through the fish pass. This detailed analysis is essential to determine uncertainties.

### *Attraction flows for fish passes*

The method used to determine the number of fish-pass units required for any particular duty seeks to provide a flow through the fish pass that will attract fish towards the pass. However, this flow is only achieved when the maximum design head on the fish pass is reached. In most cases a significant percentage of the total flow passes over the gauging structure when this condition is reached. Detailed factors include:

- the relative heights of the fish pass and the gauging weir;
- the flow characteristics of both the gauging weir and the fish pass.

## **Key findings – uncertainties**

### *Uncertainty plots (Appendix D)*

The Environment Agency is interested in the uncertainty of the volume of water that passes a particular location over an extended period. The plots show uncertainties that, under certain conditions, are much higher than the acceptable uncertainty in volumes over extended periods.

### *Low heads*

All gauging structures yield high uncertainties at low heads, almost entirely because of the difficulties in measuring small values of head. This shows the need to develop highly accurate and stable instrumentation to measure head and also the need to maintain and check this instrumentation regularly.

### *Compound gauging structures*

Compound structures have the advantage that they can, by design, cover an extremely wide range of flows without undue raising of upstream (flood) levels. However, there is a discontinuity in the uncertainty curve when higher crests come into operation. The much higher overall uncertainties result from difficulties associated with estimating the head on the higher crest.

Having a second head measurement for the high crest and/or the fish pass could reduce uncertainties, but this incurs additional costs in maintaining the installation and in processing the data.

### *Drowning of the gauging structure*

Gauging structures that can be operated in the drowned flow range were developed to provide flow measurement with little afflux. However, operation of standard structures in the drowned flow range involves two measurements of head – one upstream and one downstream. As a general rule, uncertainties during the early stages of drowning are relatively modest, but increase as the extent of drowning increases.



### *Gauging structure–fish pass combinations*

Regardless of the flow measurement uncertainty associated with the fish pass itself, there is additional overall uncertainty because the head upstream of the fish pass is not normally measured directly. Hence, it is subject to the compound weir ‘transfer’ uncertainty.

### **Study B Review of the problems of trash at fish passes and ways to minimise accumulations (Chapter 3)**

In considering the impact of fish passage aids on flow measurement accuracy at weirs the matter of trash retention and accumulation is of primary importance for two reasons:

- retained trash very quickly makes a pass no longer passable for fish;
- retained trash may change the flow calibration for the weir (or weir–fish pass combination) as a gauging station.

This last point is of great significance where accurate low flow gauging is a high priority. Traditionally, local Environment Agency fishery officers have accepted that passes have to be inspected and trash cleared manually on a regular basis. This has serious implications as to Health and Safety for Environment Agency personnel. Any improvement in present arrangements to prevent trash accumulating would therefore increase the efficiency of passes, improve flow measurement accuracy and reduce maintenance costs to the Environment Agency.

### **Key findings**

- The literature search yielded very little useful information on methods to avoid trash problems.
- The strengths and weaknesses of anti-trash devices are given separately for screens, fixed deflectors and floating booms. While many factors apply to the different types, one common theme is the requirement for regular inspection and maintenance. This is both to ensure that the fish pass remains effective as far as fish migration is concerned and to maintain the head–discharge relationship if accurate flow measurement is to be achieved.

### **Study C Laboratory tests to provide an accurate hydrometric calibration of a Larinier fish pass (Chapter 4)**

The popularity of Larinier fish passes is increasing and their usage is likely to become widespread in the UK. Thus, there is a need to provide calibration data to hydrometric standards if they are to be considered for flow measurement alone or as part of a combined flow measurement system.

## Key findings

### *Modular flow calibration*

When a Larinier fish pass first spills, it does so over the transverse section of the most upstream baffle. As the flow increases, the 'herring bone' section of the upstream baffle is progressively over-topped until flow occurs over all sections of the upstream baffle (and similar flow conditions prevail at all the other baffles). At this stage the flow is highly three-dimensional. As the flow continues to increase, the flow pattern becomes progressively more two-dimensional (forward and vertical motions only) until the flow pattern settles to a quasi two-dimensional state in which the baffles could be regarded as bed roughness elements rather than 'weirs' in their own right.

These three phases result in a coefficient of discharge that varies with head. However, with this proviso, there is now data that enables the fish pass to be used as a flow measurement device with comparable accuracy to that of a conventional weir.

### *Modular limit*

The modular limit of the Larinier fish pass was evaluated using the same half-scale model as for the modular flow tests. The procedure was to set a particular discharge and to carry out tests with a series of increasing tailwater levels. These test series were carried out at three specific modular heads (flows) to evaluate any changes in the modular limit with flow.

### *Flow gauging adaptation at the head of a Larinier fish pass*

The Larinier fish pass has some shortcomings in terms of its use as a flow gauging structure, which could be overcome if a carefully designed gauging structure were to be placed upstream of the fish pass. However, hydraulic testing of this arrangement was considered important to look at flow patterns and to evaluate the implications of these in terms of the ability of fish to negotiate the fish pass and the gauging structure sequentially.

The important factors in terms of maintaining the ability of fish to migrate through the system have been established:

- The gauging structure must be set at a level not much higher than the head of the fish pass to minimise the magnitude of this additional 'hurdle' as far as fish are concerned.
- The gauging structure must be high enough to ensure that modular flow conditions, and hence gauging accuracy, are maintained up to a defined flow rate.
- The area between the fish pass and the gauging weir – the intermediate pool – must provide an area of relatively low velocity in which fish can rest before negotiating the gauging weir.

## **Study D Fundamental requirements for the near-crest arrangements of baffles on the downstream face of a measuring weir (Chapter 5)**

Research on 'Hurn'-type easements in the form of baffles on the downstream face of a triangular profile weir is ongoing, but the concept is judged to have promise because the baffle system can be fitted to existing weirs and the adaptation is relatively inexpensive.

One important design requirement is to know the minimum acceptable distance from the crest of the weir for the most upstream baffle. Fisheries interests would like this baffle as close as possible to the crest, to minimise velocities during the final stages of fish ascent. However, the hydrometric performance of triangular profile weirs is very sensitive to flow conditions close to the crest. A laboratory study was thus undertaken to establish the basic ground rules for the uppermost baffles in the Hurn-type easement arrangement in terms of size and distance from the crest.

### **Key findings**

- The results apply to Crump weirs and centre line conditions on flat-V weirs.
- The test conditions used in this investigation covered a range of baffle sizes and locations. All baffles had the shape of those currently in use at Hurn.
- The effects of near-crest baffles are dependent upon (i) the head over the weir up to which accurate modular flow performance is required, (ii) the distance from the crest line to the first baffle and (iii) the size (height) of the first baffle.
- A non-dimensional design chart has been derived to define those conditions that have little or no effect, taken as conditions that exhibit less than 1 per cent reduction from the basic Crump weir coefficient of discharge. It also provides an approximate means to determine the magnitude of the effect of any baffles that do not meet the 'no effect' criterion.

## **Study E Laboratory testing of a Larinier fish pass with a submerged orifice upstream intake set alongside a non-specific flow measurement structure (Chapter 6)**

One of the planned outputs from this research was to provide a first draft of a standard for combined fish pass–gauging structure installations. The general arrangement testing described in Chapter 6 was undertaken to confirm suitable design parameters to provide satisfactory gauging structure and fish-pass performance. In particular, the testing provided information on:

- flow conditions at the upstream entry to the fish pass;
- flow conditions at the downstream exit from the fish pass;
- flow conditions within the fish pass;
- flow conditions within the stilling basin of the measuring weir.

## **Key findings**

### *General*

In general the test facilities provided suitable hydrometric and fish migration conditions throughout the design flow range.

### *Flow conditions at the upstream entry to the fish pass*

The requirements for the upstream entry are that head losses should not significantly degrade flow measurement and that velocities should not be so high as to impede fish movement.

### *Flow conditions at the downstream exit from the fish pass*

The requirement for the downstream exit from the fish pass is that it should provide a definable jet of water to which migrating fish would be attracted. Preferably, this jet is to issue immediately downstream of the hydraulic jump formed on the downstream face of the gauging weir.

In all tests the hydraulic jump formed just upstream of the fish pass exit slot at low flows. Upstream migration of the hydraulic jump occurred as flows increased until drowning occurred.

### *Flow conditions within the fish pass*

The requirement for flows within the fish pass is that the hydraulic jump, if present, should not occur downstream of the most downstream baffle of the fish pass, thereby creating difficult access for migrating fish.

At low flows the tailwater level remains above the most downstream baffle of the fish pass, thereby providing suitable conditions for migrating fish. As flows increase, the hydraulic jump moves upstream until the onset of drowning, when sub-critical flow conditions occur throughout the fish pass.

### *Flow conditions within the stilling basin of the measuring weir*

To facilitate fish migration it is important that flow conditions in the stilling basin are sub-critical and that there is little instability in terms of large-scale eddies, which cause orientation problems for migrating fish.

In all tests a stable hydraulic jump was formed on the one in five downstream slope of the Crump weir. Flows that entered the stilling basin were sub-critical and free of large-scale eddies throughout the flow range for both series of tests.

## **Recommendations for further research (Chapter 7)**

Chapter 7 gives the detailed conclusions from this research project, which are summarised as key findings above. It also includes recommendations for further research designed to augment the research carried out to date, including the provision of software to aid implementation of the design methods developed.

*Software to evaluate flows through fish pass–gauging structure combinations*

The Environment Agency should commission software development to provide user-friendly software for use either in-house or by consultants working for the Environment Agency.

*Software to determine uncertainties in flow measurement at fish pass–gauging structure combinations*

The Environment Agency should commission software development to provide user-friendly software for use either in-house or by consultants working for the Environment Agency.

*Further research on the accumulation of trash at fish passes*

- Information on the trash behaviour at a wider selection of flow measurement structures could be obtained through a questionnaire designed with this purpose in mind, and sent to selected Environment Agency staff with responsibility for hydrometry.
- Research is needed into how best to establish upstream river conditions that would result in trash not passing close to fish pass entrances. The use of fixed bed vanes to impart the optimum secondary circulation in the river should be explored. The same approach could help where excessive bedload sediment is known to block passes.
- The effectiveness of floating booms in preventing trash ingress could be improved if more were known about the effect of boom length and location in relation to the inlet size and the position of the neighbouring weir crest, or other river flow structure. Laboratory tests might establish this.
- Guidelines for the design of screens should be drawn up, including the Health and Safety aspects of access for cleaning.

*Additional hydrometric calibrations of fish passes*

The current research has provided a 'hydrometric quality' calibration of a Larinier fish pass with 100 mm baffles. Further 'hydrometric quality' calibrations of alternative fish-pass types are required. To start this process it is suggested that a Larinier fish pass with 150 mm baffles should be tested. The aims would be two-fold:

- to provide details of the hydrometric performance of the 150 mm fish pass;
- to determine whether a general formulation can be provided for Larinier fish passes, which would provide much more flexibility in design.

This study requires volumetric flow measurement facilities with sufficient capacity to avoid unwanted scale effects, as used in Phase 1 of the Environment Agency research commission W6-084.

*Alternative arrangements of Hurn-type baffles*

Two further studies are suggested:

- a two-dimensional study in which different baffle shapes would be tested;
- a three-dimensional study to look at flow patterns when baffles are placed on the downstream face of flat-V weirs and to optimise and standardise the arrangement of the baffles.

These studies require volumetric flow measurement facilities with sufficient capacity to avoid unwanted scale effects, as used in Phase 1 of the Environment Agency research commission SC020053 (W6-084).

#### *Review of Fish Pass Guide*

For sections of the *Fish Pass Guide* by Armstrong *et al.* (2004) the introduction of the results of the current research would add value. We thus propose a review of the *Fish Pass Guide* with detailed suggestions for changes and additions.

#### *Field trials*

There is a need to verify that the findings of the current research can be implemented in the field. Members of the Project Board are actively reviewing plans for future capital works and are considering several specific sites. It is suggested that HR Wallingford should be a partner in this work, providing:

- technical inputs at Project Board level;
- computation of flows and uncertainties at the design stage;
- advice on hydrometric issues, as necessary;
- supervision of the evaluation of the hydraulic performance of the field installation.

#### *Additional Items*

In discussions with the Project Board many ideas have been generated for future research. In no particular order, these include:

- calibration data for pool and traverse fish passes;
- variable size 'Hurn'-type baffles;
- use of Larinier type units on the downstream face of gauging weirs;
- better design criteria for fish pass exits and entrances;
- consideration of the effects of wingwall over-topping.
- drowned flow data for fish passes.

# Contents

<b>Statement of use</b>	<b>iv</b>
<b>Acknowledgements</b>	<b>v</b>
<b>Notation</b>	<b>vi</b>
<b>Summary</b>	<b>vii</b>
<b>1. Introduction</b>	<b>1</b>
1.1 Objectives	1
1.2 Related research and guidance	1
1.3 Key issues	2
1.4 Project phases	3
<b>2. Desk study of the combined uncertainties associated with the introduction of fish passage aids at standard flow measurement structures (Study A)</b>	<b>5</b>
2.1 Introduction	5
2.2 Approach	5
2.3 Illustrative test case rivers	7
2.4 Hydrology	8
2.5 General summary of design criteria for gauging structures and fish passes	12
2.6 Design parameters for test weirs	13
2.7 Design parameters for fish pass	16
2.8 Simulation of flows through gauging structure / fish pass combinations	19
2.9 Uncertainties in flow measurement through gauging structure / fish pass complex	27
2.10 Summary of this investigation of uncertainties at weir / fish pass installations	33
<b>3. Review of trash accumulation and ways of minimising it at fish passes and fish passage aids (Study B)</b>	<b>35</b>
3.1 Background	35
3.2 Objectives	35
3.3 Methods employed	35
3.4 Data collection	36
3.5 Discussion of Data	37
3.6 Literature search	43
3.7 Factors influencing trash retention at fish passage aids	44
3.8 The choice and use of anti-trash devices at weirs	49
3.9 Summary of strengths and weaknesses of anti-trash devices	50
3.10 Proposals for further work	51
3.11 Conclusions	52
<b>4. Laboratory tests to provide an accurate hydrometric calibration of a Larinier fish pass (Study C)</b>	<b>57</b>
4.1 Introduction	57
4.2 Objectives	58
4.3 Laboratory installation	58
<b>Science Report SC020053/SR2</b>	<b>xv</b>
Phase 2	

4.4	The Larinier fish pass	58
4.5	Analysis of results	59
4.6	Flow gauging adaptation at the head of a Larinier fish pass	66
<b>5.</b>	<b>Fundamental requirements for the near-crest arrangements of baffles on the downstream face of a measuring weir (Study D)</b>	<b>73</b>
5.1	Introduction	73
5.2	Test arrangements	73
5.3	Testing	74
5.4	Results	75
5.5	Application of results	79
5.6	Conclusions	80
<b>6.</b>	<b>Laboratory testing of a Larinier fish pass with a submerged orifice upstream intake set alongside a non-specific flow measurement structure, (Study E)</b>	<b>81</b>
6.1	Objectives	81
6.2	Development of general arrangement to be tested	81
6.3	General arrangement modelling	82
6.4	Flow characteristics	84
6.5	Test results - Series A - Larinier fish pass at weir crest level	86
6.6	Test results - Series B - Larinier fish pass 0.18m below weir crest level	90
6.7	Conclusions	94
<b>7.</b>	<b>Conclusions and recommendations</b>	<b>96</b>
7.1	Introduction	96
7.2	Conclusions	96
7.3	Recommendations	106
<b>8.</b>	<b>References</b>	<b>110</b>

## Tables

Table 2.1	Characteristics of test case rivers	7
Table 2.2	Stage / discharge curves for test case rivers	8
Table 2.3	Values of $Q_{97}$ and $Q_7$ for test case rivers	12
Table 2.4	Operating range for Larinier fish passes	13
Table 2.5	Geometric parameters for test weirs	14
Table 2.6	Design parameters for test case weirs	15
Table 2.7	Number of fish pass units	18
Table 2.8	Summary of gauging structure / fish pass combinations	20
Table 2.9	Gauging structure / fish pass configurations	21
Table 2.10	Summary of flows for test cases	22
Table 2.11	Individual uncertainty values	28
Table 3.1	Location and classification of fish passes and easements examined (full reports in Appendix E)	38
Table 4.1	Raw coefficient data	61
Table 4.2	Critical dimensions of the fish pass / gauging structure arrangement	65
Table 4.3	Mean velocities in the pool	69



Table 4.4	Summary of velocities through the fish pass / gauging structure arrangement	71
Table 6.1	Series A tests parameters	86
Table 6.2	Series B tests parameters	90
<b>Figures</b>		
Figure 2.1	Stage / discharge curves for test case rivers	8
Figure 2.2	Relationship between 5% / 10% ADF and flow exceedance data for a range of UK rivers	10
Figure 2.3	Modular limits in terms of flow exceedance	11
Figure 2.4	Modular stage discharge curves for the test weirs	14
Figure 2.5	Approximate Larinier fish pass calibration	17
Figure 2.6	Percentage of total flow taken by the fish pass for all test cases	25
Figure 3.1	Examples of trash minimisation techniques used at fish pass entrances	54
Figure 3.2	Examples of types of trash deflector	55
Figure 4.1	Larinier fish pass	57
Figure 4.2	Larinier calibration ( $k_h = \text{zero}$ )	61
Figure 4.3	Flow data for the Larinier super-active fish pass with 100mm baffles	62
Figure 4.4	Modular limits for the Larinier fish pass	63
Figure 4.5	Larinier fish pass / Crump weir arrangement	68
Figure 4.6	Water surface profiles	69
Figure 4.7	Point velocities with a head on the Larinier fish pass of 0.4 m (nom.)	70
Figure 5.1	Testing arrangements for near-crest baffles	74
Figure 5.2	Experimental results - near-crest baffles	75
Figure 5.3	Crump weir showing separation pocket (modular flow)	76
Figure 5.4	Normalised results - near-crest baffles	77
Figure 5.5	Hydrometric effect of near-crest baffles	78
Figure 6.1	General arrangement - Larinier fish pass alongside a Crump weir	84
Figure 6.2	Larinier fish pass at weir crest level - Series A tests	85
Figure 6.3	Larinier fish pass 0.18m below weir crest level - Series B tests	85
Figure 6.4	Water surface profiles through the fish pass for the Series A tests	86
Figure 6.5	Head losses through the upstream entry to the fish pass for the Series A tests	87
Figure 6.6	Location of the hydraulic jump for the Series A tests	88
Figure 6.7	Water velocities at the entry to and the exit from the fish pass for the Series A tests	89
Figure 6.8	Water surface profiles through the fish pass for the Series B tests	91
Figure 6.9	Head losses through the upstream entry to the fish pass for the Series B tests	91
Figure 6.10	The effect of upstream orifice size on head losses based on the Series A and Series B results	92
Figure 6.11	Location of the hydraulic jump for the Series B tests	92
Figure 6.12	Water velocities at the entry to and the exit from the fish pass for the Series B tests	93

## **Appendices**

Appendix A Source of average flow and flow exceedance data for UK rivers

Appendix B Typical flow exceedance curves for rivers of 5m, 10m and 20m width

Appendix C Summary of flows through gauging structure /fish pass combinations

Appendix D Summary of combined gauging structure / fish pass uncertainties in flow

Appendix E Trash study - field records

Appendix F General Purpose Flume at HR Wallingford

Appendix G Larinier super-active fish pass with 100mm baffles

Appendix H Larinier flows - numerical values

Appendix I Hydrometric calibration of Larinier fish pass

Appendix J Velocities through fish pass / gauging structure arrangement

Appendix K Flow conditions, fish pass / gauging structure arrangement

Appendix L Fish pass/gauging structure arrangement testing

Appendix M Draft Standard - Fish passes at flow gauging structures

# 1. Introduction

The aim of this research project is to adapt standard hydrometric structures to aid the migration of fish and to ensure that these adaptations do not significantly degrade the accuracy of the structure as a flow measurement device. It is not concerned with the hydraulic performance of basic flow measurement structures, which are to be found in British and International Standards. The research will provide specifications for fish migration adaptations that can be introduced without significantly affecting flow measurement performance.

## 1.1 Objectives

The Environment Agency terms of reference give the following project objectives:

### **Overall objective**

To extend the scope of British Standards for flow measurement structures (currently the BS 3680:Part 4 series, 1986) to include design features that would aid the migration of fish without significantly compromising flow measurement accuracy.

- to research and consult, review and report on the *range* of possibilities that exist for the adaptation of measurement structures to aid the migration of fish, covering a range of weir types and potential baffle, composite pass or bypass options;
- to prioritise the hydraulic investigation of the above and to recommend a costed programme of laboratory work that best serves the Environment Agency's immediate needs for new and/or revised design standards for new and reconstructed gauging structures to aid the passage of fish.
- to carry out laboratory testing of the highest priority proposals, building on the results of previous research and development (R&D) work, and to refine design features such that fish passage is assisted without significantly affecting the accuracy of flow measurement;
- to quantify the impact of fish passage aids on flow measurement accuracy and reliability;
- to produce a technical report that summarises the experiments, incorporates proposed amendments and additions to existing British Standards for gauging weirs or construction guidelines and gives recommendations for future work;
- to promote the inclusion of these amendments and additions into British Standards through participation in the work of Standards committees – an ongoing process, the timescale of which is dictated by the Standards organisations.

## 1.2 Related research and guidance

This research project relates to the following ongoing and recently completed Environment Agency research projects and guidance:

- Child *et al.* (2002) *Review of good practices for hydrometry*. Environment Agency Draft Technical Report W6(00)07.
- Clough and Turnpenny (2001) *Swimming speeds in fish: Phase 1*. Environment Agency Technical Report W2026/TR1.
- Joint National Hydrometry and Fish Pass Group (2001) *Guidance on the design and construction of Crump and Flat-V gauging weirs in relation to fish passage*. Environment Agency memo.
- National Rivers Authority (1995) *Hurn weir gauging station: re-appraisal of options to facilitate the upstream migration of Dace*. National Rivers Authority, Project No. C5200.
- Phillips and Clarke (2001) *Weirs, flow measurement and fish passage: action on reconciling the conflicts*. Environment Agency memo.
- Turnpenny *et al.* (2001) *Literature review of swimming speeds of freshwater fish*. Environment Agency R&D Technical Report W2-026/TR1.
- Turnpenny *et al.* (2002a) *Fish passage at flow gauging stations in England and Wales. Stage 1: Literature review and regional survey*. Environment Agency R&D Technical Report W6-029/TR1.
- Turnpenny *et al.* (2002b) *Fish passage at flow gauging stations in England and Wales. Stage 2: Fish pass physical model evaluation and field studies*. Environment Agency R&D Technical Report W6-029/TR2.
- Walters (1996a) *Hydraulic model tests on the proposed fish pass structure for Hurn gauging weir, Dorset*. Exeter Enterprises Ltd.
- Walters (1996b)- *Hydraulic model tests on the proposed fish pass structure for Hurn gauging weir, Dorset: supplementary report*. Exeter Enterprises Ltd.
- Walters (1997) *Hydraulic model tests on the proposed fish pass structure for Hurn gauging weir, Dorset: supplementary report no. 2*. Exeter Enterprises Ltd.

### 1.3 Key issues

In its proposal, HR Wallingford identified three key issues important to securing a successful outcome from the project:

#### **Communication and understanding**

There is an understandable difference between the aspirations and requirements of hydrometric and fisheries interests. To function, flow gauging structures require a water level difference between the upstream and downstream reaches. This water level difference induces the potential for high adverse velocities as far as the passage of fish is concerned. It is important, therefore, that both parties understand each other's problems.

#### **Accuracy requirements for flow measurement**

The accuracy requirements for flow measurement vary with the usage of the data. Generally speaking, low and medium flows require high accuracy because of the requirement to monitor and share water in situations where supply is limited. Flood flows need less precision.

Standard specifications for gauging structures generally quote the accuracy of the coefficient of discharge, but this is not the accuracy of the measured flow.

The location, quality and maintenance of the structure, the zeroing of the water level gauge and the accuracy of the water level recording apparatus also influence the accuracy of the measured flow. Coefficients of discharge need to be measured and quoted in standards to an accuracy of between 1 and 3 per cent so that the user may achieve measured flows to an accuracy of between 5 and 10 per cent.

Under these circumstances it is necessary to agree what, if any, deviation from the standard coefficient of discharge is permissible when introducing fish adaptations. The Environment Agency wishes to have the results promoted through British and International Standards, and in doing this it must be realised that the Environment Agency's requirements regarding the accuracy of flow measurement are not the only ones to be considered.

### **Fish performance and requirements**

The swimming performance of fish depends on many factors, including:

- species
- individual size and ability
- water temperature
- water depth
- water velocity
- water quality
- turbulence
- motivation.

It is thus a complex subject with many variations. The data available are variable in both quantity and quality, and complex to interpret. Hence it is necessary to reach an agreed consensus on the hydraulic parameters that are acceptable from a fisheries point of view before Phase 2 of this project, which involves large-scale testing of the most promising devices.

## **1.4 Project phases**

The Technical Report on Phase 1 of this research project gives the results of a literature review of readily available information. It also contains the results of a questionnaire, a workshop and some follow-up interviews with interested parties. Prioritised and costed laboratory proposals were developed in Phase 1 and recommendations for Phase 2 were given in White and Woods-Ballard (2003).

This Technical Report gives the findings of Phase 2, which comprises the highest priority projects proposed under Phase 1 selected by the Project Board. Phase 2 was divided into the following studies:

Study A Desk study of the combined uncertainties associated with the introduction of fish passage aids at Standard flow measurement structures

- Study B A review of the problems of trash at fish passes and ways of minimising accumulations
- Study C Laboratory tests to provide an accurate hydrometric calibration of a Larinier fish pass
- Study D Fundamental requirements for the near-crest arrangements of baffles on the downstream face of a measuring weir
- Study E Laboratory testing of a Larinier fish pass with a submerged orifice upstream intake set alongside a flow measurement structure (non-specific)

A separate chapter in this report deals with each of these five studies.

A final chapter deals with the overall conclusions, recommendations on how to apply the project findings, and recommendations for further work.

## 2. Desk study of the combined uncertainties associated with the introduction of fish passage aids at standard flow measurement structures (study A)

### 2.1 Introduction

When a fish pass is placed alongside a flow gauging structure the river flow is divided between the two. If the upstream invert (notches) or crest (baffles) of the fish pass is set at the same level as the lowest crest elevation of the gauging structure both devices spill at the same time. If the upstream invert or crest of the fish pass is set at a lower level than the lowest crest elevation of the gauging structure, the latter takes no flow until the head over the fish pass exceeds the elevation difference between the devices. In both cases the proportion of the total river flow that passes over each device usually varies with river flow.

The broad aims of this study are to look at three typical river situations and at four gauging structure–fish pass configurations. In each case we have sought to show how (a) flows through the devices and (b) uncertainties in gauged flow vary with river flow. The aims are thus achieved by looking at typical test cases. To that extent this is a demonstration study. It relies heavily on the design assumptions made and the nature of the test case rivers chosen. The Project Board has given valuable assistance in choosing the size and nature of the rivers, the gauging structures and the fish passes.

### 2.2 Approach

The approach was discussed and agreed with the Project Board. It comprised the following components, which are discussed in more detail in the subsequent sections of this report:

- consider typical hydraulic and hydrological natural physical characteristics of three test-case rivers that cover bed widths of between 5 m and 20 m;
- consider Crump (5 m), flat-V (5 m and 10 m) and compound Crump (20 m) weirs;
- determine a consistent design procedure for gauging structures (i.e., their sizing and elevation relative to consistent modular or non-modular flow criteria);
- determine consistent design procedure for fish passes (Larinier type in all cases) – i.e., width of pass and relative elevation of flow inlet to weir crest – to meet consistent flow attraction criteria;
- design gauging structure–fish pass systems;

- identify simple but reasonably accurate flow calibration for Larinier fish passes;
- compute flow distributions between the fish pass and the weir(s);
- compute combined uncertainties in flow measurement.



## 2.3 Illustrative test case rivers

Rivers with bed widths 5 m, 10 m and 20 m were chosen, based on Environment Agency experience and current practice, as covering typical situations in which the use of flow gauging structures would be appropriate.

### River characteristics and slopes

The cross-sectional shape and slope of these rivers were derived from regime concepts (Ackers and White, 1973; White *et al.*, 1982). Regime concepts were originally developed in India, where unlined canals are used to distribute water to irrigated areas. It was noted that these canals developed a natural cross-sectional size and shape dependent upon the amount of water and sediment they carried, together with the nature (mainly size) of the sediment. It was also noted that these canals tended to develop meanders if the longitudinal slope of the canal did not match the 'regime slope', which is again dependent upon water and sediment quantities plus sediment size.

More recently, research has identified the processes that are important in the development of natural channels, and quantitative methods are now available to predict the size, shape and slope of natural channels. Generally, channel shape is approximated to a trapezium, but methods are being developed to allow further sophistication. The basic methods have been incorporated in suitable software packages. For this study, HR Wallingford's SHARC–DORC software was used to perform the calculations. In each case a sand size of 0.3 mm was assumed for the bed material, along with a sediment concentration of 100 ppm. Water temperature was assumed to be 15°C. All these values are typical of the 'middle' reaches of UK rivers. The computed river slopes were 0.00038, 0.00029 and 0.00021 for nominal widths of 5 m, 10 m and 20 m, respectively.

The full set of results is given in *Table 2.1*.

**Table 2.1 Characteristics of test-case rivers**

<i>Parameter</i>	<i>River widths (m)</i>		
	<b>5</b>	<b>10</b>	<b>20</b>
Bank full capacity (m <sup>3</sup> /s)	2.85	9.66	46.24
Width (m)	5.00	10.36	20.00
Depth (m)	0.82	1.30	2.54
Mean velocity (m/s)	0.63	0.70	0.85
Longitudinal bedslope ( $\times 10^{-3}$ )	0.383	0.287	0.210
Side slope (1v:SSh)	0.65	0.88	1.30
Manning 'n' at bank full	0.023	0.026	0.028

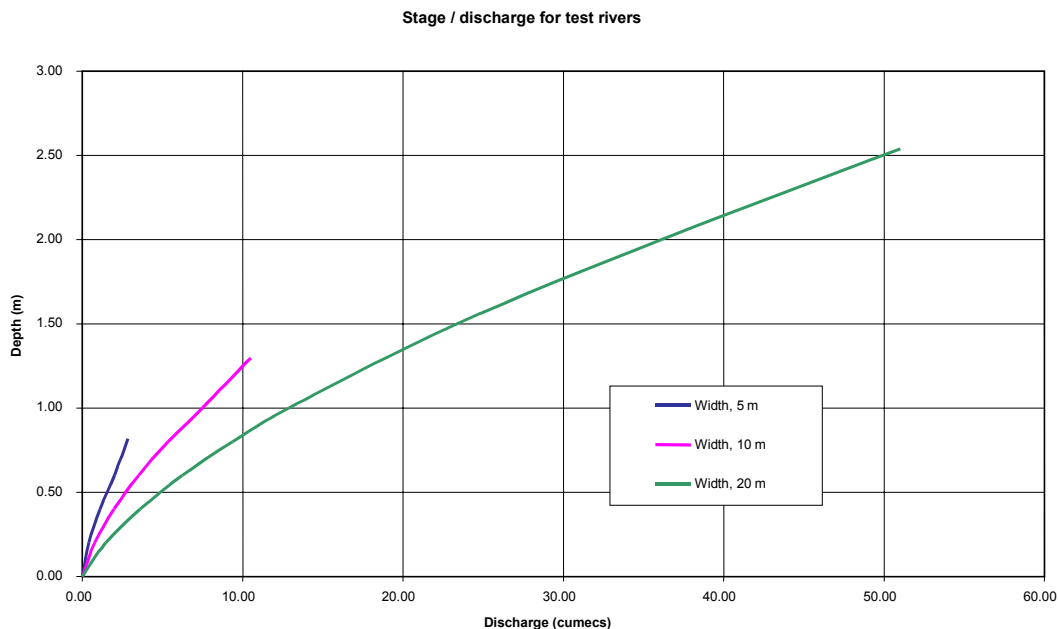
### Stage discharge curves

Stage discharge curves were derived using the method, proposed by White *et al.* (1980) and White *et al.* (1987), in which the alluvial friction varies as bed features develop. Again, HR Wallingford's SHARC–DORC software was used to perform the calculations. The results are given in *Table 2.2* and plotted, up to bank full level, in *Figure 2.1*. There are minor discrepancies between the results

shown in *Tables 2.1* and *2.2* because of certain simplifications made in the calculations.

**Table 2.2 Stage discharge curves for test-case rivers**

Stage (m)	Bank full river width (m)		
	5	10	20
Discharge (m <sup>3</sup> /s)			
0.2	0.42	0.77	1.46
0.4	1.10	1.97	3.60
0.6	2.01	3.50	6.25
0.8	3.14	5.33	9.36
1.0		7.44	12.88
1.5		13.90	23.35
2.0			36.09
2.5			50.97



**Figure 2.1 Stage discharge curves for test-case rivers**

The analytical approach to regime channels is complex and it is not possible to give general simple rules that describe the inter-relationship between the large number of variables. However, to pursue this subject further see White *et al.* (1981).

## 2.4 Hydrology

The hydrometric design of gauging structures and the design of fish passes were discussed with the Project Board, thus gaining the practical experience of members. Information from the literature was also used. It became apparent that design criteria for gauging structures and for fish passes sometimes used flow duration data and sometimes average flow data (or a percentage thereof).

For example, gauging structures are often designed to ensure that they operate in the modular flow condition up to certain flow percentiles or a certain multiple of the dry weather flow. 'Attraction flows' to fish passes are often stipulated in terms of a (low) percentage of the average daily flow.

To be consistent between all the test cases the use of parameters based on flow duration data only was preferred. Thus, the relationship between flow duration data and average flow data was explored to identify typical correlations. In particular, it was important from a fisheries point of view to establish a reasonable relationship between the two in the flow range between 5 and 10 per cent of average daily flow, the range recommended by the Environment Agency Project Board for fish pass attraction flows.

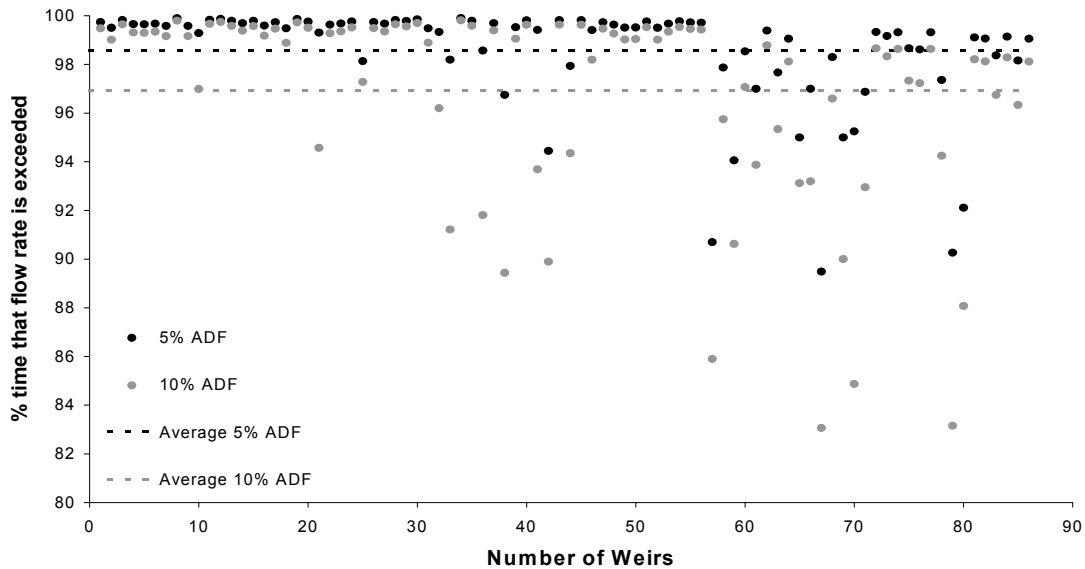
*Note 1.* The Environment Agency recommendations for fish pass flows adequate to attract fish towards the fish pass differ from those given by Larinier *et al.* (2002). The latter give the following:

- 1-5 per cent of the competing flow (taken to mean the river flow that does not pass through the fish pass);
- 10 per cent of the minimum flow for fish pass on large rivers;
- 1-1.5 per cent of the highest design flows – generally around twice the average daily flow.

*Note 2.* Water Resources weirs in the Midlands Region of the Environment Agency are designed to remain modular to at least five times the dry weather flow – typically the 91 percentile on the flow duration curve.

#### **2.4.1 Illustrative relationships between flow duration characteristics and average flows**

Data from the Anglian (from the UK Hydrometric Register) and Midlands (supplied by the Environment Agency) Regions were assessed to investigate the relationship between the percentile flow exceedance and 5 and 10 per cent of the ADF. *Figure 2.2* provides the percentile values for the 86 weirs considered, and shows average percentile values of 98.6 and 96.9 for 5 and 10 per cent ADF, respectively.



**Figure 2.2 Relationship between 5 and 10 per cent ADF and flow exceedance data for a range of UK rivers**

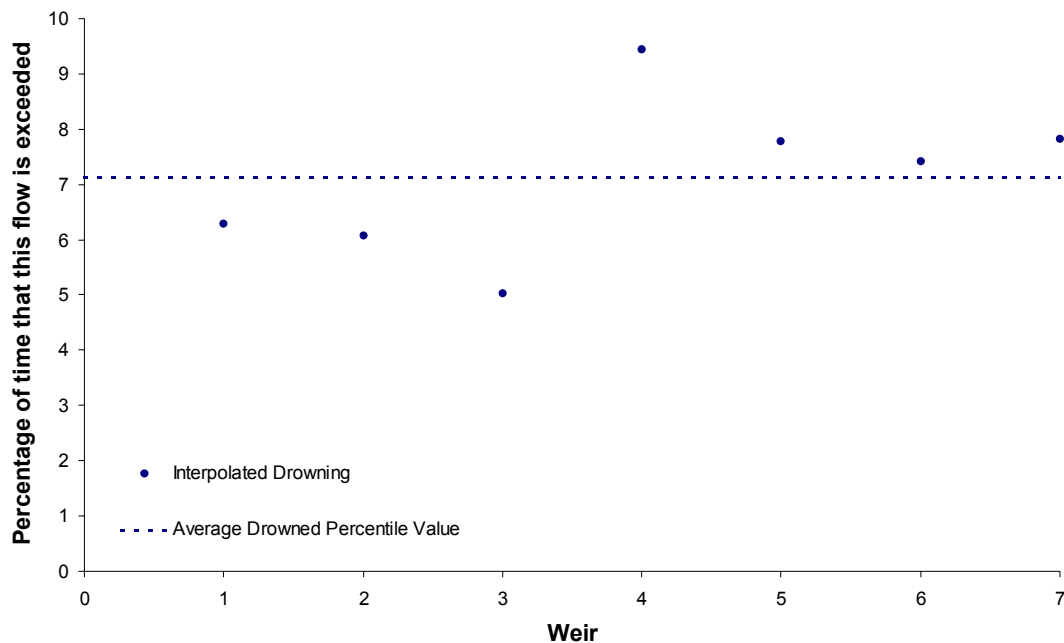
The source of the data used in this analysis is given in Appendix A.

Additional hydrological and hydrometric data were supplied by the North East Region of the Environment Agency, but too late to be included in the analysis. The source data are, however, included in Appendix A for completeness.

#### **2.4.2 Illustrative relationships between flow duration characteristics and design modular limits for gauging structures**

In designing gauging structures one important decision that has to be made is the crest height. A high elevation ensures that the weir remains modular over a wide range of flows and reaps the benefit of the high accuracy associated with the modular operation. A low elevation promotes drowning at an early stage and the modular accuracy can be lost over a significant proportion of the flow range. It was agreed that the crest heights for the test cases would be chosen such that each weir reached its modular limit at the same point on the flow duration curve. An exercise was undertaken to establish the appropriate point based on experience with existing gauging structures.

The data (from the UK Hydrometric Register) are scarce, as generally the drowning flow conditions are described but flow rates at the modular limit are not provided. The results for all Environment Agency regional sites with available data are shown in *Figure 2.3*. The average percentile is given as 7.1 (i.e.,  $Q_7$  corresponds to the modular limit – the onset of drowning).



**Figure 2.3 Modular limits in terms of flow exceedance**

The scarcity of information on design modular limits is unfortunate. The rational design of standard flow gauging structures demands this particular piece of knowledge. Perhaps this information is scattered in design offices and has not been published in the generally available literature.

#### **2.4.3 Flow duration criteria for the weir and fish pass design for the test-case rivers**

It is necessary in this study to make realistic assumptions regarding the flow duration criteria for the test-case rivers. This is because:

- The crest of the gauging structure is to be set to provide a realistic range of modular operation before the onset of drowning. This range is to be related to a particular flow exceedance value (see Section 2.6).
- The size of the fish pass, in terms of the numbers of standard Larinier units incorporated in the pass, is to be chosen such that the fish pass has a flow of between 5 and 10 per cent of the ADF. This flow range, in turn, is to be related approximately to a particular flow exceedance value – (see Section 2.7).

The data used in Sections 2.4.1 and 2.4.2 (see Appendix A) were sorted into ranges of river widths and plots of percentage flow exceedance against flow were produced for nominal river widths of 5 m, 10 m and 20 m. As expected, there was significant scatter in the results because of the differing characteristics of the rivers and their catchment hydrology. The plots are shown in Appendix B.

The important values of flow exceedance, as identified in Sections 2.4.1 and 2.4.2, are:

- $Q_{97}$  for the attraction flow to the fish pass;
- $Q_7$  for the modular limit of the gauging structure.

For this study the realistic values given in *Table 2.3* have been assumed. These are based loosely on the data presented in Appendix B. The initial values were judged by eye and then refined to give consistent trends with changing river width. Finally, a check was made on the ratio  $Q_{97}/Q_7$  to ensure that this ratio diminished consistently with increasing river width. Further refinement was considered of value.

**Table 2.3 Values of  $Q_{97}$  and  $Q_7$  for test-case rivers**

<i>River width (m)</i>	$Q_{97} (m^3/s)$	$Q_7 (m^3/s)$	$Q_{97}/Q_7$
5	0.3	1.5	0.20
10	0.6	4.5	0.13
20	3.0	30.0	0.10

## 2.5 General summary of design criteria for gauging structures and fish passes

### 2.5.1 Gauging structures

#### **Modular range of gauging structures**

For the purpose of this study we have assumed that a flow that exceeds 7 per cent of the time,  $Q_7$ , is a satisfactory design flow for the modular limit of a gauging structure.

### 2.5.2 Fish passes

#### **Attraction flows**

For the purpose of this study it seems reasonable to assume that a flow that exceeds 97 per cent of the time,  $Q_{97}$ , is a satisfactory design flow for a fish pass. This will, in most cases, be within the range 5-10 per cent of ADF.

#### **Dimensions and operating range**

Design criteria for the satisfactory hydraulic performance of Larinier fish passes were taken from Vigneux and Larinier (2002), augmented by discussions with the Project Board. These data are given in *Table 2.4*.

**Table 2.4 Operating range for Larinier fish passes**

<i>Fish species</i>	<i>Baffle height (m)</i>	<i>Operating flows (cumecs / m)</i>	<i>Operating upstream heads (m)</i>	<i>Upstream head range (m)</i>
Salmonids	0.15	0.25-1.40	0.23-0.82	0.59
Smaller fish	0.10	0.15-0.50 (0.83, see Section 2.5.2]	0.18-0.42 (0.6, see Section 2.5.2)	0.24 (0.42, see Section 2.5.2)

This present research took the calibration of the Larinier fish pass with 100 mm baffles to a head of 0.6 m (see Chapter 4). After observing flow conditions at this head the Project Board were happy to extend the working range of the fish pass to this new upper limit.

## 2.6 Design parameters for test weirs

In each test case the crest height of the gauging structure was determined such that the structure would reach its modular limit at  $Q_7$  on the flow duration curve. Operation in the drowned flow range was, therefore, restricted to 7 per cent of the time.

The procedure adopted was to compute the approximate modular flow stage–discharge relationship for each weir, assuming deep approach conditions. These curves were then compared with the natural stage–discharge curves for the test rivers and the elevation of the crest was chosen to ensure that the modular limit occurred at  $Q_7$ .

Details of the procedure are given below.

### 2.6.1 Modular stage–discharge curves for the test weirs

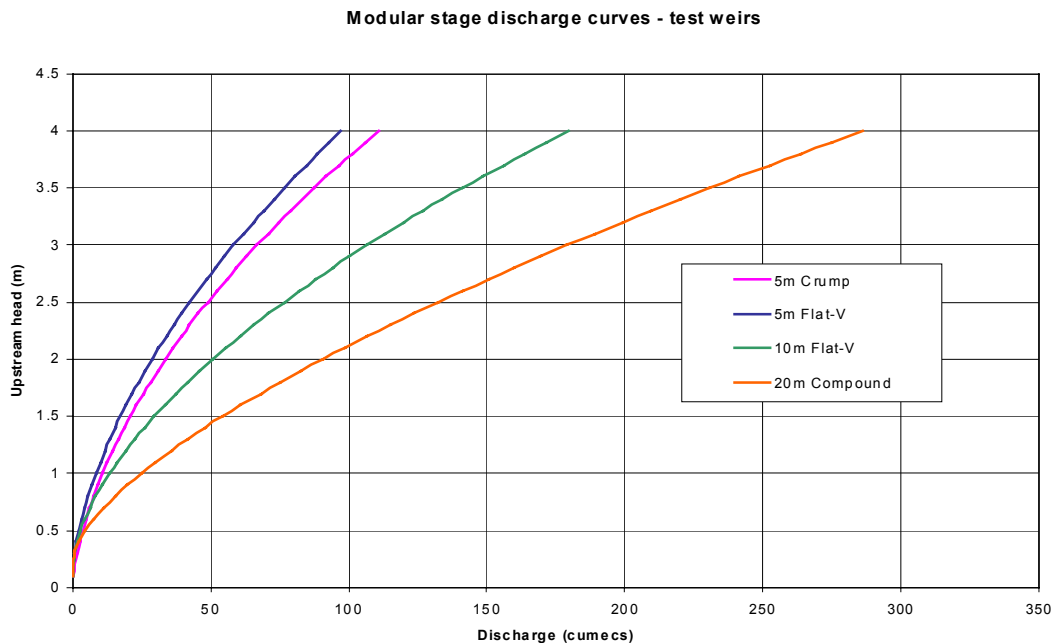
HR Wallingford’s in-house software was used to determine close approximations to the stage–discharge relationships for four gauging structures, two for the 5 m wide test-case river and one each for the 10 m and 20 m wide rivers. These close approximations are required to determine the crest height of the weir, which will remain modular up to a prescribed flow. Only when the crest elevation has finally been set can the precise stage–discharge curve be computed. To achieve the close approximations the weir heights were set to an arbitrary 1 m and an arbitrary river bed datum of 100 m was chosen. This is adequate to determine crest elevation, which will ensure modular flow conditions up to a defined river flow. Once the crest elevation is determined the detailed calculations of the flow distributions through the weir–fish pass combinations use actual weir heights (see Section 2.8). Details are given in *Table 2.5*.

**Table 2.5 Geometric parameters for test weirs**

Parameter	Simple Crump	Flat-V		Compound Crump	
				Low crest	High crest
River width (m)	5	5	10	20	
No. of parts	1	1	1	2	
Crest width (m)	5	5	10	2	18 (2 x 9)
Crest level (mAD)	101.0	101.0	101.0	101.0	101.3
Cross-slope	-	10	10	-	-
Flank slope	0	0	0	0	
U/S bed level (mAD)	100	100	100	100	
U/S width (m)	5	5	10	20	
D/S bed level (mAD)	100	100	100	100	
D/S width (m)	5	5	10	20	
D/S bank slope	0	0	0	0	
Flow type	Modular	modular	modular	modular	
Calculation type	Calibration	calibration	calibration	calibration	
Range (m)	0-4	0-4	0-4	0-4	
Calibration interval (m)	0.01	0.01	0.01	0.01	

Note. The computational methods for compound weirs do not need to take into account the location of particular crest sections across the width of the weir.

The resulting modular stage–discharge curves are shown in *Figure 2.4*.



**Figure 2.4 Modular stage–discharge curves for the test weirs**



## 2.6.2 Crest elevations of the test weirs to satisfy the modular limit criterion

The procedure to determine crest elevations of the test-case weirs is described below and the results are summarised in *Table 2.6*. Steps in the procedure were:

1. Read off the flow in the test-case rivers at the modular limit conditions (i.e.,  $Q_{ML} = Q_7$ ) using *Figures B1, B2 and B3* (Appendix B, summarised in *Table 2.3*).
2. Read off the natural depth of flow at the modular limit,  $d_{ML}$ , in the test-case rivers, from *Figure 2.1*. (This remains the depth in the river downstream of the gauging structure and hence determines the tailwater conditions at the modular limit.)
3. Read off the upstream modular head for the appropriate gauging structures,  $H_{ML}$ , using a flow value of  $Q_7$  in *Figure 2.4*.
4. Calculate the corresponding downstream head at the modular limit as  $0.75 \times H_{ML}$ .
5. Calculate the crest level required as  $d_{ML} - (0.75 \times H_{ML})$ .

The above calculations all assume that total heads equal gauged heads, which is adequate for design purposes. However, when detailed stage discharge curves are produced for the gauging structure–fish pass combinations, the differences between total and gauged heads are fully taken into account (see Section 2.8). The situation also becomes more complex when the fish pass is placed alongside the gauging structure and attracts a proportion of the river flow.

*Note.* The flat-V weir standard quotes the modular limit as 65–75 per cent. For ease of calculation we have assumed that both the Crump weir and the flat-V weir have a modular limit of 75 per cent.

**Table 2.6 Design parameters for test-case weirs**

Test case	Modular limit conditions				Crest elevation above bed (m) $d_{ML} - 0.75 \times H_{ML}$
	Flow ( $m^3/s$ ) $Q_7 = Q_{ML}$	D/S river depth (m) $d_{ML}$	U/S head (m) $H_{ML}$	D/S head (m) $0.75 \times H_{ML}$	
5 m Crump	1.5	0.49	0.28	0.21	0.28
5 m flat-V	1.5	0.49	0.41	0.31	0.18
10 m flat-V	4.5	0.71	0.61	0.46	0.25
20 m compound	30.0	1.76	1.10	0.83	0.93

## 2.7 Design parameters for fish pass

### 2.7.1 Historic calibration data for Larinier fish passes

Chapter 4 describes experimental work to provide a detailed hydrometric calibration of a Larinier fish pass (see *Figure 4.1*). Such precision is not required for this general assessment of flows and uncertainties at gauging structure–fish pass combinations. Instead, published information on the calibration of Larinier fish passes was used and adapted to a suitable format for inclusion in our analysis of combined flows and uncertainties.

Calibrations are available in Vigneux and Larinier (2002) and Turnpenny *et al.* (2002b). Unfortunately, the former authors present graphic calibration data, and equations for direct computational methods are not given. Unfortunately also, the latter provide equations, but with heads are related to channel invert, not crest level. These equations have no physical meaning and include a dimensional coefficient with very awkward units. They should be used with great care.

For this study it was desirable to produce a ‘weir equivalent’ to the Larinier fish pass for calibration purposes. This would enable us to analyse flows through the gauging structure–fish pass combination using existing software. In effect, the fish pass would be one section of a compound weir. To this end the Vigneux and Larinier (2002) curves and the tabled experimental data given by Turnpenny *et al.* (2002b) gave two series of points on the head–discharge curve, which were plotted (*Figure 2.5*). These data are mutually compatible.

The baffles of a Larinier fish pass are similar to thin-plate weirs, but with complications associated with the variable crest level, the chevron formation and the rounding of the crest. However, a thin-plate weir calibration was derived assuming that the crest breadth was equal to the width of the Larinier fish pass, that the crest level was at the level of the transverse section of the baffle and that approach conditions could be described as ‘deep’. The curve is shown on *Figure 2.5*, labelled ‘TPW simulation’, and shows reasonable agreement with the published data.

One disadvantage of using thin-plate weir equations to simulate the Larinier fish pass in this study is that operation in the drowned flow range is not permitted in the current thin-plate weir standard, although limited use in the drowned flow range will be permitted in the next edition. We have therefore explored the use of a discharge equation of the type used for the triangular profile (Crump) weir, since this type of structure can be operated in the drowned flow range and suitable equations and software are available. The coefficient of discharge for a Crump weir is approximately 12 per cent higher than for a thin-plate weir, although the latter is variable to some degree. The discharge equation for the Crump weir can be expressed as:

$$Q = b C_{de} (g)^{0.5} (H_{1e})^{1.5} \quad (2.1)$$

where:

$$H_{1e} = H_1 - k_h = h_1 + (v_1)^2/2g - k_h \quad (2.2)$$

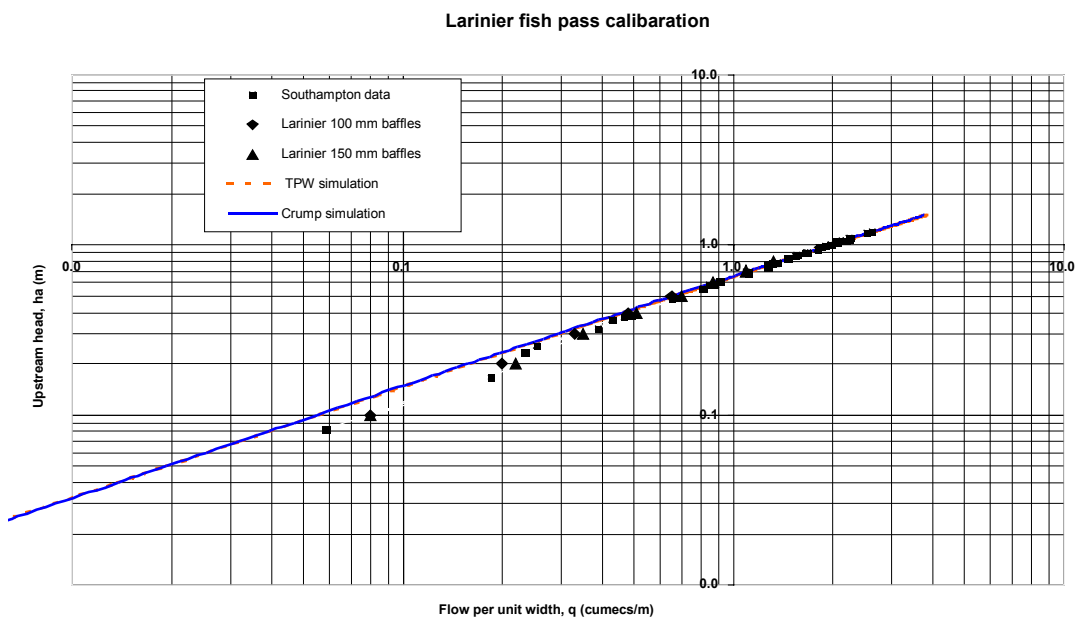
and

$$k_h = 0.0003m \quad (2.3)$$

and where:

- $b$  = crest breadth (m) measured at transverse section of upstream baffle;
- $C_{de}$  = dimensionless coefficient of discharge;
- $g$  = acceleration ( $m/s^2$ ) due to gravity;
- $h_1$  = upstream gauged head (m) relative to transverse section of upstream Larinier baffle;
- $H_1$  = upstream total head (m) relative to transverse section of upstream Larinier baffle;
- $H_{1e}$  = effective upstream total head (m) relative to transverse section of upstream Larinier baffle;
- $k_h$  = head correction factor (m) taking into account fluid property effects;
- $Q$  = flow ( $m^3/s$ );
- $v_1$  = velocity (m/s) of approach at tapping location.

In these equations the value of  $C_{de}$  for the triangular profile Crump weir is 0.633 (Ackers *et al.*, 1978). For comparison with published data for the Larinier fish pass we have reduced this coefficient by 12 per cent to 0.555. A second curve is shown on *Figure 2.5*, labelled 'Crump simulation', based on this assumption. Agreement with published data is reasonable throughout the flow range.



**Figure 2.5 Approximate Larinier fish pass calibration.**

*Note 1.* The Southampton data referred to in *Figure 2.5* are those published by Turnpenny *et al.* (2002b). The Larinier 100 mm and 150 mm baffle results are from Vigneux and Larinier (2002). *Note 2.* The curves are least satisfactory at the low flow end of the calibration. In this region measured flows exceed predictions using the equations. The explanation for this is given in Chapter 4, where it is shown that the actual coefficient of discharge of the Larinier fish pass rises from 0.57 to 0.65 in this low flow region (see *Figure 4.2*). *Note 3.* The current standard for triangular profile (Crump) weirs introduces a numerical constant of  $(2/3)^{1.5}$  in the discharge equation for easy comparison with round-nosed broad-crested weirs. The coefficient of discharge then becomes 1.163 instead of 0.633.

The use of the above Crump weir equation, with a modified coefficient value, is not precise and will not describe satisfactorily the complex three-dimensional flow patterns through a Larinier fish pass at low heads. However, to compute the distribution of flows through a weir–fish pass combination, it is appropriate.

### 2.7.2 Number of Larinier fish pass units for each of the test cases

Flows given in *Figure 2.5* are in  $\text{m}^3/\text{s}/\text{m}$ . Standard Larinier fish pass units are 600 mm wide. Hence, flows per Larinier unit are 0.6 times the flows given in *Figure 2.5*.

Existing recommendations for Larinier units, with 100 mm baffles, suggest that they operate satisfactorily from a hydraulic point of view over a range of upstream heads from 0.18 m to 0.42 m. Corresponding flows per metre width are  $0.15 \text{ m}^3/\text{s}$  and  $0.50 \text{ m}^3/\text{s}$ . Corresponding flows per Larinier unit are  $0.09 \text{ m}^3/\text{s}$  and  $0.30 \text{ m}^3/\text{s}$ .

It has been suggested that the number of units should be related, in some way, to the  $Q_{97}$  river flow. In this study we have taken the maximum satisfactory flow per Larinier unit and compared this with the  $Q_{97}$  value (required attraction flow) for each of the test rivers to give the minimum number of units required. The results are given in *Table 2.7*.

**Table 2.7 Number of fish pass units**

	River width (m)		
	5	10	20
$Q_{97}$ ( $\text{m}^3/\text{s}$ )	0.3	0.6	3.0
Minimum number of Larinier units	1	2	10 (6, see Section 2.5.2)

The results given in *Table 2.7* show the increasing difficulty in achieving the  $Q_{97}$  attraction flow in larger rivers. Ten Larinier units have a total width of 6 m, and this in a river where the channel width is 20 m. Of course, these design figures have been derived using the simple methods outlined in the previous paragraphs. Once the fish pass is installed in a gauging structure–fish pass combination, the flow through the fish pass varies as the river flow varies and is also influenced by the:

- crest level of the fish pass compared with the crest level of the gauging structure;
- hydraulic characteristics of the gauging structure.

Increasing the acceptable design head for Larinier fish passes from 0.42 m to 0.6 m (see Chapter 4) reduces the width of the fish pass required but, all other things being equal, throws more flow over the gauging structure before the minimum design head is reached. These aspects are discussed in more detail in Section 2.8.

*Note.* In the light of the tests described in Chapter 4, the Project Board concluded that the upper limit of a Larinier fish pass with 100 mm baffles could be raised to 0.6 m. The revised upper limit for the Larinier fish pass of 0.6 m would reduce the number of units required from ten to six in the test case that involved a compound weir in a 20 m wide channel. However, the flows in both the weir and the fish pass would be altered by a change in the number of Larinier units and the 'attraction flow' for the Larinier fish pass would only be reached at a higher upstream water level (and a higher river flow).

Sections 2.8 and 2.9 assume the original limit for the Larinier fish pass of 0.42 m, as the work was carried out prior to the laboratory testing of the Larinier fish pass.

## 2.8 Simulation of flows through gauging structure / fish pass combinations

A number of combinations of gauging structures and fish pass were simulated to indicate how flows would be distributed between the gauging weir and the fish pass. The intended combinations are summarised in *Table 2.8*.

**Table 2.8 Summary of gauging structure–fish pass combinations**

<i>Parameter</i>	<i>5 m Crump</i>	<i>5 m Flat-V</i>	<i>10 m Flat-V</i>	<i>20 m compound</i>
<i>Weir</i>				
Weir crest breadth (m)	5.00	5.00	10.00	20.00 total 2.00 low 18.00 high
Weir crest elevation (mAD)	100.28	100.18	100.25	100.93 low 101.23 high
<i>River bed</i>				
Upstream and downstream bed levels (mAD)	100.00	100.00	100.00	100.00
Upstream and downstream bed widths (m)	5.00	5.00	10.00	20.00
<i>Fish pass</i>				
Number of Larinier units	1	1	2	10
Total width of Larinier units (m)	0.6	0.6	1.2	6.0
Elevation of crest of transverse section of upstream baffle (mAD)	100.28 (Case 1A) and 100.10 (Case 1B)	100.18 (Case 2A) and 100.00 (Case 2B)	100.25 (Case 3A) and 100.07 (Case 3B)	100.93 (Case 4A) and 100.75 (Case 4B)

In assimilating the results, the following summary of the test combinations aid understanding:

- Case 1A 5 m channel, Crump weir, fish pass at weir level
- Case 1B 5 m channel, Crump weir, fish pass below weir level
- Case 2A 5 m channel, flat-V weir, fish pass at weir level
- Case 2B Not undertaken
- Case 3A 10 m channel, flat-V weir, fish pass at weir level
- Case 3B 10 m channel, flat-V weir, fish pass below weir level
- Case 4A 20 m channel, compound weir, fish pass at weir level
- Case 4B 20 m channel, compound weir, fish pass below weir level

In the cases designated 'B' the fish pass is set 0.18 m below the level of the (lowest) crest of the weir. This value of 0.18 m represents the minimum head on the Larinier fish pass for suitable flow conditions to be developed. Generally speaking, the lowering of the fish pass increases the percentage of the total flow taken by the fish pass, an effect particularly noticeable at low river flows. At very low flows the situation can arise where there is no flow over the gauging structure at all. These aspects are discussed more thoroughly later in this section.

In Case 2B the fish pass level, using the criteria agreed with the Project Board, coincides with river bed level and a fish pass is obviously not required! Hence Case 2B was omitted.

The calculations were performed in accordance with BS 3680:Part 4B (1986)/ISO 4360:1984 (1986); BS ISO 4377:2002 (2002) and BS ISO 14139:2000 (2000). In all cases the simulations are taken from a minimum stage of 0.01 m, through the modular limit and into the drowned flow range. Each simulation is terminated when the drowned flow reduction factor (DFRF) fell to 0.70 (i.e., the flow, for the particular upstream level, is reduced by 30 per cent from the equivalent modular flow).

The hydrometric performance (i.e., flow distribution over a range of river flows) of the combined fish pass–gauging weir complex has been computed assuming that the fish pass and the measuring weir form separate sections of a compound structure. Details are given in *Table 2.9*.

**Table 2.9 Gauging structure–fish pass configurations**

Case	Calculation unit 1	Calculation unit 2	Calculation unit 3
1A, 1B	Crump weir	Fish pass	N/A
2A	Flat-V weir	Fish pass	N/A
3A, 3B	Flat-V weir	Fish pass	N/A
4A, 4B	Low crest of compound weir	High crest(s) of compound weir	Fish pass

*Note.* *Table 2.9* is not intended to indicate how the sections of the gauging structure–fish pass combination are physically disposed relative to each other. From a calculation point of view this is not relevant.

### 2.8.1 Flows through the gauging structure–fish pass combination

The results indicate the balance of flows between the gauging weir and the fish pass and show the degree to which the requirements for the gauging structure and the fish pass are met.

*Table 2.10* summarises flow distributions at key stages of flow:

1. When the upstream head on the Larinier fish pass reaches 0.18 m, which is the minimum head for conditions within the fish pass to be hydraulically satisfactory.
2. When the upstream head on the Larinier fish pass reaches 0.42 m, which is the head quoted by Larinier for conditions within the fish pass to be hydraulically satisfactory. This figure may be revised (see Chapter 4).
3. When the modular limit condition is reached and the weir–fish pass complex begins to drown. The HR Wallingford software used to determine this condition takes the whole weir–fish pass complex and compares the actual total flow with the computed total modular flow. The modular limit is taken as the condition when the actual total flow has fallen to 99 per cent of the

modular equivalent. It follows that one section of the weir or the fish pass itself is somewhat more heavily drowned. We are not able to quote the precise figure from the output of the software.

4. When drowning has reached the point, for the particular upstream head, where total flows are reduced from the equivalent modular flow by 30 per cent..

**Table 2.10 Summary of flows for test cases**

	Case 1A	Case 1 B	Case 2A	Case 3A	Case 3B	Case 4A	Case 4B
<i>Minimum stage for satisfactory Larinier performance, stage (m)</i>	0.18	0.00	0.18	0.18	0.00	0.18	0.00
Flow through fish pass (cumecs)	0.08	0.08	0.08	0.16	0.16	0.80	0.80
Flow over weir (cumecs)	0.79	0.00	0.21	0.21	0.00	0.30	0.00
Total flow (cumecs)	0.87	0.08	0.29	0.37	0.16	1.10	0.80
Percentage flow through fish pass	9.60	100.00	27.40	43.10	100.00	72.60	100.00
Percentage flow over weir	90.40	0.00	72.60	56.90	0.00	27.40	0.00
<i>Maximum stage for satisfactory Larinier performance, stage (m)</i>	0.42	0.24	0.42	0.42	0.24	0.42	0.24
Flow through fish pass (cumecs)	N/A	N/A	N/A	0.58	0.57	2.89	2.85
Flow over weir (cumecs)	N/A	N/A	N/A	1.79	0.43	2.56	0.47
Total flow (cumecs)	N/A	N/A	N/A	2.37	1.00	5.45	3.32
Percentage flow through fish pass	N/A	N/A	N/A	24.40	56.90	52.70	86.00
Percentage flow over weir	N/A	N/A	N/A	75.60	43.10	47.30	14.00
<i>Modular limit conditions, stage (m)</i>	0.22	0.16	0.32	0.51	0.44	0.82	0.72
Flow through fish pass (cumecs)	0.11	0.18	0.19	0.78	1.03	7.66	8.84
Flow over weir (cumecs)	1.08	0.66	0.91	2.95	2.03	16.26	12.13
Total flow (cumecs)	1.19	0.84	1.10	3.73	3.06	23.92	20.97
Percentage flow through fish pass	9.60	24.10	17.50	20.90	33.60	32.10	42.20
Percentage flow over weir	90.40	75.90	82.50	79.10	66.40	67.90	57.80
<i>Conditions when heavily drowned, DFRF = 0.7, stage (m)</i>	0.43	0.26	0.60	0.88	0.71	1.11	1.00
Flow through fish pass (cumecs)	0.23	0.22	0.31	1.10	1.29	8.85	10.12
Flow over weir (cumecs)	2.10	1.26	2.39	7.34	5.19	25.53	21.95
Total flow (cumecs)	2.33	1.48	2.70	8.44	6.48	34.38	32.07



Percentage flow through fish pass	9.70	15.30	11.60	13.00	19.80	24.90	29.90
Percentage flow over weir	90.3	84.7	88.4	87	80.2	75.1	70.1

*Note.* In Table 2.10

Case 1A: 5 m channel, Crump weir, fish pass at weir level

Case 1B: 5 m channel, Crump weir, fish pass below weir level

Case 2A: 5 m channel, flat-V weir, fish pass at weir level

Case 2B: Not undertaken

Case 3A: 10 m channel, flat-V weir, fish pass at weir level

Case 3B: 10 m channel, flat-V weir, fish pass below weir level

Case 4A: 20 m channel, compound weir, fish pass at weir level

Case 4B c: 20 m channel, compound weir, fish pass below weir level

Full numerical and graphic details, showing conditions throughout the head ranges, are given in Appendix C.

*Note.* In all cases 'stage' is related to the crest level of the gauging weir. This is the mean crest level in the case of the triangular profile Crump weir, the lowest point of the crest of the flat-V weir and the mean level of the lower crest of the compound weir.

### Conclusions to be drawn from Table 2.10

Several conclusions can be drawn from the results shown in *Table 2.10*.

1. There is no Case 2B. The  $Q_7$  criteria for the modular limit produces a flat-V weir for the 5 m wide river in which the lowest point of the crest is 0.18 m above bed level. Lowering the fish pass by 0.18 m to this level is clearly not feasible.
2. In the 5 m wide river, Cases 1A, 1B and 2A, the minimum satisfactory head for fish pass performance (0.18 m) is reached marginally before the modular limit condition. At the maximum satisfactory head for fish pass performance (0.42 m) the fish pass and the gauging weir are heavily drowned.
3. For the 10 m and 20 m wide rivers there is a far more satisfactory sequence of flow conditions, with the fish passes operating through their satisfactory range (0.18-0.42 m) before the modular limit of the gauging structure is reached and drowning commences. In these cases, the head on the fish pass exceeds the maximum desirable head before drowning commences, but the gap is not too significant.
4. Comparing the 'A' cases with the equivalent 'B' cases, it is clear that the fish pass attracts more flow if placed at a lower level than the gauging weir, particularly at low river flows.
5. For fisheries purposes, an 'attraction' flow equivalent to  $Q_{97}$  has been suggested to encourage fish towards the fish pass. In Cases 1 and 2 (A and B), the 'attraction' flow of  $0.3 \text{ m}^3/\text{s}$  is not achieved through the fish pass prior to the onset of drowning. In Case 3 (A and B), the attraction flow of  $0.6 \text{ m}^3/\text{s}$  is achieved when the head on the fish pass reaches 0.42 m and before drowning commences. In Case 4 (A and B), the attraction flow of  $3.0 \text{ m}^3/\text{s}$  is

also achieved when the head on the fish pass reaches 0.42 m and before drowning commences.

In summary, the  $Q_7$  criterion for the modular limit produces relatively low weirs, ideal for measuring low flows, but that operate well into the drowned flow range at higher flows. In the case of smaller rivers, say less than 10 m in width, this criteria means head losses across the gauging structure are relatively small and consequently fish passes are not justified. For larger rivers the  $Q_7$  criterion often indicates the need for a fish pass.

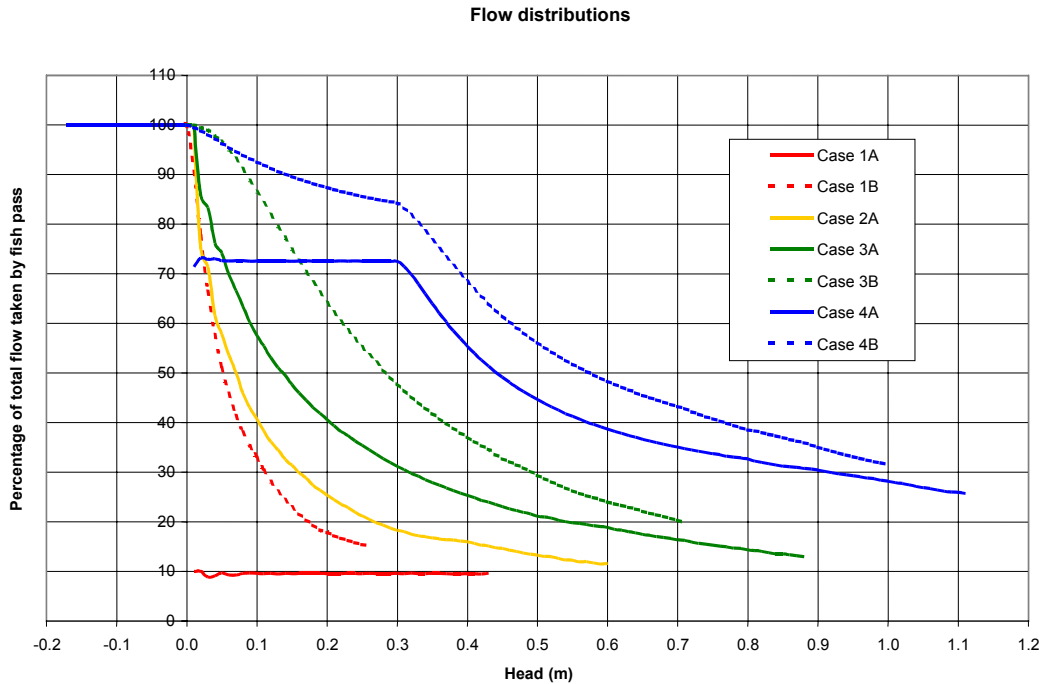
The  $Q_{97}$  criterion for 'attraction' flows to (and therefore through) fish passes is difficult to achieve unless the fish pass has a high capacity compared with the gauging weir and is set below the level of the gauging weir.

*Note.* The results of the experimental work on the Larinier fish pass reported in Chapter 4 suggest that satisfactory hydraulic conditions remain within the fish pass up to 0.6 m head, as opposed to the Larinier recommendation of 0.42 m. Introduction of this new finding as a design criterion for the fish pass would have altered the results described in this section. It is not possible to quantify the differences without reworking all the results.

### **2.8.2 Distribution of flows between the gauging weir and the fish pass**

The test cases covered a range of gauging weirs and a range of fish pass options. The percentage of flow taken by the fish pass varied from case to case and within each case the proportion varied with head. This distribution is an important parameter in determining the overall uncertainty in flow measurement if the uncertainties associated with the gauging weir and the fish pass differ significantly.

The percentage of flow taken by the fish pass is shown for all cases in *Figure 2.6*.



**Figure 2.6 Percentage of total flow taken by the fish pass for all test cases**

Figure 2.6 illustrates clearly the tendency of fish passes to take a high proportion of the total flow, particularly under conditions of low river flow. This effect is enhanced if the fish pass is placed at a lower level than the gauging structure.

### 2.8.3 General conclusions from the flow results

It is not the purpose of this study on uncertainties to make specific recommendations regarding design figures for such things as modular limits for gauging structures or attraction flows for fish passes. There are many technical and non-technical factors that influence decisions, on a site-by-site basis, which go well beyond the scope of the study. The aim of this study is to derive a methodology to determine uncertainties at gauging structure–fish pass combinations, which requires, as a constituent part, that the details of how flows are split between the various sections be determined. To illustrate typical results we have endeavoured to use realistic input data.

The flow results, given fully in Appendix C, cover a range of sizes of river and particular gauging structure–fish pass combinations. However, the designer may be faced with conditions that are not covered in the current study and hence it is important to extract broad conclusions that may be of more general application.

The following general conclusions are drawn.

### **Computation of flows**

The computation of flows using the method described in this section gives important information regarding individual flows through each section of a gauging structure and through the fish pass. This detailed analysis is essential to determine uncertainties (see Section 2.9) and requires the development of suitable software.

### **Modular limits of gauging structures**

The  $Q_7$  criterion for the discharge at which the gauging structure reaches its modular limit leads to the construction of low crest-height weirs, particularly in small rivers, where there is little justification to include a fish pass. Some evidence suggests that gauging structures have been installed with lower flows,  $Q_{>7}$ , at their modular limit. On the other hand, many river structures in the UK (both gauging and non-gauging) are much higher and remain modular to a much higher flow. In general:

- The higher the structure, the higher the discharge at the modular limit. Increasing the crest height gives a wider range of flows, which can be measured in the modular flow range where structures are more accurate. The need for a fish pass increases as the crest level of the gauging structure is raised.
- If the only hydrometric interest at a particular location is in the measurement of low flows, a modest low flow structure can be installed (and operated according to standards in the modular flow range) and the implications to fisheries interests are likely to be minimal. Where the requirements are to measure medium and high flows with accuracy, the need for satisfactory fish passes increases.

### **Attraction flows for fish passes**

The method used to determine the number of fish pass units required for any particular duty seeks to provide a satisfactory flow through the fish pass to attract fish towards the pass. In the present context it is assumed that this flow corresponds with the maximum design head on the fish pass. For the Larinier fish pass with 100 mm baffles, this head is currently quoted as 0.42 m. The flow over the gauging structure when the head on the Larinier reaches 0.42 m depends on the nature and level of the gauging structure relative to the fish pass. In most cases a significant percentage of the total flow will pass over the gauging structure when this condition is reached. In general:

- The lower the fish pass is set relative to the gauging structure, the higher is the percentage of the total flow taken by the fish pass. If the fish pass is set with the upstream baffle below the (lowest) crest of the gauging structure, there will be times when 100 per cent of the total flow is taken by the fish pass. This could potentially have serious implications regarding hydrometric accuracy (see Section 2.9).
- As river flow varies, the gauging structure usually has a major influence on upstream water levels. The influence varies with the type of gauging structure. For example, a flat-V weir increases upstream levels faster than a Crump weir of similar breadth, thus providing greater flow-gauging sensitivity at low-to-medium flows. As a result of this, flows to the fish pass are larger,

all other things being equal, and the rapid head rise at the flat-V weir may take the fish pass flows outside its operating range sooner.

The Project Board is of the opinion that the laboratory testing described in Chapter 4 has shown that the maximum head on a Larinier fish pass with 100 mm baffles may be increased from 0.42 m to 0.60 m. This change indicates that the number of Larinier units may be reduced at a particular site. However, the maximum limit of 0.6 m also introduces changes in the flow distribution between the gauging structure and the fish pass, and the head at which fish pass 'attraction flows' are reached. A full evaluation of the implications to the four demonstration cases was not possible within the current study and requires the development of suitable software.

## 2.9 Uncertainties in flow measurement through gauging structure / fish pass complex

Uncertainties in flow measurement for each of the test cases have been computed using the methodology suggested in current British and International Standards. In particular, we have used the following:

- BS 3680:Part 4B (1986)/ISO 4360–1984 (1986). *Measurement of liquid flow in open channels. Part 4B. Triangular profile weirs*. British Standards Institution.
- BS ISO 4377,2002 (2002). *Hydrometric determinations – Flow measurement in open channels – Flat-V weirs*. British Standards Institution.
- BS ISO 14139:2000 (2000). *Hydrometric determinations – Flow measurement in open channels – Compound gauging structures*. British Standards Institution.

Individual uncertainty values used in the current calculations are those used in the examples in the appropriate standards for Crump and flat-V weirs. Additionally, it has been assumed that only one upstream stage measurement is made, and that this measurement is made at the gauging structure – the lower crest section in the case of the compound weir. This means that the stages at other weir sections, including the fish pass itself, have to be inferred. The compound gauging structure standard indicates the methodology to estimate the additional uncertainty that arises because of this 'transfer' of stage.

The uncertainties sections of the Crump weir and the flat-V weir standards differ in their format and in their treatment of the uncertainties calculations. Furthermore, all standards will need revision in the light of ISO/TR 5168, 1998 *Measurement of fluid flow – Evaluation of uncertainties*, and the *Guide for Uncertainties in Measurement* (GUM), both of which have been published recently by ISO. The Crump weir standard is currently under revision, but neither the flat-V standard nor the compound weir standard will be revised in the near future. Hence, in this study we had no option but to use existing standards despite their shortcomings.

The individual uncertainties assumed are given in *Table 2.11*.

**Table 2.11 Individual uncertainty values**

<i>Parameter</i>	<i>Value of uncertainty (+/-)</i>
<i>Crump weir</i>	
Random uncertainty in coefficient of discharge*	0.5%
Systematic uncertainty in coefficient of discharge*	Defined by equation in standard
Random uncertainty in breadth measurement <sup>†</sup>	0
Systematic uncertainty in breadth measurement <sup>†</sup>	5 mm
Random uncertainty in gauge zero <sup>†</sup>	0
Systematic uncertainty in gauge zero <sup>†</sup>	3 mm
Random uncertainty in head associated with instrumentation <sup>†</sup>	1 mm
Systematic uncertainty in head associated with instrumentation <sup>†</sup>	2.5 mm
<i>Flat-V weir</i>	
Overall uncertainty in cross slope <sup>†</sup>	0.2%
Overall uncertainty in crest breadth <sup>†</sup>	5 mm
Overall uncertainty in weir height <sup>†</sup>	1 mm
Overall uncertainty in head measurement <sup>†</sup>	3 mm
Overall uncertainty in head correction factor*	0.2 mm
Overall uncertainty in coefficient of discharge*	3.2%
<i>Compound weir</i>	
Additional uncertainty in flow at an ungauged section when modular flow is occurring (stage transfer error)*	5%
Additional uncertainty in flow at an ungauged section when drowned flow is occurring (stage transfer error)*	10%

\* Recommended in the standard.

† User defined.

### 2.9.1 Results

Since, at this stage, we do not know the uncertainties in flow measurement through the Larinier fish pass (see Chapter 4), combined uncertainties have been modelled as factors of the overall gauging structure uncertainty (i.e., the total flow through the gauging structure where there is more than one crest section).

Details of how uncertainties at individual sections are combined into the overall uncertainty are given in BS ISO 14139:2000 (2000). *Hydrometric determinations – Flow measurement in open channels – Compound gauging structures*. Uncertainties for each individual section are first calculated taking into account ‘transfer’ errors for ungauged sections. The product of the flow and the uncertainty are then computed for each individual section and the overall uncertainty is the square root of the sum of the squares at each individual section.

The results for all test cases are shown graphically in Appendix D.

### **General**

The following comments relate to all test cases:

- Uncertainties in head measurement, including the zeroing of the gauge, become more significant as the head diminishes. They are particularly noticeable at heads below 100 mm. For compound structures there is a second phase of high uncertainty when the higher crest starts to operate. This effect is very significant when the breadth of the higher crest is large compared with those crests already operating.
- When a gauging weir drowns, additional uncertainties arise because of the need to make two head measurements. The standards assume that a second (downstream) gauge is installed and give methods to estimate these additional uncertainties, but the formulations are relatively simple. In the case of the Crump weir standard, the formulation gives a smooth transition from uncertainties in the modular flow range to uncertainties in the drowned flow range. In the case of the flat-V weir standard the formulation causes a step in overall uncertainty when the gauging weir reaches its modular limit. In reality, drowning occurs progressively and uncertainties increase likewise.
- It is normally only economic to install one upstream head gauge per gauging weir or gauging weir–fish pass complex. Weirs with multiple crest sections and weirs with fish passes alongside suffer additional uncertainties because one or more of the crests do not have a gauge to record upstream head. The standard on compound structures suggests a formulation that indicates the additional uncertainty associated with the transfer of head from a gauged section to an ungauged section. The effect of this becomes apparent as higher ungauged crests come into operation, whereupon a rapid increase in overall uncertainty occurs.
- In the case of compound weirs and gauging weir–fish pass complexes the overall uncertainty depends on the proportion of the total flow that passes through each crest section. For example, if the gauging weir is taking most of the flow with low uncertainty levels and the fish pass, with much higher uncertainty levels, is taking only a small proportion of the flow, the overall uncertainty level remains low. However, if the distribution of flows is reversed, uncertainty levels are high.

In view of the above comments, high overall uncertainties are to be expected when the head on any section of a gauging weir–fish pass complex is low. This effect is exacerbated when the particular crest section is ungauged. Steps in the overall uncertainty curve are to be expected for flat-V weirs when drowning commences. The actual magnitude of the overall uncertainty depends on the distribution of flows between the sections of the complex and the uncertainty levels associated with each section.

In the 'B' cases, where the fish pass is set 0.18 m below the crest of the (lowest) gauging weir, flow takes place through the fish pass before any flow takes place over the gauging weir. We have made the assumption that the uncertainties in fish pass flows are a multiple of the uncertainties in gauging

weir flows. Hence we are not in a position to identify uncertainties in flow when the fish pass alone is operating. However, the fish pass is ungauged and takes 100 per cent of the flow up to a gauged head of zero.

*Reminder.* All heads quoted relate to the elevation of the gauging weir crest (the lowest crest in the case of Compound weirs).

The following comments for each case are based on the plots shown in Appendix D.

**Case 1A 5 m channel, Crump weir, fish pass at weir level**

In this case the fish pass is set at the same level as the gauging weir. The results show the classic pattern of high uncertainties at low heads that diminish as heads increase. The modular limit is reached at a head of 0.22 m (see Appendix C) and uncertainties increase thereafter. The degradation of uncertainty levels caused by the fish pass is low because the gauging weir takes approximately 90 per cent of the total flow throughout the head range.

**Case 1B 5 m channel, Crump weir, fish pass below weir level**

When the head on the gauging weir is small the characteristic high uncertainties occur. The increase in overall uncertainties caused by the fish pass flow are large in the low flow range because the fish pass takes a high proportion of the total flow – 100 per cent when the head is zero, and 33 per cent when the head is 0.1 m. The increase in overall uncertainty above a head of around 0.2 m results from drowning.

**Case 2A 5 m channel, flat-V weir, fish pass at weir level**

Although the crest of the fish pass is at the same level as the centre of the flat-V weir, at low heads the fish pass takes a high proportion of the flow. This is because the fish pass is two-dimensional and the flat-V weir is three-dimensional. Hence there are high overall uncertainties at low heads, which are highly magnified by the presence of the fish pass. The step at a head of 0.32 m coincides with the modular limit.

**Case 2B Not undertaken**

Not undertaken because the design values suggested no need for a fish pass.

**Case 3A 10 m channel, flat-V weir, fish pass at weir level**

The results here are very similar to those for Case 2A, because Case 3A is almost, but not quite, a scaled up version of Case 2A. The same low head pattern is indicated and the modular limit, in this case, is reached at a head of 0.5 m.

**Case 3B 10 m channel, flat-V weir, fish pass below weir level**

This is one of the cases in which the fish pass is set below the gauging weir. The pattern of the results mirrors that of Case 1B, with the additional step at a head of 0.44 m when the modular limit of the flat-V weir is reached.



#### **Case 4A 20 m channel, compound weir, fish pass at weir level**

In this case the flow duration curve indicated the need for a large number of Larinier fish pass units to meet the 'attraction' flow criterion. Hence the fish pass takes a relatively high proportion of the total flow, particularly at low heads.

The results show:

- high overall uncertainties at low heads;
- a rapid rise in overall uncertainties when the higher crest of the compound weir first operates at a head of 0.3 m;
- rising overall uncertainties when the modular limit is passed at a head of 0.8 m;
- large increases in overall uncertainties because of the relatively high flows taken by the fish pass.

#### **Case 4B 20 m channel, compound weir, fish pass below weir level**

This is one of the cases in which the fish pass is set below the gauging weir. The pattern of the results mirrors Case 1B, with the additional and significant step at a head of 0.3 m when the higher crest of the compound weir first operates. The increase in overall uncertainty caused by the addition of the fish pass is large because of the relatively high capacity of the fish pass compared with that of the gauging weir.

### **2.9.2 General conclusions from the uncertainty results**

The computation of uncertainties using the method described in this section gives important information regarding the overall uncertainties through gauging structure–fish pass combinations based on published information in standards.

#### **Uncertainty plots (Appendix D)**

The plots given in Appendix D show how the overall uncertainty varies with river flow for a range of 'typical' situations. The Environment Agency, and anyone else concerned with in water resources or water quality, is interested in the uncertainty of the volume of water that passes a particular location over an extended period. The plots show uncertainties that, under certain conditions, are much higher than the acceptable uncertainty in volumes over extended periods. The time integration, such as flow spill or flow duration percentile analysis, required to assess volumes is not part of this study.

#### **Low heads**

All gauging structures yield high uncertainties at low heads, almost entirely through the difficulties in measuring small values of head. This shows the need to develop highly accurate and stable instrumentation to measure head and also the need to maintain and check this instrumentation regularly.

#### **Compound gauging structures**

Compound structures have the advantage that they can, by design, cover an extremely wide range of flows without undue raising of upstream (flood) levels. However, there is a discontinuity in the uncertainty curve when higher crests come into operation. The much higher overall uncertainties result from

difficulties associated with estimating the head on the higher crest. Two factors come into play:

- the small value of the head;
- the fact that the head is not measured directly, but has to be estimated from the low crest head measurement.

Uncertainties could be reduced by having a second head measurement for the high crest and/or the fish pass, but this incurs additional costs in maintaining the installation and in processing the data.

### **Drowning of the gauging structure**

Gauging structures that can be operated in the drowned flow range were developed to provide flow measurement with little afflux (i.e., little drop in water levels from upstream to downstream). They have applications in canal and river situations where head losses are at a premium. (The Crump weir was developed originally in India, where Edwin Crump had responsibilities for the design of water distribution canals.) In rivers they provide lower structures than would otherwise be needed and have environmental and flood mitigation advantages. However, the operation of standard structures in the drowned flow range involves two measurements of head – one upstream and one downstream. The latter, in the case of Crump and flat-V weirs, is best achieved by measuring the head in the separation pocket, which occurs just downstream of the crest line. Downstream gauges are permitted, but uncertainties in flow measurement are higher.

The standards vary in the way they deal with uncertainties in the drowned flow range. As a general rule, uncertainties during the early stages of drowning are relatively modest. However, they increase as the extent of drowning increases because the two head measurements are attempting to detect smaller and smaller head differences.

### **Gauging structure–fish pass combinations**

A fish pass can be regarded as an additional section of a compound weir. Regardless of the flow measurement uncertainty associated with the fish pass itself, there is additional overall uncertainty because the head upstream of the fish pass is not normally measured directly. Hence, it is subject to the compound weir ‘transfer’ uncertainty.

Research into fish pass design is ongoing and it is significant that no British or International Standards deal with fish pass design. Hence, there are no published definitive hydrometric calibrations of fish passes. In this study we have assumed that the uncertainties in flow measurement at the fish pass are multiples of the overall uncertainties at the gauging structure.

*Note.* In Study C we carried out a detailed hydrometric calibration of a particular type of fish pass – the Larinier fish pass with 100 mm baffles. The results are given in detail in Chapter 4. Under these circumstances, the overall uncertainties of the gauging structure–fish pass combination will generally lie

between the curves given in Appendix D for the 'Weir alone' case and the 'Combination ( $X_{fp} = 2X_{weir}$ )' case.

### **Limitations of demonstration cases**

It is extremely unlikely that the specific parameters used in the demonstration cases will correspond with the river conditions found at a site where a gauging structure–fish pass installation is proposed. Furthermore, the designer will want flexibility in terms of the gauging structure and fish pass arrangements. Hence, the output from these demonstration cases does not provide the appropriate design uncertainties. For this reason it is necessary to apply the methodology, which has been derived in this chapter from first principles, wherever a gauging structure–fish pass installation is proposed, utilising the new Larinier fish pass calibration derived in Chapter 4 when appropriate.

## **2.10 Summary of this investigation of uncertainties at weir / fish pass installations**

The present chapter describes an investigation into the uncertainties that can occur at gauging structure–fish pass installations. A methodology has been derived that considers the hydrometric requirements associated with the gauging structure, the requirements for satisfactory fish pass performance and the available methods to compute flows and uncertainties as defined by British and International Standards. A series of demonstration cases have been evaluated using the derived methodology.

In summary the methodology involves:

1. Assessing the flow characteristics of the river at the location of a proposed gauging structure–fish pass installation.
2. Deriving the design of the gauging structure such that it satisfies the desired hydrometric performance. In particular, setting the crest height to ensure an adequate modular flow range.
3. Deriving the design of the fish pass to ensure that flow conditions are satisfactory within the fish pass and that enough flow passes through the fish pass to attract fish to the pass.
4. Deriving the flow through all sections of the gauging structure–fish pass installation for a range of river flows according to the rules set out in the appropriate British and International Standards.
5. Deriving the overall uncertainty in flow measurement of the gauging structure–fish pass installation for a range of river flows according to the rules set out in the appropriate British and International Standards.

The four demonstration cases show patterns of uncertainties that are likely to occur and provide general advice on those factors that induce high uncertainty values. These demonstration cases are individually very specific, as in the examples below.

#### **Case 4A 20 m channel, compound weir, fish pass at weir level**

It is not true to say that this case applies to any river that is 20 m wide and contains a compound weir and a fish pass at weir level. This specific demonstration case applies to the following, and only the following, parameters:

- River:
  - 20 m wide
  - 0.3 mm sand bed
  - longitudinal slope, 0.00021
  - Manning coefficient, 0.028;
- Weir:
  - compound Crump
  - 2 m central crest
  - 18 m outer crests
  - 300 mm crest height difference
  - crest level set so that it reaches its modular limit at  $Q_7$ ;
- Fish pass:
  - Larinier
  - perceived attraction flow,  $Q_{97}$
  - six units
  - 100 mm baffles.

The demonstration cases are consistent in terms of the way in which the series was set up. They are, however, not of general application to any site for which a combined gauging structure–fish pass combination is being designed.

## 3. Review of trash accumulation and ways to minimise it at fish passes and fish passage aids (study B)

### 3.1 Background

In considering the impact of fish passage aids on flow measurement accuracy at weirs the matter of trash retention and accumulation is of primary importance for two reasons:

- retained trash very quickly makes a pass no longer passable for fish;
- retained trash may change the flow calibration for the weir (or weir and fish pass combination) at a gauging station.

This latter point is of great significance where accurate low flow gauging is a high priority. Traditionally, local Environment Agency fishery officers have accepted that passes have to be inspected and trash cleared manually on a regular basis. This has serious implications as to Health and Safety for Environment Agency personnel. Any improvement in the present arrangements to prevent trash accumulating would therefore increase the efficiency of passes, improve flow measurement accuracy and reduce maintenance costs to the Environment Agency.

### 3.2 Objectives

1. To review the methods in use to minimise trash accumulation on in-river structures, both in this country and abroad. Restrict the review to simple design techniques or trash deflectors rather than include complex mechanical solutions, such as automated trash screen cleaning devices.
2. To provide guidance on the design and selection of fish passage aids that minimise the impact of trash.
3. To recommend further desk or laboratory studies required.

### 3.3 Methods employed

This review of trash problems at fish passes and fish passage aids was contracted to Professor Robert Sellin, recently retired from the University of Bristol as Professor of Hydraulic Engineering. It included:

1. discussions between relevant Environment Agency and HR Wallingford staff on field experience and advice;
2. field visits to inspect a range of fish passes, to discuss their operational aspects with the responsible fishery officer; and to gather photographs;
3. implementation of an international literature review.

Throughout this project particular attention was given to the extent of trash build-up on different fish pass types, concentrating on those preferred fish pass arrangements identified in White and Woods-Ballard (2003), namely pool and traverse, and various side and/or bottom baffle arrangements.

Factors investigated included:

1. fish pass and weir configurations;
2. locations and arrangements of entrances of fish passes relative to weir structures (including submerged or non-submerged flow entrances or different orientations);
3. width of passes relative to weir structure;
4. seasonality and flow regime effects on trash accumulation;
5. use of different trash deflector devices (e.g., floating booms, fins, fixed screens).

## 3.4 Data collection

### 3.4.1 Preliminary discussions

Early discussions were held with key Environment Agency staff to appreciate the background and objectives to the study, to discuss the methodology and to seek contact names of Environment Agency staff best placed to provide assistance:

- Greg Armstrong, National Fish Pass Officer, Devon;
- Rachel Tapp, Overall Project Manager, Birmingham.

### 3.4.2 Fieldwork

The fieldwork for this study was carried out during October and November 2003. This was a season in which levels on all the rivers, with the exception of the River Taff, were unusually low for the time of year.

It was important that a wide selection of fish passage aids and trash minimisation solutions in England and Wales were examined within the time constraint set for this work. *Table 3.1* lists the 41 fish passage aids reviewed, although the selection of sites was dependent on the Environment Agency fisheries or hydrometric staff voluntarily responding to email requests for assistance and may not therefore represent the full range of fish passage aids in the UK.

All were visited and photographed, with the exception of Appendix E (15, 16 and 17) and all visits were made together with an email Agency fishery officer, except (10). Only the Anglian Region in England was not visited at all, since this region has no migratory salmonids and thus very few existing fish passes (although some are now being built for coarse fish species). Visits in Wales were confined to the Cardiff area. The fish passage aids reviewed here represents approximately 5–10 per cent of the fish passage aids in England and Wales.

Data are presented on a single page Fish Pass Record for each pass, given in Appendix E. Each record is given a reference number and contains essential data, including location, pass type and Environment Agency contact. Text panels summarise the trash position, trash minimisation techniques currently employed and other features of the site. In addition, photographs have been selected that illustrate the location of the pass in relation to the weir or other river obstacle, and details of any trash deflector or screen fitted.

### 3.5 Discussion of data

While it is true to say that no two fish passes are the same when taken in the context of their specific location, it is convenient here to discuss them by type. Two sites visited fall outside the normal categories and are therefore included in a miscellaneous category.

**Table 3.1 Location and classification of fish passes and easements examined (full reports in Appendix E)**

<i>Serial No.</i>	<i>Region</i>	<i>Area</i>	<i>River</i>	<i>Site name</i>	<i>Fish passage aid</i>	<i>Weir or obstruction type</i>	<i>Trash minimisation technique</i>	<i>OS Reference</i>	<i>Contact</i>
RS/FP/01	North East	Dales	Kyle	Newton-on-Ouse	Baffles	Flat-V weir	None	SE 508 603	Paul Frear
RS/FP/02	North East	Dales	Tutt	Boroughbridge	Pool and traverse	Broad-crested weir	None	SE 395 670	Paul Frear
RS/FP/03	North East	Dales	Ure	Alma Weir, Ripon	Pool and traverse	Flat-V weir	None	SE 319 709	Paul Frear
RS/FP/04	North East	Dales	Ure	Westwick Weir	Baffles	Broad-crested weir	None	SE 355 670	Paul Frear
RS/FP/05	North East	Dales	Ouse	Naburn Weir	Pool and traverse	Broad-crested weir	Timber frame boom	SE 593 445	Paul Frear
RS/FP/06	North East	Northumbria	Coquet	Coquet Lodge, S. Pass	Pool and traverse	Broad-crested weir	Vertical bar screen	NU 237 060	Phil Rippon
RS/FP/07	North East	Northumbria	Coquet	Coquet Lodge, N. Pass	Plane baffle Denil	Broad-crested weir	Screen	NU 237 060	Phil Rippon
RS/FP/08	North East	Northumbria	Coquet	Acklington Dam	Pool and traverse	Broad-crested weir	Horizontal bars	NU 203 029	Phil Rippon
RSFP/09	North East	Northumbria	Wansbeck	Morpeth, Oliver Weir	Plane baffle Denil	Broad-crested weir	Metal hood	NZ 199 858	Phil Rippon
RSFP/10	North East	Northumbria	Wear	Durham	Pool and traverse	Broad-crested weir	None	NZ 272 425	Phil Rippon
RS/FP/11	North West	Central	Lune	Broadraine	Pool and traverse	Broad-crested weir	Vertical bar screen		Steve Whittam
RS/FP/12	North West	Central	Leck	Cowan Bridge	Pool cascade	Natural barrier	None		Steve Whittam



RS/FP/13	North West	Central	Dunsop	Footholme: abstraction	Baffles and P&T	Abstraction weir	None	SD 533	653	Steve Whittam
RS/FP/14	North West	Central	Dunsop	Footholme: gauging station	Transverse baffles	Compound flat-V weir	None	SD 532	653	Steve Whittam
RS/FP/15	North West	North	Kent	Barely Bridge, Staveley	Denil and pool	Broad-crested weir	Post deflector	SD 987	470	Graeme McKee
RS/FP/16	North West	North	Kent	Burneside	Pool and traverse	Broad-crested weir	Post deflector	SD 962	504	Graeme McKee
RS/FP/17	Midland	Lower Severn	Stour	Alscot Park gauging station	None	Broad-crested weir	Floating finned boom	SP 507	208	Peter Ridley
RS/FP/18	Thames	Central	Thames	Caversham	Larinier	Broad-crested weir	Semi-circular deflector	SU 741	720	Darryl Clifton-Day
RS/FP/19	Thames	Central	Thames	Hurley	Alaskan-A Denil	Broad-crested weir	Semi-circular deflector	SU 842	821	Darryl Clifton-Day
RS/FP/20	Thames	Central	Thames	Sonning	Plane baffle Denil	Broad-crested weir	Semi-circular deflector	SU 755	752	Darryl Clifton-Day
RS/FP/21	Thames	Central	Thames	Goring	Alaskan-a Denil	Broad-crested weir	Plate deflector	SU 815	600	Darryl Clifton-Day
RS/FP/22	Thames	Central	Kennett	Southcote weir	Plane baffle Denil	Canal traverse	Plate deflector	SU 711	690	Darryl Clifton-Day
RS/FP/23	Thames	Central	Kennett	Southcote sluice	Larinier	Canal traverse	Plate deflector	SU 712	692	Darryl Clifton-Day
RS/FP/24	Wales	South East	Taff	Blackweir	Plane baffle Denil	Broad-crested weir	Screen and deflector	ST 780	171	Mike Parfitt
RS/FP/25	Wales	South East	Taff	Radyr	Plane baffle Denil	Broad-crested weir	Screen and deflector	ST 808	131	Mike Parfitt
RS/FP/26	Wales	South East	Taff	Treforest	Pool and traverse	Broad-crested weir	Bar screen and boom	ST 889	084	Mike Parfitt
RS/FP/27	Southern	Hants and Isle of Wight	Meon	Titchfield Mill	Alaskan-A Denil	Canal traverse	Bar screen	SU 055	541	Adrian Fewings

RS/FP/28	Southern	Hants and Isle of White	Meon	Funtley Bridge	Plane baffle Denil	Mill leaf traverse	Plate deflector	SU 087	553	Adrian Fewings
RS/FP/29	Southern	Hants and Isle of Wight	Itchen	Bishop Stoke Lock	Side baffle pass	Flood control structure	Plate deflector	SU 196	463	Adrian Fewings
RS/FP/30	Southern	Hants and Isle of Wight	Itchen	Itchen Navigation	Pool and traverse	Canal traverse	None	SU 223	467	Adrian Fewings
RS/FP/31	South West	North Wessex	Avon	Kellaways	Larinier	Broad-crested weir	Screen and boom	ST 759	948	Catherine Prideaux
RS/FP/32	South West	North Wessex	Avon	Keynsham Weir	Pool and traverse	Broad-crested weir	Screen	ST 689	660	Catherine Prideaux
RS/FP/33	South West	North Wessex	Chew	Keynsham Park Weir	Plane baffle Denil	Broad-crested weir	Vertical bars	ST 685	657	Catherine Prideaux
RS/FP/34	South West	Devon	Otter	Otterton	Pool and traverse	Broad-crested weir	None	SY 855	081	Nigel Reader
RS/FP/35	South West	Devon	East Okement	Okehampton	Pool and traverse	Natural barrier	None	SX 952	590	Nigel Reader
RS/FP/36	South West	Devon	Okement	Monkokehampton	Plane baffle Denil	Broad-crested weir	Vertical deflector bar	SS 051	582	Nigel Reader
RS/FP/37	South West	Devon	Taw	Eggisford	Pool and traverse	Broad-crested weir	None	SS 115	683	Nigel Reader
RS/FP/38	South West	Devon	Mole	Head Weir	Alaskan-A Denil	Broad-crested weir	Screen deflector and	SS 185	666	Nigel Reader
RS/FP/39	South West	Devon	Exe	Trews Weir	Diagonal baulk	Broad-crested weir	None	SX 916	924	Nigel Reader
RS/FP/40	South West	South Wessex	Moors	Hurn Weir	Baffles	Flat-V weir	None	SZ 968	126	Andy Strevens
RS/FP/41	South West	South Wessex	Stour	Throop Mill	Fish lock	Broad-crested weir	None	SZ 958	112	Andy Strevens

### 3.5.1 Pool and traverse fish passes

In all, 15 of the passes examined fall into this category. Usually these are constructed to one side of the obstacle or even in a bypass. In some cases they are integrated with the obstruction and follow the low flow route. They vary from the textbook model, Otterton (34), to the one constructed within the natural rock channel of the East Okement at Okehampton (35). The 15 passes are as follows:

03	Alma Weir, Ripon	16	Burneside
05	Naburn	26	Treforest
06	Coquet Lodge, South	30	Itchen Navigation
08	Acklington	32	Keynsham Avon
10	Durham Weir	34	Otterton
11	Broadrairie	35	Okehampton
12	Leck Beck	37	Eggisford
13	Footholme, Abstraction		

In general, pool and traverse passes do not block from light trash alone but they need some protection against heavy material, such as tree branches and floating timber. In rivers that have mobile bed sediments, such as cobble and gravel, they can also suffer sometimes from sedimentation.

### 3.5.2 Denil baffle fish passes

Denil baffle passes usually employ baffles on the side and/or bottom of a relatively narrow (<1.2 m wide) and steep (15-25 per cent) channel. There are two main types of side and bottom baffle Denil pass in use in England and Wales. These are the plane baffle Denil and the Alaskan-A Denil. Fish passages with side baffles only can also be employed, and these have been included here. This group, numbering 14 passes, is listed below:

07	Coquet Lodge, North	24	Blackweir
09	Oliver Weir, Morpeth	25	Radyr Weir
15	Barely Bridge	27	Titchfield Mill
19	Hurley Weir	28	Funtley Bridge
20	Sonning Weir	29	Bishop Stoke
21	Goring Weir	36	Monkokehampton
22	Southcote Weir	38	Head Weir

These passes must be narrow to work effectively. They are, therefore, prone to block if trash of a length equal to or greater than the passage width is allowed to enter. Once an internal bridge is formed in this way, smaller material rapidly accumulates at the site. Deflectors may not be effective and some form of screen will then be required at the upstream entrance. Provision must be made for easy and safe cleaning of any screen fitted.

### 3.5.3 Bottom baffle fish passes

As the name implies, this type of pass has baffles only on the bottom of a channel. The channel can be moderately steep (10-15 per cent). While the width is not limited by hydraulic constraints in the same way as for Denils, they are generally shallower structures than the latter. The only type utilised in England and Wales currently is the Larinier Super-active baffle pass, and in the past ten years this has been used extensively in new constructions. Despite its increasing popularity, only three examples were seen during this study:

- 18 Caversham Weir
- 23 Southcote Sluice
- 31 Kellaways.

The relatively wide nature of these passes, together with the up-welling turbulent pattern of flow that tends to wash material through, reduces the risk of trash catching in these channels. However, the roughness offered by the baffles has the potential to trap heavier and angular debris, and also large sediment-like cobbles and rocks that are moved at high river discharges. Deflectors employed to divert larger items of debris are likely to be an advantage.

### 3.5.4 Fish passage easement approaches

The traditional baulk fish passage, which consists of either a wooden or masonry baffle set at an angle across a sloping weir glacis, is represented here by Trews Weir (39). Several experimental passage easements have also been built recently by fixing an array of baffles in novel patterns on the downstream face of low gradient weirs (flat-V weirs or sloping Crump-type weirs). These are of interest as they offer a potential solution for retrofitting on certain types of gauging structures, if the conditions are right. The examination of five passages that fall into this category has been made:

- |    |                                |    |                      |
|----|--------------------------------|----|----------------------|
| 01 | Newton-on-Ouse gauging station | 39 | Trews Weir           |
| 04 | Westwick Weir                  | 40 | Hurn gauging station |
| 14 | Footholme gauging station      |    |                      |

Although such easements are unlikely to block completely, the accumulation of even small amounts of debris may affect accuracy, in the case of gauging stations, and inhibit fish passage at low flows. An upstream deflector may serve to hold trash in a non-critical location until it can be cleared.

### 3.5.5 Miscellaneous

The first of these sites is the fish lock at Throop Mill (41), which is a form of pass rarely encountered. It is not in constant operation, but is used as required. Owing to its nature, it is not vulnerable to blocking by trash. The other is the low flow weir at Alscot Park (17), which forms part of a gauging

structure. The structure does not serve any fish pass function, but does have a lengthy history with trash issues and efforts, some novel, to try to overcome this. It is therefore included in this report and discussed separately.

### 3.6 Literature search

An on-line literature search revealed no additional material to add to that already available. A wide literature deals with the design and behaviour of fish passes, but there is only limited reference to the trash problem. The significant publications found were:

1. White and Woods-Ballard(2003) *The investigation and specification of flow measurement structure design features that aid the migration of fish without significantly compromising flow measurement accuracy, with the potential to influence the production of suitable British Standards.* Environment Agency R&D Technical Report W6-084/TR1.
2. Turnpenny *et al.* (2002a) *Fish passages at flow gauging stations in England and Wales. Stage 1: Literature review and regional survey.* Environment Agency R&D Technical Report W6-029/TR1.
3. Turnpenny *et al.* (1998) *A UK guide to intake fish-screening regulations, policy and best practice.* ETSU H/06/00052/00/00.
4. Larinier *et al.* (2002) *Fishways: biological basis, design criteria and monitoring.* Bulletin Français de la Pêche et de la Pisciculture, **364**, 208pp.
5. Washington Department of Fish and Wildlife (2000). *Fishway guidelines for Washington State, Trash rack and other design details.*  
<http://www.water.gov/wdfw/hab/ahg/fishguid.pdf>

Turnpenny *et al.* (2002a) concludes that ‘the accumulation of debris was considered to be a key factor determining the accuracy of gauging the fish pass component of flow....’ and they recommend that provision be made for frequent clearing by the responsible staff.

Turnpenny *et al.* (1998) deals with the problem of screening power station water inlets to prevent fish entry. Some details are given of mechanically operated raked bar screens that have an application in trash removal, but these would not normally be a feasible option with respect to this study because of their cost.

Larinier *et al.* (2002) refers to various classic means employed at water intakes (including fish passes) to protect against floating debris. It recommends that where bars are used in a trash rack they should have a free gap of 250-300 mm for large salmonids, and that the screen should be installed where a through-screen velocity  $\leq 0.3-0.4 \text{ ms}^{-1}$  can be achieved. Where fish passes are concerned, this normally results in an extension to the upstream end of the pass to achieve both the velocity criteria and a lateral location to the fishway entrance that encourages trash to bypass the facility. It recommends that the trash rack–fishway entrance should not be located in a re-circulating area and that it is desirable to engineer it to ensure a strong enough current across the face of the trash rack to carry debris away. These features should help ensure the effectiveness of the screen and prevent trash

returning to block the screen when operational cleaning takes place. Five schematic drawings are given that illustrate these points.

Washington Department of Fish and Wildlife (2000) recommends the same spacing for vertical bar trash racks as Larinier does, but adds that any additional horizontal bars should be 500 mm apart. Further design details for trash racks are also included.

Armstrong *et al.* (2004) repeats the advice given in Larinier *et al.* (2002). It makes reference to the fact that some types of pass are more prone to blockage and/or trash problems than others. For example, bottom-baffle only passes are less of a maintenance problem than side-and-bottom baffle types. It suggests that bottom-baffle only types may not need protection against trash in many circumstances. Where there is any doubt it is recommended that protective debris screens or shields be employed. Where solid deflectors are used it recommends designing so that no acceleration in water velocity (that would drag trash in) is caused under, through or around them and that they are located a minimum of 1.5-2.0 m upstream of the pass invert. Surface mounted deflectors should have a minimum of 0.4 m free gap underneath them. Trash protection facilities should be designed and located carefully to minimise maintenance operations. Remote surveillance of the facility is recommended wherever possible to detect any problems with trash and to avoid unnecessary site visits. A short section on remote surveillance is given later in the same document (p. 215).

## 3.7 Factors that influence trash retention at fish passage aids

### 3.7.1 Definitions

Trash can be defined as any mobile solid material found in a river. If it floats it will move at the water surface. Neutrally buoyant material, such as waterlogged twigs and leaves, may be anywhere in the water column, while dense material (sand, gravel) will retain at least partial contact with the bed and move by sliding, rolling or hopping (saltation).

An *on-line fish pass* is one that, in effect, provides the low flow channel at the weir or obstruction. There is no sharp distinction between the flow in the pass and in the rest of the river cross-section at that point.

An *off-line fish pass* is considered here to be one separated from the rest of the river flow at all states of the river by an impermeable barrier, which may be a simple concrete wall, or constructed in a bypass channel. These passes may be either in the centre or to the side of the weir, and will be hydraulically separate from the rest of the river flow, although sharing the same water levels at inlet and outlet.

### 3.7.2 On-line fish passes or fish passage aids

Such passes are built into the obstruction in such a way that they carry the entire low flow in the river, and form part or all of the flow cross-section as the river rises. As they are essentially open passes the choice of type is restricted to pool and traverse (02, 13, 30, 35, 37), baulk (39) or bottom-mounted baffles – the ‘easement’ approach (01, 04, 14, 40).

Open, streambed passes may be attractive from the trash situation, since they will be cleared of most trash when the river rises. However, if this is not acceptable (it would not be for a gauging structure, for instance) the use of fixed or floating deflectors should be explored. These can be installed upstream of the weir–fish passage and arranged so that trash is drawn towards the bank, where it will be trapped for later removal. Such an arrangement is indicated in *Figure 3.2f*, in which it is applied, notionally, to the pool and traverse pass in (35).

In difficult conditions (cobble, boulders likely to move) streambed pass structures must be robust enough to stand the wear and tear to be found in such a location (13). They must also be easy to empty of sediment.

### **3.7.3 Off-line fish passes or fish passage aids**

The prevention of trash reaching a fish passage upstream entrance is clearly a desirable objective. Trash will mainly be a problem where there is significant deciduous growth within the catchment. Urban trash can also be a problem. There are several ways to mitigate the effects of trash, but they are not universally effective.

Trash accumulation may result where some form of deflector or trap is provided upstream of the pass entrance, see Appendix E (42), a litter trap seen in Melbourne, Australia. It is less likely to occur in rivers in which the circulation present in the river flow immediately upstream of the pass causes all trash to pass well away from the entrance, see Appendix E (34), and *Figure 3.1c*. In any of these situations there may still be a troublesome bedload.

Other factors that determine how much trash reaches a pass entrance are the location and orientation of the entrance, the relative proximity of the main weir crest and the proportion of the total river flow taken by the pass. This latter will change with season and the weather, since these will influence the river discharge. The lateral location of a fish pass is recommended, since this will encourage trash to bypass the entrance, and some examples are given in the *Environment Agency Fish Pass manual (Armstrong et al., 2004)*. Under some circumstances a submerged inlet may attract less trash, but provision must be made for the removal of any that enters.

If an off-line pass receives a significant trash load, three scenarios must be considered if frequent blockages are to be avoided:

1. allow the material to pass through the fish passage, if the size and nature of both trash and passage allow;

2. deflect it into an alternative path, usually over the weir;
3. retain it on a trash rack or by using a deflector for later removal.

Option 1 is usually preferred, but remembering that a tree may need to be removed from the pass from time to time. If this is unacceptable, Option 2 must be adopted, but if the deflector fails to function properly Option 3 will be necessary. Option 3 is a costly choice for fish passes, as either machinery or manpower to remove the trash is required on a regular basis, with all the associated health and safety issues.

If the obstruction is a gauging structure the priorities may change as the gradual accumulation of trash at the site may change the calibration. It may be preferable to deflect the trash to the high flow element of a compound weir-pass system, where its impact on flow accuracy may be less. This is unlikely to succeed if there is little or no flow over that element.

### **3.7.4 Anti-trash approaches and devices**

#### **3.7.4.1 Screens**

In some cases a screen will be essential, but it must be remembered that screens by their very nature – they simply trap debris – will never work unattended. Clearly, the amount of cleaning that a screen requires will depend on the type and density of trash in the watercourse in question, and factors such as screen size and location. Vertical or near vertical bar screens are common, and are generally easily cleared manually, so long as a secure walkway is provided close to the screen and at a convenient height (*Figure 3.2a*). Some shown in Appendix E (11 and 33) are good in this respect, while others in Appendix E (24, 26 and 31) are poor.

Passes shown in Appendix E (11, 24, 25, 26, 27, 31, 33, 36 and 38) are all fitted with bar screens that need regular manual clearing. In the autumn, wet leaves wrap around bars and this material continues to build up rapidly until the screen is completely blocked.

More widely placed screens (*Figure 3.2b*) may be used to prevent children, canoeists, etc., being drawn into covered passes. These may also make more effective trash screens, as shown in Appendix E (33).

Accumulated trash on screens can cause a head difference to develop across the screen, which may reduce flow and thus interfere with the attraction to the downstream entrance of a fish pass or the accurate measurement of flow at a gauge.

#### **3.7.4.2 Fixed deflectors**

Fixed deflectors are normally designed to shed floating trash and to encourage its movement to less sensitive areas. This may mean directing it to carry on over the weir, or else to a collection point where it may be removed. Normally, these consist of metal plates that sometimes entirely surround the pass entrance (in plan) and dip into the water far enough to form a barrier to floating material. Frequently they are designed to be 250-300 mm below the



low river discharge water level. The amount of freeboard provided must take into account the expected variation in river level at that point, to avoid the deflector being over-topped too frequently.

Metal deflectors may be either straight or curved. Passes 22 and 23 have straight deflectors perpendicular to the flow. Passes shown in Appendix E (25, 28, and 29) have straight, but inclined, deflectors in close proximity to the pass entrance. In both cases the flow area available for the water to enter the pass is thereby restricted, which raises the velocity locally, and thus increases the risk of trash being drawn under the deflector (*Figure 3.2a*). Guidelines in the *Environment Agency Fish Pass Manual* (Armstrong *et al.*, 2004) suggest that the minimum gap under a deflector be 400 mm, but also that there should be no increase in velocity to values in excess of that entering the pass. Locating the deflector in deeper water (*Figure 3.2c*) reduces the risk compared with a location in shallow water (*Figure 3.2d*).

1. *Straight (flat plate) deflectors* are normally used when a pass entrance is in or adjacent to the river bank. They work better when sited some distance away from the pass entrance than in close proximity to it. If fitted inside the pass channel there is no route for the trash to take other than under the plate or through removal from above by some means. Some flat deflectors are fitted across the pass entrance at an acute angle to the path axis. Where this can lead directly on one side to a weir crest, as in Appendix E (21), this could be a good arrangement (*Figure 3.1a*). Deflectors can sometimes be used to divert trash to a collection area for removal (*Figure 3.2f*). Deflectors that take the form of bar screens, as in *Figure 3.2e* and Appendix E (36), will soon block, so are only effective as deflectors rather than screens.
2. Straight deflectors are sometimes used to form a *V-shaped 'breakwater'* ahead of a pass, as in *Figure 3.2g* and Appendix E (24 and 38). These can cause trash to enter the re-circulation area behind them rather than float clear of the pass. In this case, over-sizing the width could well reduce this problem.
3. If the location is suitable, a *curved, usually semi-circular*, deflector plate the same width as the fish pass allows a larger cross-sectional area for the pass feed water to pass under them than do straight ones. This reduces the velocity in this region, and with it the risk of trash being drawn down. Passes shown in Appendix E (18, 19 and 20) have this form. They also seem more effective at deflecting the trash they intercept onto the neighbouring weir. Therefore, the depth of water below the deflector plate is an important design feature – the more the better. An improvement on the existing designs may therefore be a form that overlaps the sides of the pass, as shown in *Figure 3.2h*. Curved deflectors are used mainly on passes built into long weirs (on the River Thames, for example).
4. A variant of the curved deflector plate is the *hooded curved deflector* that is enclosed at the top and thus removes the chance of trash ingress over the deflector. An example is shown in *Figure 3.2i* and Appendix E (09).
5. A different type of deflector is shown in *Figure 3.2k*, Appendix E (15 and 16) in which *timber poles* driven into the streambed appear to operate as

part screen and part deflector. They are cheap to construct, and also inconspicuous (if that is a factor).

Fixed deflectors are designed to deflect floating trash, but if maintenance costs are to be kept low there must be an alternative path for the trash once it has been collected in front of the deflector. A commonly encountered problem is that there is no effective alternative path for trash, and it thus accumulates at the deflector and causes a blockage unless any build up is removed on a very regular (and thus costly in manpower terms) basis.

Trash that collects at the deflector will only be carried away towards a neighbouring weir or sluice if the surface currents are sufficiently high. It is the balance between the currents (a) drawing trash into a fish pass and (b) drawing it to an alternative path that determines how successful a deflector will be, and this needs to be carefully considered.

With the possible exception of the V-shaped breakwaters, fixed deflectors are usually designed to prevent the ingress of floating or partially submerged debris. In fact, fish pass guidelines (Armstrong *et al.*, 2004) give requirements for a minimum free gap under the deflector. They are therefore ineffective often in preventing the entrainment of either sunken neutrally buoyant or demersal debris.

#### **3.7.4.3 Floating booms**

Two examples of inflated booms are shown in Appendix E (04 and 26). The first is there to warn boaters and the second appears ineffective as a trash barrier. The floating metal cylinder fitted with a rigid skirt on Alscot weir, Appendix E (17), seemed much more effective. As a result of the design of what is, in effect, a compound gauging weir, the whole river flow passes under this boom when the river is low. Under these conditions it will not be able to deflect a heavy trash load, as seen in the photograph in Appendix E (17), because there is nowhere for it to go. However, under circumstances in which there is an alternative route for the trash, as shown in *Figure 3.2l*, this arrangement could be effective.

Another floating structure was seen on the Ouse at Naburn, Appendix E (05). It has the appearance of an open timber framework, moored to the bank, and could be a trash deflector.

1. The same principles apply to floating booms as those discussed above for fixed deflectors. So long as they are effective in retaining floating trash they have the added advantage of maintaining a constant depth of immersion, or cut-off depth, as the river level changes. Evidence suggests that they work better with a fin or skirt added, as shown in *Figure 3.1b*.
2. If the boom is a timber pole – a telegraph pole would be suitable – a sheet metal fin should be attached lengthwise and will hang downward by gravity (albeit skewed slightly by the current). Both ends should be retained in their correct position by a loose metal ring around a fixed vertical post. Care must be taken to ensure that this sliding connection cannot jam.

3. The downstream fixture, at the weir crest end, should allow for some non-verticality in the posts – perhaps incorporating a short length of chain. The boom should be located in deep water and as long as can be accommodated. Again, the downstream end should feed trash easily onto the adjacent weir crest or other outlet.

By definition, the booms are designed to prevent floating trash and therefore, like the majority of fixed deflectors, they are ineffective in preventing the entrainment of either sunken neutrally buoyant or demersal debris.

3.7.4.4 Positioning and orientation of intakes for enclosed passes on **weirs**  
Some fish passes have been located well away from the banks, sometimes even centrally in a structure with water passing on either side. This has been justified to avoid poaching or vandalism. The two shown in Appendix E (09 and 38) are side-baffle fish passes that are very prone to blockage, both internally and at the obligatory upstream screens. These are dangerous to reach and cumbersome to clear, so this mid-weir location should be avoided because of the maintenance problems that arise. Generally, today most passes would be located at the banks, since most fish would be expected to follow the banks in their upstream migration.

Given the potential problem from floating, neutrally buoyant and demersal debris, it may be appropriate to employ a laterally positioned (good sweeping characteristics) and submerged orifice (plate top and bottom to deter floating and demersal debris) opening for fish passes.

## 3.8 The choice and use of anti-trash devices at weirs

Where there are important structures, such as fish passes or gauging stations, that are sensitive to issues with trash, it is sensible to monitor them using remote surveillance techniques. This would help improve performance while reducing manpower requirements (site visits to check for debris accumulation).

### 3.8.1 Flat-V weirs

Flat-V weirs are essentially flow measurement structures, especially valuable when low-flow measurements are high priority. From the fishery angle these structures may lend themselves to fish passage easement techniques, as the weir shape concentrates the low flow on the centreline of the weir, below which baffle arrangements can be grouped.

Anti-trash measures should be considered, since the accumulation of even small quantities of trash at the 'V' apex under low flows may have a serious effect on the weir calibration coefficient. The use of fixed or floating deflectors should be explored. These can be installed upstream of the weir and arranged so that trash is drawn towards the bank where it will be trapped for later

removal. Such an arrangement is indicated in *Figure 3.2h*, in which it is applied to the pool and traverse pass in (35).

### 3.8.2 Crump weirs

Crump weirs are characterised by low heads on the horizontal crest compared with the flat-V weir. There is therefore a higher risk of trash accumulating at the crest. An upstream deflector and/or trap, as discussed above, should thus be considered.

### 3.8.3 Horizontal broad-crested weirs

To achieve the required gradient a fish pass constructed for a broad-crested weir will usually be an off-line structure. A submerged inlet will be more difficult to keep clear of trash than a free surface one, but note that the amount of trash that enters will depend on the location and design of the inlet. Careful observations should be carried out at a proposed new pass site to determine the best location.

### 3.8.4 Non-gauging weirs and natural obstructions

In this case a discharge calibration is not required so a solution may be adopted that is best for the fish. A streambed pass should certainly be considered (14) if the construction costs are acceptable, remembering that the projected ongoing maintenance costs of the pass should be included in this assessment. Denil passes are highly susceptible to blocking and difficult to clear and so, if adopted, must be protected by screens with good access for cleaning. It is also unwise to place these in mid-stream, again because of access, as shown in Appendix E (09). A metal plate deflector may be adequate in some circumstances. However it is wise to ensure that there is a sweeping current component to carry trash to a position where it can either be collected and removed easily or simply swept over the obstruction. It is also necessary to ensure that the deflector is long enough to carry trash well clear of the entrance to the pass, from where it has no chance of being drawn back in. A submerged orifice-type opening as discussed above (Section 3.7.4.4) may be used where possible (but is difficult to retrofit).

## 3.9 Summary of strengths and weaknesses of anti-trash devices

### 3.9.1 Screens

#### For

1. Effective at preventing larger trash from entering the fish pass/inlet
2. Can be cleaned from surface walkway using suitable rakes

#### Against

1. Minimum bar spacing (250 mm) will allow leaves and small twigs to enter
2. Subject to blocking if trash allowed to build up on bars

3. Need regular and frequent manual clearance during significant parts of the year
4. Require provision of safe and easy access for clearing

### 3.9.2 Fixed deflectors

#### For

1. Acts as a solid barrier to floating trash
2. If in a suitable location, intercepted trash may be cleared by the river flow
3. Can be attached easily to nearby concrete or brick walling, or attached to posts
4. Can be used to deflect trash into a trap or holding area

#### Against

1. Waterlogged trash will pass under deflector
2. Needs adequate free depth below the bottom edge of the deflector to avoid trash being pulled under by current
3. Risk of deflected floating trash being carried around the open end of a deflector and entering the fish passage or water inlet
4. Not suitable where large changes in river level occur

### 3.9.3 Floating booms

#### For

1. Follows changes in water level in river
2. Vertical (downward) fin fitted along boom reduces the risk of trash being drawn under the boom

#### Against

1. Sliding connections at the boom end may jam on locating posts
2. Trash may be swept under the boom if the current there is too strong
3. If the boom is not located correctly, trash may be swept around the downstream end and enter the fish pass/inlet

## 3.10 Proposals for further work

This study on trash accumulation indicates the need for further work in the following areas:

1. Information on the trash behaviour at a wider selection of flow measurement structures could be obtained through a questionnaire designed for this purpose, and sent to selected Environment Agency staff with responsibility for hydrometry.
2. Research is needed into how best to establish upstream river conditions that would result in trash not passing close to fish pass entrances. The use of fixed bed vanes to impart the optimum secondary circulation in the river

should be explored. The same approach could help in cases where excessive bedload sediment is known to block fish passes.

3. The effectiveness of floating booms in preventing trash ingress could be improved if more were known about the effect of boom length and location in relation to the inlet size and the position of the neighbouring weir crest, or other river-flow structure. Laboratory tests might establish this.
4. Guidelines for the design of screens should be drawn up, including the health and safety aspects of access for cleaning.

## 3.11 Conclusions

This chapter reports a study of trash accumulation at river structures, which had, in summary, the objectives:

- review the methods in use to minimise trash accumulation on in-river structures, including fieldwork and a literature search;
- provide guidance on the design and selection of fish passage aids;
- recommend further desk or laboratory studies required.

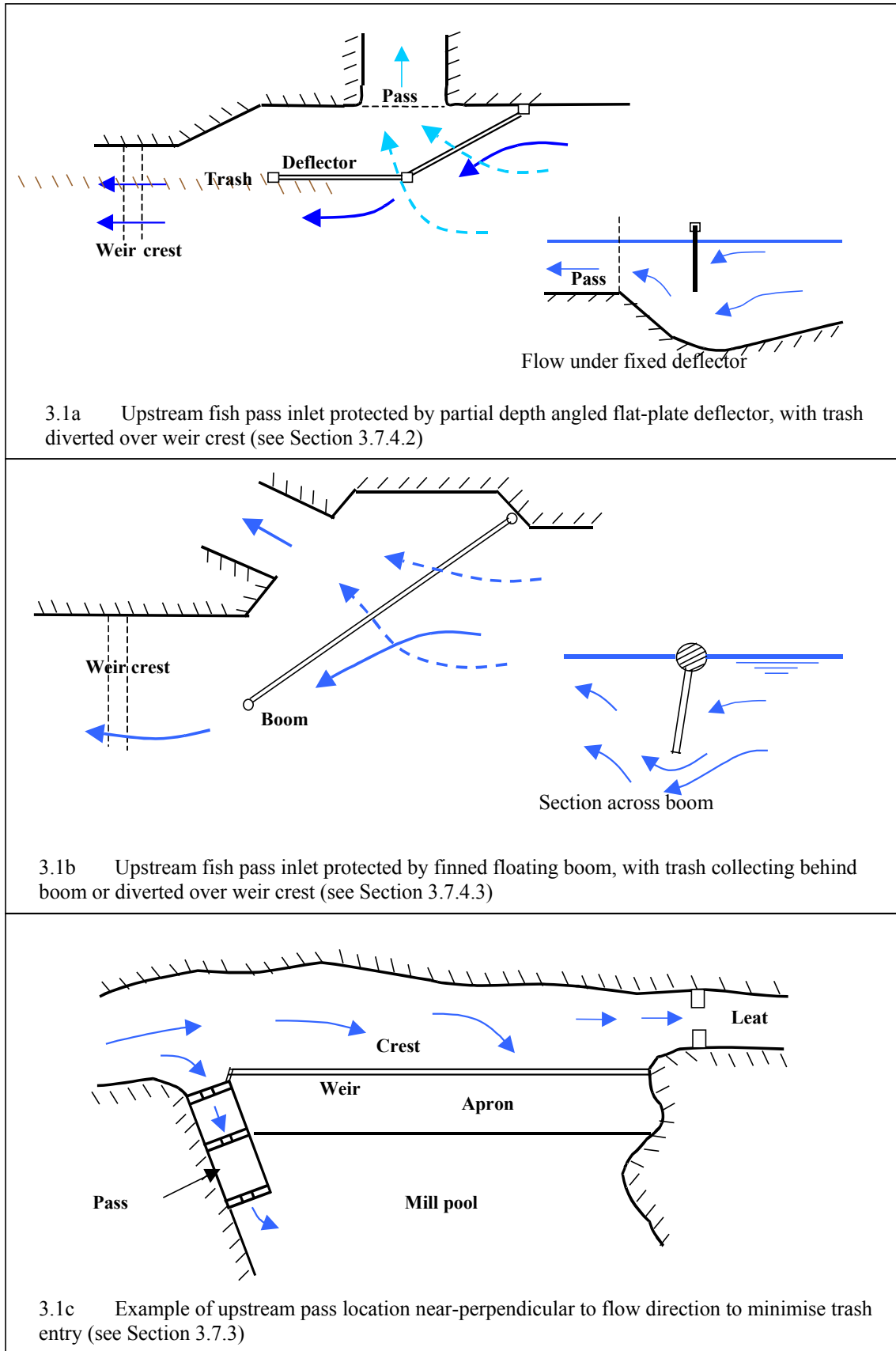
The detailed findings are given in Sections 3.5 to 3.10, but the important general conclusions are:

1. The fieldwork was undertaken in November and December 2003, when trash problems caused by the autumn fall were clearly in evidence.
2. All Environment Agency regions were visited, with the exception of Anglian Region, where fish passage aids are not common.
3. The inspections are thought to have covered between 5 and 10 per cent of the fish passes in England and Wales.
4. The types of fish passes inspected included:
  - pool and traverse
  - side baffle, including Denil
  - easement devices, including 'Hurn'-type baffles
  - bottom baffle, Larinier.
5. The literature search yielded very little useful information on methods to avoid trash problems, but see Section 3.6.
6. Section 3.7 deals with those factors that influence trash retention at fish passage aids. The effectiveness and selection of anti-trash devices are discussed in relation to:
  - screens
  - fixed deflectors
  - floating booms
  - positioning of enclosed fish passes.
7. Section 3.8 deals with those factors that influence trash retention specifically at weirs. Types considered are:
  - flat-V weirs
  - Crump weirs

- horizontal broad-crested weirs
- non-gauging weirs and natural obstructions.

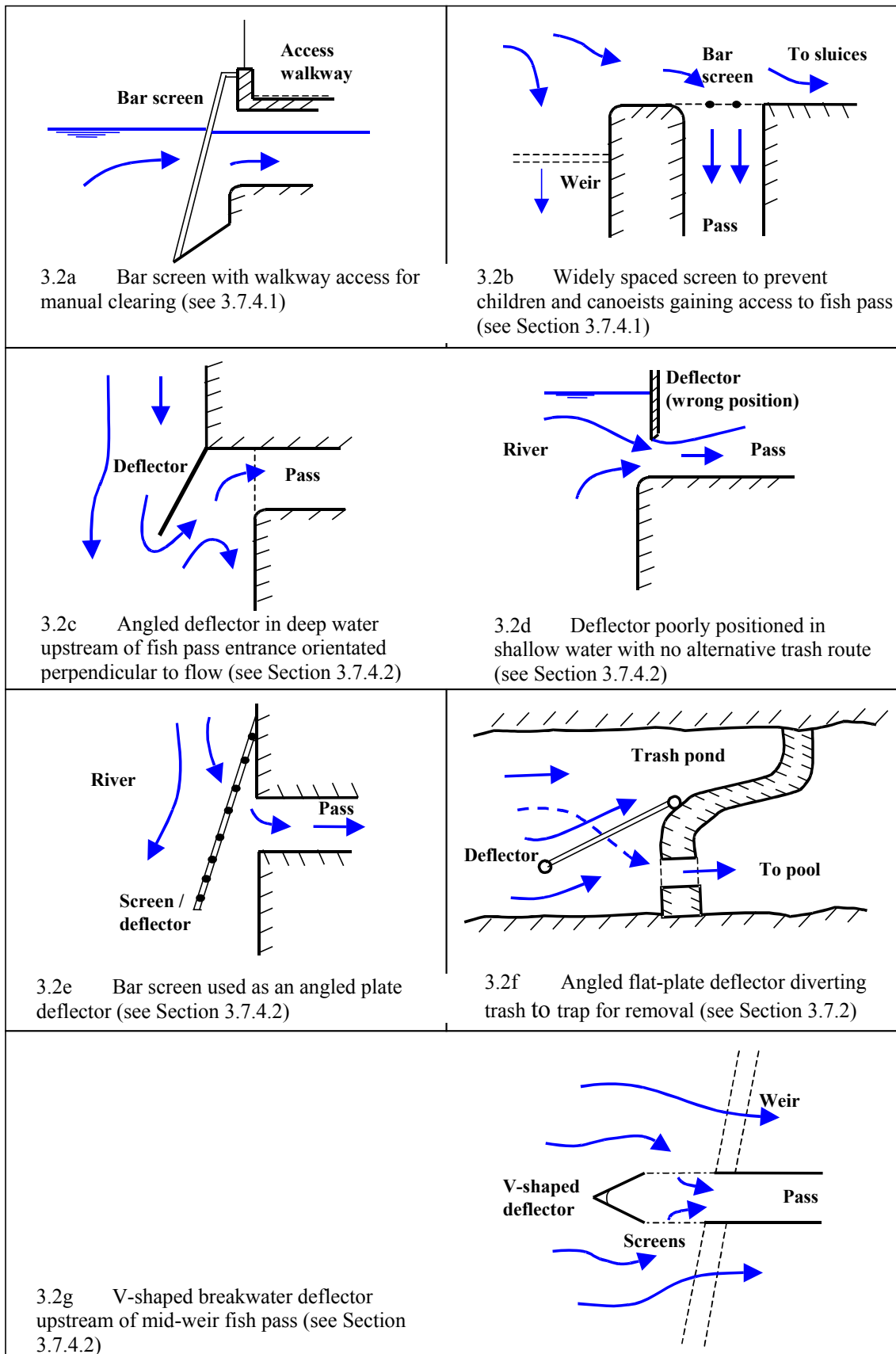
It reflects on the potential value of remote surveillance of sensitive installations to help maintain performance while minimising manpower requirements.

8. The strengths and weaknesses of anti-trash devices are given in Section 3.9. These are listed separately for screens, fixed deflectors and floating booms. While many factors apply to the different types, one common theme is the requirement for regular inspection and maintenance. This is both to ensure that the fish pass remains effective as far as fish migration is concerned, and also to maintain the head–discharge relationship if accurate flow measurement is to be achieved.
9. Section 3.10 identifies suggestions for further work. These, in summary, are:
  - the use of a questionnaire to gain further information on trash problems;
  - research to establish the upstream river conditions best suited to the avoidance of trash close to the fish pass inlet;
  - a study of floating booms to establish design parameters;
  - the development of design guidelines for screens, including health and safety aspects.

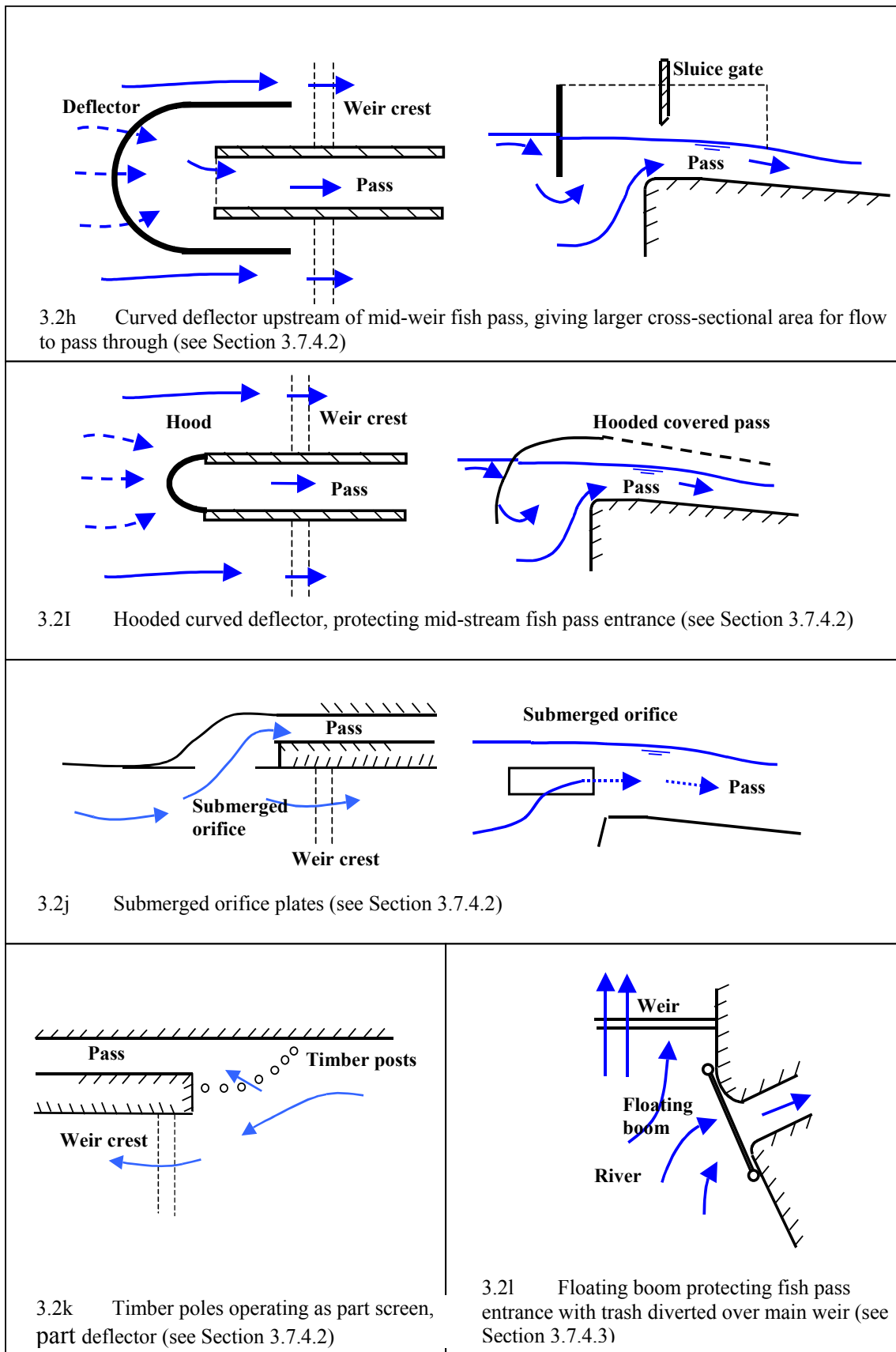


**Figure 3.1 Examples of trash minimisation techniques used at fish pass entrances**



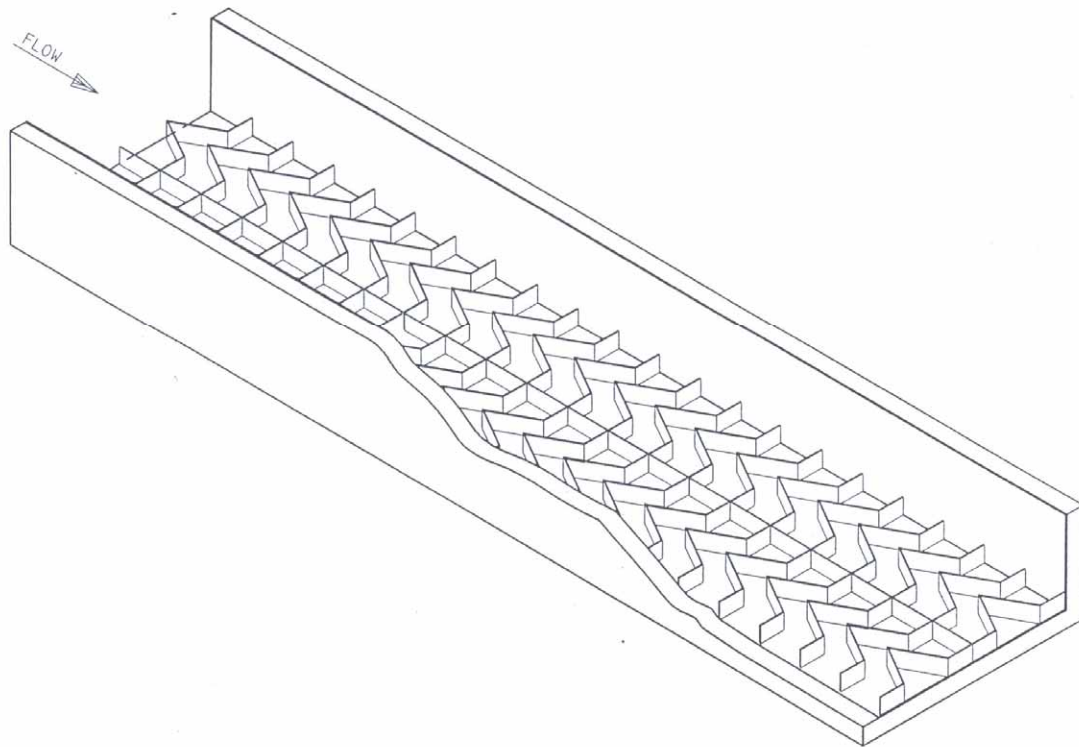


**Figure 3.2 Examples of types of trash deflector**



**Figure 3.2 Examples of types of trash deflector (continued)**

## 4. Laboratory tests to provide an accurate hydrometric calibration of a larinier fish pass (study C)



**Figure 4.1 Larinier fish pass**

### 4.1 Introduction

Graphic stage–discharge curves are available in Vigneux and Larinier (2002) for the Larinier fish pass. Additionally, some calibration work has been done on Larinier fish passes at Fawley (Turnpenny *et al.*, 2002), but the facilities there do not have the precision required by British and International Standards for hydrometric work. As stated earlier in Section 2.4.3 of the Phase 1 Technical Report on the current research project:

*The basic facilities [at Fawley] do not have a constant head tank in the water supply pipework and hence steady flow cannot be guaranteed. The claimed accuracy for flow measurement is  $\pm 1\%$  or better but this is a manufacturer's claim and has not been verified. The overall accuracy is, of course, also influenced by the precision of the dimensions of the model structures and of the upstream head measurement. In these tests head measurements were made with point gauges to a claimed accuracy of  $\pm 1$  mm which compares with  $\pm 0.01$  mm required and previously used for hydrometric work.*

Readers are referred to Section 2.7.1 of this report for further details.

The popularity of Larinier fish passes is increasing and their usage is likely to become widespread in the UK. Thus, there is a need to provide calibration data for hydrometric standards if they are to be considered for flow measurement alone or as part of a combined flow measurement system.

## 4.2 Objectives

The objectives of this study were twofold:

- to provide calibration data and modular limit data for Larinier fish passes;
- to investigate modifications at the upstream end that will improve hydrometric accuracy.

## 4.3 Laboratory installation

The experimental work was carried out in HR Wallingford's General Purpose flume. The water circulation system is designed to ensure constant flow. This is achieved by using a high head centrifugal pump that feeds through a constant head tank to the test section of the flume. Discharge is measured volumetrically to an estimated accuracy of 0.2 per cent and 0.4 per cent at low and high flows, respectively. This is achieved by deflecting the flow leaving the flume to a separate volumetric tank for an accurately measured length of time. Levels in the tank are taken before the flow is deflected to the tank and some time afterwards, when conditions have settled down. Water levels were measured by piezometric tappings set in the side of the flume at weir crest level. These were connected to stilling pots at which micrometer screw gauges, reading to 0.01 mm, were used to record water levels. The tapping positions were 0.5, 1.0, 1.5 and  $2.0h_{max}$  upstream of the transverse section of the first baffle of the Larinier fish pass,  $h_{max}$  being defined by Larinier as 0.42 m prototype. The main flume was narrowed down to 300 mm in width for the current series of experiments on the Larinier fish pass so that sufficient head could be generated with the installed flow capacity available.

Photographs of the flume and the deflector gear for the volumetric tank are given in Appendix F.

## 4.4 The Larinier fish pass

The Larinier fish pass tested was a half-scale model of a super-active type pass with 100 mm baffles. One 600 mm unit was installed in the flume described in Section 4.3. A diagram of the fish pass tested is given in Appendix G.

## 4.5 Analysis of results

### 4.5.1 Modular flow calibration

#### Discharge equations

A suitable modular flow equation for the Larinier fish pass, as described in Section 2.7.1, is:

$$Q = b C_{de} (g)^{0.5} (H_{1e})^{1.5} \quad (4.1)$$

where

$$H_{1e} = H_1 - k_h = h_1 + (v_1)^2/2g - k_h \quad (4.2)$$

where

$b$  = crest breadth (m) measured at transverse section of upstream baffle

$C_{de}$  = dimensionless coefficient of discharge

$g$  = acceleration (m/s<sup>2</sup>) due to gravity

$h_1$  = upstream gauged head (m) relative to transverse section of upstream Larinier baffle

$H_1$  = upstream total head (m) relative to transverse section of upstream Larinier baffle

$H_{1e}$  = effective upstream total head (m) relative to transverse section of upstream Larinier baffle

$k_h$  = head correction factor (m) taking into account fluid property effects

$Q$  = flow (m<sup>3</sup>/s)

$v_1$  = velocity (m/s) of approach at tapping location

For a simple two-dimensional weir it is normally possible to derive the value of  $k_h$  by considering the experimental results at very low heads, say less than 0.03 m. This was attempted for the Larinier fish pass, but the results remain inconclusive because of the very complex changing flow conditions under these circumstances. A realistic value of  $k_h = 0$  was chosen, this being midway between the small positive value appropriate to Crump weirs and the small negative value appropriate to thin plate weirs.

#### Method

Individual coefficient values were derived as follows:

1. With the installation dry, the breadth of the Larinier fish pass at the location of the transverse section of the upstream baffle was measured at several positions in the vertical. The mean crest breadth,  $b$ , was then determined.
2. The bed level, at the location of each of a range of four upstream head gauges, was measured relative to the level of the transverse section of the upstream baffle.
3. A particular discharge was set and allowed to settle for 2 hours before  $h_1$  and  $Q$  were measured.

4. The mean velocity,  $v_1$ , at the location of each of the four upstream head gauges was determined from the measured flow,  $Q$ , and area of flow at the gauge location.
5.  $H_{1e}$  was computed from Equation (4.2), taking a value for  $k_h$  of 0.0000 m.
6.  $C_{de}$  values were then computed from Equation (4.1).

The above procedure was carried out over the full range of flows and  $C_{de}$  was plotted against  $h_1$  – one curve for each location at which the upstream head (stage) was measured.

### Results and conclusions

The tests were carried out on a half-scale model of the Larinier fish pass, but for clarity and ease of use the results are presented in prototype dimensions.

The basic calibration results are shown in *Figure 4.2* (the  $h_{max}$  in *Figure 4.2* refers to the maximum head recorded in the current tests, 0.6 m).

To interpret *Figure 4.2* it is necessary to appreciate how flow patterns through a Larinier fish pass change with flow. When a Larinier fish pass first spills it does so over the transverse section of the most upstream baffle. As the flow increases, the ‘herring bone’ section of the upstream baffle is progressively over-topped until, at a head of 45 mm, flow is taking place over all sections of the upstream baffle (and similar flow conditions are occurring at all the other baffles). At this stage the flow is highly three dimensional. As the flow continues to increase, the flow pattern becomes progressively more two-dimensional (forward and vertical motions only) until, at a head of around 200 mm, the flow pattern settles to a quasi two-dimensional state in which the baffles could be regarded as bed roughness elements rather than ‘weirs’ in their own right.

*Note.* The Environment Agency tries to design fish passes to operate at heads greater than 0.2 m, when suitable pass hydraulics commence. This is based upon Larinier’s recommendation.

These three phases are shown very clearly in *Figure 4.2*. The rising coefficient value up to a head of around 70 mm represents the range in which the flow conditions are highly three-dimensional and the crest length is changing with flow. The coefficient value rises because the effective crest length and flow directions change as the flow changes. The falling coefficient value from a head of around 70 mm to around 250 mm is the range in which the flows become progressively more two-dimensional. Finally, the constant coefficient above a head of 250 mm is the quasi two-dimensional phase.

Larinier calibration ( $k_h = 0.0000$  m)

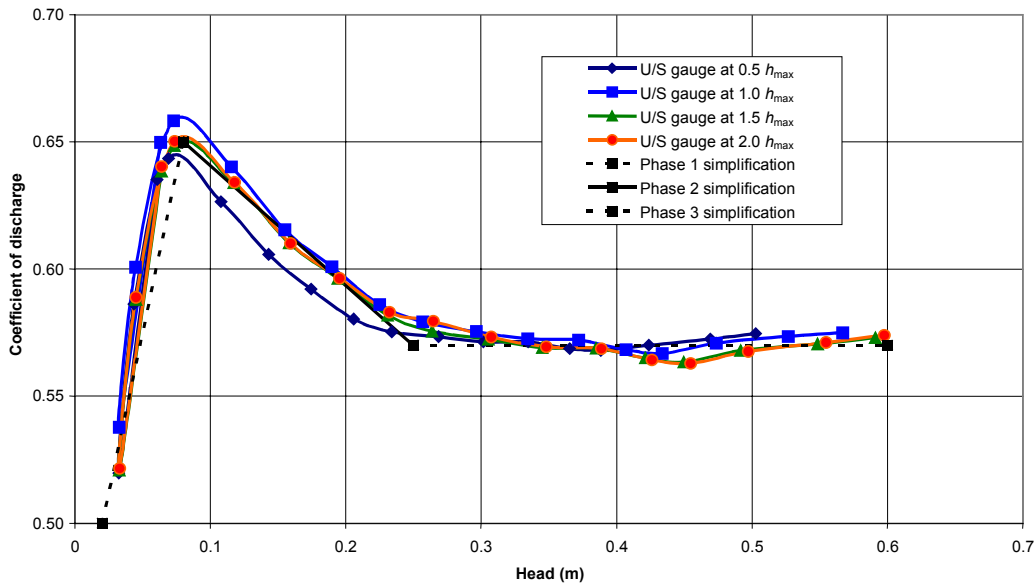


Figure 4.2 Larinier calibration ( $k_h = 0$ )

Figure 4.2 shows the results for the four head measurement locations. We recommend the use of the gauge at  $2.0h_{max}$  upstream of the crest, which is also the recommendation of many types of gauging structures.

Table 4.1 gives the raw data for the coefficients given in Figure 4.2 ( $2.0h_{max}$  head measurement).

Table 4.1 Raw coefficient data

Head (m)	0.033	0.045	0.064	0.073	0.118	0.159	0.195	0.232	0.265
Coeff.	0.522	0.589	0.640	0.650	0.634	0.610	0.596	0.583	0.580
Head (m)	0.307	0.348	0.389	0.426	0.455	0.497	0.555	0.598	
Coeff.	0.573	0.569	0.569	0.564	0.563	0.568	0.571	0.574	

For computational purposes we recommend that following values of  $C_{de}$  be used in Equation (4.1):

$$\begin{aligned} &\text{Phase 1 (} 0.02 \text{ m} < h < 0.08 \text{ m)} \\ &C_{de} = 0.50 + 2.50 (h - 0.02) \end{aligned} \tag{4.3}$$

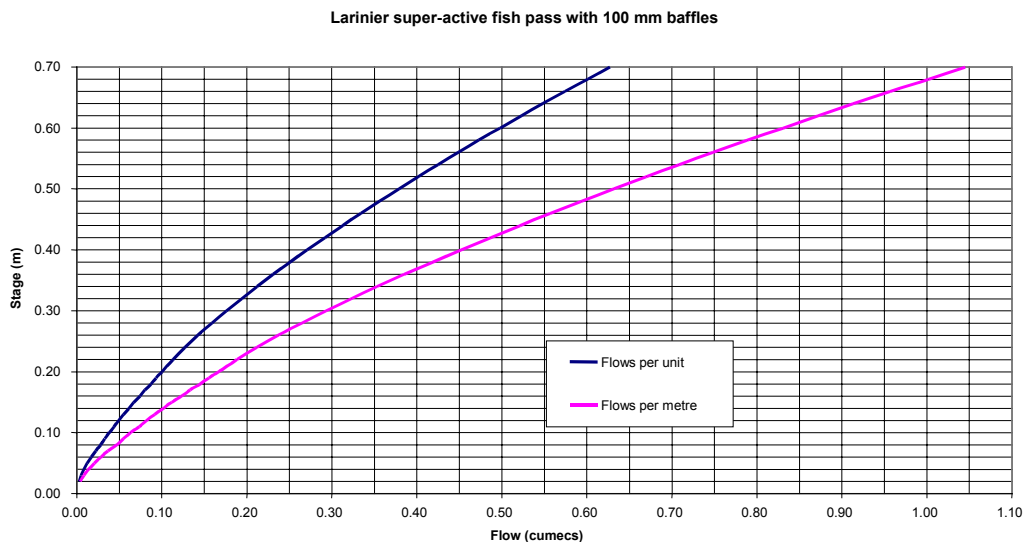
$$\begin{aligned} &\text{Phase 2 (} 0.08 \text{ m} < h < 0.25 \text{ m)} \\ &C_{de} = 0.65 - 0.47 (h - 0.08) \end{aligned} \tag{4.4}$$

$$\begin{aligned} &\text{Phase 3 (} h > 0.25 \text{ m)} \\ &C_{de} = 0.57 \end{aligned} \tag{4.5}$$

The value of  $k_h$  used in Equation (4.2) should be 0.

Using the above coefficient values the calibration of a Larinier super-active fish pass with 100 mm baffles is shown graphically in *Figure 4.3*.

*Note.* The stage is related to the crest level of the transverse section of the upstream baffle and the data relate to a head (stage) measurement 1.m, upstream of the transverse section of the upstream baffle.



**Figure 4.3** Flow data for the Larinier super-active fish pass with 100 mm baffles

Numerical values used to build *Figure 4.3* are given in Appendix H. Photographs, showing flow patterns, are given in Appendix I.

#### 4.5.2 Modular limit

The modular limit of a gauging structure is an important factor because it determines how easily the structure drowns. A thin plate weir, for example, starts to drown as soon as the downstream water level reaches crest level. On the other hand, a Crump weir does not start to drown until the downstream total head reaches 75 per cent of the upstream total head. Under these conditions, downstream water levels are normally well above crest level. The latter type of weir is therefore far less susceptible to downstream effects.

The modular limit of the Larinier fish pass was evaluated using the same half-scale model as for the modular flow tests. The procedure was to set a particular discharge and to carry out tests with a series of increasing tailwater levels. The initial tailwater level was sufficiently low to ensure modular flow, and the increments by which tailwater levels were raised were chosen such that flow conditions would become drowned in the latter stages. These test series were carried out at three specific modular heads (flows) to evaluate any



changes in the modular limit with flow. The nominal heads chosen were 0.2 m, 0.4 m and 0.6 m, these covering the operational range of the fish pass.

The drowned flow over the Larinier fish pass may be described by the equation:

$$Q = b C_{de} f (g)^{0.5} (H_{1e})^{1.5} \tag{4.6}$$

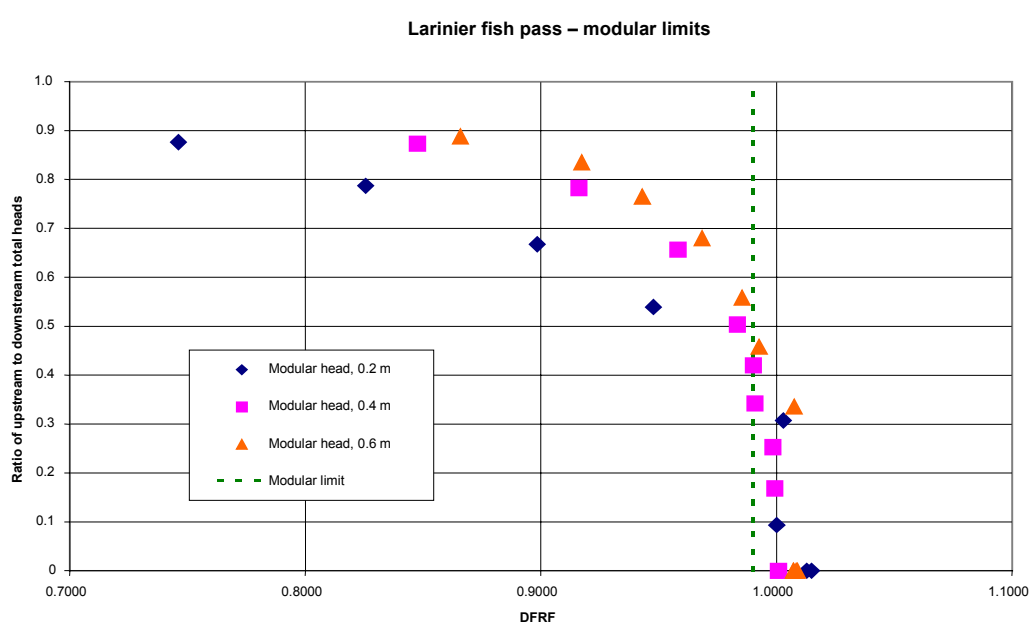
where  
 $f$  = drowned flow reduction factor  
 See notation for previously used symbols.

Re-arranging Equation (4.6), the DFRF,  $f$ , can be expressed as:

$$f = Q/[b C_{de} (g)^{0.5} (H_{1e})^{1.5}] \tag{4.7}$$

All parameters, with the exception of  $C_{de}$ , were measured or known in each test. The appropriate value of  $C_{de}$  was taken from *Figure 4.2* for the particular head observed in each test. This information enabled us to compute the value of  $f$  for each test case. The results are shown in *Figure 4.4*, in which the DFRF,  $f$ , is plotted against the ratio of upstream to downstream total heads,  $H_2/H_1$ . There are three curves, each one relating to a particular value of flow (modular head).

The curves reach modular flow conditions ( $f = 1.0$ ) asymptotically and hence it has always been customary to define the modular limit as the condition when the flow is reduced from the equivalent modular flow by 1 per cent (i.e.,  $f = 0.99$ ). This condition is indicated in *Figure 4.4*.



**Figure 4.4 Modular limits for the Larinier fish pass**

From a flow gauging aspect, the Larinier fish pass is a mixture between a thin plate weir (the baffles) and a triangular profile weir (the longitudinal profile of the fish pass). Thin plate weirs have very low modular limits (0 per cent) and triangular profile Crump weirs have relatively high modular limits (75 per cent). The results for the Larinier fish pass fit logically between these values, with the modular limit tending to reduce at low heads, when the baffles become more dominant, and to increase at high heads, when the general triangular profile of the fish pass dominates. The observed modular limits in terms of  $H_2/H_1$  are in the range from 35 per cent at low heads to 55 per cent at high heads.

The modular limit (ML) of the Larinier fish pass may be defined approximately by the expression:

$$ML = (20 + 60h_1) \text{ per cent} \quad (4.8)$$

### 4.5.3 Conclusions

1. A calibration of the Larinier fish pass with 100 mm baffles has been determined, with the accuracy required by British and International Standards, up to a head of 0.6 m. Flow conditions up to this head are judged by the Project Board to be satisfactory for fish migration.
2. The hydrometric range of the fish pass has been extended from 0.18-0.42 m to 0.18-0.60 m for salmonids. Flows per Larinier unit from 0.09 m<sup>3</sup>/s to 0.50 m<sup>3</sup>/s are now permissible, compared with the earlier recommendation of 0.09 m<sup>3</sup>/s to 0.29 m<sup>3</sup>/s. Corresponding flows per metre width are from 0.15 m<sup>3</sup>/s to 0.83 m<sup>3</sup>/s and from 0.15 m<sup>3</sup>/s to 0.49 m<sup>3</sup>/s. For coarse fish, the hydrometric range remains from 0.09 m<sup>3</sup>/s to 0.29 m<sup>3</sup>/s, with corresponding flows per metre width of 0.15 m<sup>3</sup>/s to 0.49 m<sup>3</sup>/s.
3. The coefficient of discharge in the modular flow range varies with stage. The relationship can be approximated in three distinct head ranges by linear equations. Particular care will be needed if the Larinier fish pass is to be used for flow gauging, and the processing software will need to take into account variable coefficient values.
4. Variations in coefficient values are most significant at low flows, when flow conditions within the fish pass are particularly complex. The measurement of extreme low flows using the Larinier fish pass is not recommended unless a head of more than 0.2 m can be maintained at the fish pass. This situation will arise where the fish pass is set below the level of the lowest weir crest and all flows are taken by the fish pass.
5. The modular limit for the Larinier fish pass is lower than that of a triangular profile Crump weir, but higher than that of a thin plate weir. The modular flow range of the Larinier fish pass is less than that of a Crump or flat-V weir, and the fish pass will be more prone to drowning when placed in a gauging structure–fish pass combination. This is a major disadvantage from the hydrometric point of view. However, this can be overcome by raising the whole gauging structure–fish pass combination, which then provides better flow measurement (in that the modular flow range is extended) and also provides acceptable flow conditions within the fish

pass. The downside may be considerations of cost, environmental factors other than fish passage and increased upstream water levels.

6. The variable coefficient of discharge in the modular flow range and the relatively low modular limit provide a strong incentive to adapt the upstream end of the fish pass to incorporate a more conventional flow gauge (see Section 4.6).
7. The calibration derived in the laboratory only applies to prototype Larinier fish passes if they are manufactured, installed and maintained to a high standard. The first three baffles are particularly important in terms of the hydrometric calibration.
8. If the Larinier fish pass is manufactured, installed and maintained to a high standard, the accuracy of its modular flow calibration is comparable with any of the gauging structures that currently appear in standards. The uncertainty, at 95 per cent confidence levels, in its coefficient of discharge is around 2 per cent, assuming software is developed to cope with the varying coefficient at low heads. However, the modular limit of the Larinier fish pass is significantly lower than that of a Crump or flat-V weir. This restricts the range of flows over which the modular flow calibration will apply at any particular installation. Calibration of the Larinier fish pass in the drowned flow range is not recommended because a unique drowned flow relationship will certainly not exist for a device that generates such complex flow conditions.
9. For this particular type of fish pass data are now available that would enable the fish pass to be used as a flow measurement device with comparable accuracy to a conventional weir, with the following important provisos:
  - The physical dimensions of the fish pass are important and the fish pass needs to be manufactured and installed with precision. The dimensional aspects of the first few baffles are of vital importance, as is their precise elevation.
  - The fish pass needs to be well maintained to avoid any sort of blockage (see Chapter 3).
  - The fish pass, which forms an additional flow path, is subject to 'transfer' uncertainties if there is no direct head measurement at the fish pass.
  - The flow processing software needs to be able to cope with a coefficient value that varies with head.

*Note.* Tests have been undertaken, as described later in this chapter, that would enable a standard Crump weir to be placed immediately upstream of a Larinier fish pass. The first three items above would still need to be addressed, but the fourth would no longer be a problem.

## 4.6 Flow gauging adaptation at the head of a Larinier fish pass

### 4.6.1 Introduction

It has been shown that the Larinier fish pass has some shortcomings in terms of its use as a flow gauging structure. If the shortcomings are not acceptable, they could potentially be overcome if a carefully designed gauging structure were to be placed upstream of the fish pass. However, hydraulic testing of this arrangement was considered important to look at flow patterns and to evaluate the implications of these in terms of the ability of fish to negotiate the fish pass and the gauging structure sequentially.

The important factors in terms of maintaining the ability of fish to migrate through the system are:

1. the gauging structure must be set at a level not much higher than the head of the fish pass to minimise the magnitude of this additional 'hurdle' as far as fish are concerned;
2. the gauging structure must be high enough to ensure that modular flow conditions, and hence gauging accuracy, are maintained up to a defined flow rate;
3. the area between the fish pass and the gauging weir – the intermediate pool – must provide an area of relatively low velocity and turbulence in which fish can rest before negotiating the gauging weir.

The third factor requires that the hydraulic jump that forms downstream of the gauging weir should not enter the 'resting' area, but should sit on the downstream face of the gauging structure throughout the design flow range. This is best achieved using a triangular profile Crump weir with its gradually sloping downstream face. To meet all three factors the crest breadth of the gauging weir must be the same as, or very similar to, the width of the fish pass such that the head–discharge relationship of the gauging weir is similar to that of the fish pass. This means that where there are several Larinier units side by side the Crump weir should be a single unit with a crest breadth equal to the combined width of the Larinier units.

In formulating the arrangement to be hydraulically tested in the HR Wallingford facility, the design flow range chosen was the (extended) range of the Larinier fish pass (i.e., the arrangement was to perform satisfactorily up to a head on the fish pass of 0.6 m, rather than the 0.42 m quoted by Larinier). The height of the crest of the Crump weir above the head of the fish pass was chosen such that the gauging weir would reach its modular limit when the head on the Larinier reached 0.6 m (i.e., it would remain modular throughout the design flow range).

Critical dimensions are given in *Table 4.2*. These are prototype values based upon the half-scale model.

**Table 4.2 Critical dimensions of the fish pass–gauging structure arrangement**

<i>Parameter</i>	<i>Dimension</i>
Distance from the apex of the base of the Larinier fish pass to the crest of the Crump weir (to provide adequate dimensions for the intermediate pool)	4.5 m
Truncation of the downstream face of the Crump weir from the crest line (approx. $2h_{\max}$ and in line with standard specifications)	1.0 m
Height of the crest of the Crump weir above the apex of the base of the Larinier fish pass (to maintain modular flow over the gauging structure)	200 mm
Height of the crest of the Crump weir above the crest of the horizontal section of the upstream baffle of the Larinier fish pass	Approx. 155 mm
Depth of the intermediate pool relative to the apex of the base of the Larinier fish pass (to maintain relatively low velocities in the intermediate pool)	475 mm (minimum)
Crest breadth of the Crump weir and width of the Larinier fish pass (to provide similar stage–discharge curves for the gauging structure and the fish pass)	600 mm

The arrangement is shown in *Figure 4.5*.

*Note.* Larinier fish passes may be mounted side by side without divide piers. The results obtained in the current test facility could equally well be applied to two Larinier units with a 1.2 m Crump weir upstream, three Larinier units with a 1.8 m Crump weir upstream, etc.

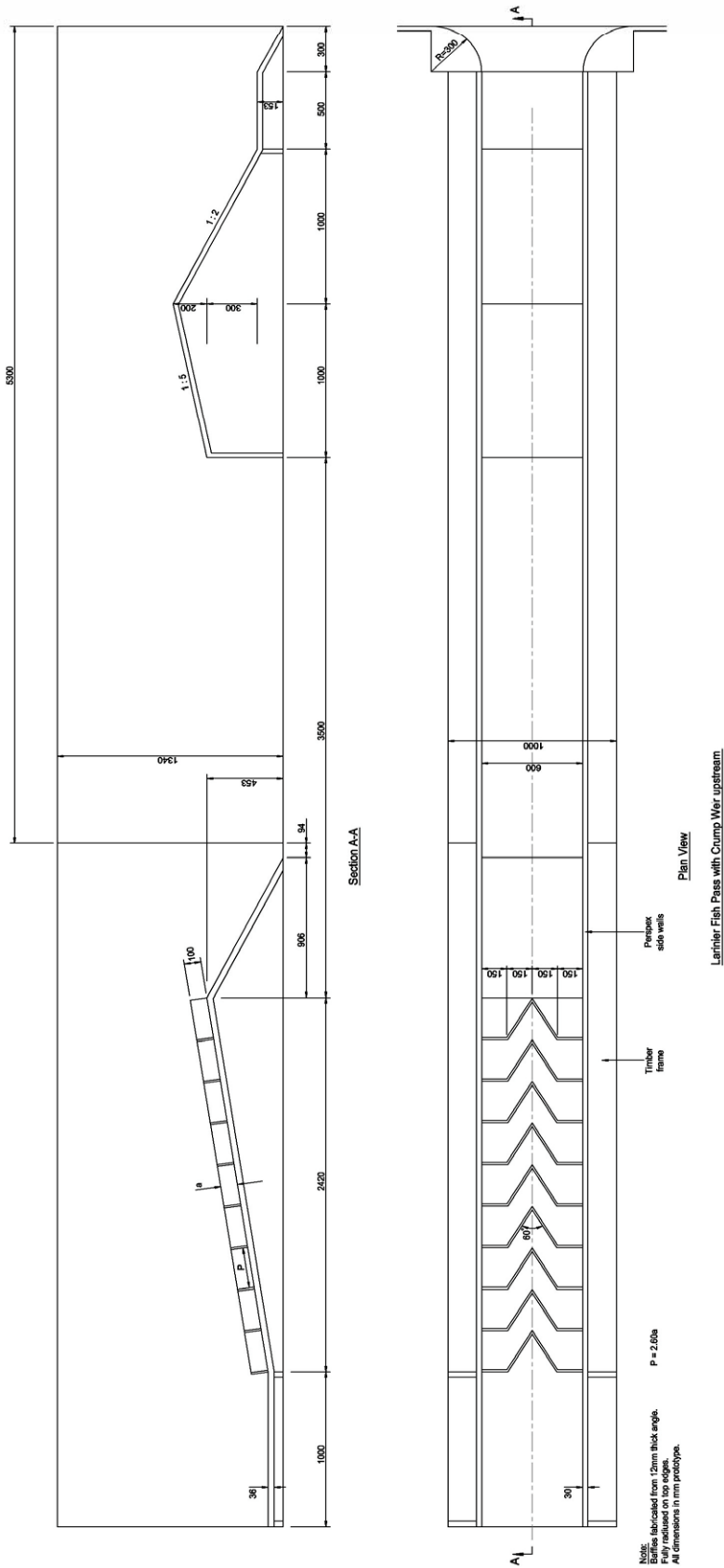


Figure 4.5 Larinier fish pass–Crump weir arrangement

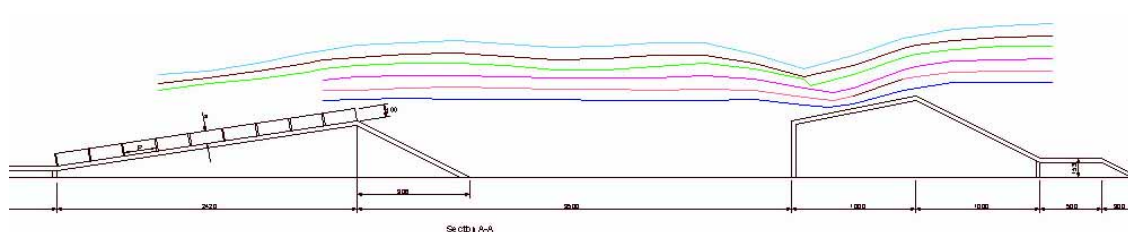
## 4.6.2 Results of the hydraulic testing

The fish pass–gauging structure arrangement was tested at six different flow rates. These corresponded to nominal heads on the Larinier fish pass, ranging from 0.1 m to 0.6 m. At each flow rate the water surface profile was measured. In addition, velocities were measured at six cross-sections between the apex of the base of the Larinier fish pass and the crest of the Crump weir. Up to six velocity measurements were made in each cross-section, depending on local depths.

*Note.* These tests were designed to evaluate flow conditions through the arrangement, not to provide calibration data, which is already widely available for the Crump weir.

### Water surface profiles

The water surface profiles are shown in *Figure 4.6*.



**Figure 4.6** Water surface profiles

Flow conditions through the fish pass–gauging structure arrangement are seen to be satisfactory throughout the flow range. The hydraulic jump is formed just upstream of the truncation point on the downstream face of the Crump weir and its position changes little with flow rate. The intermediate pool is maintained throughout the flow range and the high velocity conditions on the downstream face of the Crump weir extend a distance of no more than 0.8 m.

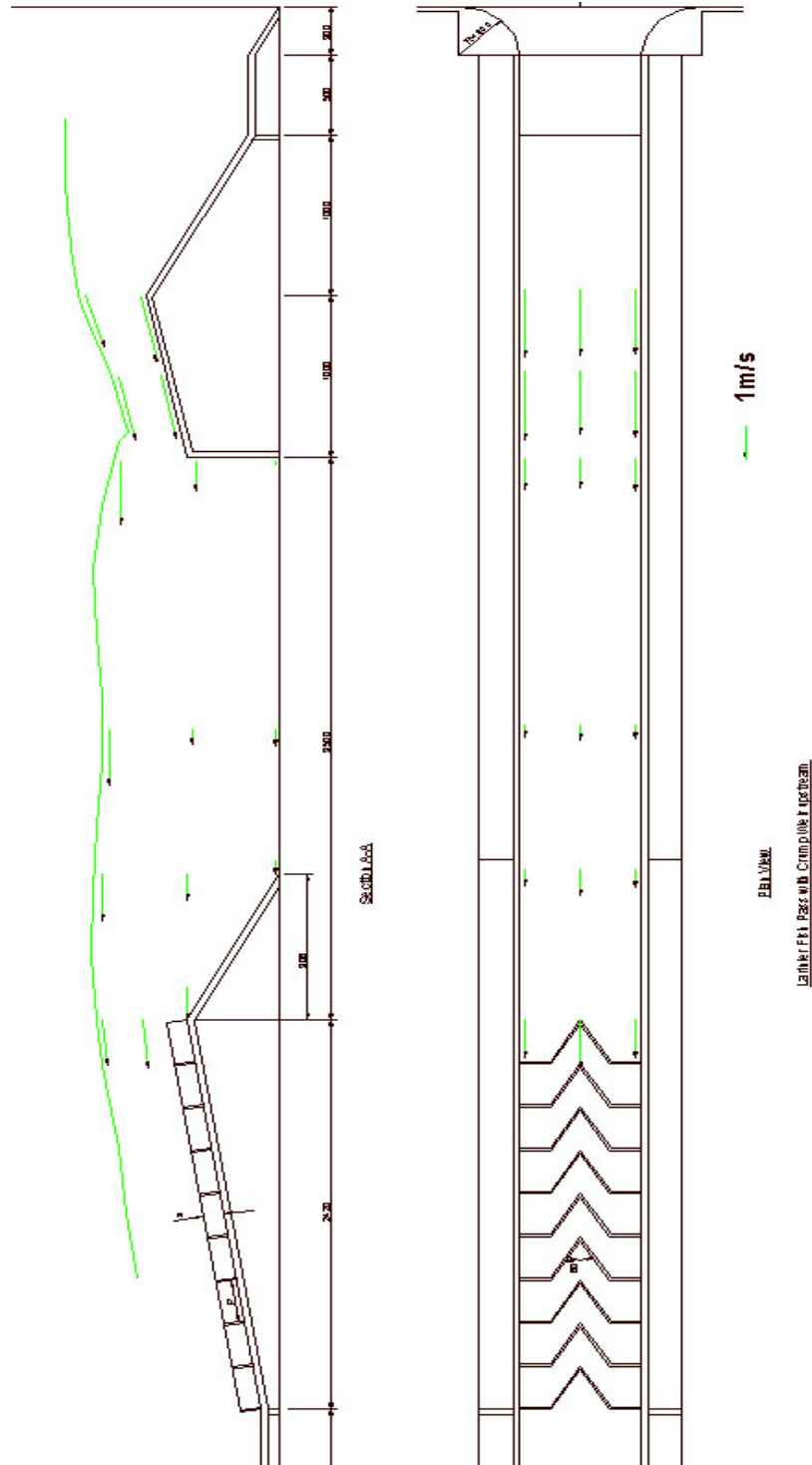
### Velocities of flow

*Mean velocities* in the pool can be calculated from the calibration data for the Larinier fish pass and the depth and breadth of the pool. These mean velocities are summarised in *Table 4.3*.

**Table 4.3** Mean velocities in the pool

Nominal head on Larinier fish pass (m)	Flow per unit width ( $m^2/s$ )	Mean velocity in the pool (m/s)
0.1	0.063	0.11
0.2	0.167	0.24
0.4	0.452	0.50
0.6	0.830	0.75

Velocities greater than 0.4 m/s are above the 90 percentile sustainable speed for small coarse fish. Environment Agency guidelines recommend approach velocities to gauging structures of no more than 0.3 m/s for coarse fish and 0.7 m/s for salmonids.



**Figure 4.7 Point velocities with a head on the Lariner fish pass of 0.4 m (nom.)**



*Point velocities* were measured at several locations and are discussed in the following paragraphs. The complete set of point velocity measurements is shown graphically in Appendix J and a selection of photographs are given in Appendix K.

As an example, the results at one particular flow rate are given in *Figure 4.7*. The flow conditions correspond to a head on the Larinier fish pass of approximately 0.4 m, the upper limit for satisfactory flow conditions as defined by Larinier. The point velocities are shown in *Figure 4.7* together with a scale that relates the length of the velocity arrows to velocity (in m/s).

*Table 4.4* gives a summary of the salient velocities, as far as fish migration is concerned, over the full range of flows.

**Table 4.4 Summary of velocities through the fish pass–gauging structure arrangement**

<i>Nominal head on the Larinier fish pass (m)</i>	<i>Flow per Larinier unit (m<sup>3</sup>/s)</i>	<i>Average velocity near the surface of the pool (m/s)</i>	<i>Average mid-depth velocity in the pool (m/s)</i>	<i>Average velocity near the bed in the pool (m/s)</i>	<i>Max. velocity on the Crump weir upstream of the hydraulic jump (m/s)</i>
0.1	0.04	0.38	0.12	0.10	1.70
0.2	0.10	0.69	0.24	0.16	1.90
0.3	0.18	1.18	0.34	0.22	1.96
0.4	0.27	1.60	0.59	0.27	2.02
0.5	0.38	1.80	1.09	0.31	2.21
0.6	0.50	1.96	1.30	0.30	2.26

*Note.* Velocities were measured with a miniature, 10 mm diameter propeller meter. These propellers count pulses as the tip of the blade passes the body of the meter and cannot differentiate between forward and backward motion. Intermittent reverse currents were visually observed at the mid-depth position and, more often, at the near bed position. Corrections have therefore been made to the indicated velocities assuming that 5 per cent of the counts were 'reverse' at the mid-depth position, rising to 10 per cent at the near bed position. The modified velocities are those quoted in *Table 4.4*.

The clear picture is one of relatively high velocities in the upper regions of the intermediate pool and relatively low velocities near the bed. This pattern is generated because the hydraulic jump is maintained on the downstream face of the Crump weir and no supercritical jet enters the intermediate pool. Subject to prototype confirmation of fish performance, this arrangement seems satisfactory. (It goes without saying that a deeper pool would further reduce velocities, which may be possible in prototype design.)

Velocities on the downstream face of the Crump weir immediately upstream of the hydraulic jump range from 1.70 m/s to 2.26 m/s as the head on the Larinier goes from 0.1 m to 0.6 m. The distance from the hydraulic jump to the

crest of the weir is fairly constant, at 0.8 m. These velocities are higher than typical coarse fish burst speeds of around 1.5 m/s, but the distance to be negotiated is relatively short.

### 4.6.3 Conclusions

1. The arrangement tested ensured that:
  - the intermediate pool was maintained satisfactorily throughout the extended flow range of the Larinier fish pass;
  - relatively low velocities were maintained in the lower regions of the pool throughout the flow range;
  - the gauging weir presented a relatively modest challenge to migrating fish;
  - modular flow occurred over the gauging weir throughout the extended flow range of the Larinier fish pass.
2. To provide this satisfactory performance in practice, it is important that the critical dimensions given in *Table 4.2* are adhered to and the fish pass is maintained free of damage and trash. The length and depth of the intermediate pool are probably the minimum acceptable values and these should be increased where possible.
3. Velocities in the intermediate pool vary with the discharge and from surface to bed. Mean velocities exceed 0.5 m/s when the nominal head on the Larinier exceeds 0.4 m. At a head of 0.6 m the mean velocity is 0.75 m/s. The current Environment Agency recommendations for approach speeds are 0.3 m/s for coarse fish and 0.7 m/s for salmonids. These figures are below those observed in the current testing.
4. Velocities near the bed of the pool are around 0.27 m/s when the nominal head on the Larinier is 0.4 m, and 0.30 m/s when the head on the Larinier is 0.6 m. These are both within the capabilities of small coarse fish.
5. The mean velocity on the downstream face of the Crump weir immediately upstream of the hydraulic jump is almost constant with depth and rises slowly with discharge. At nominal heads on the Larinier fish pass of 0.2 m, 0.4 m and 0.6 m the mean velocities are 1.9 m/s, 2.0 m/s and 2.3 m/s. These velocities are higher than typical coarse fish burst speeds of around 1.5 m/s, but the distance to be negotiated is relatively short.

# 5. Fundamental requirements for the near-crest arrangements of baffles on the downstream face of a measuring weir (study D)

## 5.1 Introduction

Research on 'Hurn'-type easements in the form of baffles on the downstream face of a triangular profile weir is ongoing, but the concept is judged to have promise because the baffle system can be fitted to existing weirs and the adaptation is relatively inexpensive.

Further laboratory work is being undertaken at Shrivenham (Environment Agency R&D, Low-cost solutions for improving fish passage at Crump-type weirs, W6-077) and fieldwork continues at Hurn (Environment Agency R&D, The Hurn gauging station – baffle effectiveness, W6-085). The laboratory work is mainly concerned with the geometry of the sequence of baffles on the downstream face of the weir. The fieldwork includes an assessment of the effectiveness of the baffles in aiding fish migration.

One important design requirement is to know the minimum acceptable distance from the crest of the weir for the most upstream baffle. Fisheries interests would like this baffle as close as possible to the crest to minimise velocities during the final stages of fish ascent. However, the hydrometric performance of triangular profile weirs is very sensitive to flow conditions close to the crest. A laboratory study was thus undertaken to establish the basic ground rules for the uppermost baffles in the Hurn-type easement arrangement in terms of size and distance from the crest. This chapter describes the tests carried out and the results.

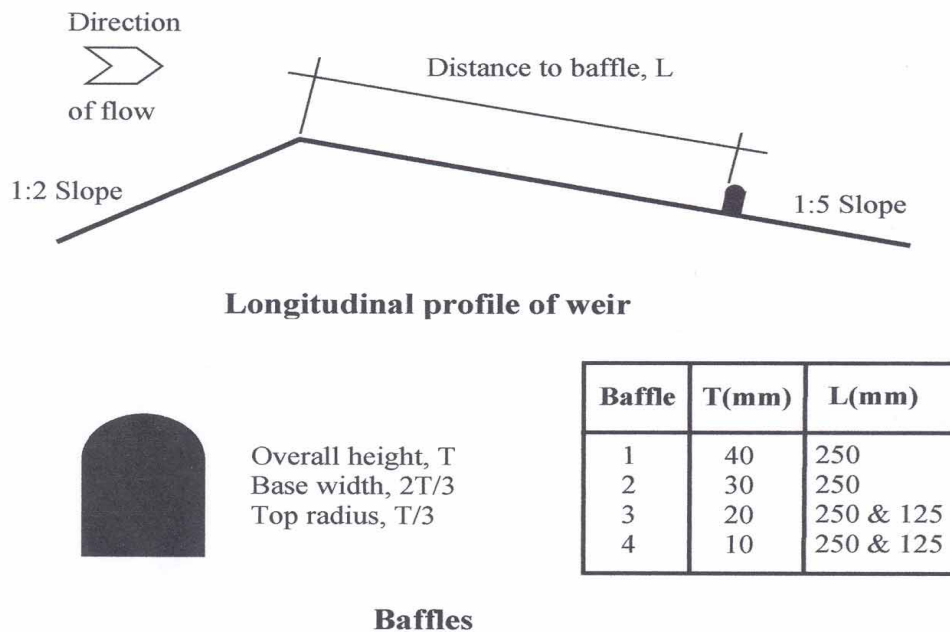
## 5.2 Test arrangements

Tests were carried out on a two-dimensional Crump weir. However, the results and recommendations for particular baffles of particular size are applicable to both Crump and flat-V weirs because the critical location on a flat-V weir is at the lowest crest elevation, where the head is greatest and where the flow conditions are parallel with the channel. The test arrangements are shown in *Figure 5.1*.

As stated above, three inter-related variables need to be considered:

- head over the weir up to which accurate modular flow performance is required,  $H$ ;
- distance from the crest line to the first baffle,  $L$ ;
- size (height) of the first baffle,  $T$ .

In the current tests the shape of the baffles was kept the same, the exact geometry corresponding to those currently in use at Hurn. These baffles have a crest radius one-half the width and one-third the height of the baffle. The size of the baffles and their location relative to the weir crest were varied to cover a range of conditions from no hydrometric interference to significant hydrometric interference. The testing was only concerned with the most upstream baffle as this is the one, if any, that affects the hydrometric calibration. Details of the baffles tested are given in *Figure 5.1*.



**Figure 5.1 Testing arrangements for near-crest baffles**

The Crump weir used for the tests had a crest breadth of 300 mm and a height of 400 mm. However, the test facilities should not be regarded as a specific scale of model. The intention was to provide basic data that could be plotted non-dimensionally and applied to any size of installation from laboratory scale up to large field installations. The testing was done at a scale large enough to avoid significant scale effects. Thus, the results are applicable for any size of baffle.

### 5.3 Testing

The testing involved setting a range of steady discharges over the Crump weir, measuring discharges by volumetric methods and measuring heads using accurate vernier point gauges in stilling wells connected to the approach channel to the weir. The coefficient of discharge of the weir, with and without baffles, was then determined using the standard discharge formula, Equation (2.1).

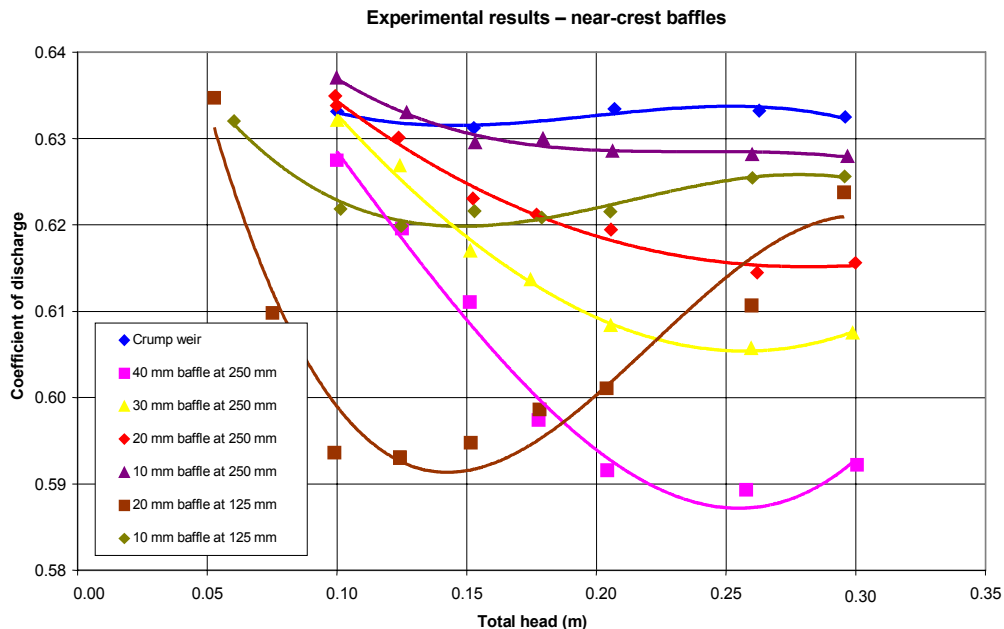
Tests were first carried out without any baffles on the face of the weir, to check that the measured coefficient of discharge corresponded with the standard value. These tests covered the range of heads between 0.05 m and

0.30 m, which would take the separation pocket that forms just downstream of the crest beyond the planned locations for the near-crest baffle. Hence, the baffles would have a greater or lesser hydrometric effect, depending on their size and location.

Baffles 1 to 4 were first tested (sequentially) in the test rig some 250 mm downstream of the crest and modular flow calibrations were carried out up to a head of 0.3 m. Baffles 3 and 4 were then tested closer to the crest at a distance of 125 mm.

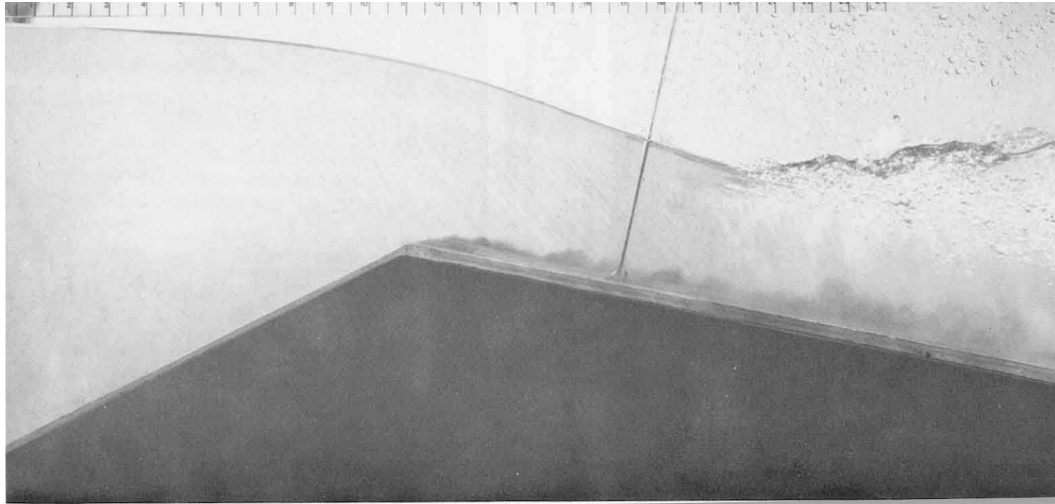
## 5.4 Results

The basic results are shown in *Figure 5.2*, in which the modular coefficient of discharge is plotted against head for the Crump weir alone and the Crump weir with each baffle arrangement.



**Figure 5.2 Experimental results – near-crest baffles**

A separation pocket forms immediately downstream of the crest of triangular profile weirs, both Crump and flat-V (*Figure 5.3*). Flow that travels up the upstream slope of the weir close to the weir surface breaks clear of the surface at the crest apex and describes a near-circular trajectory until it re-attaches to the downstream face of the weir some distance down the downstream slope. The separation pocket varies in size as the head on the weir varies. Its size is proportional to the head. The constant coefficient value for Crump and flat-V weirs is dependent upon the free migration of the separation pocket on the downstream face of the weir.



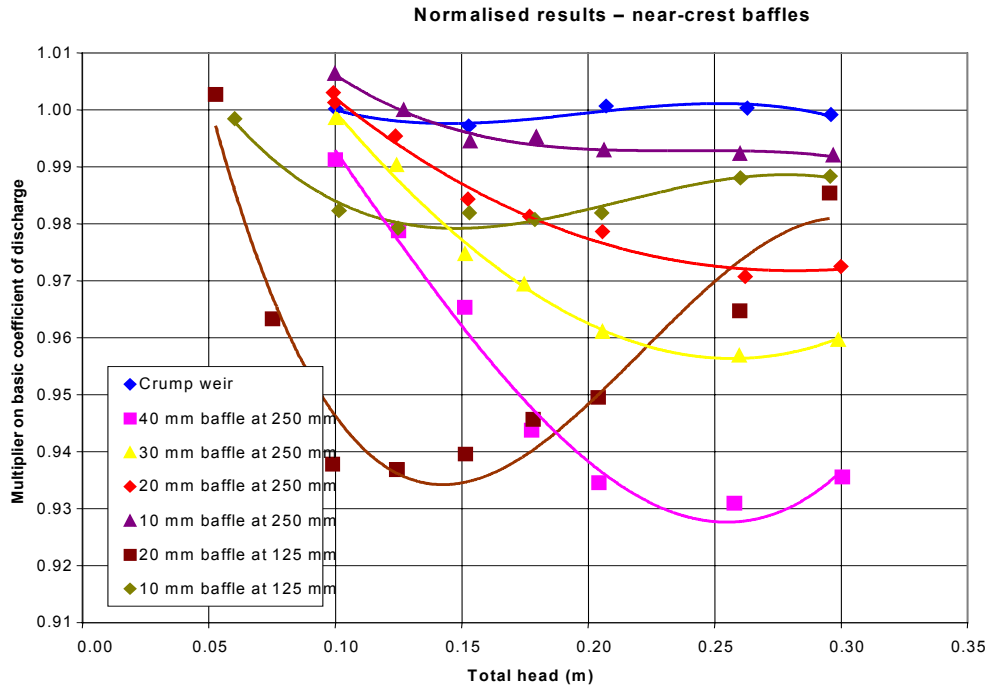
**Figure 5.3 Crump weir showing separation pocket (modular flow)**

Near-crest baffles can interfere with this separation pocket and hence the coefficient of discharge of the weir. It is useful to consider what happens as a particular baffle at a particular distance downstream of the crest is subject to a range of flows. At low flows the separation pocket may be well upstream of the baffle and the baffle has no effect on the coefficient of discharge of the weir. As the flow increases the separation pocket reaches the baffle and starts to be affected by it. The coefficient of discharge will start to fall. A further increase in flow may induce conditions where the baffle is within an enlarged separation pocket, having little effect on the size and shape of the pocket itself. Under these conditions the coefficient of discharge will start to return to normal Crump values.

Coefficient of discharge against head is plotted in *Figure 5.2*, which shows the results for the Crump weir itself, with a mean coefficient value of 0.633, and for each of the tested baffle arrangements. Each baffle arrangement shows a pattern of coefficient values consistent with the description given in the previous paragraph.

### **Normalisation and generalisation of results**

*Figure 5.4* shows the same results, but in a normalised form as a multiplier on the basic coefficient of discharge of the Crump weir. The effect of the baffles tested is to decrease coefficient values by up to 7 per cent under certain conditions.



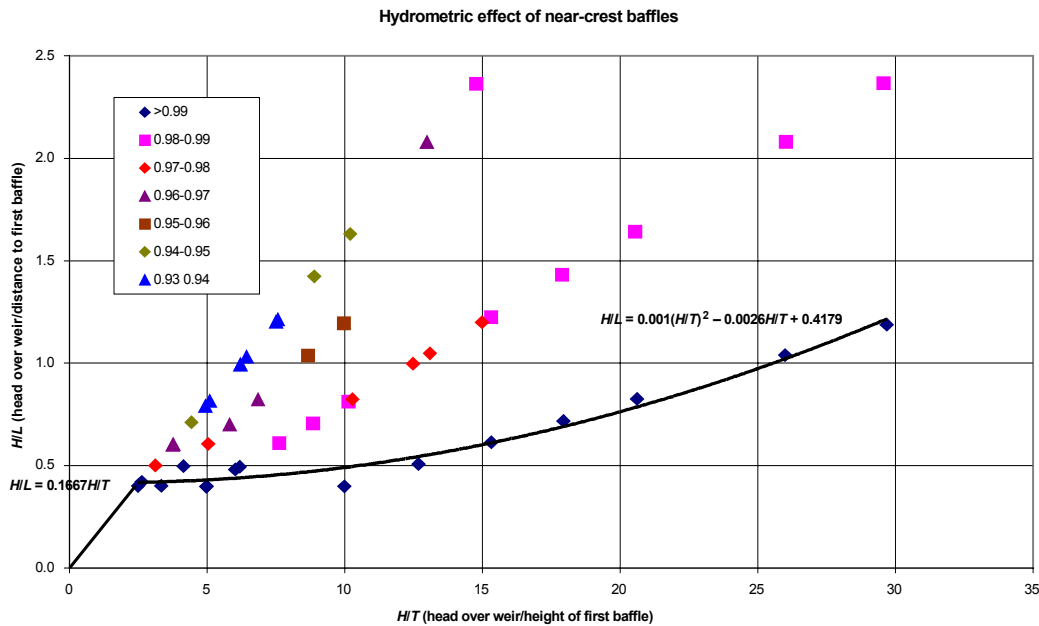
**Figure 5.4 Normalised results – near-crest baffles**

Figure 5.4 indicates those test conditions that are acceptable in terms of baffle size and location, say multipliers in excess of 0.99. It also indicates baffle arrangements that would produce significant changes to the hydrometric performance of the weir. However, the presentation given in Figure 5.4 is not of a general nature, which could be used for design purposes.

As stated above, three inter-related variables need to be considered –  $H$ ,  $L$  and  $T$ . With these three independent variables, all having dimensions of length, the degree to which baffles affect the coefficient of discharge may be presented in terms of the two non-dimensional variables  $H/L$  and  $H/T$ . These relationships, based on the current experimental results, are given in Figure 5.5. There is a good correlation between  $H/T$  and  $H/L$  and the degree to which the baffles affect the coefficient of discharge.

A best fit polynomial curve has been fitted to those results that show a reduction of less than 1 per cent in the coefficient of discharge caused by the existence of a baffle on the downstream face of the weir (Figure 5.5):

$$H/L = 0.001(H/T)^2 - 0.0026H/T + 0.4179 \quad (5.1)$$



**Figure 5.5 Hydrometric effect of near-crest baffles**

At low values of  $H/L$  and  $H/T$  it is possible for the crest level of the baffle to approach the level of the weir crest. These conditions were not tested and are clearly inadmissible because the flow control would transfer from the weir to the baffle. The linear relationship shown in *Figure 5.5* ensures that the crest level of the baffle is always below the crest level of the weir:

$$H/L = 0.1667H/T \quad (5.2)$$

The area beneath the linear and polynomial curves shown in *Figure 5.5* indicates that the baffles affect modular flows by less than 1 per cent, and the curves themselves represent the design limit for baffles.

*Note 1.* The coverage of all the variables was relatively sparse because of time and budgetary constraints. The approach was to cover a range of values of  $H/T$  and  $H/L$  and to determine an envelope curve that would ensure flow measurement accuracy was not significantly affected by the uppermost baffle. The curves that have been produced also include an element of common sense based upon a knowledge of how the separation pocket behaves on a Crump weir. In the modular flow range the downstream end of the separation pocket (where the flow re-attaches to the downstream surface of the weir) is approximately at a distance downstream of the crest equal to the head on the weir. So the minimum distance for any baffle is just greater than the upstream head. This applies to very small baffles that do not significantly affect the flow upstream. However, the larger the baffle the greater their effect on the approach flow. The required distance to the first baffle is the sum of the length of the separation pocket and the length of influence of the uppermost baffle. This means that, for the same head, larger baffles have to be further downstream. An added constraint is that no baffle can be at a level higher than the crest of the weir, which may define the minimum distance when heads are low relative to the height of the baffle.



*Note 2.* It would be possible to use the results given in *Figure 5.5* for greater deviations from the basic Crump coefficient of discharge values. For example, the data could be used to assess the effect of an existing baffle installation where the baffle is clearly too close to the crest. However, the data are relatively sparse and answers would not be precise. Also, the results would only apply to coefficient of discharge values. This could be interpreted in terms of flows on a Crump weir because the separation pocket is uniform across the full width of the weir. The technique would not inform users about changes to flows on flat-V weirs because heads and baffle distances vary across the width of these weirs.

*Note 3.* The testing described in this chapter is concerned with the possible effect of near-crest baffles on modular flows. Baffles on the downstream face of Crump weirs could also affect drowned flows if the baffles cause head losses on the downstream face that are not detected by the downstream gauge. Those weirs with crest tappings would be less prone to this sort of error.

## 5.5 Application of results

The results given in *Figure 5.5* should be used for design purposes as follows:

- choose the design head to which the weir is required to have an accurate modular calibration,  $H$ ;
- choose a size (height) for the baffles,  $T$ ;
- calculate  $H/T$ ;
- Read off  $H/L$  from *Figure 5.5* or use Equation (5.1),  $H/T > 2.4$ , and/or Equation (5.2),  $H/T < 2.4$ , to derive  $H/L$ ;
- calculate the minimum distance for the first baffle,  $L$ .

### Example 1

Calculate the relationship between baffle height and distance downstream of the crest for a Crump weir required to provide a reliable modular flow performance up to a head of 1.0 m. Baffles to be assessed have heights of 0.05 m, 0.10 m, 0.15 m and 0.20 m.

<i>Baffle</i>	<i>Height (m)</i>	<i>H/T</i>	<i>H/L</i>	<i>L (m)</i>
1	0.05	20.000	0.766	1.31
2	0.10	10.000	0.492	2.03
3	0.15	6.666	0.445	2.25
4	0.20	5.000	0.430	2.33

### Example 2

Calculate the relationship between baffle height and distance downstream of the crest for a Crump weir required to provide a reliable modular flow performance up to a head of 0.5 m. Baffles to be assessed have heights of 0.05 m, 0.10 m, 0.15 m and 0.20 m.

Baffle	Height (m)	H/T	H/L	L (m)
1	0.05	10.000	0.492	1.02
2	0.10	5.000	0.430	1.16
3	0.15	3.333	0.420	1.19
4	0.20	2.500	0.418	1.20

## 5.6 Conclusions

This chapter describes an investigation into the effect of near-crest baffles on the coefficient of discharge of a triangular profile Crump weir.

Conclusions are as follows:

1. The results apply to Crump weirs and centre-line conditions on flat-V weirs.
2. The test conditions used in this investigation are defined in *Figure 5.1* and covered a range of baffle sizes and locations. All baffles had the shape of those currently in use at Hurn.
3. The effects of near-crest baffles are dependent upon the:
  - head over the weir up to which accurate modular flow performance is required,  $H$ ;
  - distance from the crest line to the first baffle,  $L$ ;
  - size (height) of the first baffle,  $T$ .
4. *Figure 5.2* shows the basic test results, which indicate deviations of up to 7 per cent from the basic coefficient of discharge of a Crump weir. *Figure 5.4* presents the basic test results in normalised form.
5. A non-dimensional design chart is given in *Figure 5.5*. This defines those conditions that have little or no effect, taken as conditions which exhibit less than 1 per cent reduction from the basic Crump weir coefficient of discharge. In effect, it allows a position to be determined for a baffle that does not interfere significantly with flow gauging. It also provides an approximate method to determine the magnitude of the effect of any baffles that do not meet the 'no effect' criterion.
6. Examples of the use of the design chart given in *Figure 5.5* are presented in Section 5.5.

## 6. Laboratory testing of a larinier fish pass with a submerged orifice upstream intake set alongside a non-specific flow measurement structure (study E)

### 6.1 Objectives

One of the planned outputs from this research is to provide a first draft of a standard for combined fish pass–gauging structure installations. The general arrangement testing described in this chapter was undertaken to confirm suitable design parameters to provide satisfactory gauging structure and fish pass performance. The detailed objectives were:

- To provide guidance on the design of fish pass–gauging structure combinations, which are incorporated in Appendix M of this Final Report (in the form of a first draft standard on fish pass–gauging structure combinations). In setting up the test facility, advice on the requirements of the fisheries and hydrometric interests was sought and taken into account and hence the testing either (a) confirmed the validity of the concepts or (b) indicated minor modifications that were required. In particular the testing provided information on:
  - flow conditions at the upstream entry to the fish pass;
  - flow conditions at the downstream exit from the fish pass;
  - flow conditions within the fish pass;
  - flow conditions within the stilling basin of the measuring weir.
- To consider variations to the design. The variations tested in the design of the fish pass–gauging structure combination included two levels for the fish pass compared with the level of the gauging structure. In the first case (Series A), the fish pass crest was set at weir crest level. In the second case, the fish pass crest was set 0.18 m below the weir crest level. Thus, in the second case (Series B) the hydraulic conditions within the fish pass reach a satisfactory level (from the fisheries point of view) before the weir starts to operate.
- To consider minor modifications to the entry and exit from the fish pass as necessary.

### 6.2 Development of general arrangement to be tested

The following points were agreed with the Project Board in setting up the general arrangement model:

1. The general arrangement testing would be based around the 'Case 1' demonstration exercise described in Chapter 2 of this report (i.e., a single unit Larinier fish pass alongside a 5 m Crump weir). The one deviation from 'Case 1' would be to increase the height of the weir to simulate conditions in which there is a greater need for a fish pass. A 1 metre head difference between upstream and downstream water levels was agreed. The Larinier fish pass would be used for flow measurement (i.e., there would be no separate Crump weir upstream of the fish pass to measure fish pass flows. This arrangement was judged to provide better conditions for migrating fish and also to shorten the overall length of the structure, and thus reduce costs.
2. The upstream entrance to the fish pass was to be a submerged orifice to minimise floating and demersal (bottom) trash ingress, and the orifice was to be large enough to avoid significant head losses and velocity increases at the upstream entry to the fish pass.
3. The downstream exit from the fish pass was to be a narrow open channel that would exit, as a definable angled jet, to the stilling basin of the gauging weir as far upstream as possible. A desirable exit velocity of 1-2 m/s was suggested.

## 6.3 General arrangement modelling

Details of the general arrangement modelling are:

1. The weir was set 1.0 m above bed level. This means that the head difference across the weir was 1.0 m at zero flow. However, as the flow increased, this difference decreased as the downstream water levels 'caught up' the upstream water levels (see *Figures 6.4 and 6.8*).
2. The Larinier fish pass was assumed to operate as a flow measurement device in accordance with the details given in Section 4.5.1 of this report. This implies the accurate construction of the upper fish pass baffles, good maintenance and the use of a variable coefficient of discharge.
3. The scale of the model was 1 in 5, thereby utilising the maximum capacity of the flume facility and avoiding undue scale effects.
4. Local velocities, flow patterns and head losses (where detectable) through the submerged upstream entry to the fish pass and also close to the downstream exit were measured. Photographic coverage was obtained (see Appendix L).
5. Two basic alternatives were considered for the fish pass. In the Series A tests, the Larinier fish pass was set with the horizontal section of the upper baffle (i.e., the invert of the pass for flow measurement) at weir crest level. In the Series B tests, the Larinier was set at a level 0.18 m below weir crest level.
6. Each of the two basic alternatives was studied at a series of steady-state flows that covered the range of conditions up to the point where the weir and the Larinier were becoming drowned.
7. Minor modifications were made to the submerged upstream entry to the fish pass after the Series A tests, to reduce head losses through the entry. Such head losses mean that the water level upstream of the fish pass is not the same as the water level upstream of the gauging weir, which has

significant effects on gauging accuracy. In the Series B tests the area of the upstream entry to the fish pass was 1.5 times that tested in Series A.

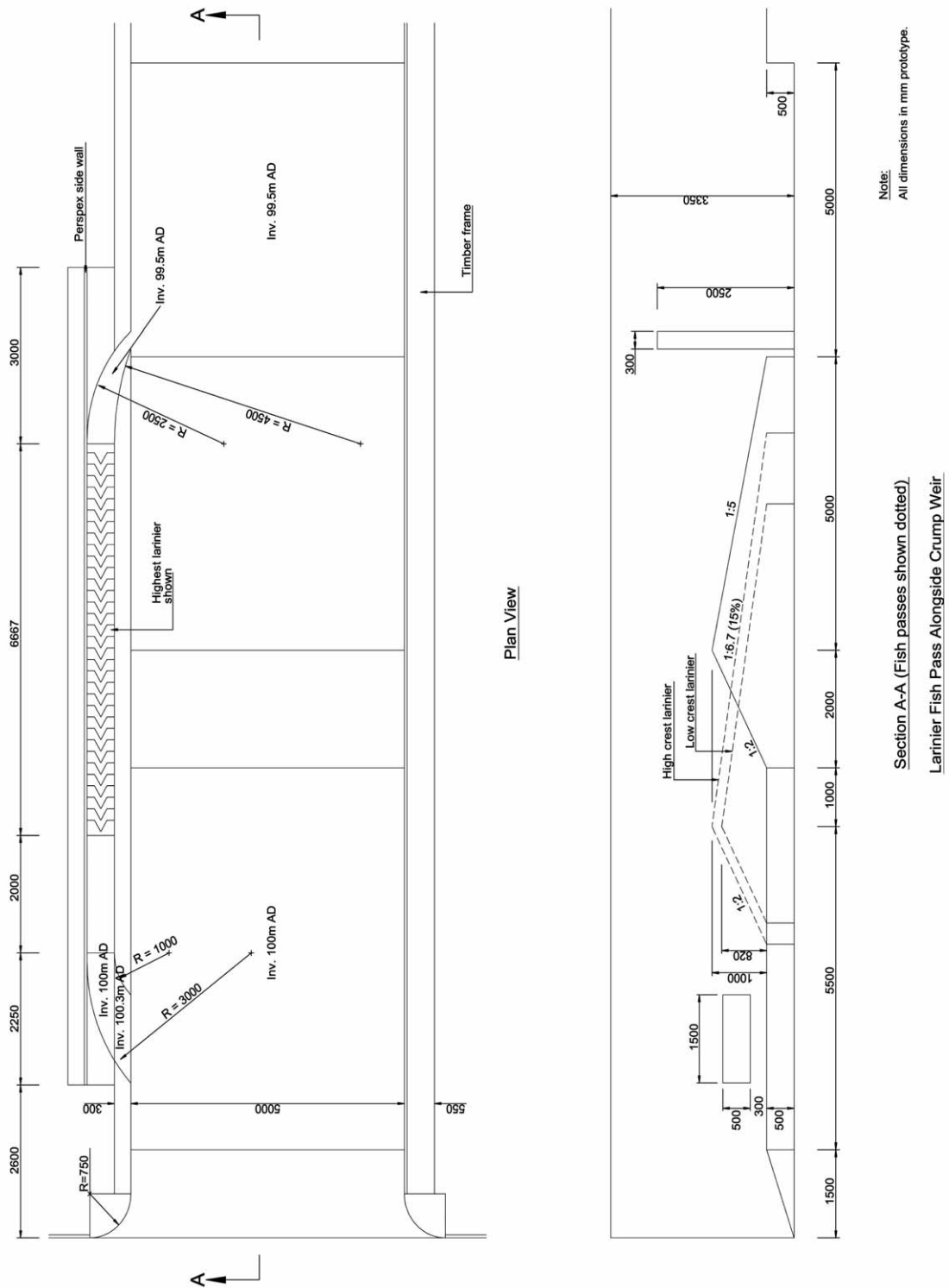
The general arrangements tested are shown in *Figure 6.1*.

The upstream entry to the fish pass took the form of a rectangular orifice 1.5 m wide by 0.5 m high for the Series A testing. This was increased to 2.25 m wide by 0.5 m high and the top and bottom edges, both on the upstream and downstream faces of the orifice, were given a radius of 50 mm for the Series B testing. The downstream exit from the fish pass took the form of a vertical slot 0.3 m wide in both series. The internal fish pass walls at both entry and exit were curved, as shown in *Figure 6.1*.

The exit from the fish pass was set just downstream of the truncation of the Crump weir, to provide optimum fish entry conditions on their upstream passage. The invert of the downstream exit from the fish pass was the same as the invert of the stilling basin, to ensure that water always stood against the base of the fish pass ladder.

*Note 1.* The downstream slope of a Larinier fish pass is 15 per cent, or 1 in 6.67. The downstream slope of a Crump weir is 20 per cent, or 1 in 5. This means that the Larinier fish pass tends to be longer than the weir in the direction of flow and the difference increases with weir height or head difference. If the fish pass is lower than the weir, as in Series B, this tends to shorten the fish pass in the direction of flow.

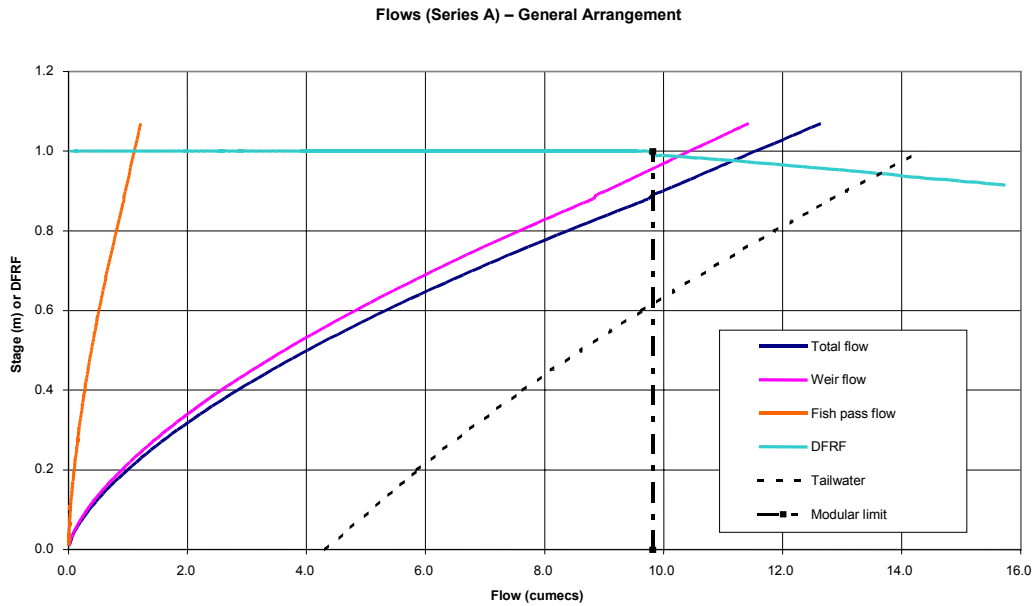
*Note 2.* The Larinier fish pass comprised a single continuous ladder of baffles. There is a limit to the length of a single continuous ladder of baffles defined by the judged stamina of ascending fish. Higher weirs or head differences probably require an intermediate pool, which would further increase the length of the fish pass. The current recommendation is that intermediate pools should be provided if the head difference is greater than 1.2 m, 1.5 m and 1.8 m for coarse fish, trout and migratory salmonids, respectively.



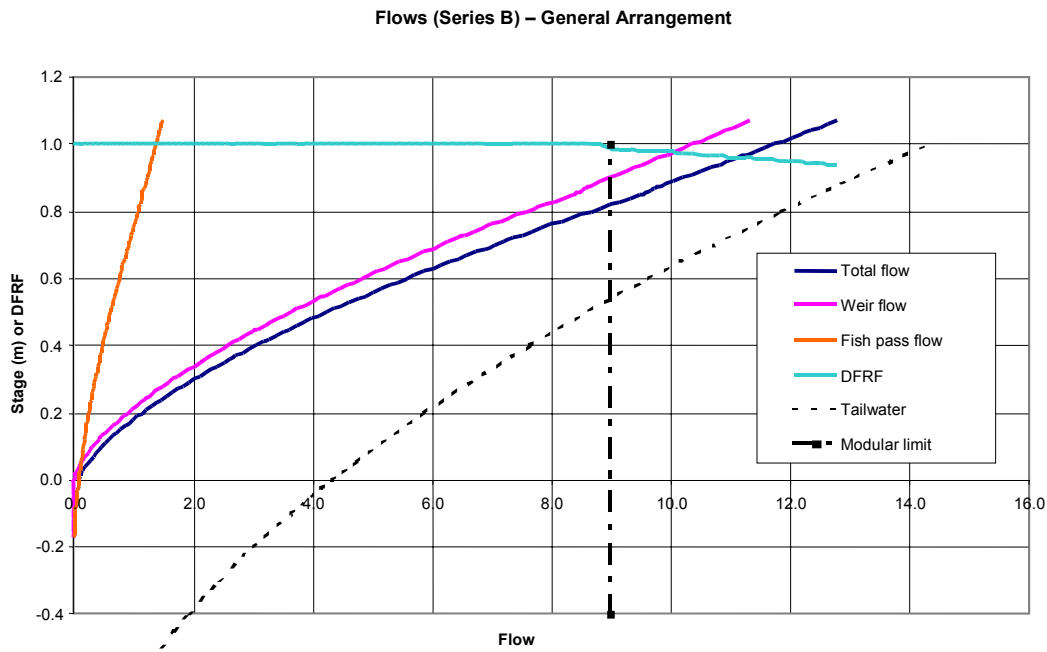
**Figure 6.1 General arrangement – Larinier fish pass alongside a Crump weir**

## 6.4 Flow characteristics

Flow characteristics are shown in *Figures 6.2* and *6.3* for Series A and Series B tests, respectively. These flow characteristics were derived using the methods described in Chapter 2.



**Figure 6.2 Larinier fish pass at weir crest level – Series A tests**



**Figure 6.3 Larinier fish pass 0.18 m below weir crest level – Series B tests**

*Note.* The modular limit is the condition when the combined weir and fish pass flows are reduced by 1 per cent from the modular flow calculation (i.e., the DFRF is 0.99). The fish pass will tend to reach its modular limit first if it is at,

or below, the level of the weir. This is because of its inherently lower individual modular limit.

## 6.5 Test results – Series A, Larinier fish pass at weir crest level

All the results given in this section are in terms of prototype, not model, values.

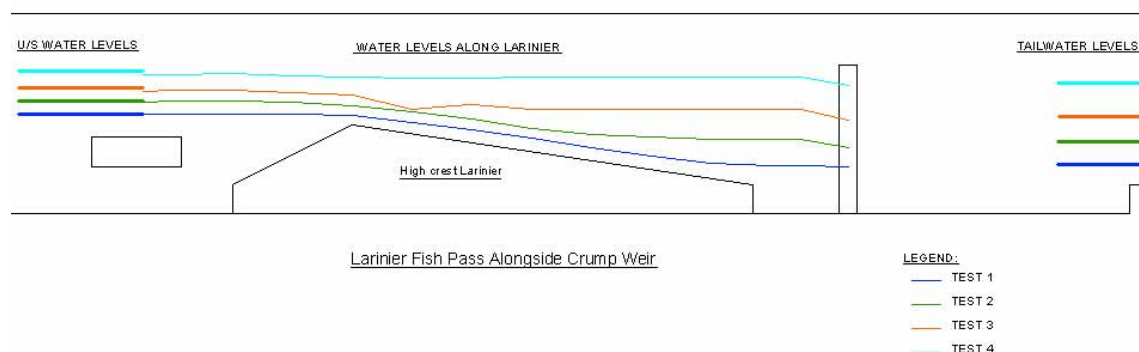
Four steady-state tests were carried out in Series A to cover the range of flows up to the point where the modular limit of the combined gauging structure–fish pass was reached. These are summarised in *Table 6.1*.

**Table 6.1 Series A tests parameters**

Head on the weir (m)	Total flow through the system (m <sup>3</sup> /s)	Weir flow (m <sup>3</sup> )	Fish pass flow (m/s)	Notes
0.18	0.84	0.76	0.08	Minimum head for satisfactory flow conditions through the fish pass
0.40	2.84	2.57	0.27	Intermediate condition
0.60	5.33	4.82	0.51	Maximum head for satisfactory flow conditions through the fish pass
0.88	9.74	8.81	0.93	Onset of drowning

### 6.5.1 Water surface profiles through the fish pass

Water surface profiles through the fish pass for the Series A tests are shown in *Figure 6.4*.



**Figure 6.4 Water surface profiles through the fish pass for the Series A tests**

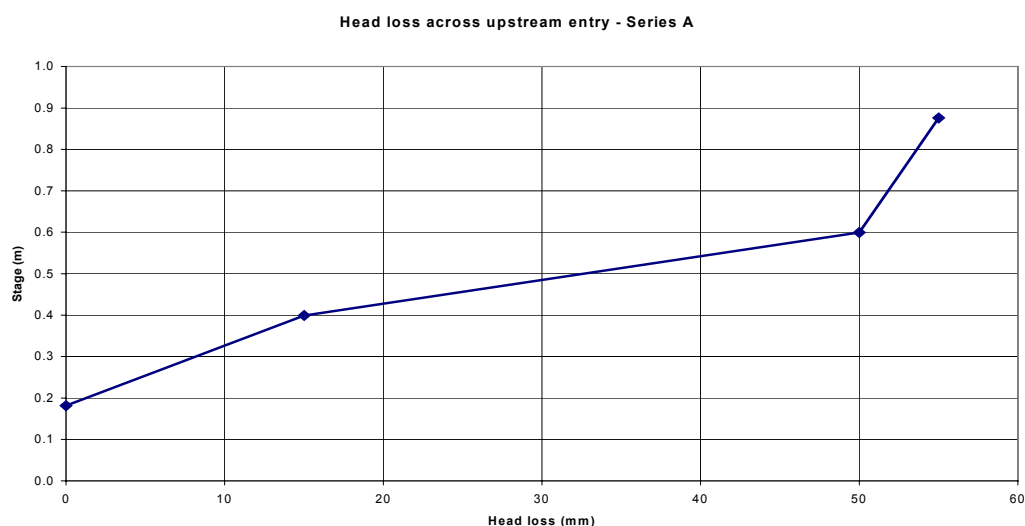


The surface profiles show satisfactory flow conditions for the passage of fish throughout the flow range. At low flows the downstream end of the fish pass cascade is always submerged and fish have easy access. As flows increase a weak hydraulic jump is formed, which increases in strength as it migrates towards the crest. At the high end of the flow range tested, the fish pass drowns and there is only a small head loss through the system.

### 6.5.2 Head losses through the upstream entry to the fish pass

Head losses through the upstream entry to the fish pass for the Series A tests are shown in *Figure 6.5*.

The question of head losses through the upstream orifice to the fish pass is important because excessive head losses require the use of an additional stage recorder in the fish pass channel so that flows can be calculated (separately) for the fish pass.



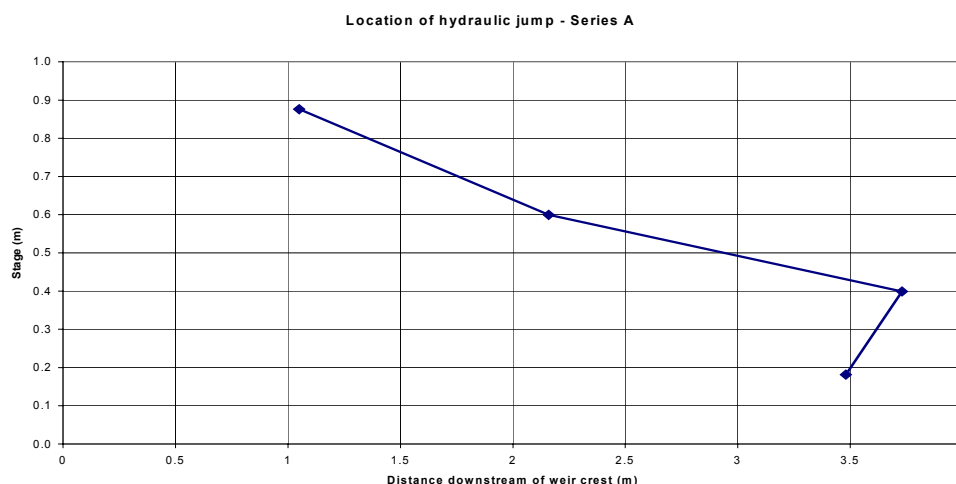
**Figure 6.5 Head losses through the upstream entry to the fish pass for the Series A tests**

In the Series A tests a head loss of 55 mm was recorded when conditions approached drowning. At this stage the head on the Crump weir was 880 mm. Only one head recorder on the weir, and with the assumption that the fish pass stage was the same, represents an uncertainty in head of around 6 per cent and an uncertainty in fish pass flow of around 9 per cent. However, under these flow conditions, the weir flow was 8.81 m<sup>3</sup>/s and the fish pass flow was 0.93 m<sup>3</sup>/s (i.e., 10.5 per cent of the weir flow). Thus, an uncertainty of 9 per cent in the fish pass flows only represents an uncertainty of 0.95 per cent in total flow. This is small, but possibly significant.

To further reduce the uncertainties, the size of the upstream orifice was increased by 50 per cent, and rounding of the edges was introduced where practicable, for the Series B tests.

### 6.5.3 Location of the hydraulic jump on the weir

The location of the hydraulic jump for the Series A tests is shown in *Figure 6.6*.



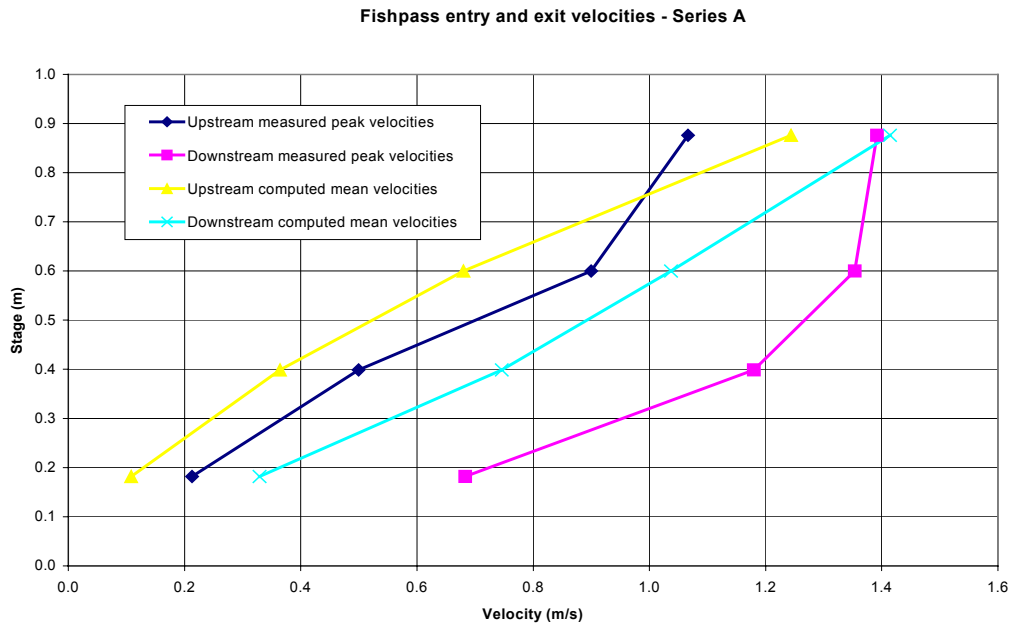
**Figure 6.6** Location of the hydraulic jump for the Series A tests

In the general arrangement testing, the Crump weir was truncated 5.0 m downstream of the crest.

*Figure 6.6* shows that the hydraulic jump remained on the downstream face of the weir throughout the range of flows tested. At low flows the hydraulic jump was around 1 m upstream of the truncation position. Thus, sub-critical flows filled the stilling basin, which provided suitable conditions for fish. The ideal location for the downstream exit from the fish pass was considered to be just downstream of the hydraulic jump, and this certainly applied at low flows. At higher flows the hydraulic jump migrated upstream, but this is inevitable as flow conditions approach the modular limit. The hydraulic jump dissipated completely on the point of drowning.

### 6.5.4 Water velocities at the entry to and the exit from the fish pass

Water velocities at the entry to and the exit from the fish pass for the Series A tests are given in *Figure 6.7*.



**Figure 6.7 Water velocities at the entry to and the exit from the fish pass for the Series A tests**

Velocities were measured with a miniature propeller meter close to the upstream entry to the fish pass, and also close to the downstream exit from the fish pass. The location of the meter was adjusted to measure the peak velocity in all cases. Mean velocities through the upstream entry to the fish pass were calculated from a knowledge of the flow through the fish pass and also of the cross-sectional area of the upstream orifice. Mean velocities through the downstream exit from the fish pass were calculated from a knowledge of the flow through the fish pass, the width of the downstream exit and the tailwater depth.

The measured peak velocities are, in general, higher than the computed mean velocities. The anomalies at the maximum flow occur because the fish pass is beginning to drown, a factor not taken into account in the calculations.

The agreed maximum head on the Larinier fish pass for satisfactory flow conditions for fish migration is 0.60 m. Under these flow conditions peak and mean velocities at the upstream entry were 0.90 m/s and 0.68 m/s. The corresponding figures at the downstream exit were 1.35 m/s and 1.04 m/s.

The agreed minimum head on the Larinier fish pass for satisfactory flow conditions for fish migration is 0.18 m. Under these flow conditions peak and mean velocities at the upstream entry were 0.21 m/s and 0.11 m/s. The corresponding figures at the downstream exit were 0.68 m/s and 0.33 m/s.

## 6.6 Test results – Series B, Larinier fish pass 0.18 m below weir crest level

Five steady-state tests were carried out in Series B, again covering the range of flows up to the point where the modular limit of the combined gauging structure–fish pass was reached. These are summarised in *Table 6.2*.

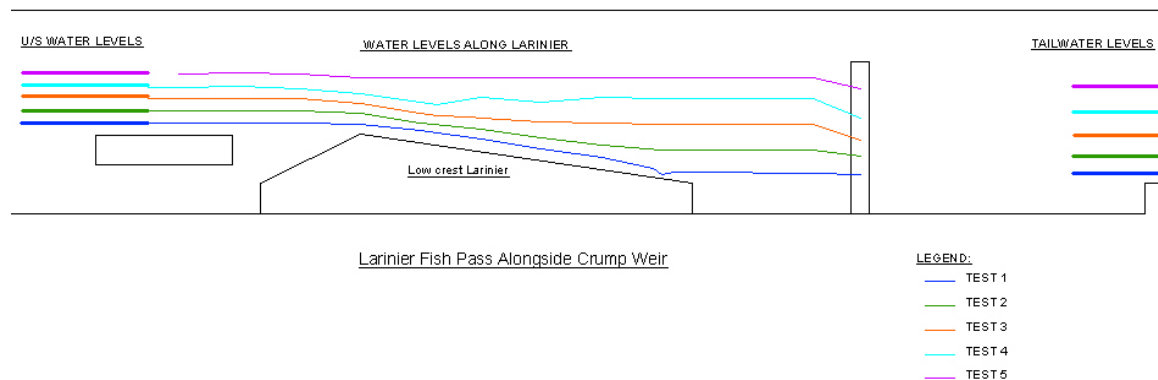
**Table 6.2 Series B tests parameters**

Head on the weir (m)	Total flow through the system (m <sup>3</sup> /s)	Weir flow (m <sup>3</sup> /s)	Fish pass flow (m <sup>3</sup> /s)	Notes
0.00	0.08	0.00	0.08	Minimum head for satisfactory flow conditions through the fish pass
0.20	1.14	0.89	0.25	Intermediate condition
0.42	3.27	2.77	0.50	Maximum head for satisfactory flow conditions through the fish pass
0.60	5.57	4.82	0.75	Intermediate condition
0.81	8.82	7.73	1.09	Onset of drowning

### 6.6.1 Water surface profiles through the fish pass

Water surface profiles through the fish pass for the Series B tests are shown in *Figure 6.8*.

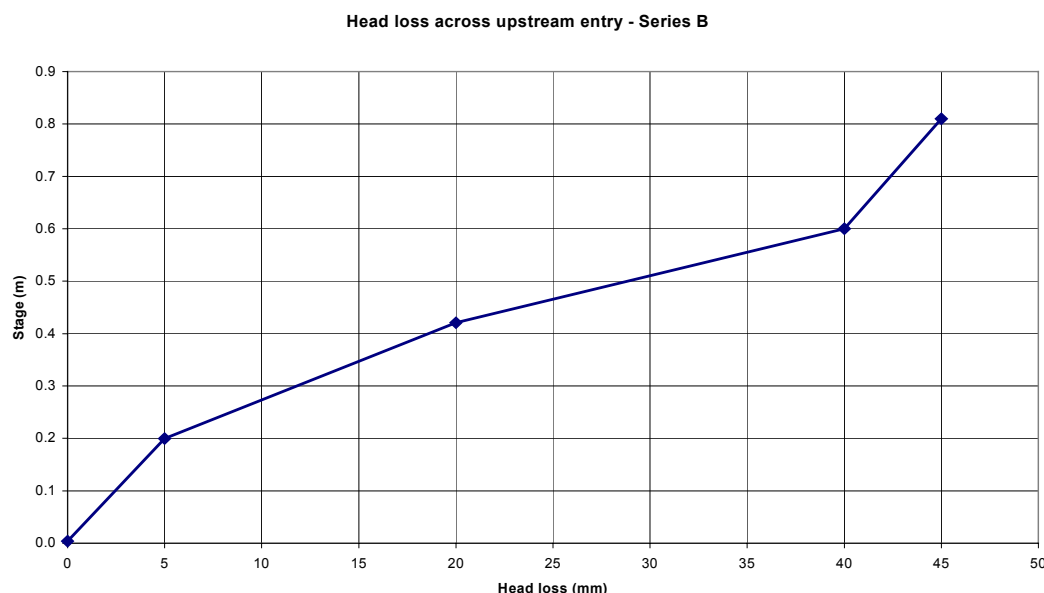
As in the Series A tests, the surface profiles for the Series B tests show satisfactory flow conditions for the passage of fish throughout the flow range. At low flows the downstream end of the fish pass cascade is always submerged and fish have easy access. As flows increase a weak hydraulic jump is formed, which increases in strength as it migrates towards the crest. At the high end of the flow range tested, the fish pass drowns and there is only a small head loss through the system.



## Figure 6.8 Water surface profiles through the fish pass for the Series B tests

### 6.6.2 Head losses through the upstream entry to the fish pass

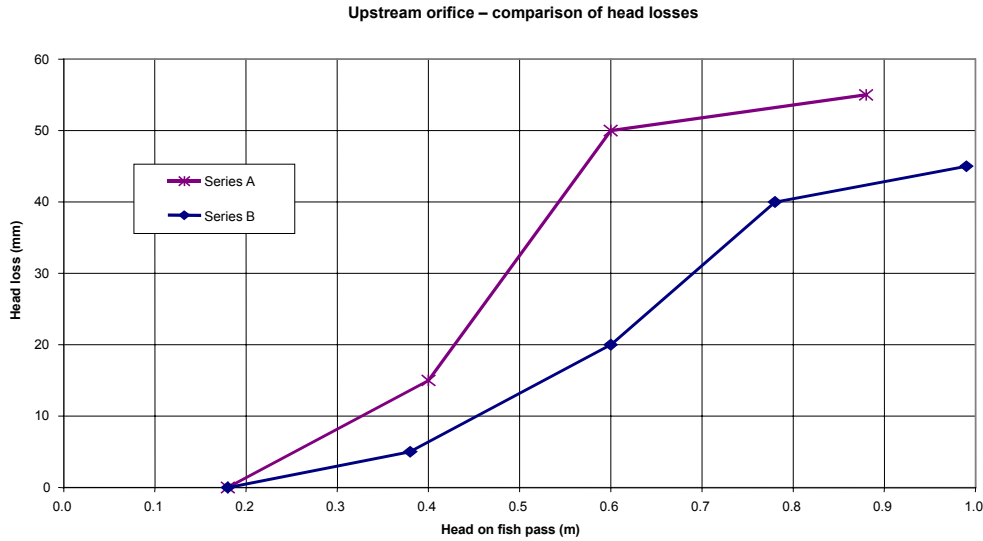
Head losses through the upstream entry to the fish pass for the Series B tests are shown in *Figure 6.9*.



**Figure 6.9 Head losses through the upstream entry to the fish pass for the Series B tests**

In the Series B tests a head loss of 45 mm was recorded when conditions approached drowning. This is slightly lower than in the Series A tests, despite the larger flows through the fish pass because of the revised orifice design. At this stage the head on the Crump weir was 810 mm. Only one head recorder on the weir, and with the assumption that the fish pass stage was the same, represents an uncertainty in head of around 5 per cent and an uncertainty in fish pass flow of around 8 per cent. Under these flow conditions, the weir flow was 7.73 m<sup>3</sup>/s and the fish pass flow was 1.09 m<sup>3</sup>/s (i.e., 14 per cent of the weir flow). Thus, an uncertainty of 8 per cent in the fish pass flows represents an uncertainty of 1.1 per cent in total flow.

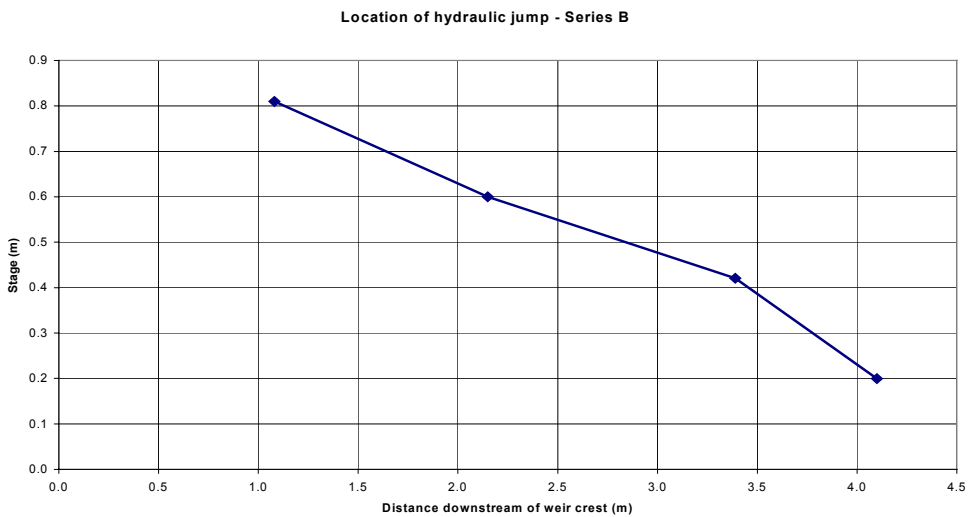
Compared to the Series A tests, in the Series B tests a higher proportion of the total flow always passes through the fish pass because of its lower elevation. Additionally, the head on the fish pass at which the combined structure drowns is higher than in the Series A tests. To look at the effect of increasing the size of the upstream orifice by 50 per cent and of rounding the edges it is necessary to compare like with like. This comparison is made in *Figure 6.10*, in which head losses through the Series A and Series B orifices are compared at similar heads on (flows through) the fish pass. The benefits gained by the larger orifice used in the Series B tests is clear – head losses are significantly reduced at similar heads (flows).



**Figure 6.10** The effect of upstream orifice size on head losses based on the Series A and Series B results

### 6.6.3 Location of the hydraulic jump on the weir

The location of the hydraulic jump for the Series B tests is shown in Figure 6.11.



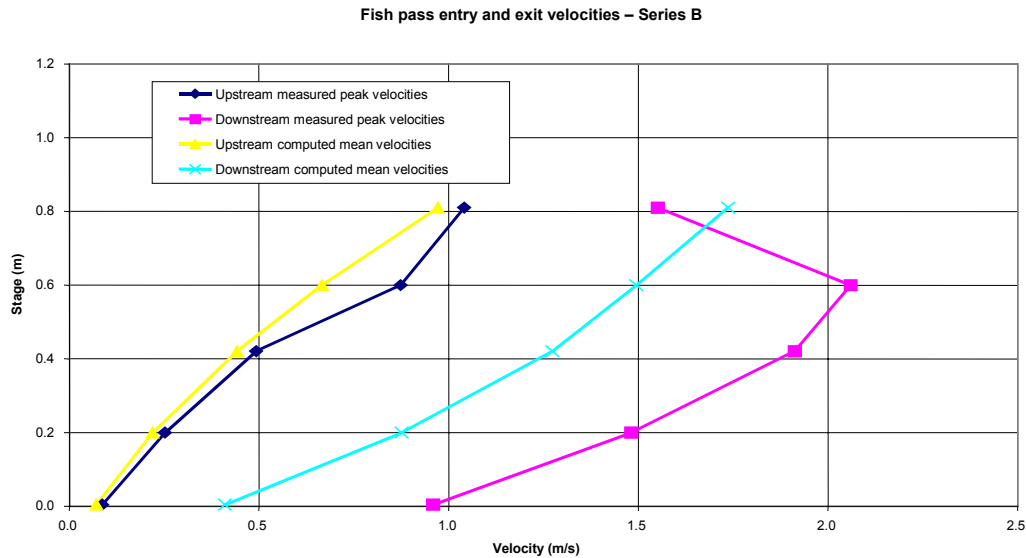
**Figure 6.11** Location of the hydraulic jump for the Series B tests

Figure 6.11 shows that the hydraulic jump again remained on the downstream face of the weir throughout the range of flows tested. At low flows the hydraulic jump was around 1 m upstream of the truncation position. Thus, sub-critical flows filled the stilling basin, which provided suitable conditions for fish. The ideal location for the downstream exit from the fish pass was considered to be just downstream of the hydraulic jump, and this certainly applied at low flows. At higher flows the hydraulic jump migrated upstream,

but this is inevitable as flow conditions approach the modular limit. The hydraulic jump dissipated completely on the point of drowning.

#### 6.6.4 Water velocities at the entry to and the exit from the fish pass

Water velocities at the entry to and the exit from the fish pass for the Series B tests are shown in *Figure 6.12*.



**Figure 6.12 Water velocities at the entry to and the exit from the fish pass for the Series B tests**

The measured peak velocities for Series B are again, in general, higher than the computed mean velocities. Any anomalies at the maximum flow occur because the fish pass is beginning to drown, a factor not taken into account in the calculations.

The agreed maximum head on the Larinier fish pass for satisfactory flow conditions for fish migration is 0.60 m. In the Series B tests the corresponding head on the weir is 0.42 m. Under these flow conditions, peak and mean velocities at the upstream entry were 0.49 m/s and 0.44 m/s. The corresponding figures at the downstream exit were 1.91 m/s and 1.27 m/s.

The agreed minimum head on the Larinier fish pass for satisfactory flow conditions for fish migration is 0.18 m. In the Series B tests the corresponding head on the weir is zero. Under these flow conditions peak and mean velocities at the upstream entry were 0.09 m/s and 0.07 m/s. The corresponding figures at the downstream exit were 0.96 m/s and 0.41 m/s.

## 6.7 Conclusions

### 6.7.1 General

In general, the test facilities, designed according to the methods described in Chapter 2, provided suitable hydrometric and fish migration conditions throughout the design flow range. This observation applies to both series of tests (i.e., conditions in which the fish pass is level with the weir level and conditions in which the fish pass is 0.18 m below weir level).

### 6.7.2 Flow conditions at the upstream entry to the fish pass

The question of head losses through the upstream orifice to the fish pass is important because excessive head losses require the use of an additional stage recorder in the fish pass channel so that flows could be calculated (separately) for the fish pass.

The requirements for the upstream entry are that head losses should not significantly degrade flow measurement and that velocities should not be so high as to impede fish movement.

In Series A the upstream entry to the fish pass was through a submerged rectangular orifice with a cross-sectional area of 0.75 m<sup>2</sup>. The average velocities through this orifice would not impede fish movement, being 0.11 m/s at the minimum recommended fish pass head of 0.18 m, and 0.68 m/s at the maximum fish pass head of 0.60 m (see *Figure 6.7*). However, head losses through the orifice caused concern to the hydrometric interests (see *Figure 6.5*), and it was agreed to increase the size of the orifice to 1.125 m<sup>2</sup> for the Series B tests.

In Series B the average velocities through the enlarged orifice were 0.07 m/s at the minimum recommended fish pass head of 0.18 m, and 0.44 m/s at the maximum fish pass head of 0.60 m (*Figure 6.12*). These velocities would not impede fish movement.

For a given flow through the fish pass a significant reduction in head loss was observed in Series B, which provides clear justification for the enlarged upstream entry (see *Figures 6.9 and 6.10*). Thus, for a single unit Larinier fish pass the submerged entry orifice should be not less than 1.125 m<sup>2</sup>. For installations with more than one Larinier unit the size of the orifice should increase proportionately (i.e., 2.25 m<sup>2</sup> for two units, etc).

### 6.7.3 Flow conditions at the downstream exit from the fish pass

The requirement for the downstream exit from the fish pass is that it should provide a definable jet of water to which migrating fish would be attracted. Preferably, this jet is to issue immediately downstream of the hydraulic jump formed on the downstream face of the gauging weir.



In both series of tests, at low flows the hydraulic jump formed just upstream of the fish pass exit slot. The hydraulic jump migrated upstream as flows increased, until drowning occurred. This cannot be avoided. However, the weir truncation acts as a guide to fish to some extent.

In Series A the average velocities through the downstream exit from the fish pass were 0.33 m/s and 1.04 m/s at the minimum and maximum recommended fish pass flows, respectively (see *Figure 6.7*). The corresponding figures for Series B were 0.41 m/s and 1.27 m/s (*Figure 6.12*). These results illustrate the difficulty in generating high exit velocities when flows through the fish pass are at the lower end of the range. These figures are to be compared with the desired range, from a fisheries point of view, of 1-2 m/s.

#### **6.7.4 Flow conditions within the fish pass**

The requirement for flows within the fish pass is that the hydraulic jump, if present, should not occur downstream of the most downstream baffle of the fish pass, which would create difficult access for migrating fish.

Water surface profiles through the fish pass for the Series A and Series B tests are shown in *Figures 6.4* and *6.8*. At low flows the tailwater level remains above the most downstream baffle of the fish pass, and thereby provides suitable conditions for migrating fish. As flows increase, the hydraulic jump moves upstream until the onset of drowning, when sub-critical flow conditions occur throughout the fish pass.

#### **6.7.5 Flow conditions within the stilling basin of the measuring weir**

To facilitate fish migration it is important that flow conditions in the stilling basin are sub-critical and that there is little instability in terms of large-scale eddies, which cause orientation problems for migrating fish.

In all the Series A and Series B tests a stable hydraulic jump was formed on the one in five downstream slope of the Crump weir – this downstream slope was chosen by E S Crump because of this particular characteristic. Flows that entered the stilling basin were sub-critical and free of large-scale eddies throughout the flow range for both series of tests.

*Note.* The Project Board acknowledges that the arrangements tested are not suitable for all species of fish. For example, shad do not like turbulent type fish passes and require an entry at least 0.45 m wide. Also, small species like bullhead, stoneloach, etc., are unlikely to be accommodated by this type of arrangement.

# 7. Conclusions and recommendations

## 7.1 Introduction

The work in Phase 2 of this research project was divided into five studies:

- Study A** Desk study of the combined uncertainties associated with the introduction of fish passage aids at standard flow measurement structures
- Study B** A review of the problems of trash at fish passes and ways to minimise accumulations
- Study C** Laboratory tests to provide an accurate hydrometric calibration of a Larinier fish pass
- Study D** Fundamental requirements for the near-crest arrangements of baffles on the downstream face of a measuring weir
- Study E** Laboratory testing of a Larinier fish pass with a submerged orifice upstream intake set alongside a non-specific flow measurement structure

Conclusions and recommendations from these five studies are given in Sections 7.2 and 7.3.

## 7.2 Conclusions

### 7.2.1 Study A. Desk study of the combined uncertainties associated with the introduction of fish passage aids at standard flow measurement structures (Chapter 2)

#### 7.2.1.1 Scope

The broad aims of this study were to look at three typical river situations and four gauging structure–fish pass combinations. In each case we have sought to show (a) how flows through the devices and (b) uncertainties in gauged flow vary with river flow. The aims were thus achieved by looking at typical test cases. To that extent this is a demonstration study. It relies heavily on the design assumptions made and the nature of the test-case rivers chosen. The Project Board has given valuable assistance in choosing the size and nature of the rivers, the gauging structures and the fish passes.

The approach comprised the components:

- consider typical hydraulic and hydrological natural physical characteristics of three test-case rivers that covered bed widths of between 5 m and 20 m;

- consider Crump (5 m), flat-V (5 m and 10 m) and compound Crump (20 m) weirs;
- determine a consistent design procedure for gauging structures (i.e., their sizing and elevation relative to consistent modular and non-modular flow criteria);
- determine a consistent design procedure for fish passes (Larinier type in all cases), that is width of pass and relative elevation of flow inlet to weir crest to meet consistent flow attraction criteria;
- design of gauging structure–fish pass systems;
- identify a simple, but reasonably accurate, flow calibration for Larinier fish passes;
- compute flow distributions between the fish pass and the weir(s);
- compute combined uncertainties in flow measurement

### **7.2.1.2 Conclusions: flow results**

The flow results, given fully in Appendix C, cover a range of sizes of river and particular gauging structure–fish pass combinations. However, the designer may be faced with conditions that are not covered in the current study and hence it is important to extract broad conclusions that may be of more general application.

### **Computation of flows**

The computation of flows using the method described in this section gives important information regarding individual flows through each section of a gauging structure and through the fish pass. This detailed analysis is essential to determine uncertainties (see Section 2.9), and requires the development of suitable software.

### **Modular limits of gauging structures**

The  $Q_7$  criterion for the discharge at which the gauging structure reaches its modular limit leads to the construction of low crest height weirs, particularly in small rivers, where there is little justification for the inclusion of a fish pass. Some evidence suggests that gauging structures have been installed with lower flows,  $Q_{>7}$ , at their modular limit. However, many river structures in the UK (both gauging and non-gauging) are much higher and remain modular to a much higher flow. In general:

- The higher the structure, the higher the discharge at the modular limit. Increasing the crest height gives a wider range of flows that can be measured in the modular flow range, where structures are more accurate. The need for a fish pass increases as the crest level of the gauging structure is raised.
- If the only hydrometric interest at a particular location is in the measurement of low flows, a modest low flow structure can be installed (and operated according to standards in the modular flow range) and the implications to fisheries interests are likely to be minimal. Where the requirements are to measure medium and high flows with accuracy, the need for satisfactory fish passes increases.

### **Attraction flows for fish passes**

The method used to determine the number of fish pass units required for any particular duty seeks to provide a satisfactory flow through the fish pass to attract fish towards the pass. In the present context it is assumed that this flow corresponds with the maximum design head on the fish pass. For the Larinier fish pass with 100 mm baffles this head is currently quoted as 0.42 m. The flow over the gauging structure when the head on the Larinier reaches 0.42 m depends on the nature and level of the gauging structure relative to the fish pass. In most cases a significant percentage of the total flow passes over the gauging structure when this condition is reached. In general:

- The lower the fish pass is set relative to the gauging structure, the higher is the percentage of the total flow taken by the fish pass. If the fish pass is set with the upstream baffle below the (lowest) crest of the gauging structure, there will be times when 100 per cent of the total flow is taken by the fish pass. This could potentially have serious implications regarding hydrometric accuracy (see Section 2.9).
- As river flow varies, the gauging structure usually has a major influence on upstream water levels. The influence varies with the type of gauging structure. For example, a flat-V weir increases upstream levels faster than a Crump weir of similar breadth, and thus provides greater flow gauging sensitivity at low-to-medium flows. As a result of this, flows to the fish pass are larger, all other things being equal, and the rapid head rise at the flat-V weir may take the fish pass flows outside its operating range sooner.
- The Project Board is of the opinion that the laboratory testing described in Chapter 4 has shown that the maximum head on a Larinier fish pass with 100 mm baffles may be increased from 0.42 m to 0.60 m. This change indicates that the number of Larinier units may be reduced at a particular site. However, the maximum limit of 0.6 m also introduces changes in the flow distribution between the gauging structure and fish pass, and in the head at which fish pass 'attraction flows' are reached. A full evaluation of the implications to the four demonstration cases was not possible within the current study and requires suitable software to be developed.

#### **7.2.1.3 Conclusions: uncertainty results**

The computation of uncertainties using the method described in Section 2.9 gives important information regarding overall uncertainties through gauging structure–fish pass combinations based on published information in standards.

#### **Uncertainty plots (Appendix D)**

The plots given in Appendix D show how the overall uncertainty varies with river flow for a range of 'typical' situations. The Environment Agency, and anyone else concerned with in water resources or water quality, are interested in the uncertainty of the volume of water that passes a particular location over an extended period. The plots show uncertainties that, under certain conditions, are much higher than the acceptable uncertainty in volumes over extended periods.

### **Low heads**

All gauging structures yield high uncertainties at low heads, almost entirely because of the difficulties in measuring small values of head. This shows the need to develop highly accurate and stable instrumentation to measure head and also the need to maintain and check this instrumentation regularly.

### **Compound gauging structures**

Compound structures have the advantage that they can, by design, cover an extremely wide range of flows without undue raising of upstream (flood) levels. However, there is a discontinuity in the uncertainty curve when higher crests come into operation. The much higher overall uncertainties result from difficulties associated with estimating the head on the higher crest. Two factors come into play:

- the small value of the head;
- the fact that the head is not measured directly, but has to be estimated from the low crest head measurement

Uncertainties could be reduced by having a second head measurement for the high crest and/or the fish pass, but this incurs additional costs in maintaining the installation and in processing the data.

### **Drowning of the gauging structure**

Gauging structures that can be operated in the drowned flow range were developed to provide flow measurement with little afflux (i.e., little drop in water levels from upstream to downstream). They have applications in canal and river situations where head losses are at a premium. In rivers they provide lower structures than would otherwise be needed and have environmental and flood mitigation advantages. However, operation of standard structures in the drowned flow range involves two measurements of head – one upstream and one downstream. The latter, in the case of Crump and flat-V weirs, is best achieved by measuring the head in the separation pocket that occurs just downstream of the crest line. Downstream gauges are permitted, but uncertainties in flow measurement are higher.

### **Gauging structure–fish pass combinations**

A fish pass can be regarded as an additional section of a compound weir. Regardless of the flow measurement uncertainty associated with the fish pass itself, there is additional overall uncertainty because the head upstream of the fish pass is not normally measured directly. Hence it is subject to the compound weir ‘transfer’ uncertainty.

Research into fish pass design is ongoing and it is significant that no British or International Standards deal with fish pass design. Hence there are no published definitive hydrometric calibrations of fish passes. In this study we have assumed that the uncertainties in flow measurement at the fish pass are a multiple of the overall uncertainties at the gauging structure.

## **7.2.2 Study B. Review of the problems of trash at fish passes and ways to minimise accumulations (Chapter 3)**

### **7.2.2.1 Scope**

In considering the impact of fish passage aids on flow measurement accuracy at weirs, the matter of trash retention and accumulation is of primary importance for two reasons:

- retained trash very quickly makes a pass no longer passable for fish;
- retained trash may change the flow calibration for the weir (or weir and fish pass combination) as a gauging station.

The latter point is of great significance where accurate low-flow gauging is a high priority. Traditionally, local Environment Agency fishery officers have accepted that passes have to be inspected and trash cleared manually on a regular basis. This has implications as to Health and Safety for Environment Agency personnel. Any improvement in present arrangements to prevent trash accumulating would therefore increase the efficiency of passes, improve flow measurement accuracy and reduce maintenance costs to the Environment Agency.

Chapter 3 reports a study of trash accumulation at river structures. In summary, the objectives were:

- to review the methods in use to minimise trash accumulation on in-river structures, including fieldwork and a literature search;
- to provide guidance on the design and selection of fish passage aids;
- to recommend further desk or laboratory studies required.

Detailed findings of the trash study are given in Sections 3.5-3.10, but the important general conclusions are given here.

### **7.2.2.2 Conclusions**

1. The fieldwork was undertaken in November and December 2003 when trash problems caused by the autumn fall were clearly in evidence.
2. All Environment Agency Regions were visited, with the exception of the Anglian Region, where fish passage aids are not common.
3. The inspections are thought to have covered between 5 and 10 per cent of the fish passes in England and Wales.
4. The types of fish passes inspected included:
  - pool and traverse;
  - side baffle, including Denil;
  - easement devices, including 'Hurn'-type baffles;
  - bottom baffle, Larinier.
5. The literature search yielded very little useful information on methods to avoid trash problems, but see Section 3.6.

6. Section 3.7 deals with those factors that influence trash retention at fish passage aids. The effectiveness and selection of anti-trash devices are discussed in relation to:
  - screens
  - fixed deflectors
  - floating booms
  - positioning of enclosed fish passes.
7. Section 3.8 deals with those factors that influence trash retention specifically at weirs. Types considered are:
  - flat-V weirs
  - Crump weirs.
  - horizontal broad-crested weirs
  - non-gauging weirs and natural obstructions.
8. The strengths and weaknesses of anti-trash devices are given separately for screens, fixed deflectors and floating booms in Section 3.9. While many factors apply to the different types, one common theme is the requirement for regular inspection and maintenance, both to ensure that the fish pass remains effective as far as fish migration is concerned and also to maintain the head–discharge relationship if accurate flow measurement is to be achieved.

### **7.2.3 Study C. Laboratory tests to provide an accurate hydrometric calibration of a Larinier fish pass (Chapter 4)**

#### **7.2.3.1 Scope**

The popularity of Larinier fish passes is increasing and their usage is likely to become widespread in the UK. Thus, there is a need to provide calibration data to hydrometric standards if they are to be considered for flow measurement alone or as part of a combined flow measurement system.

The objectives of this current study were twofold:

- to provide calibration data and modular limit data for Larinier fish passes;
- to investigate modifications at the upstream end that will improve hydrometric accuracy.

#### **7.2.3.2 Conclusions: the basic Larinier fish pass**

##### **Modular flow calibration**

When a Larinier fish pass first spills, it does so over the transverse section of the most upstream baffle. As the flow increases, the 'herring bone' section of the upstream baffle is progressively over-topped until, at a head of 45 mm, flow occurs over all sections of the upstream baffle (and similar flow conditions prevail at all the other baffles). At this stage the flow is highly three-dimensional. As the flow continues to increase, the flow pattern becomes progressively more two-dimensional (forward and vertical motions only) until, at a head of around 200 mm, the flow pattern settles to a quasi two-

dimensional state in which the baffles could be regarded as bed roughness elements rather than 'weirs' in their own right.

These three phases are shown very clearly in *Figure 4.2*. The rising coefficient value up to a head of around 70 mm represents the range in which the flow conditions are highly three-dimensional and the crest length is changing with flow. The coefficient value rises because the effective crest length and flow directions change as the flow changes. The falling coefficient value from a head of around 70 mm to around 250 mm is the range in which the flows become progressively more two-dimensional. Finally, the constant coefficient above a head of 250 mm is the quasi two-dimensional phase.

### **Modular limit**

The modular limit of a gauging structure is an important factor because it determines how easily the structure drowns. A thin plate weir, for example, starts to drown as soon as the downstream water level reaches crest level. However, a Crump weir does not start to drown until the downstream total head reaches 75 per cent of the upstream total head. Under these conditions downstream water levels are normally well above crest level. The latter type of weir is therefore far less susceptible to downstream effects.

The modular limit of the Larinier fish pass was evaluated using the same half-scale model as used for the modular flow tests. The procedure was to set a particular discharge and to carry out tests with a series of increasing tailwater levels. The initial tailwater level was sufficiently low to ensure modular flow and the increments by which tailwater levels were raised were chosen such that flow conditions would become drowned in the latter stages. These test series were carried out at three specific modular heads (flows) to evaluate any changes in the modular limit with flow. The nominal heads chosen were 0.2 m, 0.4 m and 0.6 m, which covered the operational range of the fish pass.

From a flow gauging point of view the Larinier fish pass is a mixture between a thin-plate weir (the baffles) and a triangular profile weir (the longitudinal profile of the fish pass). Thin-plate weirs have very low modular limits (0 per cent) and triangular profile Crump weirs have relatively high modular limits (75 per cent). The results for the Larinier fish pass fit logically between these values, with the modular limit tending to reduce at low heads when the baffles become more dominant and to increase at high heads when the general triangular profile of the fish pass dominates. The observed modular limits in terms of  $H_2/H_1$  are in the range 35 per cent at low heads to 55 per cent at high heads.

### **7.2.3.3 Conclusions: flow gauging adaptation at the head of a Larinier fish pass**

It has been shown that the Larinier fish pass has some shortcomings in terms of its use as a flow gauging structure. These shortcomings could be overcome if a carefully designed gauging structure were to be placed upstream of the fish pass. However, hydraulic testing of this arrangement was considered important, to look at flow patterns and to evaluate the implications of these in



terms of the ability of fish to negotiate the fish pass and the gauging structure sequentially.

The important factors in terms of maintaining the ability of fish to migrate through the system are:

1. The gauging structure must be set at a level not much higher than the head of the fish pass, to minimise the magnitude of this additional 'hurdle' as far as fish are concerned.
2. The gauging structure must be high enough to ensure that modular flow conditions, and hence gauging accuracy, are maintained up to a defined flow rate.
3. The area between the fish pass and the gauging weir – the intermediate pool – must provide an area of relatively low velocity in which fish can rest before negotiating the gauging weir.

The third factor requires that the hydraulic jump which forms downstream of the gauging weir should not enter the 'resting' area, but should sit on the downstream face of the gauging structure throughout the design flow range. This is best achieved using a triangular profile Crump weir with its gradually sloping downstream face. To meet all three factors, the crest breadth of the gauging weir must be the same as, or very similar to, the width of the fish pass, such that the head–discharge relationship of the gauging weir is similar to that of the fish pass. This means that where there are several Larinier units side by side, the Crump weir should be a single unit with a crest breadth equal to the combined width of the Larinier units.

In formulating the arrangement to be hydraulically tested in the HR Wallingford facility, the design flow range chosen was the (extended) range of the Larinier fish pass (i.e., the arrangement was to perform satisfactorily up to a head on the fish pass of 0.6 m, rather than the 0.42 m quoted by Larinier). The height of the crest of the Crump weir above the head of the fish pass was chosen such that the gauging weir would reach its modular limit when the head on the Larinier reached 0.6 m (i.e., it would remain modular throughout the design flow range).

Critical dimensions are given in *Table 4.2*. These are prototype values based upon the half-scale model.

## **7.2.4 Study D. Fundamental requirements for the near-crest arrangements of baffles on the downstream face of a measuring weir (Chapter 5)**

### **7.2.4.1 Scope**

Research on 'Hurn'-type easements in the form of baffles on the downstream face of a triangular profile weir is ongoing, but the concept is judged to have promise because the baffle system can be fitted to existing weirs and the adaptation is relatively inexpensive.

One important design requirement is to know the minimum acceptable distance from the crest of the weir for the most upstream baffle. Fisheries interests would like this baffle as close as possible to the crest, to minimise velocities during the final stages of fish ascent. However, the hydrometric performance of triangular profile weirs is very sensitive to flow conditions close to the crest. A laboratory study was thus undertaken to establish the basic ground rules for the uppermost baffles in the Hurn-type easement arrangement in terms of size and distance from the crest. Chapter 5 describes the tests carried out and the results.

#### **7.2.4.2 Conclusions**

1. The results apply to Crump weirs and centre line conditions on flat-V weirs.
2. The test conditions used in the present investigation are defined in *Figure 5.1* and covered a range of baffle sizes and locations. All baffles had the shape of those currently in use at Hurn.
3. The effects of near-crest baffles are dependent upon the:
  - head over the weir up to which accurate modular flow performance is required,  $H$ ;
  - distance from the crest line to the first baffle,  $L$ ;
  - size (height) of the first baffle,  $T$ .
4. *Figure 5.2* shows the basic test results, which indicate deviations of up to 7 per cent from the basic coefficient of discharge of a Crump weir. *Figure 5.4* presents the basic test results in normalised form.
5. A non-dimensional design chart is given in *Figure 5.5*. This defines those conditions with little or no effect, taken as conditions that exhibit less than 1 per cent reduction from the basic Crump weir coefficient of discharge. It also provides an approximate means to determine the magnitude of the effect of any baffles that do not meet the 'no effect' criterion.

#### **7.2.5 Study E. Laboratory testing of a Larinier fish pass with a submerged orifice upstream intake set alongside a flow measurement structure, non-specific (Chapter 6)**

##### **7.2.5.1 Scope**

One of the planned outputs from this research was to provide a first draft of a standard for combined fish pass–gauging structure installations (see Appendix M). The general arrangement testing was undertaken to confirm suitable design parameters that provide satisfactory gauging structure and fish pass performance.

##### **7.2.5.2 Conclusions**

###### **General**

In general the test facilities, designed according to the methods described in Chapter 2, provided suitable hydrometric and fish migration conditions throughout the design flow range. This observation applies to both series of

tests, that is conditions in which the fish pass is level with the weir (Series A) and conditions in which the fish pass is 0.18 m below weir level (Series B).

### **Flow conditions at the upstream entry to the fish pass**

The question of head losses through the upstream orifice to the fish pass is important because excessive head losses require the use of an additional stage recorder in the fish pass channel so that flows can be calculated (separately) for the fish pass.

The requirements for the upstream entry are that head losses should not significantly degrade flow measurement and that velocities should not be so high as to impede fish movement.

In Series A the upstream entry to the fish pass was through a submerged rectangular orifice with a cross-sectional area of 0.75 m<sup>2</sup>. The average velocities through this orifice would not impede fish movement, being 0.11 m/s at the minimum recommended fish pass head of 0.18 m and 0.68 m/s at the maximum fish pass head of 0.60 m (see *Figure 6.7*). However, head losses through the orifice caused slight concern to the hydrometric interests (see *Figure 6.5*), and it was agreed to increase the size of the orifice to 1.125 m<sup>2</sup> for the Series B tests.

In Series B the average velocities through the enlarged orifice were 0.07 m/s at the minimum recommended fish pass head of 0.18 m, and 0.44 m/s at the maximum fish pass head of 0.60 m (see *Figure 6.12*).

For a given flow through the fish pass, a significant reduction in head loss was observed in Series B, which provided clear justification for the enlarged upstream entry (see *Figures 6.9* and *6.10*). Thus, for a single unit Larinier fish pass the submerged entry orifice should be not less than 1.125 m<sup>2</sup>. For installations with more than one Larinier unit, the size of the orifice should increase proportionately (i.e., 2.25 m<sup>2</sup> for two units, etc.).

### **Flow conditions at the downstream exit from the fish pass**

The requirement for the downstream exit from the fish pass is that it should provide a definable jet of water to which migrating fish would be attracted. Preferably, this jet is to issue immediately downstream of the hydraulic jump formed on the downstream face of the gauging weir.

In both series of tests, at low flows the hydraulic jump formed just upstream of the fish pass exit slot. The hydraulic jump migrated upstream as flows increased, until drowning occurred. This cannot be avoided.

In Series A the average velocities through the downstream exit from the fish pass were 0.33 m/s and 1.04 m/s at the minimum and maximum recommended fish pass flows, respectively (see *Figure 6.7*). The corresponding figures for Series B were 0.41 m/s and 1.27 m/s (see *Figure 6.12*). These results illustrate the difficulty in generating high exit velocities when flows through the fish pass are at the lower end of the range.

### **Flow conditions within the fish pass**

The requirement for flows within the fish pass is that the hydraulic jump, if present, should not occur downstream of the most downstream baffle of the fish pass, and thereby create difficult access for migrating fish.

Water surface profiles through the fish pass for the Series A and Series B tests are shown in *Figures 6.4* and *6.8*. At low flows the tailwater level remains above the most downstream baffle of the fish, and thereby provides suitable conditions for migrating fish. As flows increase, the hydraulic jump moves upstream until the onset of drowning, when sub-critical flow conditions occur throughout the fish pass.

### **Flow conditions within the stilling basin of the measuring weir**

To facilitate fish migration it is important that flow conditions in the stilling basin are sub-critical and that there is little instability in terms of large-scale eddies, which cause orientation problems for migrating fish.

In all the Series A and Series B tests a stable hydraulic jump was formed on the one in five downstream slope of the Crump weir – this downstream slope was chosen by E S Crump because of this particular characteristic. Flows that entered the stilling basin were sub-critical and free of large-scale eddies throughout the flow range for both series of tests.

## **7.3 Recommendations**

### **7.3.1 Flows through fish pass–gauging structure combinations**

The computation of flows using the method demonstrated in this research gives important information, at the design stage, regarding individual flows through each section of a gauging structure and through the fish pass. The method shows how flows over the weir (or individual weir sections in the case of a compound weir) and through the fish pass vary over a range of river flows. Suitable crest levels, breadths, etc., can be determined in accordance with hydrometric and fisheries requirements. The method follows published information in standards. This type of detailed analysis is essential to determine uncertainties in flow measurement (see Section 3).

It is recommended that the Environment Agency commissions software development to provide user-friendly software, for use either by the Environment Agency in-house or by consultants working for the Environment Agency.

### **7.3.2 Uncertainties at fish pass–gauging structure combinations**

The computation of uncertainties using the method demonstrated in this research gives important information regarding the overall uncertainties through gauging structure–fish pass combinations. It shows how uncertainties vary with river flow and enables designers to change parameters, such as crest level, crest breadth or the numbers of fish pass units, etc., in order to

meet the perceived accuracy requirements. The method follows published information in standards.

Again, it is recommended that the Environment Agency commissions software development to provide user-friendly software for use either by the Environment Agency in-house or by consultants working for the Environment Agency.

*Note.* The software should provide a comprehensive, user-friendly method for both flows (Section 7.3.1) and uncertainties (Section 7.3.2) at gauging structure–fish pass combinations over a range of river flows. Future discussions will determine the scope and specification for such software. ‘Basic’ software might be focussed on the Environment Agency’s requirements on weir and fish pass types, with basic user interface, project report, basic manual, no complex graphics, no licence agreements, no on-line help or support, etc. ‘Detailed’ software might be focussed on the Environment Agency’s requirements on weir and fish pass types, designed in a format acceptable to the Environment Agency’s IT Department, with user-friendly interface, comprehensive graphics, full project report, comprehensive manual, pilot testing and online help or maintenance, support and licensing.

### **7.3.3 Accumulation of trash at fish passes**

The study on trash accumulation carried out as part of this research indicates the need for further work in the following areas:

- Information on the trash behaviour at a wider selection of flow measurement structures could be obtained through a questionnaire designed with this purpose in mind, and sent to selected Environment Agency staff with responsibility for hydrometry.
- Research is needed into how best to establish upstream river conditions that would result in trash not passing close to fish pass entrances. The use of fixed bed vanes to impart the optimum secondary circulation in the river should be explored. The same approach could help where excessive bedload sediment is known to block fish passes.
- The effectiveness of floating booms in preventing trash ingress could be improved if more were known about the effect of boom length and location in relation to the inlet size and the position of the neighbouring weir crest, or other river flow structure. Laboratory tests might establish this.
- Guidelines for the design of screens should be drawn up, including the Health and Safety aspects of access for cleaning.

### **7.3.4 Additional hydrometric calibrations of fish passes**

The current research has provided a ‘hydrometric quality’ calibration of a Larinier fish pass with 100 mm baffles. The data will be incorporated in a (first) draft standard as part of the project. The standard will be somewhat limited until further ‘hydrometric quality’ calibrations of alternative fish pass types are available. To start this process it is suggested that a Larinier fish pass with 150 mm baffles should be tested. The aims would be two-fold:

- to provide details of the hydrometric performance of the 150 mm fish pass;
- to determine whether a general formulation can be provided for Larinier fish passes that would provide much more flexibility in design.

This study requires volumetric flow measurement facilities with sufficient capacity to avoid unwanted scale effects, as used in Phase 2 of the Environment Agency research commission SC020053/W6-084.

### **7.3.5 Alternative arrangements of Hurn-type baffles**

This research has provided data that enables the designer to place the most upstream baffle of a Hurn-type arrangement as close to the crest of a triangular profile weir as possible without affecting the hydrometric performance of the weir. The work is limited to the specific shape of baffle tested.

There are many examples of the field installation of baffles on the downstream face, mainly of flat-V weirs, and there is little consistency in the shape of the baffles or the way in which they are arranged in the weir face.

Two further studies are suggested:

- a two-dimensional study similar to the one already undertaken in which different baffle shapes would be tested;
- a three-dimensional study to look at flow patterns when baffles are placed on the downstream face of flat-V weirs and to optimise and standardise the arrangement of the baffles.

These studies require volumetric flow measurement facilities with sufficient capacity to avoid unwanted scale effects, as used in Phase 2 of the Environment Agency research commission W6-084.

### **7.3.6 Review of *Fish Pass Guide***

The *Fish Pass Guide* by Armstrong *et al.* was issued in 2004 by the Environment Agency. There are sections of this guide to which the introduction of the results of the current research would add value. We thus propose a review of the *Fish Pass Guide* with detailed suggestions for changes and additions.

### **7.3.7 Field tests**

There is a need to verify that the findings of this research can be implemented in the field. Members of the Project Board are actively reviewing plans for future capital works and are considering several specific sites. It is suggested that HR Wallingford should be a partner in this work, providing:

- technical inputs at Project Board level;

- computation of flows and uncertainties at the design stage;
- advice on hydrometric issues, as necessary;
- supervision of the evaluation of the hydraulic performance of the field installation.

### **7.3.8 Additional items**

In discussions with the Project Board many ideas have been generated for future research. In no particular order, these include:

- calibration data for pool and traverse fish passes;
- variable size 'Hurn'-type baffles;
- use of Larinier type units on the downstream face of gauging weirs;
- better design criteria for fish pass exits and entrances;
- consideration of the effects of wingwall over-topping;
- drowned flow data for fish passes.

## 8. References

Ackers P and White W R, 1973 *Sediment Transport; A new approach and analysis*. Proceedings of the American Society of Civil Engineers, **99**, 2041-2060.

Ackers P, White W R, Perkins J A and Harrison A J M, 1978 *Weirs and flumes for flow measurement*, 350 pp. Chichester: John Wiley..

Armstrong G, Aprahamian M, Fewings A, Gough P, Reader N and Varallo P, 2004 *Environment Agency Fish Pass Manual, Version 1.1*, p. 176. Bristol: Environment Agency.

BS 3680:Part 4B:1986)/ISO 4360:1984, 1986 *Measurement of liquid flow in open channels. Part 4B. Triangular profile weirs*. London: British Standards Institution.

BS ISO 14139:2000, 2000 *Hydrometric determinations – Flow measurement in open channels Compound gauging structures*. London: British Standards Institution.

BS ISO 4377:2002, 2002 *Hydrometric determinations – Flow measurement in open channels Flat-V weirs*. London: British Standards Institution.

Child S, Woods-Ballard B, Clare-Dalglish A and Sayers P, 2002 *Review of good practices for hydrometry*. Environment Agency Draft Technical Report W6(00)07.

Clough S C and Turnpenny A W H, 2001 *Swimming speeds in fish: Phase 1*. Environment Agency Technical Report W2026/TR1.

International Standards Organisation, 1998 *Measurement of fluid flow – Evaluation of uncertainties*. ISO/TR 5168. Geneva: International Standards Organisation.

Joint National Hydrometry and Fish Pass Group, 2001. *Guidance on the design and construction of Crump and Flat-V gauging weirs in relation to fish passage*. Environment Agency memo.

Larinier M, Porcher J P, and Travade F, 2002 *Fishways: biological basis, design criteria and monitoring*. Bulletin Français de la Pêche et de la Pisciculture, **364**, 208 pp.

National Rivers Authority, 1995 *Hurn weir gauging station: re-appraisal of options to facilitate the upstream migration of Dace*. National Rivers Authority, Project No. C5200.



Phillips G and Clarke C, 2001 *Weirs, flow measurement and fish passage: action on reconciling the conflicts*. Environment Agency memo.

Turnpenny A W H, Struthers G and Hanson K P, 1998 *A UK guide to intake fish-screening regulations, policy and best practice*. ETSU H/06/00052/00/00.

Turnpenny A W H, Blay S R, Carron J J and Clough S C, 2001 *Literature review of swimming speeds of freshwater fish*. Environment Agency R&D Technical Report W2-026/TR1.

Turnpenny A W H, Lawton K and Clough S C, 2002a *Fish passages at flow gauging stations in England and Wales. Stage 1: Literature review and regional survey*. Environment Agency R&D Technical Report W6-029/TR1.

Turnpenny A W H, Lawton K, Clough S C, Hanson K, Ramsay R, Osborne G and Kitson N 2002b. *Fish passage at flow gauging stations in England and Wales. Stage 2: Fish pass physical model evaluation and field studies*. Environment Agency R&D Technical Report W246.

Walters G A, 1996a *Hydraulic model tests on the proposed fish pass structure for Hurn gauging weir, Dorset*. Exeter: Exeter Enterprises Ltd.

Walters G A, 1996b *Hydraulic model tests on the proposed fish pass structure for Hurn gauging weir, Dorset: supplementary report*. Exeter: Exeter Enterprises Ltd.

Walters G A, 1997 *Hydraulic model tests on the proposed fish pass structure for Hurn gauging weir, Dorset: supplementary report no. 2*. Exeter: Exeter Enterprises Ltd.

Washington Department of Fish and Wildlife, 2000 *Fishway guidelines for Washington State, Trash rack and other design details*, <http://www.water.gov/wdfw/hab/ahg/fishguid.pdf>

White W R and Woods-Ballard B A, 2003 *The investigation and specification of flow measurement structure design features that aid the migration of fish without significantly compromising flow measurement accuracy, with the potential to influence the production of suitable British Standards Phase 2*. Environment Agency R&D Technical Report W6-084/TR1.

White W R, Paris E and Bettess R, 1980 *The frictional characteristics of alluvial streams: a new approach*. Proceedings of the Institution of Civil Engineering, Part 2, **69**, 737-750.

White W R, Paris E and Bettess R, 1981 *Tables for the design of stable alluvial channels*. HR Wallingford Report, IT 208.

White W R, Bettess R and Paris E, 1982 *An analytical approach to river regime*. Proceedings of the American Society of Civil Engineers, **108**, 1179-1193.

White W R, Bettess R and Wang Shiqiang, 1987 *Frictional characteristics of alluvial streams in the lower and upper regimes*. Proceedings of the Institution of Civil Engineering, Part 2, **83**, 685-700.

# Appendices

## Appendix A

Source of average flow and flow exceedence data for UK rivers

### A.1 Data used to determine average 5% and 10% ADF

#### Anglian Region

Station No.	Station name	River name	Gauging structure	Weir width (m)	5% ADF as percentiles	10% ADF as percentiles
33033	Arlesey	Hiz	Crump	7	99.06	98.12
29005	Bishopbridge	Rase	Crump	3.658	98.17	96.33
31016	Empingham	North Brook	Crump	2.36	99.14	98.29
30013	Heighington	Heighington Brook	Crump	3.51	98.38	96.75
29003	Louth	Lud	Crump	4.569	99.06	98.13
30004	Partney Mill	Lymn	Crump	5	99.11	98.21
30014	Pointon	Pointon Lode	Crump	2.445	92.12	88.08
31022	Harborough	Jordan	Crump	1.47	90.26	83.16
31007	Barrowden	Welland	Crump	3.04	97.36	94.25
31006	Belmesthorpe	Gwash	Crump	8.5	99.32	98.64
32008	Dodford	Nene/Kisling Brook	Crump	2.667	98.61	97.23
32019	Kettering	Slade Brook	Crump	2.42	98.67	97.33
33022	Blunham	Ivel	Crump	7.31	99.32	98.64
33061	Fowlmere One	Shep	Crump	1.1	99.17	98.33
33052	Swaffham Bulbeck	Swaffham	Crump	2.5	99.33	98.67
33023	Beck Bridge	Lea Brook	Crump	4	96.88	92.95
31025	Manton	Gwash S Arm	Flat V	5*	95.25	84.88

3102 6	Egleton	Egleton Brook	Flat V	2	95.00	90.00
3200 4	Harrowden Mill	Ise Brook	Flat V	5.94*	98.30	96.60
2900 9	Toft Newton	Ancholme	Flat V	3.03	89.49	83.06
3001 7	Colsterworth	Witham	Flat V	4.996*	97.00	93.20
3102 3	Easton Wood	West Glen	Flat V	8.05	95.00	93.13
3305 8	Bletchley	Ouzel	Flat V	10	99.06	98.12
3102 1	Ashley	Welland	crump + broad crested flanks	6.97	97.67	95.35
2900 2	Claythorpe Mill	Great Eau	crump + broad crested flanks	9.687	99.39	98.79
3102 4	Holywell	Holywell Brook	crump + broad crested flanks	2.498	97.00	93.88
3200 3	Old Mill Bridge	Harpers Brook	Compound Crump	3.657	98.54	97.07
2900 4	Bishopbridge	Ancholme	Compound Crump	9.131	94.06	90.63
3101 0	Fosters Bridge	Chater	Compound Crump	6.077	97.88	95.75
3306 6	Linton	Granta	Compound crump	5.3	90.70	85.90

\* Sites used in Appendix B

## Midlands Region

Station No.	Station name	River Name	Gauging structure	Weir range (m)	5% ADF as percentiles	10% ADF as percentiles
4046	Izaak Walton	Dove	Flat V	8	99.72	99.44
4061	Basford Bridge	Churnet	Flat V	8-12*	99.73	99.46
4067	Church Wilne	Derwent	Flat V	21*	99.77	99.54
4066	Coleshill	Cole	Flat V	8-10*	99.67	99.35
4055	Duffield	Ecclesbourne	Flat V	5-8	99.51	99.01
4052	Great Bridgford	Sow	Flat V	7-10*	99.77	99.53
4018	Marston on Dove	Dove	Flat V	22-23*	99.52	99.04
4056	Rothley	Rothley Brook	Flat V	6-8	99.51	99.02
4079	Shallowford	Meece	Flat V	3-6	99.63	99.27
4023	Ashford	Wye	Flat V	10*	99.74	99.48
4058	Ashbourne	Henmore Brook	Flat V	3-5	99.42	98.20
4050	Auckley	Torne	Flat V	4-5*	99.82	99.63
2015	Besford Bridge	Bow Brook	Flat V	4	97.94	94.35
4047	Blyth	Oldcotes Dyke	Flat V	6-7	99.82	99.64
2607	Bromsberrow	Glynch Brook	Flat V	3	94.45	89.90
2109	Bryntail	Afon Clywedog	Flat V	16	99.42	93.69
2603	Cambridge	Cam	Flat V	5-6*	99.81	99.63
2148	Cannop Cross	Cannop Brook	Flat V	2	99.53	99.05
2149	Cownwy Weir	Cownwy	Flat V	15	96.75	89.44
2011	Harford Hill	Salwarpe	Flat V	7	99.70	99.40
2061	Hodnet	Hodnet	Flat V	1-3	86.40	37.00
2038	Llanyblodwel	Tanat	Flat V	12-15	98.57	91.81
4060	Lowdham	Dover Beck	Flat V	4-5*	99.79	99.59
4115	Mansfield the Dykes	Maun	Flat V	5*	99.91	99.81
2034	Oak Cottage	Dowles Brook	Flat V	5*	98.20	91.22
2023	Offenham	Badsey Brook	Flat V	5*	99.33	96.20
4053	Penkridge	Penk	Flat V	6-8	99.49	98.89
4118	Perlethorpe	Meden	Flat V	7	99.85	99.70
2045	Perry Farm	Perry	Flat V	5*	99.78	99.56
2063	Prestwood	Stour	Flat V	11*	99.83	99.65
4076	Rolleston	Rolleston	Flat V	3.5-5	99.68	99.35
2060	Sandyford Bridge	Potford Brook	Flat V	1.5-2	99.75	99.49
4072	Southwell	Greet	Flat V	4.5-6*	98.14	97.28
2062	Stoke	Stoke Brook	Flat V	5*	99.76	99.52
2012	Walcot	Tern	Flat V	20*	99.68	99.36
2193	Wards Bridge	Hadley Brook	Flat V	2.5-3.5	99.64	99.28

Station No.	Station name	River Name	Gauging structure	Weir range (m)	5% ADF as percentiles	10% ADF as percentiles
2048	Wellesbourne	Dene	Flat V	3-7	99.30	94.58
4117	Whatstandwell	Derwent	Flat V	25	99.75	99.51
4116	Whitewater Bridge	Maun	Flat V	5*	99.87	99.73
2602	Whitleyford Bridge	Lonco Brook	Flat V	3	99.49	98.89
2066	Platt	Platt Brook	Flat V	1-3	99.74	99.47
4049	Worksop	Ryton	Flat V	3.9-4.5	99.59	99.18
2104	Broom	Arrow	Simple Crump	9-12*	99.79	99.58
2024	Burcote	Worfe	Simple Crump	5-8	99.69	99.39
4039	Calthorpe Park	Rea	Simple Crump	3-4	99.79	99.58
4044	Cuckney	Poulter	Simple Crump	2-4.5	99.87	99.75
2041	Eaton-on-Tern	Tern	Simple Crump	8	99.83	99.67
2036	Hinton	Isbourne	Simple Crump	3-5	99.29	96.99
4031	Ilam	Manifold	Simple Crump	15-18	99.58	99.17
4080	Lea Marston Lakes	Tame	Simple Crump	10-12	99.90	99.80
2124	Parkend	Cannop Brook	Simple Crump	2-5	99.58	99.16
4026	Polesworth	Anker	Simple Crump	12-18	99.67	99.35
2019	Starton	Avon	Simple Crump	7-9	99.65	99.30
4040	Stoke-on-Trent	Trent	Simple Crump	4-5*	99.66	99.31
2040	Tibberton	Meese	Simple Crump	6	99.82	99.65
4003	Water Orton	Tame	Simple Crump	8	99.51	99.01
2020	Yeaton	Perry	Simple Crump	6-9	99.74	99.49

\* Sites used in Appendix B

## A.2 Data used to determine average percentage flow exceedence at the modular limit

EA Region	Station No.	Station name	River name	Gauging structure	Weir width (m)	Qmod limit
Anglian	33033	Arlesey	Hiz	Crump	7	6.30
Anglian	29005	Bishopbridge	Rase	Crump	3.658	6.08
Anglian	31007	Barrowden	Welland	Crump	3.04	5.04
Anglian	33061	Fowlmere One	Shep	Crump	1.1	9.44
Thames	37018	Gaynes Park	Ingrebourne	Flat V Crump	9.5	7.77
Thames	39025	Brimpton	Enborne	Asymmetrical Compound Crump	3m & 4.6m	7.41
Wales	67015	Manley Hall	Dee	Asymmetrical Compound Crump	Not given	7.83

## A.3 Additional raw data

### Thames Region

Station No.	Station name	River Name	Gauging structure	Weir width (m)	Qmod limit
1029	Burton on the Water	Dickler	Dickler	5.953	3
1420	Banbury	Cherwell	Cherwell	Main Weir 8.990; Side Weir 3.080	12
1437	Bodicote	Sor Brook	Sor Brook	5.000	0
1471	Grendon Underwood	Ray Oxon	Ray Oxon	4.539	15
1751	Arabellas Lake	Letcombe Brook	Letcombe Brook	1.501	N/A
1790	Abingdon New Weir	Ock	Ock	7.792	10
190	Cricklade	Thames	Thames	High Crest 4.500; Low Crest 2.400	35
2140	Frilsham	Pang	Pang	4.006	7
2150	Bucklebury	Pang	Pang	4.004	30
2190	Pangbourne	Pang	Pang	3.975	2
2195	Sulham	Sulham Brook	Sulham Brook	3.402	60
2219	Marlborough (Poulton)	Og	Og	3.040	0

Station No.	Station name	River Name	Gauging structure	Weir width (m)	Qmod limit
	Farm)				
2229	Ramsbury	Aldbourne	Aldbourne	3.990 (Main)	75
2230	Knighton	Kennet	Kennet	13.728 (Main)	47
2239	Hungerford	Dun	Dun	10.731	N/A
2241	Hungerford	Shalbourne	Shalbourne	2.997	0
2264	Bagnor	Winterbourne Stream	Winterbourne Stream	3.004	3
2275	Kingsclere	Kingsclere Brook	Kingsclere Brook	3.502	0.1
2279	Brimpton	Enbourne	Enbourne	Low Crest 3.054; High Crest 4.574	0.1
2290	Theale	Kennet	Kennet	16.771	15
250	Parrotts Brook	Churn	Churn	6.002	80
2550	High Wycombe	Wye	Wye	5.601	12
2569	Wycombe	Hughendon Stream	Hughendon Stream	2.509	70
260	Cirencester	Churn	Churn	4.492	27-0.1
490	Sheepen Bridge	Ampney Brook	Ampney Brook	4.480	1
530	Whetstone Bridge	Marston Meysey Brook	Marston Meysey Brook	2.995	10
630	Fossebridge	Coln	Coln	7.833	1-0
790	Inglesham	Ole	Ole	Left Crest 3.033; Middle Crest 2.800; Right Crest 3.018	60
890	Lechlade	Leach	Leach	4.489	20
2815	Redbourne	Ver	Ver	3.995	50
2816	Redbourne	Red	Red	4.002	80
2859	Rickmansworth	Chess	Chess	5.995	2
2879	Denham	Misbourne	Misbourne	3.500	0
2895	Staines Moor	Wraysbury	Wraysbury	5.500	2-0.3
2896	Staines (Pond Mill)	Wraysbury	Wraysbury	4.326	3
3829	Colindale (Colindeep Lane)	Silk Stream	Silk Stream	8.485	0.1
4770	Welwyn (Fulling Mill)	Mimram	Mimram	3.010	5
4827	Bragbury Park	Stevenage Brook	Stevenage Brook	2.754	0.05



Station No.	Station name	River Name	Gauging structure	Weir width (m)	Qmod limit
5357	Lower Edmonton	Salmons Brook	Salmons Brook	4.700	0
2442	North Warnborough (Lodge Farm)	Whitewater	Whitewater	2.762	92
2458	Bramshill	Hart	Hart	4.001	96
2469	Swallowfield	Blackwater	Blackwater	4.575 (main)	12
3010	Alton Town	Wey North	Wey North	2.494	0
3015	Alton	Caker Stream	Caker Stream	2.980	2
3020	Farnham	Wey North	Wey North	8.840	0
3040	Tilford	Wey	Wey	12.000	15 (80-4)
3079	Shalford	Tillingbourne	Tillingbourne	5.495	8
3270	Dorking (Castle Mill)	Mole	Mole	15.191	55

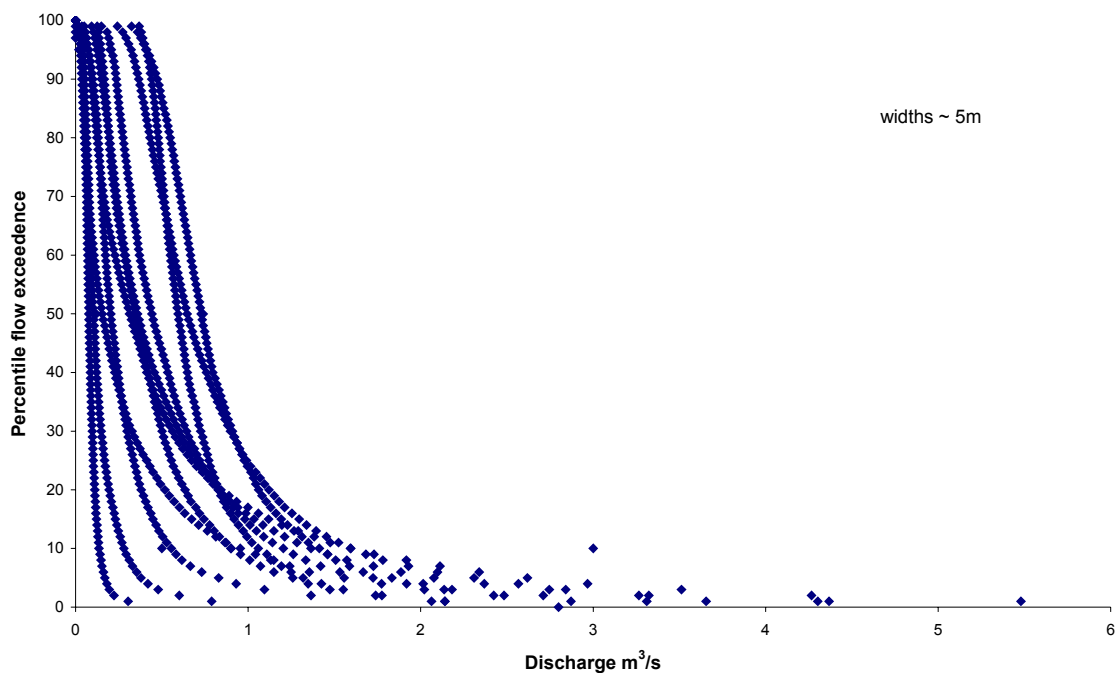
### Southern Region

Station No.	Station name	River Name	Gauging structure	Weir width (m)	Qmod limit
2001	Frog Mill	Hamble	Crump weir	3.050	18
3002	West Meon/Hall Place	Meon	Flat v	1987 = 5.60; 1994 = 2.5	11
7001	Ower	Blackwater	Crump weir	6.160	6
9001	North Fareham	Wallington	Flat v	5.940	1
8202	Highbridge	Itchen	Crump weir	7.750	n/a

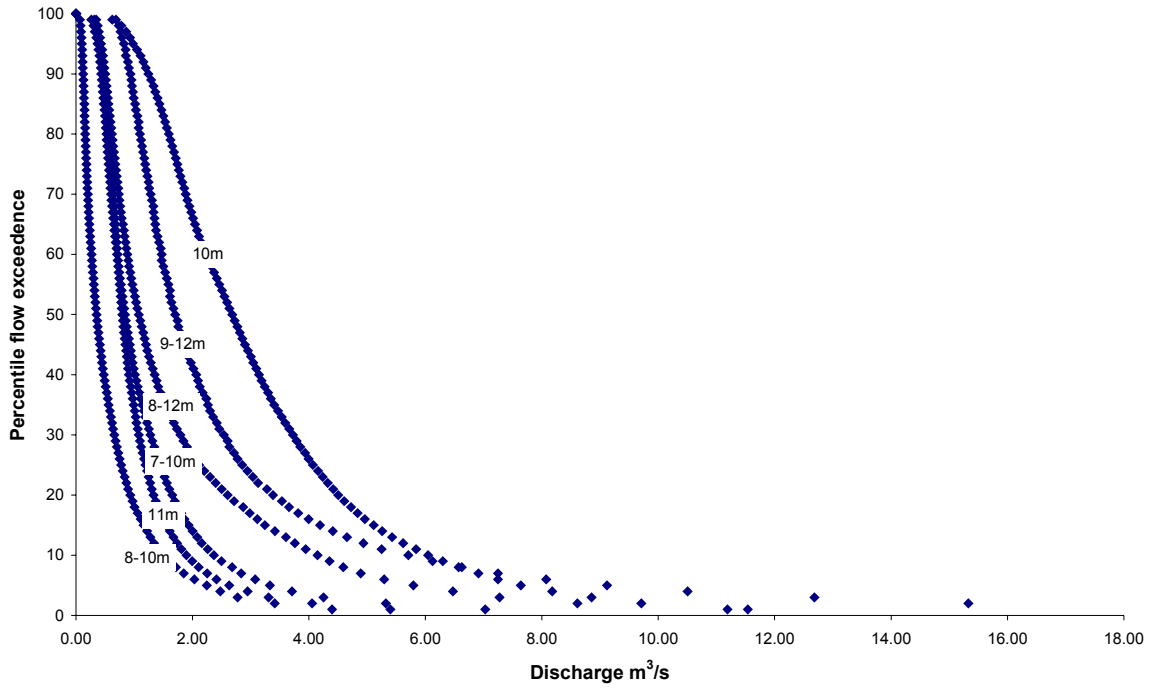
# Appendix B

Typical flow exceedence curves for rivers of 5m, 10m and 20m width

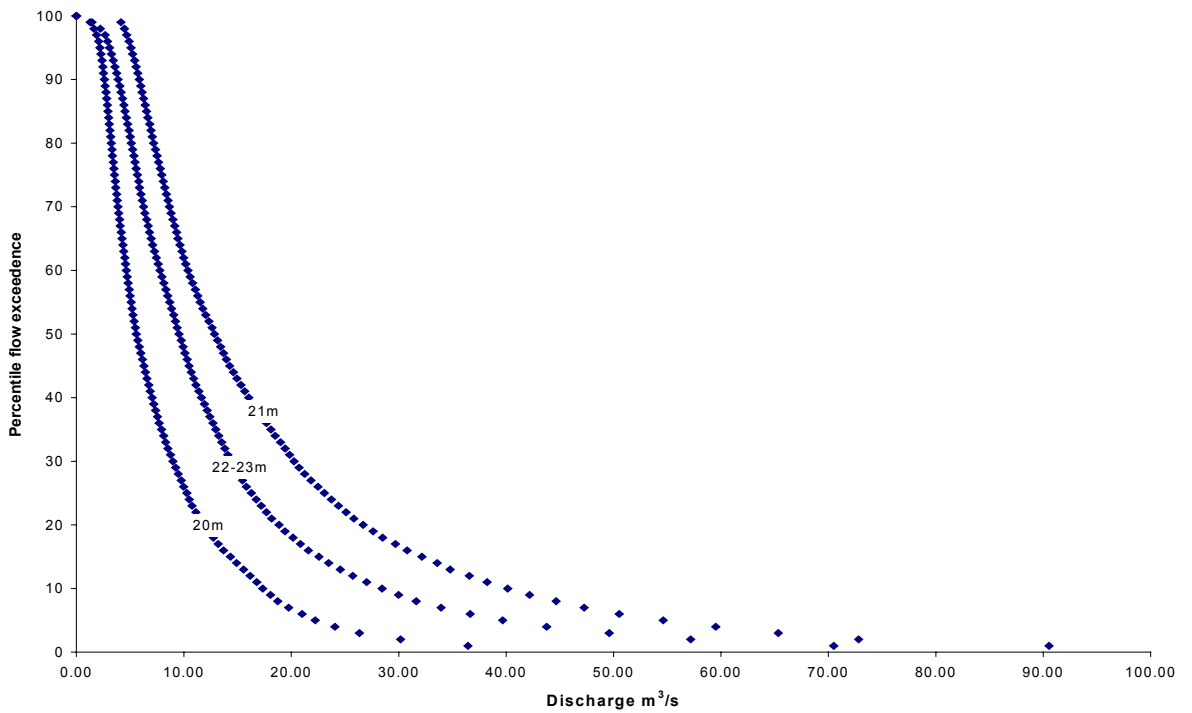
The percentile flows for the sites listed in Appendix A1 are plotted against percentile flow exceedence for weirs located in 5m, 10m and 20m river widths in Figures B1, B2 and B3 below. Figure B1 includes both Midlands and Anglian data, and Figures B2 and B3 are based on Midlands data only (see '\*' in Appendix A1 for identification of sites used). Due to the scatter of the data, no available best-fit approach in Microsoft Excel provides a reasonable  $R^2$  correlation.



**Figure B.1 Relationship between discharge and percentage flow exceedence for 5m river widths**



**Figure B.2 Relationship between discharge and percentage flow exceedence for 10m river widths**



**Figure B.3 Relationship between discharge and percentage flow exceedence for 20m river widths**

## Appendix C

### Summary of flows through gauging structure / fishpass combinations

Head relative to low weir (m)	Total flow (cumeecs)	Low weir flow (cumeecs)	High weir flow (cumeecs)	Fishpass flow (cumeecs)	Drowned flow reduction DFRF	Weir to Total flows	Fishpass to Total flows
<b>Case 1A</b>							
0.010	0.010	0.009		0.001	1.000	0.900	0.100
0.020	0.030	0.027		0.003	1.000	0.900	0.100
0.030	0.056	0.051		0.005	1.000	0.911	0.089
0.040	0.087	0.079		0.008	1.000	0.908	0.092
0.050	0.123	0.111		0.012	1.000	0.902	0.098
0.060	0.161	0.146		0.015	1.000	0.907	0.093
0.070	0.204	0.185		0.019	1.000	0.907	0.093
0.080	0.250	0.226		0.024	1.000	0.904	0.096
0.090	0.300	0.271		0.029	1.000	0.903	0.097
0.100	0.353	0.319		0.034	1.000	0.904	0.096
0.110	0.408	0.369		0.039	1.000	0.904	0.096
0.120	0.467	0.422		0.045	1.000	0.904	0.096
0.130	0.527	0.477		0.050	1.000	0.905	0.095
0.140	0.592	0.535		0.057	1.000	0.904	0.096
0.150	0.658	0.595		0.063	1.000	0.904	0.096
0.160	0.728	0.658		0.070	1.000	0.904	0.096
0.170	0.800	0.723		0.077	1.000	0.904	0.096
0.180	0.874	0.790		0.084	1.000	0.904	0.096
0.190	0.956	0.864		0.092	1.000	0.904	0.096
0.200	1.036	0.937		0.099	1.000	0.904	0.096
0.210	1.119	1.012		0.107	1.000	0.904	0.096
0.220	1.191	1.077		0.114	0.989	0.904	0.096
0.230	1.260	1.139		0.121	0.978	0.904	0.096
0.240	1.329	1.201		0.128	0.966	0.904	0.096
0.250	1.394	1.261		0.133	0.952	0.905	0.095
0.260	1.459	1.319		0.140	0.938	0.904	0.096
0.270	1.514	1.369		0.145	0.920	0.904	0.096
0.280	1.575	1.424		0.151	0.906	0.904	0.096
0.290	1.623	1.468		0.155	0.887	0.904	0.096
0.300	1.672	1.511		0.161	0.867	0.904	0.096
0.310	1.731	1.566		0.165	0.856	0.905	0.095
0.320	1.752	1.582		0.170	0.825	0.903	0.097
0.330	1.820	1.646		0.174	0.819	0.904	0.096
0.340	1.868	1.689		0.179	0.805	0.904	0.096
0.350	1.903	1.720		0.183	0.784	0.904	0.096
0.360	1.955	1.767		0.188	0.773	0.904	0.096
0.370	2.002	1.810		0.192	0.762	0.904	0.096
0.380	2.064	1.868		0.196	0.756	0.905	0.095
0.390	2.123	1.922		0.201	0.745	0.905	0.095
0.400	2.151	1.945		0.206	0.729	0.904	0.096

0.410	2.199	1.989		0.210	0.719	0.905	0.095
0.420	2.256	2.042		0.214	0.712	0.905	0.095
0.430	2.325	2.100		0.225	0.707	0.903	0.097

---

**Case 1B**

-0.170	0.001	0.000		0.001	1.000	0.000	1.000
-0.160	0.003	0.000		0.003	1.000	0.000	1.000
-0.150	0.005	0.000		0.005	1.000	0.000	1.000
-0.140	0.008	0.000		0.008	1.000	0.000	1.000

---

Head relative to low weir (m)	Total flow (cumecs)	Low weir flow (cumecs)	High weir flow (cumecs)	Fishpass flow (cumecs)	Drowned flow reduction DFRF	Weir to Total flows	Fishpass to Total flows
--	------------------------	------------------------------	-------------------------------	------------------------------	--------------------------------------	---------------------------	-------------------------------

---

-0.130	0.012	0.000		0.012	1.000	0.000	1.000
-0.120	0.015	0.000		0.015	1.000	0.000	1.000
-0.110	0.019	0.000		0.019	1.000	0.000	1.000
-0.100	0.024	0.000		0.024	1.000	0.000	1.000
-0.090	0.028	0.000		0.028	1.000	0.000	1.000
-0.080	0.033	0.000		0.033	1.000	0.000	1.000
-0.070	0.038	0.000		0.038	1.000	0.000	1.000
-0.060	0.044	0.000		0.044	1.000	0.000	1.000
-0.050	0.049	0.000		0.049	1.000	0.000	1.000
-0.040	0.055	0.000		0.055	1.000	0.000	1.000
-0.030	0.061	0.000		0.061	1.000	0.000	1.000
-0.020	0.067	0.000		0.067	1.000	0.000	1.000
-0.010	0.074	0.000		0.074	1.000	0.000	1.000
0.000	0.080	0.000		0.080	1.000	0.000	1.000
0.010	0.096	0.009		0.087	1.000	0.094	0.906
0.020	0.121	0.027		0.094	1.000	0.223	0.777
0.030	0.152	0.051		0.101	1.000	0.336	0.664
0.040	0.187	0.079		0.108	1.000	0.422	0.578
0.050	0.227	0.111		0.116	1.000	0.489	0.511
0.060	0.270	0.146		0.124	1.000	0.541	0.459
0.070	0.316	0.185		0.131	1.000	0.585	0.415
0.080	0.365	0.226		0.139	1.000	0.619	0.381
0.090	0.419	0.271		0.148	1.000	0.647	0.353
0.100	0.476	0.319		0.157	1.000	0.670	0.330
0.110	0.530	0.369		0.161	1.000	0.696	0.304
0.120	0.587	0.422		0.165	1.000	0.719	0.281
0.130	0.647	0.478		0.169	1.000	0.739	0.261
0.140	0.709	0.536		0.173	1.000	0.756	0.244
0.150	0.775	0.597		0.178	1.000	0.770	0.230
0.160	0.842	0.660		0.182	0.986	0.784	0.216
0.170	0.912	0.726		0.186	0.976	0.796	0.204
0.180	0.984	0.794		0.190	0.963	0.807	0.193
0.190	1.058	0.864		0.194	0.946	0.817	0.183
0.200	1.115	0.916		0.199	0.933	0.822	0.178
0.210	1.177	0.974		0.203	0.914	0.828	0.172
0.220	1.240	1.033		0.207	0.894	0.833	0.167

0.230	1.298	1.087		0.211	0.865	0.837	0.163
0.240	1.361	1.146		0.215	0.811	0.842	0.158
0.250	1.427	1.207		0.220	0.760	0.846	0.154
0.260	1.481	1.257		0.224	0.712	0.849	0.151

---

**Case 2A**

0.010	0.001	0.000		0.001	1.000	0.000	1.000
0.020	0.004	0.001		0.003	1.000	0.250	0.750
0.030	0.007	0.002		0.005	1.000	0.286	0.714
0.040	0.013	0.005		0.008	1.000	0.385	0.615
0.050	0.019	0.008		0.011	1.000	0.421	0.579
0.060	0.028	0.013		0.015	1.000	0.464	0.536
0.070	0.038	0.019		0.019	1.000	0.500	0.500
0.080	0.050	0.027		0.023	1.000	0.540	0.460
0.090	0.065	0.037		0.028	1.000	0.569	0.431
0.100	0.081	0.048		0.033	1.000	0.593	0.407
0.110	0.099	0.061		0.038	1.000	0.616	0.384
0.120	0.119	0.076		0.043	1.000	0.639	0.361
0.130	0.142	0.093		0.049	1.000	0.655	0.345

---

Head relative to low weir (m)	Total flow (cumecs)	Low weir flow (cumecs)	High weir flow (cumecs)	Fishpass flow (cumecs)	Drowned flow reduction DFRF	Weir to Total flows	Fishpass to Total flows
--	------------------------	------------------------------	-------------------------------	------------------------------	--------------------------------------	---------------------------	-------------------------------

---

0.140	0.166	0.112		0.054	1.000	0.675	0.325
0.150	0.194	0.133		0.061	1.000	0.686	0.314
0.160	0.224	0.157		0.067	1.000	0.701	0.299
0.170	0.257	0.183		0.074	1.000	0.712	0.288
0.180	0.292	0.212		0.080	1.000	0.726	0.274
0.190	0.330	0.243		0.087	1.000	0.736	0.264
0.200	0.371	0.277		0.094	1.000	0.747	0.253
0.210	0.414	0.313		0.101	1.000	0.756	0.244
0.220	0.462	0.353		0.109	1.000	0.764	0.236
0.230	0.512	0.395		0.117	1.000	0.771	0.229
0.240	0.565	0.441		0.124	1.000	0.781	0.219
0.250	0.627	0.494		0.133	1.000	0.788	0.212
0.260	0.688	0.547		0.141	1.000	0.795	0.205
0.270	0.756	0.606		0.150	1.000	0.802	0.198
0.280	0.823	0.664		0.159	1.000	0.807	0.193
0.290	0.893	0.725		0.168	1.000	0.812	0.188
0.300	0.965	0.788		0.177	1.000	0.817	0.183
0.310	1.036	0.849		0.187	0.995	0.819	0.181
0.320	1.100	0.907		0.193	0.985	0.825	0.175
0.330	1.166	0.965		0.201	0.975	0.828	0.172
0.340	1.232	1.022		0.210	0.964	0.830	0.170
0.350	1.294	1.077		0.217	0.951	0.832	0.168
0.360	1.357	1.132		0.225	0.938	0.834	0.166
0.370	1.416	1.184		0.232	0.923	0.836	0.164
0.380	1.474	1.234		0.240	0.908	0.837	0.163
0.390	1.530	1.284		0.246	0.893	0.839	0.161

0.400	1.582	1.329		0.253	0.876	0.840	0.160
0.410	1.637	1.381		0.256	0.864	0.844	0.156
0.420	1.688	1.429		0.259	0.851	0.847	0.153
0.430	1.729	1.467		0.262	0.832	0.848	0.152
0.440	1.789	1.524		0.265	0.824	0.852	0.148
0.450	1.838	1.570		0.268	0.811	0.854	0.146
0.460	1.897	1.626		0.271	0.803	0.857	0.143
0.470	1.950	1.676		0.274	0.792	0.859	0.141
0.480	2.012	1.735		0.277	0.786	0.862	0.138
0.490	2.073	1.793		0.280	0.779	0.865	0.135
0.500	2.130	1.847		0.283	0.772	0.867	0.133
0.510	2.191	1.905		0.286	0.765	0.869	0.131
0.520	2.244	1.953		0.291	0.756	0.870	0.130
0.530	2.300	2.010		0.290	0.749	0.874	0.126
0.540	2.343	2.055		0.288	0.739	0.877	0.123
0.550	2.397	2.104		0.293	0.730	0.878	0.122
0.560	2.441	2.150		0.291	0.721	0.881	0.119
0.570	2.525	2.222		0.303	0.721	0.880	0.120
0.580	2.566	2.265		0.301	0.711	0.883	0.117
0.590	2.611	2.312		0.299	0.702	0.885	0.115
0.600	2.699	2.387		0.312	0.703	0.884	0.116

---

**Case 3A**

0.010	0.002	0.000		0.002	1.000	0.000	1.000
0.020	0.007	0.001		0.006	1.000	0.143	0.857
0.030	0.012	0.002		0.010	1.000	0.167	0.833
0.040	0.021	0.005		0.016	1.000	0.238	0.762
0.050	0.031	0.008		0.023	1.000	0.258	0.742
0.060	0.043	0.013		0.030	1.000	0.302	0.698

Head relative to low weir (m)	Total flow (cumecs)	Low weir flow (cumecs)	High weir flow (cumecs)	Fishpass flow (cumecs)	Drowned flow reduction DFRF	Weir to Total flows	Fishpass to Total flows
--	------------------------	------------------------------	-------------------------------	------------------------------	--------------------------------------	---------------------------	-------------------------------

0.070	0.057	0.019		0.038	1.000	0.333	0.667
0.080	0.074	0.027		0.047	1.000	0.365	0.635
0.090	0.093	0.037		0.056	1.000	0.398	0.602
0.100	0.113	0.048		0.065	1.000	0.425	0.575
0.110	0.137	0.061		0.076	1.000	0.445	0.555
0.120	0.162	0.076		0.086	1.000	0.469	0.531
0.130	0.190	0.093		0.097	1.000	0.489	0.511
0.140	0.220	0.111		0.109	1.000	0.505	0.495
0.150	0.254	0.133		0.121	1.000	0.524	0.476
0.160	0.289	0.156		0.133	1.000	0.540	0.460
0.170	0.328	0.182		0.146	1.000	0.555	0.445
0.180	0.369	0.210		0.159	1.000	0.569	0.431
0.190	0.413	0.240		0.173	1.000	0.581	0.419
0.200	0.461	0.274		0.187	1.000	0.594	0.406
0.210	0.510	0.309		0.201	1.000	0.606	0.394
0.220	0.563	0.348		0.215	1.000	0.618	0.382

0.230	0.621	0.389		0.232	1.000	0.626	0.374
0.240	0.680	0.433		0.247	1.000	0.637	0.363
0.250	0.743	0.480		0.263	1.000	0.646	0.354
0.260	0.809	0.530		0.279	1.000	0.655	0.345
0.270	0.878	0.583		0.295	1.000	0.664	0.336
0.280	0.950	0.639		0.311	1.000	0.673	0.327
0.290	1.026	0.698		0.328	1.000	0.680	0.320
0.300	1.106	0.761		0.345	1.000	0.688	0.312
0.310	1.190	0.827		0.363	1.000	0.695	0.305
0.320	1.276	0.896		0.380	1.000	0.702	0.298
0.330	1.369	0.969		0.400	1.000	0.708	0.292
0.340	1.463	1.045		0.418	1.000	0.714	0.286
0.350	1.562	1.125		0.437	1.000	0.720	0.280
0.360	1.664	1.208		0.456	1.000	0.726	0.274
0.370	1.771	1.296		0.475	1.000	0.732	0.268
0.380	1.883	1.387		0.496	1.000	0.737	0.263
0.390	1.998	1.482		0.516	1.000	0.742	0.258
0.400	2.117	1.581		0.536	1.000	0.747	0.253
0.410	2.242	1.684		0.558	1.000	0.751	0.249
0.420	2.370	1.792		0.578	1.000	0.756	0.244
0.430	2.502	1.903		0.599	1.000	0.761	0.239
0.440	2.641	2.019		0.622	1.000	0.764	0.236
0.450	2.783	2.140		0.643	1.000	0.769	0.231
0.460	2.929	2.265		0.664	1.000	0.773	0.227
0.470	3.082	2.394		0.688	1.000	0.777	0.223
0.480	3.239	2.529		0.710	1.000	0.781	0.219
0.490	3.402	2.668		0.734	1.000	0.784	0.216
0.500	3.577	2.821		0.756	0.995	0.789	0.211
0.510	3.728	2.947		0.781	0.988	0.791	0.209
0.520	3.877	3.073		0.804	0.980	0.793	0.207
0.530	4.029	3.212		0.817	0.974	0.797	0.203
0.540	4.171	3.335		0.836	0.967	0.800	0.200
0.550	4.319	3.462		0.857	0.958	0.802	0.198
0.560	4.467	3.591		0.876	0.950	0.804	0.196
0.570	4.615	3.719		0.896	0.942	0.806	0.194
0.580	4.754	3.840		0.914	0.932	0.808	0.192
0.590	4.900	3.966		0.934	0.922	0.809	0.191
0.600	5.031	4.080		0.951	0.911	0.811	0.189
0.610	5.158	4.201		0.957	0.902	0.814	0.186
Head relative to low weir (m)	Total flow (cumecs)	Low weir flow (cumecs)	High weir flow (cumecs)	Fishpass flow (cumecs)	Drowned flow reduction DFRF	Weir to Total flows	Fishpass to Total flows
0.620	5.266	4.302		0.964	0.889	0.817	0.183
0.630	5.391	4.421		0.970	0.880	0.820	0.180
0.640	5.495	4.518		0.977	0.867	0.822	0.178
0.650	5.613	4.630		0.983	0.858	0.825	0.175
0.660	5.730	4.740		0.990	0.848	0.827	0.173
0.670	5.843	4.847		0.996	0.838	0.830	0.170



0.680	5.954	4.951	1.003	0.828	0.832	0.168
0.690	6.062	5.053	1.009	0.818	0.834	0.166
0.700	6.197	5.181	1.016	0.812	0.836	0.164
0.710	6.305	5.283	1.022	0.802	0.838	0.162
0.720	6.467	5.438	1.029	0.800	0.841	0.159
0.730	6.619	5.584	1.035	0.797	0.844	0.156
0.740	6.751	5.709	1.042	0.791	0.846	0.154
0.750	6.867	5.819	1.048	0.783	0.847	0.153
0.760	7.004	5.949	1.055	0.778	0.849	0.151
0.770	7.105	6.044	1.061	0.768	0.851	0.149
0.780	7.240	6.172	1.068	0.763	0.852	0.148
0.790	7.365	6.291	1.074	0.757	0.854	0.146
0.800	7.499	6.419	1.080	0.752	0.856	0.144
0.810	7.606	6.530	1.076	0.745	0.859	0.141
0.820	7.732	6.643	1.089	0.739	0.859	0.141
0.830	7.849	6.764	1.085	0.733	0.862	0.138
0.840	7.952	6.872	1.080	0.727	0.864	0.136
0.850	8.069	6.976	1.093	0.720	0.865	0.135
0.860	8.163	7.074	1.089	0.713	0.867	0.133
0.870	8.352	7.252	1.100	0.714	0.868	0.132
0.880	8.438	7.343	1.095	0.706	0.870	0.130

---

**Case 3B**

-0.170	0.002	0.000	0.002	1.000	0.000	1.000
-0.160	0.006	0.000	0.006	1.000	0.000	1.000
-0.150	0.011	0.000	0.011	1.000	0.000	1.000
-0.140	0.017	0.000	0.017	1.000	0.000	1.000
-0.130	0.023	0.000	0.023	1.000	0.000	1.000
-0.120	0.031	0.000	0.031	1.000	0.000	1.000
-0.110	0.039	0.000	0.039	1.000	0.000	1.000
-0.100	0.048	0.000	0.048	1.000	0.000	1.000
-0.090	0.057	0.000	0.057	1.000	0.000	1.000
-0.080	0.066	0.000	0.066	1.000	0.000	1.000
-0.070	0.077	0.000	0.077	1.000	0.000	1.000
-0.060	0.087	0.000	0.087	1.000	0.000	1.000
-0.050	0.099	0.000	0.099	1.000	0.000	1.000
-0.040	0.110	0.000	0.110	1.000	0.000	1.000
-0.030	0.122	0.000	0.122	1.000	0.000	1.000
-0.020	0.134	0.000	0.134	1.000	0.000	1.000
-0.010	0.147	0.000	0.147	1.000	0.000	1.000
0.000	0.160	0.000	0.160	1.000	0.000	1.000
0.010	0.173	0.000	0.173	1.000	0.000	1.000
0.020	0.188	0.001	0.187	1.000	0.005	0.995
0.030	0.203	0.002	0.201	1.000	0.010	0.990
0.040	0.220	0.005	0.215	1.000	0.023	0.977
0.050	0.238	0.008	0.230	1.000	0.034	0.966
0.060	0.259	0.013	0.246	1.000	0.050	0.950
0.070	0.280	0.019	0.261	1.000	0.068	0.932
0.080	0.304	0.027	0.277	1.000	0.089	0.911

Head relative to low weir (m)	Total flow (cumecs)	Low weir flow (cumecs)	High weir flow (cumecs)	Fishpass flow (cumecs)	Drowned flow reduction DFRF	Weir to Total flows	Fishpass to Total flows
0.090	0.330	0.037		0.293	1.000	0.112	0.888
0.100	0.358	0.048		0.310	1.000	0.134	0.866
0.110	0.387	0.061		0.326	1.000	0.158	0.842
0.120	0.420	0.076		0.344	1.000	0.181	0.819
0.130	0.454	0.093		0.361	1.000	0.205	0.795
0.140	0.490	0.111		0.379	1.000	0.227	0.773
0.150	0.530	0.133		0.397	1.000	0.251	0.749
0.160	0.571	0.156		0.415	1.000	0.273	0.727
0.170	0.615	0.182		0.433	1.000	0.296	0.704
0.180	0.662	0.210		0.452	1.000	0.317	0.683
0.190	0.711	0.240		0.471	1.000	0.338	0.662
0.200	0.764	0.274		0.490	1.000	0.359	0.641
0.210	0.819	0.309		0.510	1.000	0.377	0.623
0.220	0.878	0.348		0.530	1.000	0.396	0.604
0.230	0.941	0.389		0.552	1.000	0.413	0.587
0.240	1.005	0.433		0.572	1.000	0.431	0.569
0.250	1.073	0.480		0.593	1.000	0.447	0.553
0.260	1.143	0.530		0.613	1.000	0.464	0.536
0.270	1.217	0.583		0.634	1.000	0.479	0.521
0.280	1.295	0.639		0.656	1.000	0.493	0.507
0.290	1.375	0.698		0.677	1.000	0.508	0.492
0.300	1.460	0.761		0.699	1.000	0.521	0.479
0.310	1.548	0.827		0.721	1.000	0.534	0.466
0.320	1.644	0.899		0.745	1.000	0.547	0.453
0.330	1.740	0.972		0.768	1.000	0.559	0.441
0.340	1.839	1.049		0.790	1.000	0.570	0.430
0.350	1.942	1.129		0.813	1.000	0.581	0.419
0.360	2.052	1.213		0.839	1.000	0.591	0.409
0.370	2.162	1.300		0.862	1.000	0.601	0.399
0.380	2.277	1.392		0.885	1.000	0.611	0.389
0.390	2.396	1.487		0.909	1.000	0.621	0.379
0.400	2.521	1.586		0.935	1.000	0.629	0.371
0.410	2.650	1.690		0.960	1.000	0.638	0.362
0.420	2.781	1.797		0.984	1.000	0.646	0.354
0.430	2.920	1.909		1.011	1.000	0.654	0.346
0.440	3.050	2.025		1.025	0.989	0.664	0.336
0.450	3.191	2.146		1.045	0.985	0.673	0.327
0.460	3.325	2.256		1.069	0.982	0.678	0.322
0.470	3.457	2.368		1.089	0.978	0.685	0.315
0.480	3.592	2.481		1.111	0.973	0.691	0.309
0.490	3.724	2.600		1.124	0.969	0.698	0.302
0.500	3.875	2.738		1.137	0.962	0.707	0.293
0.510	4.006	2.856		1.150	0.957	0.713	0.287
0.520	4.137	2.974		1.163	0.950	0.719	0.281
0.530	4.265	3.095		1.170	0.944	0.726	0.274

0.540	4.387	3.210		1.177	0.937	0.732	0.268
0.550	4.505	3.321		1.184	0.931	0.737	0.263
0.560	4.626	3.435		1.191	0.925	0.743	0.257
0.570	4.734	3.536		1.198	0.917	0.747	0.253
0.580	4.847	3.642		1.205	0.910	0.751	0.249
0.590	4.962	3.750		1.212	0.904	0.756	0.244
0.600	5.074	3.855		1.219	0.896	0.760	0.240
0.610	5.184	3.958		1.226	0.890	0.764	0.236
0.620	5.292	4.058		1.234	0.880	0.767	0.233
0.630	5.419	4.178		1.241	0.872	0.771	0.229
Head relative to low weir (m)	Total flow (cumecs)	Low weir flow (cumecs)	High weir flow (cumecs)	Fishpass flow (cumecs)	Drowned flow reduction DFRF	Weir to Total flows	Fishpass to Total flows
0.640	5.523	4.275		1.248	0.849	0.774	0.226
0.650	5.675	4.420		1.255	0.832	0.779	0.221
0.660	5.801	4.539		1.262	0.806	0.782	0.218
0.670	5.930	4.661		1.269	0.789	0.786	0.214
0.680	6.056	4.781		1.275	0.764	0.789	0.211
0.690	6.188	4.907		1.281	0.749	0.793	0.207
0.700	6.340	5.053		1.287	0.725	0.797	0.203
0.710	6.479	5.194		1.285	0.710	0.802	0.198
<b>Case 4A</b>							
0.010	0.014	0.004	0.000	0.010	1.000	0.286	0.714
0.020	0.041	0.011	0.000	0.030	1.000	0.268	0.732
0.030	0.074	0.020	0.000	0.054	1.000	0.270	0.730
0.040	0.115	0.031	0.000	0.084	1.000	0.270	0.730
0.050	0.161	0.044	0.000	0.117	1.000	0.273	0.727
0.060	0.212	0.058	0.000	0.154	1.000	0.274	0.726
0.070	0.267	0.073	0.000	0.194	1.000	0.273	0.727
0.080	0.326	0.089	0.000	0.237	1.000	0.273	0.727
0.090	0.390	0.107	0.000	0.283	1.000	0.274	0.726
0.100	0.456	0.125	0.000	0.331	1.000	0.274	0.726
0.110	0.526	0.144	0.000	0.382	1.000	0.274	0.726
0.120	0.599	0.164	0.000	0.435	1.000	0.274	0.726
0.130	0.676	0.185	0.000	0.491	1.000	0.274	0.726
0.140	0.755	0.207	0.000	0.548	1.000	0.274	0.726
0.150	0.838	0.230	0.000	0.608	1.000	0.274	0.726
0.160	0.923	0.253	0.000	0.670	1.000	0.274	0.726
0.170	1.011	0.277	0.000	0.734	1.000	0.274	0.726
0.180	1.101	0.302	0.000	0.799	1.000	0.274	0.726
0.190	1.195	0.328	0.000	0.867	1.000	0.274	0.726
0.200	1.290	0.354	0.000	0.936	1.000	0.274	0.726
0.210	1.388	0.381	0.000	1.007	1.000	0.274	0.726
0.220	1.488	0.408	0.000	1.080	1.000	0.274	0.726
0.230	1.592	0.437	0.000	1.155	1.000	0.274	0.726
0.240	1.696	0.465	0.000	1.231	1.000	0.274	0.726
0.250	1.803	0.495	0.000	1.308	1.000	0.275	0.725

0.260	1.913	0.525	0.000	1.388	1.000	0.274	0.726
0.270	2.024	0.555	0.000	1.469	1.000	0.274	0.726
0.280	2.138	0.587	0.000	1.551	1.000	0.275	0.725
0.290	2.253	0.618	0.000	1.635	1.000	0.274	0.726
0.300	2.371	0.651	0.000	1.720	1.000	0.275	0.725
0.310	2.527	0.684	0.036	1.807	1.000	0.285	0.715
0.320	2.713	0.717	0.101	1.895	1.000	0.302	0.698
0.330	2.920	0.751	0.185	1.984	1.000	0.321	0.679
0.340	3.145	0.785	0.285	2.075	1.000	0.340	0.660
0.350	3.387	0.820	0.399	2.168	1.000	0.360	0.640
0.360	3.641	0.856	0.524	2.261	1.000	0.379	0.621
0.370	3.909	0.892	0.661	2.356	1.000	0.397	0.603
0.380	4.187	0.928	0.807	2.452	1.000	0.414	0.586
0.390	4.479	0.965	0.964	2.550	1.000	0.431	0.569
0.400	4.778	1.002	1.128	2.648	1.000	0.446	0.554
0.410	5.090	1.040	1.302	2.748	1.000	0.460	0.540
0.420	5.410	1.078	1.483	2.849	1.000	0.473	0.527
0.430	5.742	1.117	1.673	2.952	1.000	0.486	0.514
0.440	6.080	1.156	1.869	3.055	1.000	0.498	0.502
0.450	6.429	1.196	2.073	3.160	1.000	0.508	0.492
Head relative to low weir (m)	Total flow (cumecs)	Low weir flow (cumecs)	High weir flow (cumecs)	Fishpass flow (cumecs)	Drowned flow reduction DFRF	Weir to Total flows	Fishpass to Total flows
0.460	6.786	1.236	2.284	3.266	1.000	0.519	0.481
0.470	7.151	1.277	2.501	3.373	1.000	0.528	0.472
0.480	7.524	1.318	2.725	3.481	1.000	0.537	0.463
0.490	7.905	1.359	2.955	3.591	1.000	0.546	0.454
0.500	8.294	1.401	3.192	3.701	1.000	0.554	0.446
0.510	8.690	1.443	3.434	3.813	1.000	0.561	0.439
0.520	9.093	1.486	3.682	3.925	1.000	0.568	0.432
0.530	9.504	1.529	3.936	4.039	1.000	0.575	0.425
0.540	9.923	1.573	4.196	4.154	1.000	0.581	0.419
0.550	10.348	1.617	4.461	4.270	1.000	0.587	0.413
0.560	10.779	1.661	4.731	4.387	1.000	0.593	0.407
0.570	11.218	1.706	5.007	4.505	1.000	0.598	0.402
0.580	11.662	1.751	5.287	4.624	1.000	0.603	0.397
0.590	12.113	1.796	5.573	4.744	1.000	0.608	0.392
0.600	12.571	1.842	5.864	4.865	1.000	0.613	0.387
0.610	13.035	1.889	6.159	4.987	1.000	0.617	0.383
0.620	13.505	1.935	6.460	5.110	1.000	0.622	0.378
0.630	13.981	1.982	6.765	5.234	1.000	0.626	0.374
0.640	14.465	2.030	7.075	5.360	1.000	0.629	0.371
0.650	14.953	2.078	7.389	5.486	1.000	0.633	0.367
0.660	15.447	2.126	7.708	5.613	1.000	0.637	0.363
0.670	15.947	2.174	8.032	5.741	1.000	0.640	0.360
0.680	16.452	2.223	8.359	5.870	1.000	0.643	0.357
0.690	16.964	2.272	8.692	6.000	1.000	0.646	0.354
0.700	17.481	2.322	9.028	6.131	1.000	0.649	0.351

0.710	18.003	2.372	9.369	6.262	1.000	0.652	0.348
0.720	18.530	2.422	9.713	6.395	1.000	0.655	0.345
0.730	19.065	2.473	10.063	6.529	1.000	0.658	0.342
0.740	19.603	2.524	10.415	6.664	1.000	0.660	0.340
0.750	20.147	2.575	10.773	6.799	1.000	0.663	0.337
0.760	20.697	2.627	11.134	6.936	1.000	0.665	0.335
0.770	21.251	2.679	11.499	7.073	1.000	0.667	0.333
0.780	21.811	2.732	11.868	7.211	1.000	0.669	0.331
0.790	22.374	2.784	12.240	7.350	1.000	0.671	0.329
0.800	22.944	2.837	12.617	7.490	1.000	0.674	0.326
0.810	23.409	2.861	12.997	7.551	0.990	0.677	0.323
0.820	23.929	2.885	13.382	7.662	0.986	0.680	0.320
0.830	24.440	2.909	13.769	7.762	0.981	0.682	0.318
0.840	24.952	2.933	14.161	7.858	0.975	0.685	0.315
0.850	25.461	2.958	14.556	7.947	0.969	0.688	0.312
0.860	25.808	2.982	14.795	8.031	0.962	0.689	0.311
0.870	26.292	3.004	15.147	8.141	0.958	0.690	0.310
0.880	26.723	3.029	15.467	8.227	0.952	0.692	0.308
0.890	27.150	3.053	15.785	8.312	0.946	0.694	0.306
0.900	27.557	3.077	16.092	8.388	0.939	0.696	0.304
0.910	27.927	3.101	16.398	8.428	0.931	0.698	0.302
0.920	28.297	3.125	16.704	8.468	0.924	0.701	0.299
0.930	28.655	3.149	16.998	8.508	0.916	0.703	0.297
0.940	28.998	3.173	17.277	8.548	0.907	0.705	0.295
0.950	29.363	3.197	17.578	8.588	0.899	0.708	0.292
0.960	29.693	3.221	17.844	8.628	0.889	0.709	0.291
0.970	30.031	3.246	18.117	8.668	0.879	0.711	0.289
0.980	30.380	3.270	18.402	8.708	0.867	0.713	0.287
0.990	30.788	3.296	18.744	8.748	0.852	0.716	0.284
1.000	31.195	3.324	19.083	8.788	0.838	0.718	0.282
Head relative to low weir (m)	Total flow (cumecs)	Low weir flow (cumecs)	High weir flow (cumecs)	Fishpass flow (cumecs)	Drowned flow reduction DFRF	Weir to Total flows	Fishpass to Total flows
1.010	31.522	3.324	19.380	8.818	0.816	0.720	0.280
1.020	31.873	3.324	19.711	8.838	0.803	0.723	0.277
1.030	32.210	3.324	20.038	8.848	0.789	0.725	0.275
1.040	32.533	3.324	20.361	8.848	0.776	0.728	0.272
1.050	32.850	3.324	20.678	8.848	0.764	0.731	0.269
1.060	33.161	3.324	20.989	8.848	0.751	0.733	0.267
1.070	33.464	3.324	21.292	8.848	0.739	0.736	0.264
1.080	33.759	3.324	21.587	8.848	0.727	0.738	0.262
1.090	34.043	3.324	21.871	8.848	0.715	0.740	0.260
1.100	34.150	3.324	21.978	8.848	0.703	0.741	0.259
1.110	34.378	3.324	22.206	8.848	0.700	0.743	0.257
<b>Case 4B</b>							
-0.170	0.010	0.000	0.000	0.010	1.000	0.000	1.000
-0.160	0.030	0.000	0.000	0.030	1.000	0.000	1.000

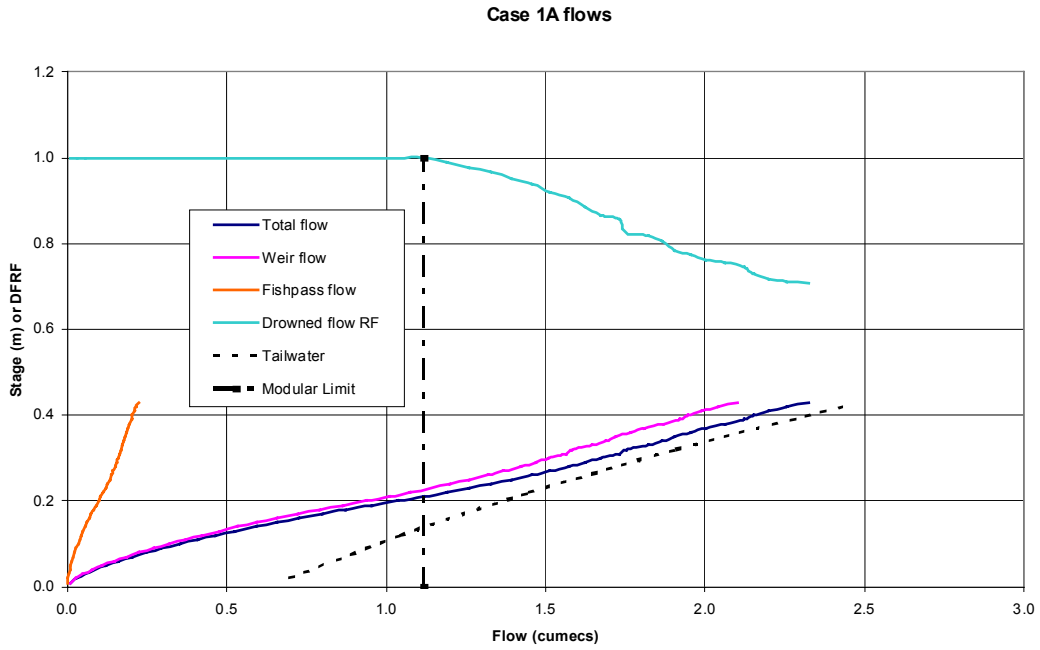
-0.150	0.054	0.000	0.000	0.054	1.000	0.000	1.000
-0.140	0.084	0.000	0.000	0.084	1.000	0.000	1.000
-0.130	0.117	0.000	0.000	0.117	1.000	0.000	1.000
-0.120	0.154	0.000	0.000	0.154	1.000	0.000	1.000
-0.110	0.194	0.000	0.000	0.194	1.000	0.000	1.000
-0.100	0.237	0.000	0.000	0.237	1.000	0.000	1.000
-0.090	0.283	0.000	0.000	0.283	1.000	0.000	1.000
-0.080	0.331	0.000	0.000	0.331	1.000	0.000	1.000
-0.070	0.382	0.000	0.000	0.382	1.000	0.000	1.000
-0.060	0.435	0.000	0.000	0.435	1.000	0.000	1.000
-0.050	0.491	0.000	0.000	0.491	1.000	0.000	1.000
-0.040	0.548	0.000	0.000	0.548	1.000	0.000	1.000
-0.030	0.608	0.000	0.000	0.608	1.000	0.000	1.000
-0.020	0.670	0.000	0.000	0.670	1.000	0.000	1.000
-0.010	0.734	0.000	0.000	0.734	1.000	0.000	1.000
0.000	0.799	0.000	0.000	0.799	1.000	0.000	1.000
0.010	0.871	0.004	0.000	0.867	1.000	0.005	0.995
0.020	0.947	0.011	0.000	0.936	1.000	0.012	0.988
0.030	1.027	0.020	0.000	1.007	1.000	0.019	0.981
0.040	1.111	0.031	0.000	1.080	1.000	0.028	0.972
0.050	1.199	0.044	0.000	1.155	1.000	0.037	0.963
0.060	1.289	0.058	0.000	1.231	1.000	0.045	0.955
0.070	1.381	0.073	0.000	1.308	1.000	0.053	0.947
0.080	1.477	0.089	0.000	1.388	1.000	0.060	0.940
0.090	1.576	0.107	0.000	1.469	1.000	0.068	0.932
0.100	1.676	0.125	0.000	1.551	1.000	0.075	0.925
0.110	1.779	0.144	0.000	1.635	1.000	0.081	0.919
0.120	1.884	0.164	0.000	1.720	1.000	0.087	0.913
0.130	1.992	0.185	0.000	1.807	1.000	0.093	0.907
0.140	2.102	0.207	0.000	1.895	1.000	0.098	0.902
0.150	2.214	0.230	0.000	1.984	1.000	0.104	0.896
0.160	2.328	0.253	0.000	2.075	1.000	0.109	0.891
0.170	2.445	0.277	0.000	2.168	1.000	0.113	0.887
0.180	2.563	0.302	0.000	2.261	1.000	0.118	0.882
0.190	2.684	0.328	0.000	2.356	1.000	0.122	0.878
0.200	2.806	0.354	0.000	2.452	1.000	0.126	0.874
0.210	2.931	0.381	0.000	2.550	1.000	0.130	0.870
0.220	3.056	0.408	0.000	2.648	1.000	0.134	0.866
0.230	3.185	0.437	0.000	2.748	1.000	0.137	0.863
0.240	3.314	0.465	0.000	2.849	1.000	0.140	0.860
Head relative to low weir (m)	Total flow (cumecs)	Low weir flow (cumecs)	High weir flow (cumecs)	Fishpass flow (cumecs)	Drowned flow reduction DFRF	Weir to Total flows	Fishpass to Total flows
0.250	3.447	0.495	0.000	2.952	1.000	0.144	0.856
0.260	3.580	0.525	0.000	3.055	1.000	0.147	0.853
0.270	3.715	0.555	0.000	3.160	1.000	0.149	0.851
0.280	3.853	0.587	0.000	3.266	1.000	0.152	0.848
0.290	3.991	0.618	0.000	3.373	1.000	0.155	0.845

0.300	4.132	0.651	0.000	3.481	1.000	0.158	0.842
0.310	4.311	0.684	0.036	3.591	1.000	0.167	0.833
0.320	4.519	0.717	0.101	3.701	1.000	0.181	0.819
0.330	4.749	0.751	0.185	3.813	1.000	0.197	0.803
0.340	4.995	0.785	0.285	3.925	1.000	0.214	0.786
0.350	5.258	0.820	0.399	4.039	1.000	0.232	0.768
0.360	5.534	0.856	0.524	4.154	1.000	0.249	0.751
0.370	5.823	0.892	0.661	4.270	1.000	0.267	0.733
0.380	6.122	0.928	0.807	4.387	1.000	0.283	0.717
0.390	6.434	0.965	0.964	4.505	1.000	0.300	0.700
0.400	6.754	1.002	1.128	4.624	1.000	0.315	0.685
0.410	7.086	1.040	1.302	4.744	1.000	0.331	0.669
0.420	7.426	1.078	1.483	4.865	1.000	0.345	0.655
0.430	7.777	1.117	1.673	4.987	1.000	0.359	0.641
0.440	8.135	1.156	1.869	5.110	1.000	0.372	0.628
0.450	8.503	1.196	2.073	5.234	1.000	0.384	0.616
0.460	8.880	1.236	2.284	5.360	1.000	0.396	0.604
0.470	9.264	1.277	2.501	5.486	1.000	0.408	0.592
0.480	9.656	1.318	2.725	5.613	1.000	0.419	0.581
0.490	10.055	1.359	2.955	5.741	1.000	0.429	0.571
0.500	10.463	1.401	3.192	5.870	1.000	0.439	0.561
0.510	10.877	1.443	3.434	6.000	1.000	0.448	0.552
0.520	11.299	1.486	3.682	6.131	1.000	0.457	0.543
0.530	11.727	1.529	3.936	6.262	1.000	0.466	0.534
0.540	12.164	1.573	4.196	6.395	1.000	0.474	0.526
0.550	12.607	1.617	4.461	6.529	1.000	0.482	0.518
0.560	13.056	1.661	4.731	6.664	1.000	0.490	0.510
0.570	13.512	1.706	5.007	6.799	1.000	0.497	0.503
0.580	13.974	1.751	5.287	6.936	1.000	0.504	0.496
0.590	14.442	1.796	5.573	7.073	1.000	0.510	0.490
0.600	14.917	1.842	5.864	7.211	1.000	0.517	0.483
0.610	15.398	1.889	6.159	7.350	1.000	0.523	0.477
0.620	15.885	1.935	6.460	7.490	1.000	0.528	0.472
0.630	16.378	1.982	6.765	7.631	1.000	0.534	0.466
0.640	16.878	2.030	7.075	7.773	1.000	0.539	0.461
0.650	17.382	2.078	7.389	7.915	1.000	0.545	0.455
0.660	17.893	2.126	7.708	8.059	1.000	0.550	0.450
0.670	18.409	2.174	8.032	8.203	1.000	0.554	0.446
0.680	18.930	2.223	8.359	8.348	1.000	0.559	0.441
0.690	19.459	2.272	8.692	8.495	1.000	0.563	0.437
0.700	19.991	2.322	9.028	8.641	1.000	0.568	0.432
0.710	20.530	2.372	9.369	8.789	1.000	0.572	0.428
0.720	20.978	2.422	9.713	8.843	0.989	0.578	0.422
0.730	21.496	2.473	10.063	8.960	0.986	0.583	0.417
0.740	22.005	2.524	10.415	9.066	0.981	0.588	0.412
0.750	22.493	2.548	10.773	9.172	0.977	0.592	0.408
0.760	22.989	2.587	11.134	9.268	0.972	0.597	0.403
0.770	23.481	2.624	11.499	9.358	0.965	0.601	0.399
0.780	23.969	2.659	11.868	9.442	0.959	0.606	0.394
0.790	24.457	2.694	12.240	9.523	0.952	0.611	0.389

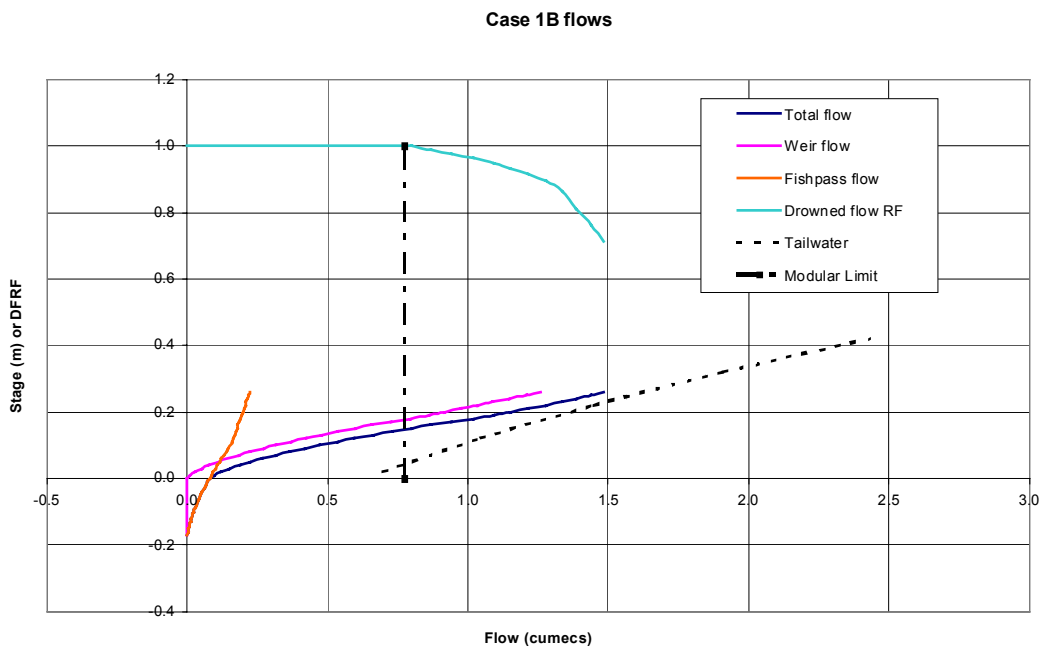
Head relative to low weir (m)	Total flow (cumecs)	Low weir flow (cumecs)	High weir flow (cumecs)	Fishpass flow (cumecs)	Drowned flow reduction DFRF	Weir to Total flows	Fishpass to Total flows
0.800	24.935	2.726	12.617	9.592	0.944	0.615	0.385
0.810	25.276	2.764	12.826	9.686	0.939	0.617	0.383
0.820	25.689	2.796	13.137	9.756	0.932	0.620	0.380
0.830	26.100	2.828	13.447	9.825	0.925	0.624	0.376
0.840	26.488	2.858	13.749	9.881	0.916	0.627	0.373
0.850	26.873	2.887	14.051	9.935	0.908	0.630	0.370
0.860	27.228	2.912	14.343	9.973	0.898	0.634	0.366
0.870	27.583	2.938	14.637	10.008	0.889	0.637	0.363
0.880	27.947	2.965	14.937	10.045	0.879	0.641	0.359
0.890	28.229	2.988	15.229	10.012	0.864	0.645	0.355
0.900	28.595	3.021	15.552	10.022	0.843	0.650	0.350
0.910	28.954	3.051	15.871	10.032	0.823	0.654	0.346
0.920	29.342	3.088	16.212	10.042	0.810	0.658	0.342
0.930	29.692	3.115	16.525	10.052	0.790	0.661	0.339
0.940	30.073	3.149	16.862	10.062	0.778	0.665	0.335
0.950	30.387	3.149	17.166	10.072	0.759	0.669	0.331
0.960	30.729	3.149	17.498	10.082	0.747	0.672	0.328
0.970	31.068	3.149	17.827	10.092	0.736	0.675	0.325
0.980	31.404	3.149	18.153	10.102	0.725	0.678	0.322
0.990	31.737	3.149	18.476	10.112	0.714	0.681	0.319
1.000	32.066	3.149	18.795	10.122	0.703	0.684	0.316

**Note.** The flow data listed above is plotted on the following pages, one plot for each of the test cases. In all cases the stage plotted is the head above the lowest crest level of the gauging structure, not above the fishpass level. Fishpass levels are equal to the lowest crest level in those cases designated with an "A". Fishpass levels are 0.18m below the lowest crest level in those cases designated with an "B".

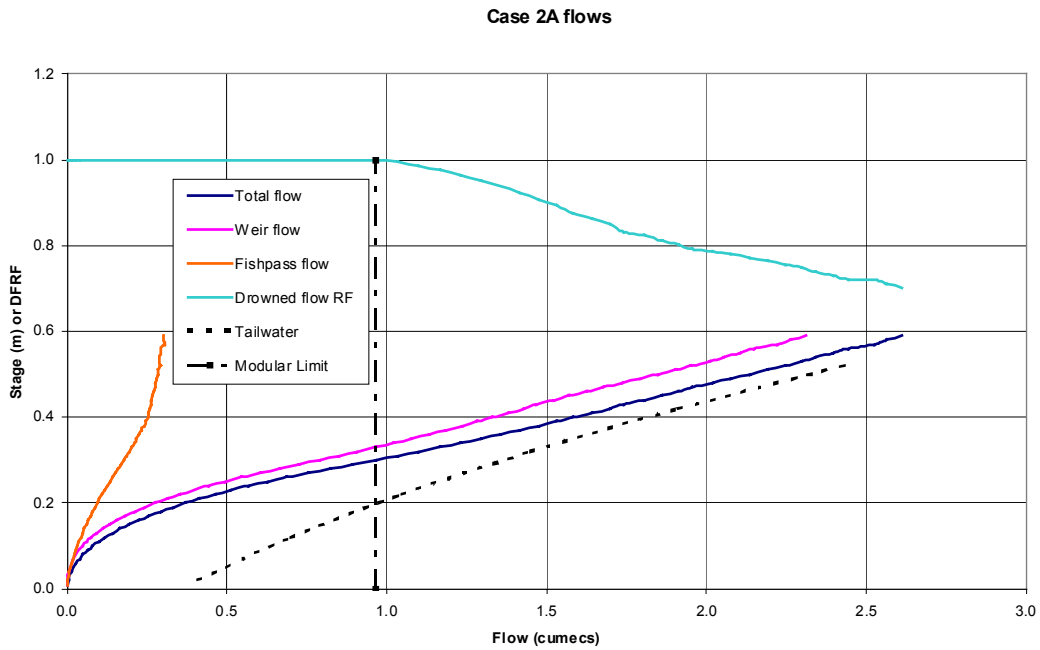




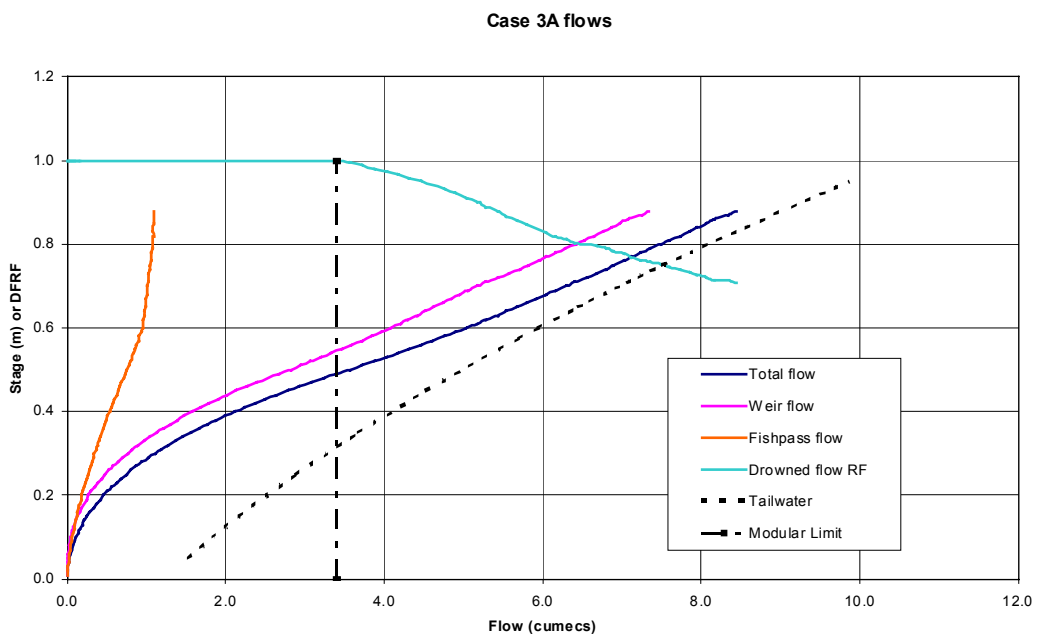
**Figure C.1 Case 1A, 5m channel, Crump weir, fishpass at weir level**



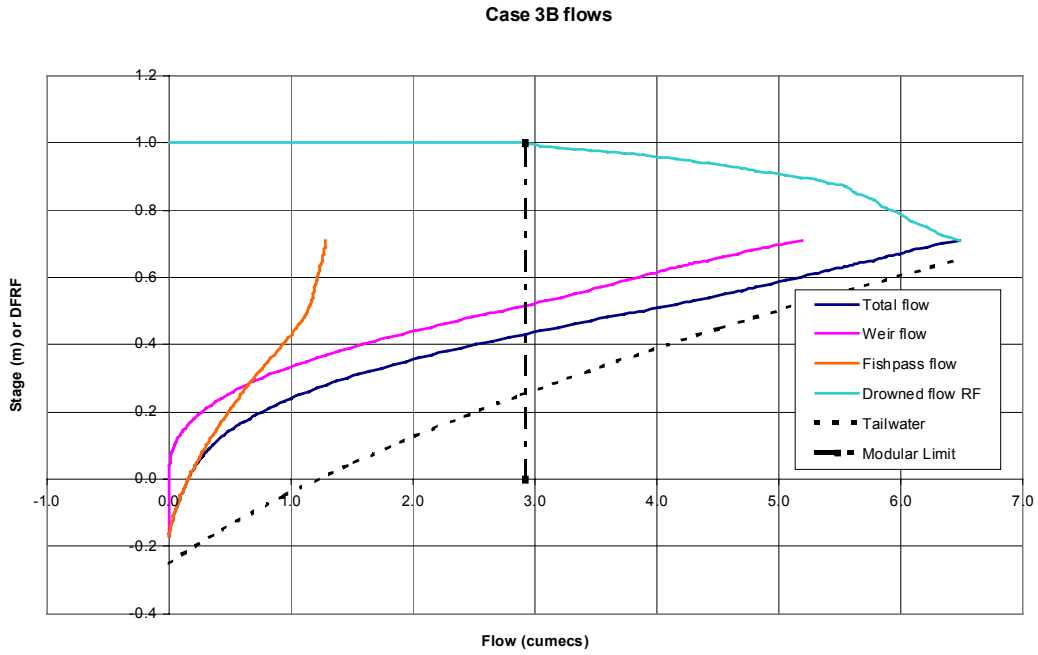
**Figure C.2 Case 1B, 5m channel, Crump weir, fishpass below weir level**



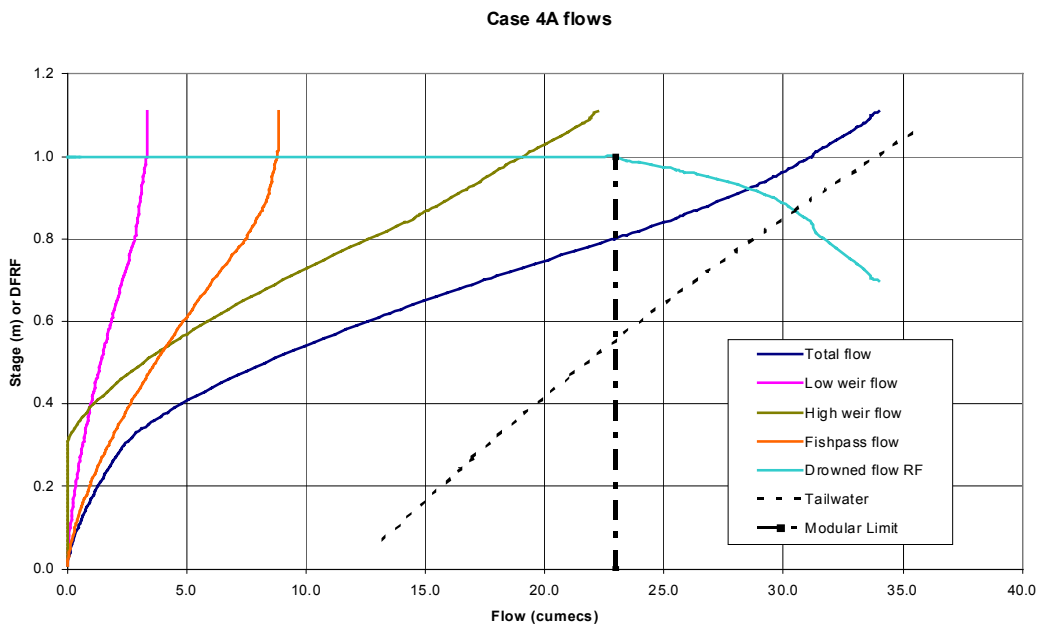
**Figure C.3 Case 2A, 5m channel, flat-V weir, fishpass at weir level**



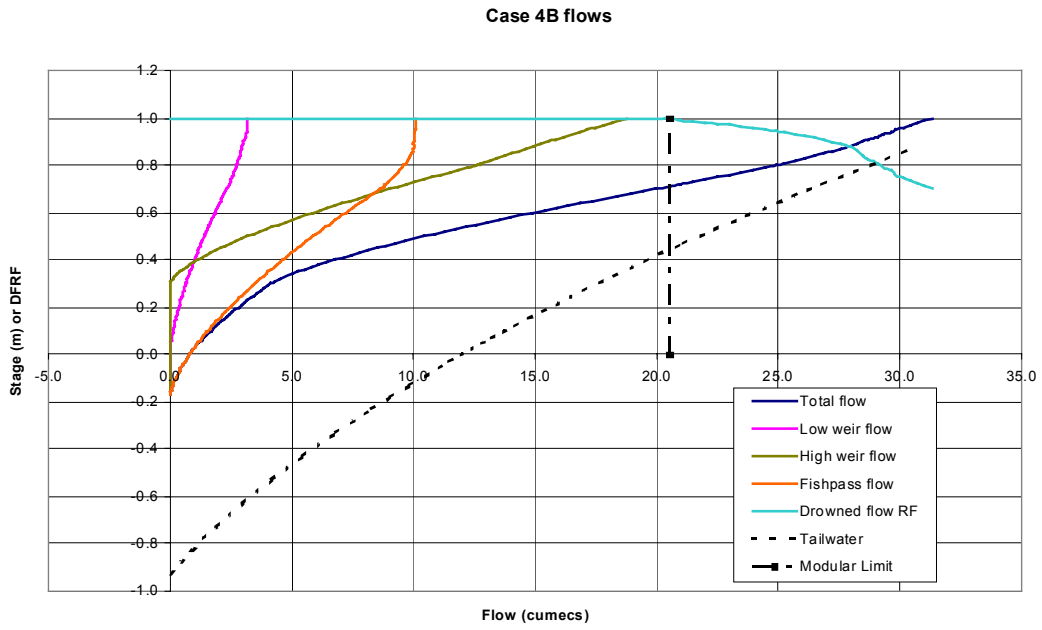
**Figure C.4 Case 3A, 10m channel, flat-V weir, fishpass at weir level**



**Figure C.5 Case 3B, 10m channel, flat-V weir, fishpass below weir level**



**Figure C.6 Case 4A, 20m channel, compound weir, fishpass at weir level**



**Figure C.7 Case 4B, 20m channel, compound weir, fishpass below weir level**

## Appendix D

Summary of combined gauging structure / fishpass uncertainties in flow

**Note.** In all cases the head plotted is the head above the lowest crest level of the gauging structure, not above the fishpass level.

### Key to Figures D1, D2 and D3.

Combination ( $X_{fp} = 2X_{weir}$ )	The assumed overall uncertainty in flow through the fishpass is two times the computed overall uncertainty for the gauging structure.
Combination ( $X_{fp} = 3X_{weir}$ )	The assumed overall uncertainty in flow through the fishpass is three times the computed overall uncertainty for the gauging structure.
Combination ( $X_{fp} = 4X_{weir}$ )	The assumed overall uncertainty in flow through the fishpass is four times the computed overall uncertainty for the gauging structure.

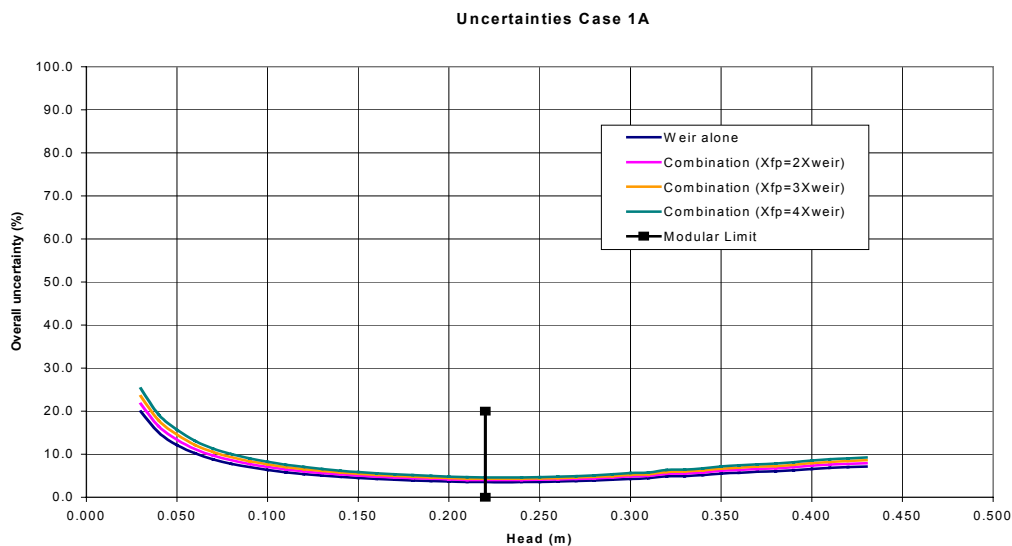
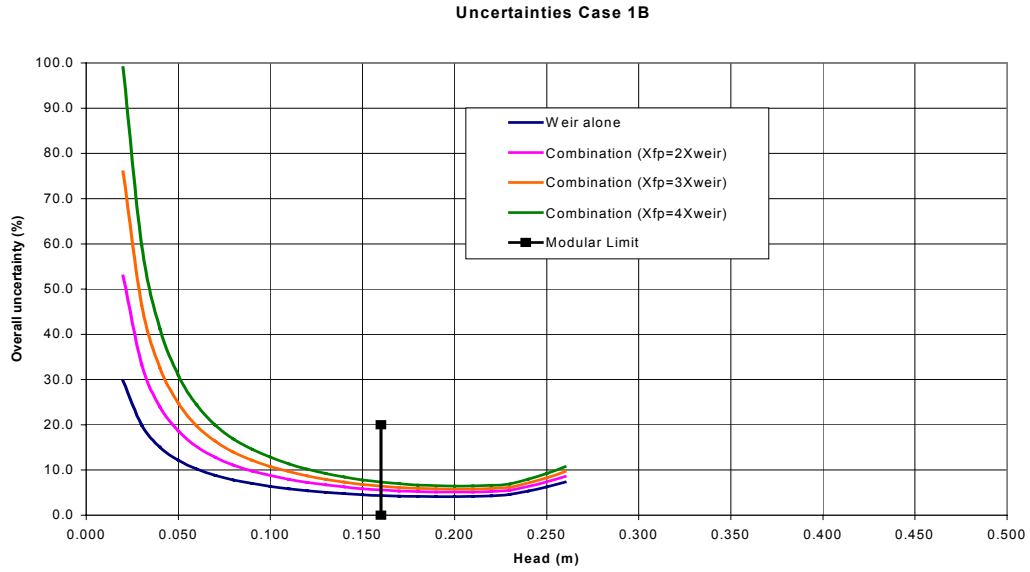
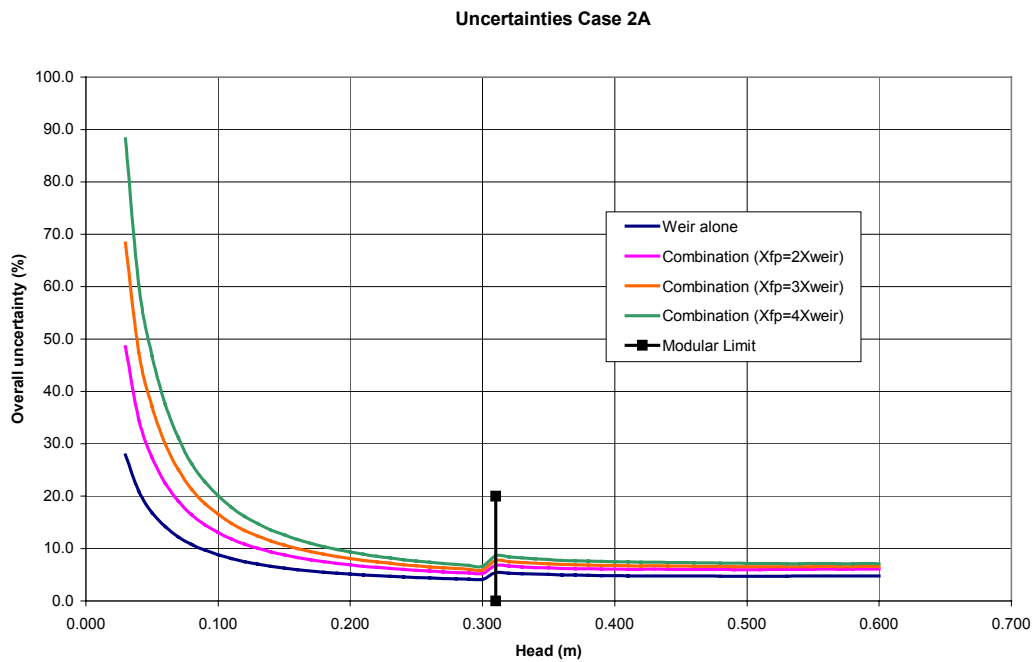


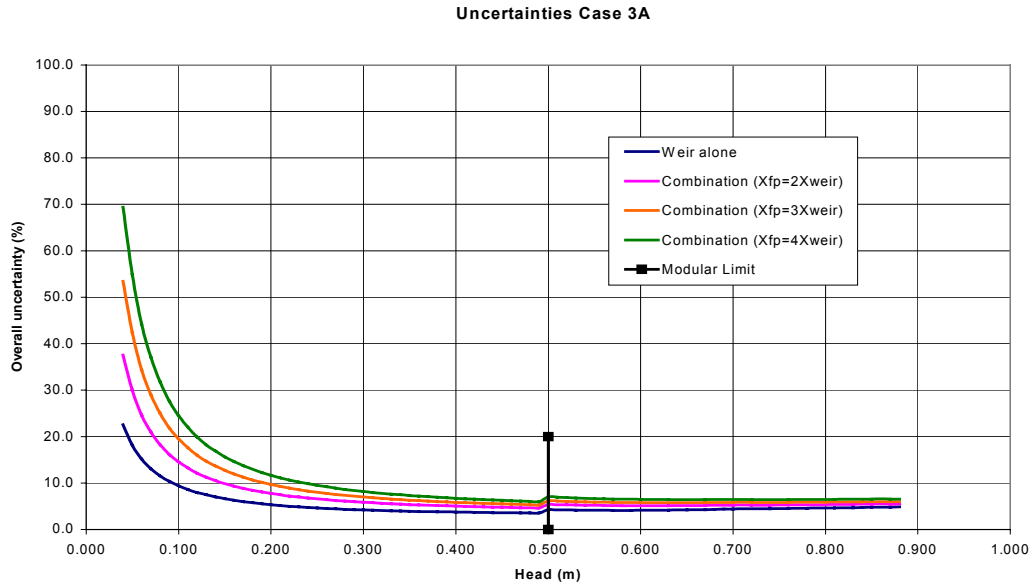
Figure D.1 Case 1A, 5m channel, Crump weir, fishpass at weir level



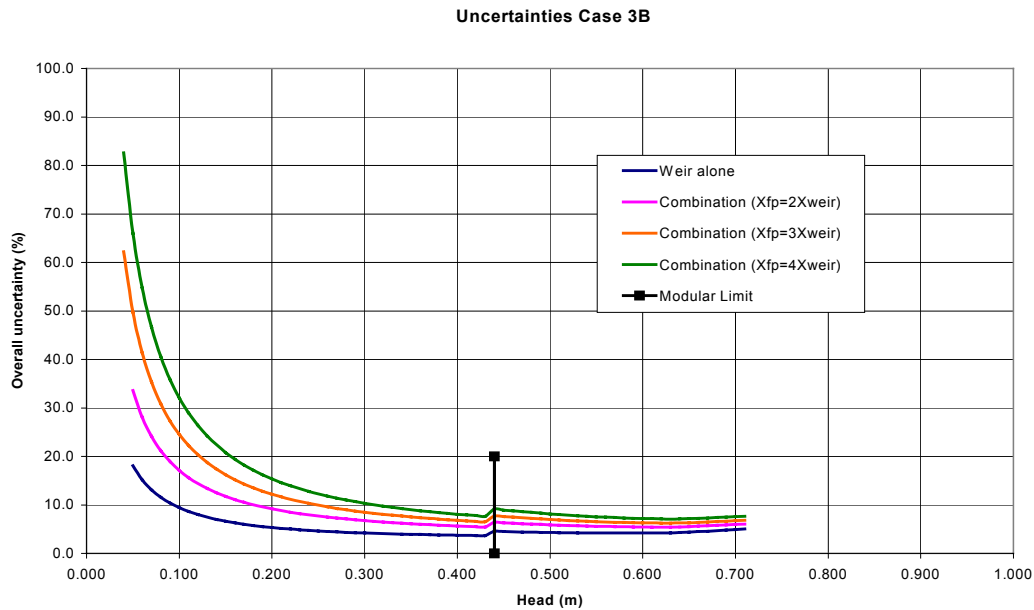
**Figure D.2 Case 1B, 5m channel, Crump weir, fishpass below weir level**



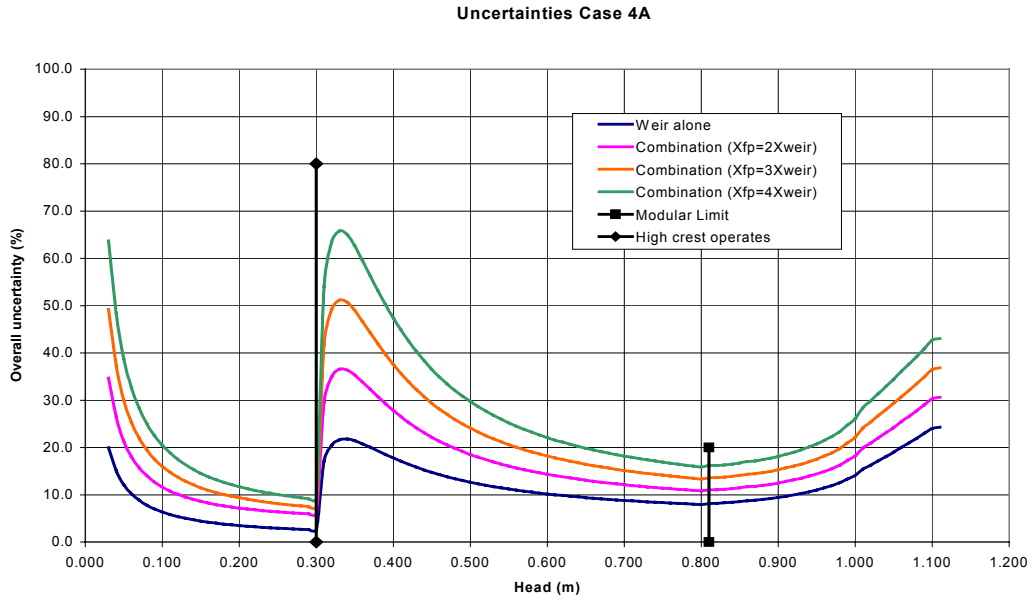
**Figure D.3 Case 2A, 5m channel, flat-V weir, fishpass at weir level**



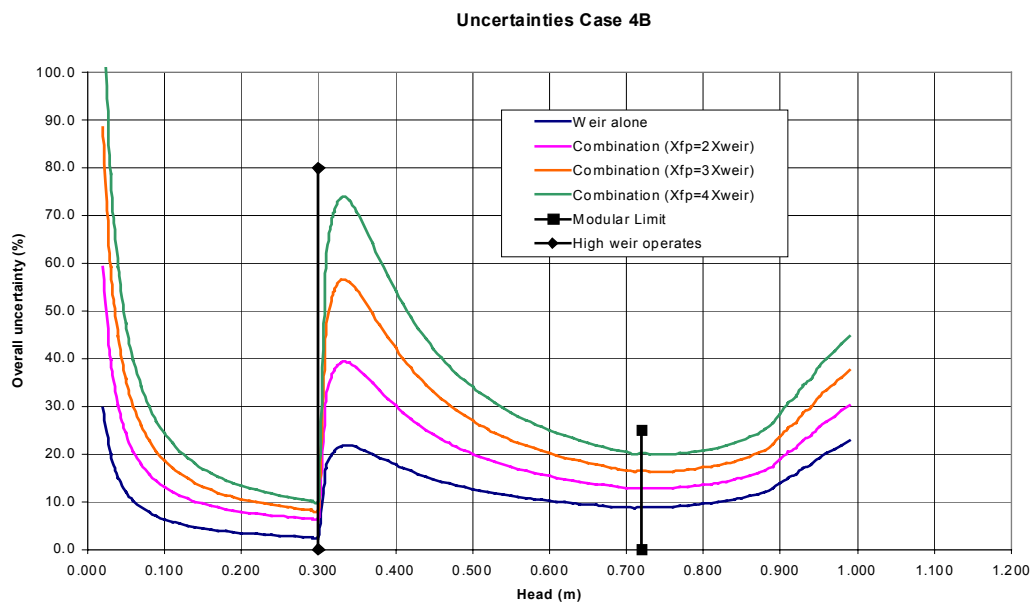
**Figure D.4 Case 3A, 10m channel, flat-V weir, fishpass at weir level**



**Figure D.5 Case 3B, 10m channel, flat-V weir, fishpass below weir level**



**Figure D.6 Case 4A, 20m channel, compound weir, fishpass at weir level**



**Figure D.7 Case 4B, 20m channel, compound weir, fishpass below weir level**



# Appendix E

Trash study - field records

See Table 3.1 for listing and details

## Appendix F

### General Purpose Flume at HR Wallingford



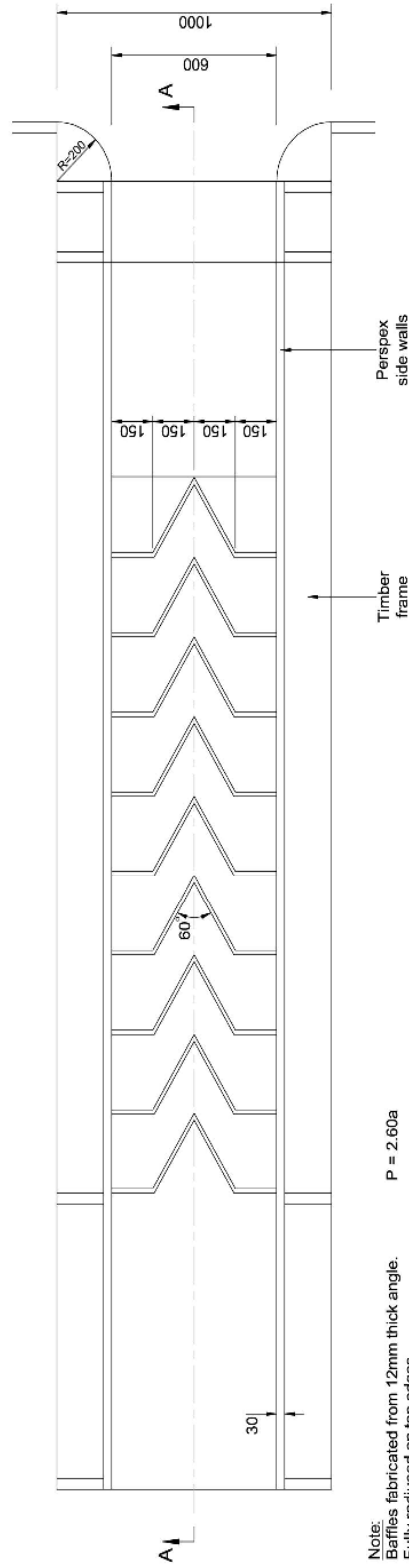
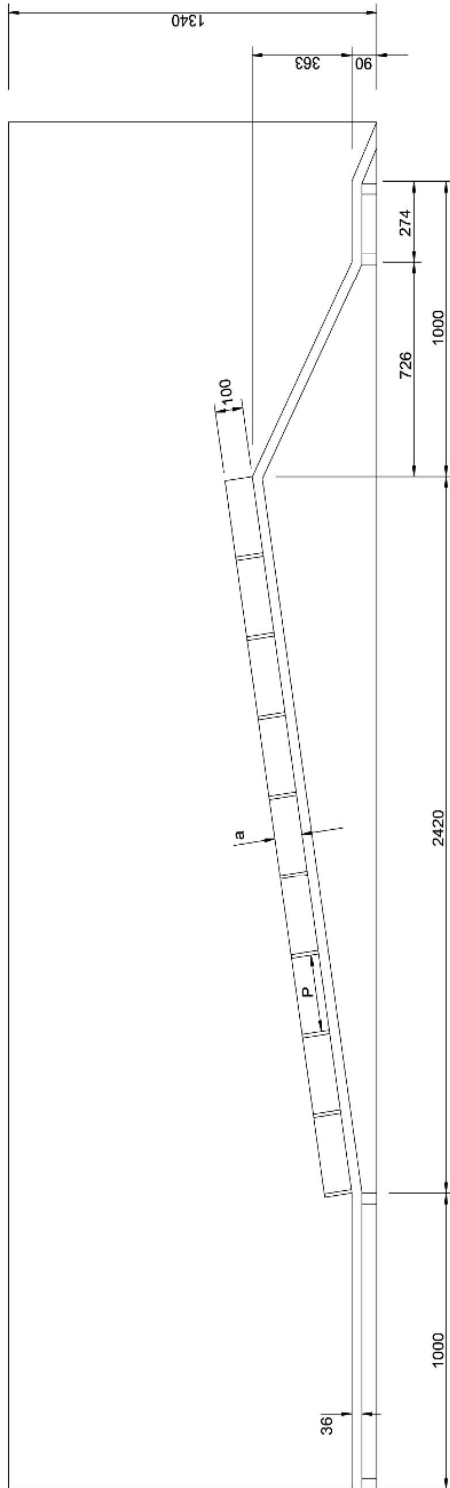
**Figure F.1** Flume arrangement looking upstream



**Figure F.2** Volumetric deflector gear

# Appendix G

## Larinier super-active fishpass with 100mm baffles



Note:  
 Baffles fabricated from 12mm thick angle.  
 Fully radiused on top edges.  
 All dimensions in mm, prototype.

P = 2,600

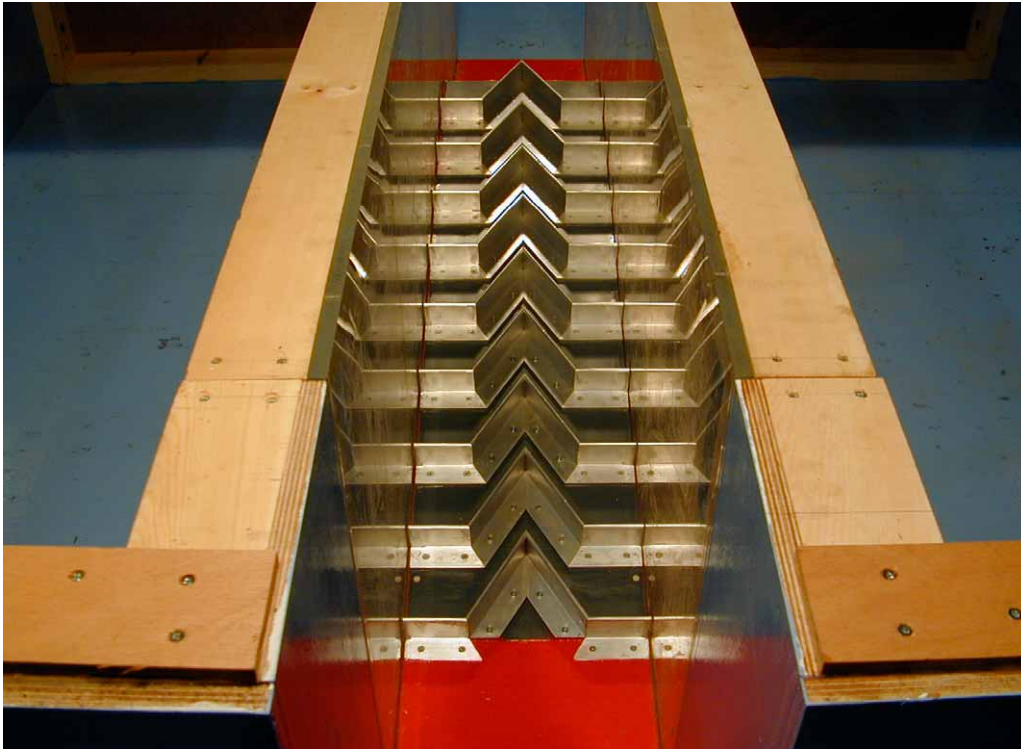
## Appendix H

### Larinier flows - numerical values

Upstream gauged head (m)	Flow per Larinier unit (cumecs)	Flow per metre Width (cumecs)
0.020	0.003	0.004
0.030	0.005	0.009
0.040	0.008	0.014
0.050	0.012	0.021
0.060	0.017	0.028
0.070	0.022	0.037
0.080	0.028	0.047
0.090	0.033	0.055
0.100	0.038	0.063
0.110	0.044	0.073
0.120	0.049	0.082
0.130	0.055	0.092
0.140	0.061	0.102
0.150	0.067	0.112
0.160	0.074	0.123
0.170	0.080	0.133
0.180	0.087	0.145
0.190	0.093	0.155
0.200	0.100	0.167
0.220	0.113	0.188
0.240	0.127	0.212
0.260	0.142	0.237
0.280	0.159	0.265
0.300	0.176	0.293
0.320	0.194	0.323
0.340	0.212	0.353
0.360	0.231	0.385
0.380	0.251	0.418
0.400	0.271	0.452
0.420	0.292	0.487
0.440	0.313	0.522
0.460	0.334	0.557
0.480	0.356	0.593
0.500	0.379	0.632
0.520	0.402	0.670
0.540	0.425	0.708
0.560	0.449	0.748
0.580	0.473	0.788
0.600	0.498	0.830
0.620	0.523	0.872
0.640	0.548	0.913
0.660	0.574	0.957
0.680	0.601	1.002
0.700	0.627	1.045

# Appendix I

## Hydrometric calibration of Larinier fishpass



**Figure I.1 Larinier fishpass looking upstream**



**Figure I.2 First three baffles of Larinier fishpass**





**Figure I.3** Flow conditions at a head of 0.1m



**Figure I.4** Flow conditions at a head of 0.2m



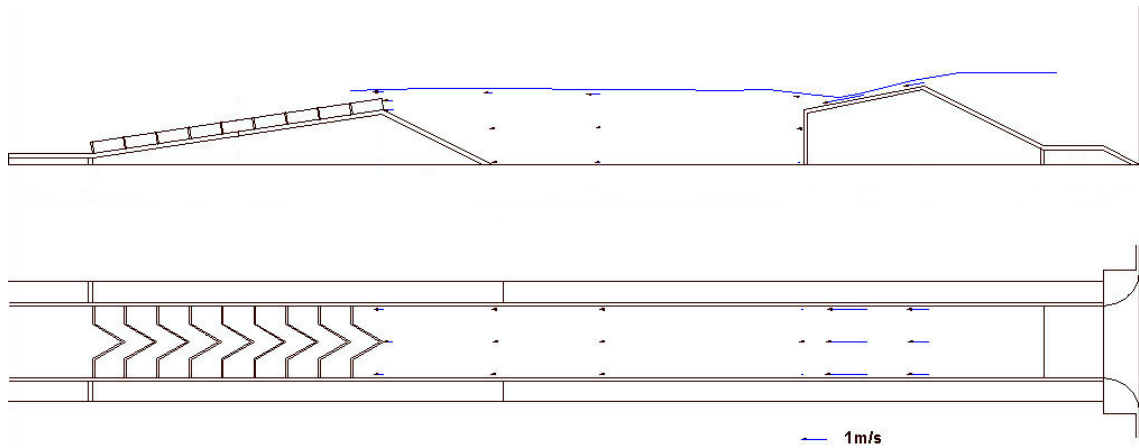
**Figure I.5** Flow conditions at a head of 0.4m



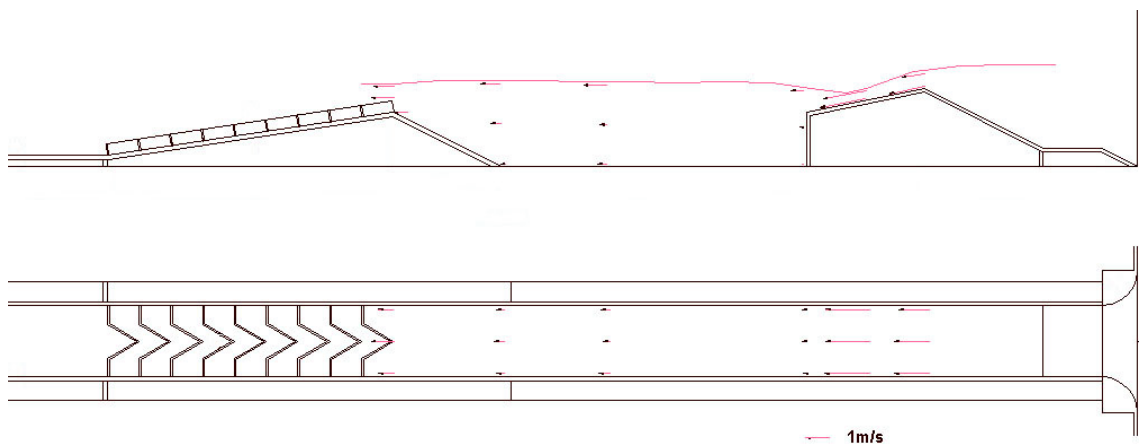
**Figure I.6** Flow conditions at a head of 0.6m

# Appendix J

## Velocities through fishpass / gauging structure arrangement

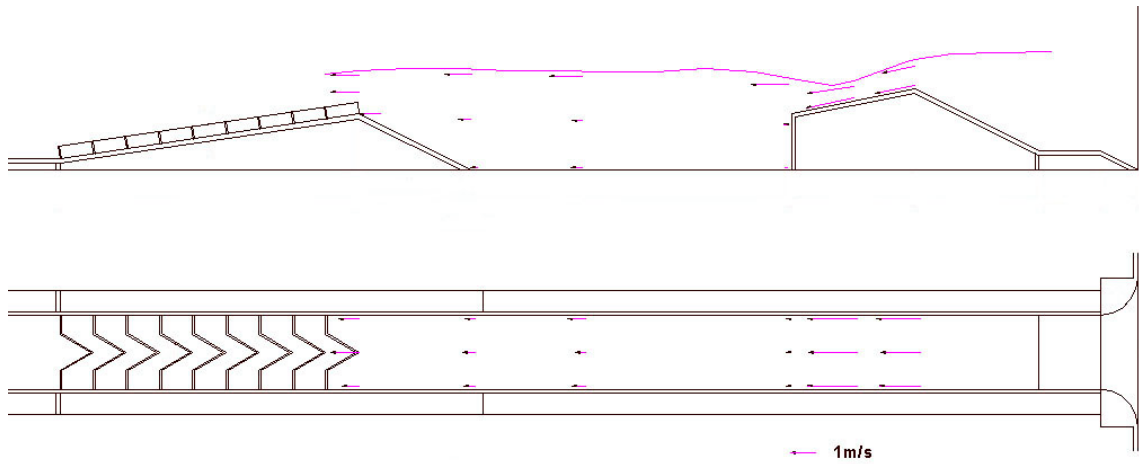


**Figure J.1 Head on the Larinier fishpass, 0.1 m**

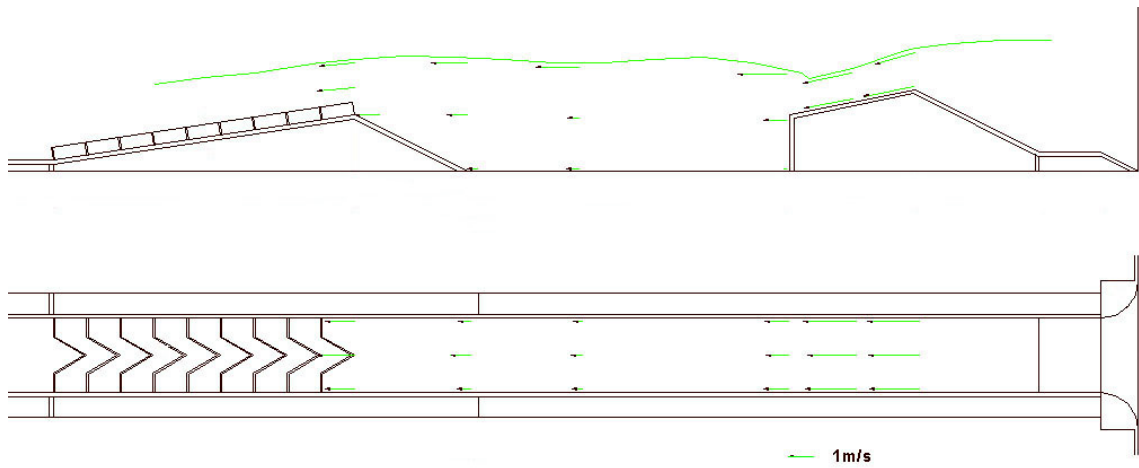


**Figure J.2 Head on the Larinier fishpass, 0.2 m**

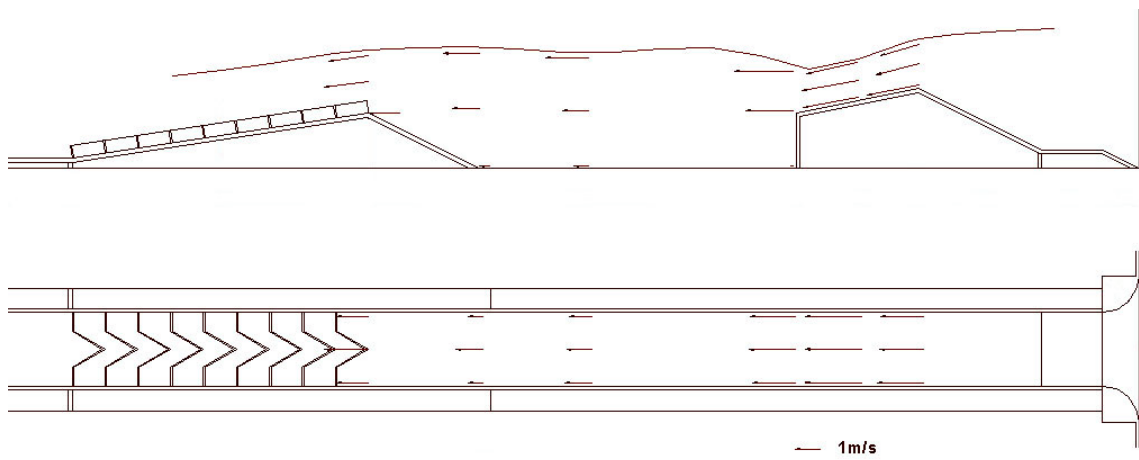




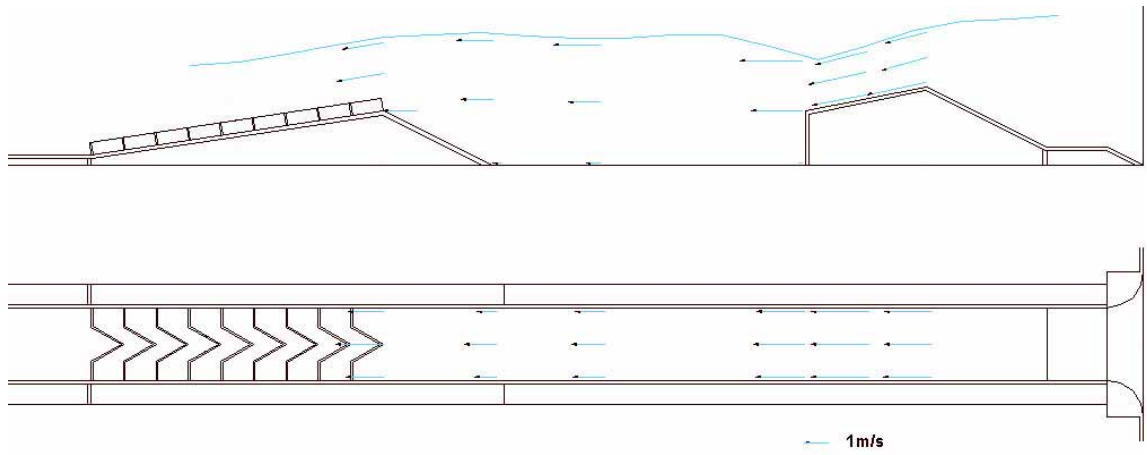
**Figure J.3 Head on the Larinier fishpass, 0.3 m**



**Figure J.4 Head on the Larinier fishpass, 0.4 m**



**Figure J.5 Head on the Larinier fishpass, 0.5 m**



**Figure J.6 Head on the Larinier fishpass, 0.6 m**

## Appendix K

Flow conditions, fishpass / gauging structure arrangement



Figure K.1 Head on Larinier fishpass, 0.1 m



Figure K.2 Head on Larinier fishpass, 0.2 m



Figure K.3 Head on Larinier fishpass, 0.3 m



**Figure K.4 Head on Larinier fishpass, 0.4 m**



**Figure K.5 Head on Larinier fishpass, 0.5 m**



**Figure K.6 Head on Larinier fishpass, 0.6 m**



# Appendix L

## Fishpass/gauging structure arrangement testing

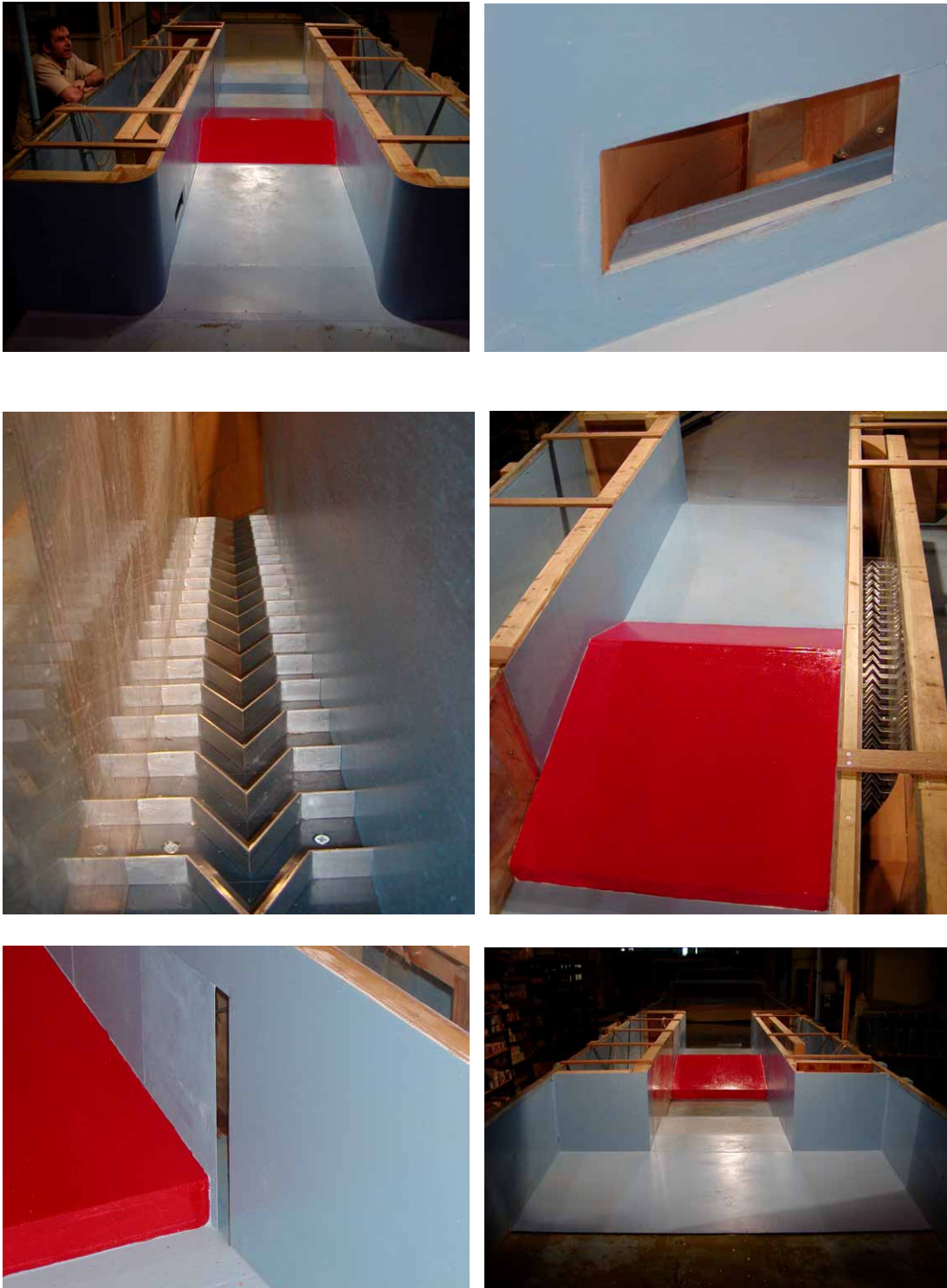


Figure L.1 General arrangement test facility - Series A



Figure L.2 Series A, Test 2



Figure L.3 Series A, Test 2



Figure L.4 Series A, Test 3



**Figure L.5 Series A, Test 4**



**Figure L.6 Modifications to the upstream entry orifice to fishpass for Series B**





**Figure L.7 Series B, Test 1**



**Figure L.8 Series B, Test 2**



**Figure L.9 Series B, Test 3**





**Figure L.10 Series B, Test 4**



**Figure L.11 Series B, Test 5**

# Appendix M

## Draft Standard - Fishpasses at flow gauging structures

### 1 Scope

**1.1** Flow gauging structures are commonly used for the measurement of open channel flows. To operate satisfactorily these structures require a head difference to be generated between the upstream and downstream water levels. At those structures which are designed to operate in the modular flow range, an upstream head measurement is used to interpret flow rates. At those structures which are designed to operate in both the modular and drowned flow ranges, the upstream head measurement is augmented by a second measurement which senses tailwater conditions. The former type tend to require higher head losses over the structure.

**1.2** In recent years greater emphasis is being placed on environmental issues, including the free migration of fish in natural watercourses. It is acknowledged that flow gauging structures, with their requirement for a head loss between upstream and downstream conditions, may inhibit the movement of fish. It has become important, therefore, to consider ways of aiding fish migration without seriously affecting flow measurement accuracy.

**1.3** This draft Standard concerns the integration of fishpasses with flow gauging structures. It identifies those fishpasses which have satisfactory hydrometric calibration data and gives methods for computing combined flows and uncertainties.

### 2 Normative references

The following referenced documents, Table M.1, are indispensable for the application of this document. For dated references, only the addition cited applies. For undated references, the latest edition of the referenced document (including any amendments) applies.

### 3 Terms and definitions

For the purpose of this document, the terms and definitions given in ISO 772 shall apply.

### 4 Principle

The discharge over a flow gauging structure is a function of the upstream head (plus a measure of the downstream head in the case of those structures designed to operate in the drowned flow range). When a fishpass is placed alongside a flow gauging structure an additional flow path is created. In certain circumstances, where the fishpass has a well defined hydrometric calibration, total flows and uncertainties may be calculated. Thus the fishpass becomes an integral part of the flow measurement system and can be regarded as a

separate section of a compound gauging structure. This document provides the necessary design and performance information for this type of arrangement.

**Table M.1 British and International Standards**

<b>International Standard</b>	<b>British Standard (BSI/CPI/113 Hydrometry)</b>	<b>Flow Measurement Structure</b>
ISO 772 ISO 1438/1:1980	BS EN ISO 772:2001 BS 3680:Part4A:1981	Vocabulary and symbols Thin plate weirs
ISO 4360:1984	BS 3680:Part4B:1986	Triangular profile weirs
ISO 4359:1983	BS 3680:Part4C:1981	Long throated flumes
ISO 14139:2000 ISO 3846:1989	BS 14139:2000 BS 3680:Part4E:1990	Compound gauging structures Rectangular broad crested weirs
ISO 4374:1989	BS 3680:Part4F:1990	Round nose horizontal crest weirs
ISO 4377:1990 ISO 8368:1999	BS 3680:Part4G:2002 BS 3680:Part4H:1999	Flat-V weirs Guidelines for the selection of structures
ISO 8333:1985 ISO 9826:1990 ISO 9827:1992	BS 3680:Part 4I:1986	V shaped broad crested weirs Parshall and SANIIRI flumes Streamlined triangular profile weirs
ISO 13550 (FDIS)		Vertical underflow gates

## **5 Installation**

General requirements of combined gauging structure / fishpass installations are given in the following clauses.

### **5.1 Requirements for gauging structure / fishpass combinations**

Each of the normative references listed in Section 2 of this Appendix gives the requirements for the installation of gauging structures in channels. There is much commonality between the different structures and the requirements, which can also be applied to gauging structure / fishpass combinations, are summarised in the following sections.

#### **5.1.1 Selection of site**

**5.1.1.1** A preliminary survey shall be made of the physical and hydraulic features of the proposed site, to check that it conforms (or may be made to conform) to the requirements necessary for measurement by a weir.

**5.1.1.2** Particular attention should be paid to the following features in selecting the site:

- a) availability of an adequate length of channel of regular cross-section;
- b) the existing velocity distribution;
- c) the avoidance of a steep channel, if possible;
- d) the effects of any increased upstream water level due to the measuring structure;
- e) conditions downstream including such influences as tides, confluences with other streams, sluice gates, mill dams and other controlling features which might cause submerged flow;
- f) the impermeability of the ground on which the structure is to be founded, and the necessity for piling, grouting or other sealing in river installations;
- g) the necessity for flood banks to confine the maximum discharge to the channel;
- h) the stability of the banks, and the necessity for trimming and/or revetment in natural channels;
- j) the clearance of rocks or boulders from the bed of the approach channel;
- k) the effect of wind; wind can have a considerable effect on the flow in a river or over a weir, especially when these are wide and the head is small and when the prevailing wind is in a transverse direction.

**5.1.1.3** If the site does not possess the characteristics necessary for satisfactory measurement, the site shall be rejected unless suitable improvements are practicable.

**5.1.1.4** If an inspection of the stream shows that the existing velocity distribution is regular, then it may be assumed that the velocity distribution will remain satisfactory after the construction of a weir.

**5.1.1.5** If the existing velocity distribution is irregular and no other site for a gauge is feasible, due consideration shall be given to checking the distribution after the installation of the weir and to improving it if necessary.

**5.1.1.6** Several methods are available for obtaining a more precise indication of irregular velocity distribution. Velocity rods, floats or concentrations of dye can be used in small channels, the latter being useful in checking conditions at the bottom of the channel. A complete and quantitative assessment of velocity distribution may be made by means of a current-meter.

## **5.1.2 Installation conditions**

**5.1.2.1** The complete gauging installation consists of an approach channel, a measuring structure and a downstream channel. The conditions of each of these three components affect the overall accuracy of the measurements.

**5.1.2.2** Installation requirements include such features as weir finish, cross-sectional shape of channel, channel roughness, influence of control devices upstream or downstream of the gauging structure.

**5.1.2.3** The distribution and direction of velocity, determined by the features outlined in 5.1.1, have an important influence on the performance of the weir.

**5.1.2.4** Once an installation has been constructed, the user shall prevent any change which could affect the discharge characteristics.

### **5.1.3 Approach channel**

**5.1.3.1** At all installations the flow in the approach channel shall be smooth, free from disturbance and shall have a velocity distribution as normal as possible over the cross-sectional area. This can usually be verified by inspection or measurement. In the case of natural streams or rivers this can only be attained by having a long straight approach channel free from projections either at the side or on the bottom. Unless otherwise specified in the appropriate clauses, the following general requirements shall be complied with.

**5.1.3.2** The altered flow-conditions due to the construction of the weir might have the effect of building up shoals of debris upstream of the structure, which in time might affect the flow conditions. The likely consequential changes in the water level shall be taken into account in the design of gauging stations.

**5.1.3.3** In an artificial channel the cross-section shall be uniform and the channel shall be straight for a length equal to at least five times its breadth.

**5.1.3.4** In a natural stream or river the cross-section shall be reasonably uniform and the channel shall be straight for such a length as to ensure regular velocity distribution.

**5.1.3.5** If the entry of the approach channel is through a bend or if the flow is discharged into the channel through a conduit of smaller cross-section, or at an angle, then a longer length of straight approach channel may be required to achieve a regular velocity distribution.

**5.1.3.6** There shall be no baffle nearer to the points of measurement than five times the maximum head to be measured.

**5.1.3.7** Under certain conditions, a standing wave may occur upstream of the gauging device, for example if the approach channel is steep. Provided this wave is at a distance of not less than 30 times the maximum head upstream, flow measurement will be feasible, subject to confirmation that a regular velocity distribution exists at the gauging station.

#### **5.1.4 Downstream channel**

**5.1.4.1** The channel downstream of the structure is of no importance as such if the gauging structure or gauging structure / fishpass combination has been so designed that the flow is modular under all operating conditions. A downstream gauge shall be provided to measure tailwater levels to determine if and when submerged flow occurs.

**5.1.4.2** In the event of the possibility of scouring downstream, which phenomenon may also lead to the instability of the structure, particular measures to prevent this happening may be necessary.

**5.1.4.3** A crest tapping and separate stilling well shall be fitted if the weir is designed to operate in a drowned condition or if there is a possibility that the weir may drown in the future.

**5.1.4.4** The latter circumstance may arise if the altered flow conditions due to the construction of the weir have the effect of building up shoals of debris immediately downstream of the structure or if river works are carried out downstream at a later date.

#### **5.1.5 Gauging structure**

**5.1.5.1** The structure shall be rigid and watertight and capable of withstanding flood flow conditions without distortion or fracture. It shall be at right angles to the direction of flow and shall conform to the dimensions and tolerances given in the relevant Standards. Details for each type of weir are given in the appropriate Standard, see Table M.1.

#### **5.1.6 Fishpass structure**

**5.1.6.1** The structure shall be rigid and watertight and capable of withstanding flood flow conditions without distortion or fracture.

**5.1.6.2** The upper section of the fishpass (the first baffle in the case of the Larinier fishpass, see Section 6 of this appendix) shall be constructed with the same precision expected for a measuring weir, see relevant Standards quoted in Table M.1.

#### **5.1.7 Maintenance**

**5.1.7.1** Maintenance of the measuring structure, the fishpass and the approach channel is important to secure accurate continuous measurements of discharge.

**5.1.7.2** It is essential that the approach channel to gauging structure / fishpass combinations should be kept clean and free from silt and vegetation. The float well and the entry from the approach channel shall also be kept clean and free from deposits.

**5.1.7.3** The weir structure and the fishpass shall be kept clean and free from clinging debris and care shall be taken in the process of cleaning to avoid damage to the weir or fishpass.

### **5.1.8 Measurement of head**

**5.1.8.1** Gauging structure / fishpass combinations shall be regarded as compound gauging structures in terms of operation, see ISO 14139:2000.

**5.1.8.2** The measurement of head shall normally be carried out at the gauging structure and the appropriate head to be applied to the fishpass shall be deduced in accordance with ISO 14139:2000.

**5.1.8.3** Exceptionally, a second head may be used upstream of the fishpass. This will reduce uncertainties in the computed total flow.

**5.1.8.4** Head gauges shall be zeroed to the crest of weirs or to the invert level of flumes. Accuracy in zeroing gauges is very important at low flows.

## **5.2 Requirements specific to the fishpass**

### **5.2.1 Introduction**

The swimming performance of fish depends on many factors including:

- species
- individual size and ability
- water temperature
- water depth
- water velocity
- water quality
- turbulence
- motivation

It is thus a complex subject with many variations. The data available are variable in both quantity and quality, and complex to interpret. Furthermore the effectiveness of a fishpass in terms of ease of passage depends on a suitable match between the type of fishpass and the particular species of fish wishing to migrate. It is not within the scope of this Standard to cover this complex subject in detail. Instead, basic requirements which apply to a range of species of fish and a range of types of fishpass are identified to help those designing gauging structure / fishpass combinations.

### **5.2.2 Guidelines for basic parameters of fishpasses**

Guidelines for maximum water velocities within, and head drops across, fishpasses are given in Table M.2.

**Table M.2 Guidelines for maximum water velocities within, head drops across and lengths of fishpasses**

Pass Parameters		Species			
		Coarse fish	Brown Trout	Sea Trout	Salmon
Pool Pass	Max. velocity (m/s)	1.4 - 2.0	1.7 - 2.4	2.4 - 3.0	3.0 - 3.4
	Max. head drop (m)	0.1 - 0.2	0.15 - 0.3	0.3 - 0.45	0.45 - 0.6
Baffled Pass	Max. velocity (m/s)	1.1 - 1.3	1.2 - 1.6	1.3 - 2.0	1.3 - 2.0
	Length of pass (m)	8 - 10	8 - 10	10 - 12	10 - 12

### 5.2.3 Location and attraction flows

In many respects the most significant problem in passing fish, either upstream or downstream, is that of attracting the fish into the fishpass facility.

#### 5.2.3.1 Location

At an existing gauging structure a fishpass shall be introduced where migrating fish are observed either to congregate, or else attempt to pass, when actively trying to move upstream. At new installations a fishpass shall be installed if fish are observed to migrate through the reach. This shall be achieved using visual, acoustic or radio tracking methods.

The fishpass shall be located near one or other banks wherever practicable since this is the preferred migration route for many species. This location facilitates monitoring and maintenance. Security risks may need to be addressed. See also Sections 5.2.4 and 5.2.5.

#### 5.2.3.2 Attraction flows

The jet of water issuing from the fishpass shall be discernible to the fish. Exit velocities shall be in excess of 0.75 m/s and preferably in excess of 1.5 m/s for salmonids.

The discharge through the fishpass shall be large enough to attract fish towards the downstream entrance. There are various criteria for this including:

- 1 to 5 per cent of the river flow during the migration period (larger watercourses)
- 5 to 10 per cent of the annual daily flow of the river (smaller watercourses)
- a flow equal to the river flow which is exceeded 97 per cent of the time



#### **5.2.4 Downstream entry to fishpass**

The downstream entrance to the fishpass shall be located at the most upstream position which is easily accessible to the fish, for example close to the downstream truncation of a gauging structure. The downstream entry to the fishpass shall not be in areas of either re-circulating flows or highly turbulent flows. A vertical slot entry shall be installed such that a significant jet of water flows from the fishpass over a range of river flows.

#### **5.2.5 Upstream exit from fishpass**

The upstream exit from the fishpass shall not be located where there is a danger of fish being immediately swept back downstream. A submerged orifice exit will help to minimise the ingress of floating and demersal trash. The size of the orifice shall be large enough to avoid significant head losses which would complicate flow measurement. The edges of the orifice shall be rounded to minimise head losses.

### **6 Fishpass performance**

#### **6.1 General**

**6.1.1** Only fishpass types which have been subjected to rigorous hydrometric testing and which have flow performance data which is of an accuracy comparable with the gauging structure are covered by this Standard. Rigorous hydrometric testing is defined as the determination of coefficients of discharge in large scale laboratory facilities using volumetric or weighing techniques to determine discharge. Typically the coefficient of discharge shall have been determined with an uncertainty of less than 2 percent at the 95 per cent confidence level. Such data are available for the super-active Larinier fishpass with 100mm baffles. (Other types will be added when published information becomes available.)

#### **6.2 Larinier fishpass**

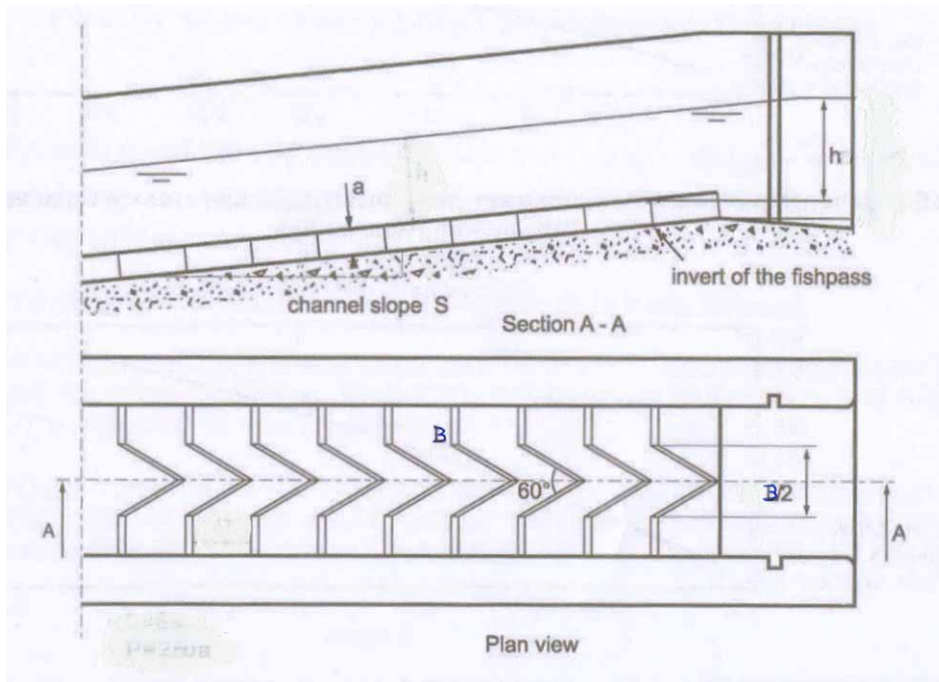
##### **6.2.1 Description**

The Super-active Larinier fishpass with 100mm baffles is shown in Figure M.1.

The fishpass has the following features:

- Width of one unit,  $B = 600\text{mm}$
- Width of echelon section of baffles,  $B/2 = 300\text{mm}$
- Height of baffles,  $a = 100\text{mm}$
- Longitudinal slope of unit,  $S = 15\%$

Larinier fishpass units shall be juxtaposed in multiples of 1.0, 1.5, 2.0, 2.5 etc. when larger fishpass flows are required.



**Figure M.1 Super-active Larinier fishpass with 100mm baffles**

[See Larinier M, Porcher J P, and Travade F 2002. *Fishways: biological basis, design criteria and monitoring*. Bulletin Francais de la Peche et de la Pisciculture, 364, 208pp.]

## 6.2.2 Limitations

**6.2.2.1** The upper and lower limits for flows (heads) which provide satisfactory flow conditions for fish migration are as follows:

- Minimum upstream head,  $h = 0.18\text{m}$  ( $0.087 \text{ m}^3/\text{s}$  per Larinier unit or  $0.145 \text{ m}^3/\text{s}$  per metre width)
- Maximum upstream head,  $h = 0.60\text{m}$  ( $0.498 \text{ m}^3/\text{s}$  per Larinier unit or  $0.830 \text{ m}^3/\text{s}$  per metre width)

## 6.2.3 Modular flow calibration

### 6.2.3.1 Discharge equations

The modular flow equation for the Larinier fishpass, is:

$$Q = b C_{de} (g)^{0.5} (H_{1e})^{1.5} \quad (\text{M.1})$$

where

$$H_{1e} = H_1 - k_h = h_1 + (v_1)^2/2g - k_h \quad (\text{M.2})$$

where

$b$  (m) = crest breadth measured at transverse section of upstream baffle

$C_{de}$  = dimensionless coefficient of discharge

$g$  ( $\text{m}/\text{s}^2$ ) = acceleration due to gravity

$h_1$  (m) = upstream gauged head relative to transverse section of upstream

Larinier baffle

$H_1$  (m) = upstream total head relative to transverse section of upstream Larinier baffle

$H_{1e}$  (m) = effective upstream total head relative to transverse section of upstream Larinier baffle

$k_h$  (m) = head correction factor taking into account fluid property effects

$Q$  (m<sup>3</sup>/s) = flow

$v_1$  (m/s) = velocity of approach at tapping location

### 6.2.3.2 Coefficient of discharge

The coefficient of discharge is shown in Figure M.2.

The following values of  $C_{de}$  shall be used in Equation M.1:

Phase 1 (  $0.02\text{m} < h < 0.08\text{m}$  )

$$C_{de} = 0.50 + 2.50 ( h - 0.02 ) \quad (\text{M.3})$$

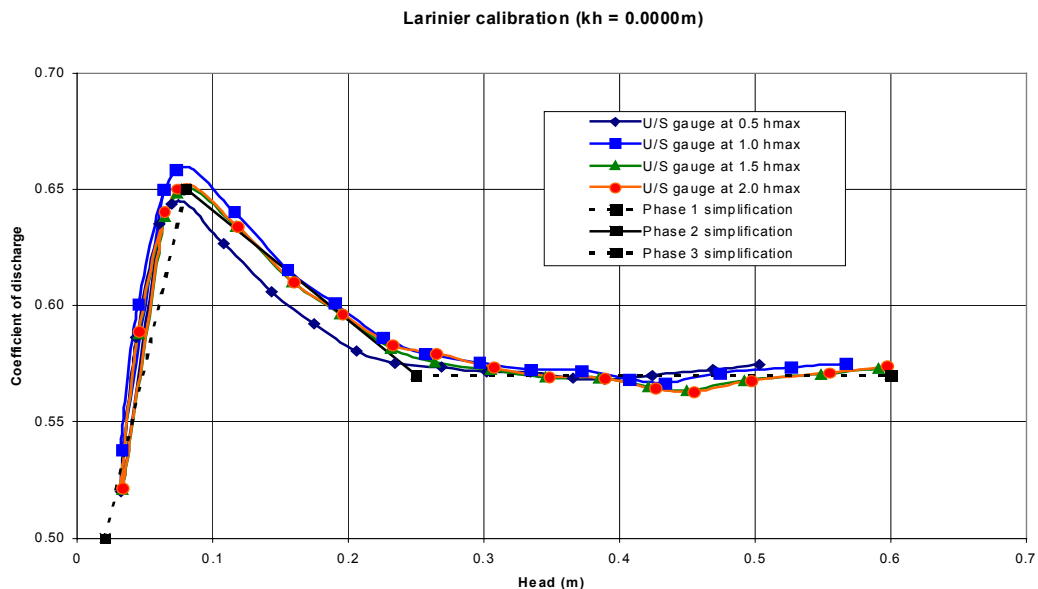
Phase 2 (  $0.08\text{m} < h < 0.25\text{m}$  )

$$C_{de} = 0.65 - 0.47 ( h - 0.08 ) \quad (\text{M.4})$$

Phase 3 (  $h > 0.25\text{m}$  )

$$C_{de} = 0.57 \quad (\text{M.5})$$

The value of  $k_h$  used in Equation M.2 should be zero.



**Figure M.2 Coefficient of discharge for super-active Larinier fishpass**

The hydrometric calibration of the Larinier fishpass was carried out using volumetric flow measurement techniques and the uncertainty in the derived coefficient of discharge is +/- 2%.

## 6.2.4 Modular limit

The modular limit of the Larinier fishpass varies with head (flow). The modular limit is the ratio of the downstream to upstream heads at which there is a reduction from the modular flow of one percent. Equation M.6 shall be used to determine its value.

$$\text{Modular limit} = (20 + 60 h_1) \% \quad (\text{M.6})$$

Where  $h_1$  is the upstream head in metres.

## 7 Computation of discharge

### 7.1 General principles

A compound gauging structure, as covered by the International Standard ISO 14139:2000, comprises two or more individual structures, operated in parallel and separated by divide piers. These divide piers must be high enough to segregate the individual structures up to the highest gauged flow. Each individual structure is referred to as a “section” of the compound structure. The individual structures which can be used in a compound gauging weir are specified in Table M.1.

In the modular flow range, discharges depend solely on upstream water levels, and a single measurement of upstream head is required. In the drowned flow range, discharges depend on both upstream and downstream water levels, and two independent head measurements are required. These are (1) the upstream head and (2) either a) the head measured in the crest tapping for a triangular profile weir (two dimensional or flat-V) or b) the head measured within the throat of a Parshall flume or c) the head measured in the tailwater for other types of gauging structure.

### 7.2 Discharge calculations

Discharge calculations follow the detailed method described in the Standard for compound weirs, ISO 14139:2000. This Standard is essential for those designing gauging structure / fishpass combinations and it is inappropriate to repeat all the details here.

#### 7.2.1 Modular flow conditions

**7.2.1.1** Modular flow calibrations are based on measurements of upstream water levels. Where a single (non-compound) structure is used, the recorded water level is used directly in the computation of discharge. However, it is not usually economic to measure water levels upstream of each individual section of a compound weir, and hence it is necessary to make assumptions about the relationships between flow conditions at the various sections when calculating the total flow.

**7.2.1.2** Research has shown that the total head level can be assumed constant

over the full width of a compound measuring structure and that it can be obtained by adding to the observed water level the velocity head appropriate to the individual section at which the water level is observed. Thus the basis of the method of computing the total discharge over a compound structure is to calculate the total head level at the individual section at which the water level is measured, as if it were a simple non-compound structure, and to use the same value of total head level to calculate individual discharges at other sections.

Successive approximation or coefficient of velocity techniques are applied at the section of the structure where the water level is recorded to convert gauged heads to total heads. Discharge equations in terms of total heads are used at other sections of the compound structure and no conversions are required. An outline example calculation is given in Section 9 of this appendix.

## **7.2.2 Non-modular (drowned) flow conditions**

**7.2.2.1** When a compound structure is designed to operate in the non-modular flow range, a triangular-profile weir with a crest tapping shall be used in those sections of the compound weir which are likely to drown.

**7.2.2.2** Upstream total heads are determined as for the modular flow case but discharges at those individual sections of the compound gauging structure which are drowned are obtained by considering both the upstream total head and the crest tapping pressure.

## **8 Computation of uncertainty of measurement**

### **8.1 General principles**

Uncertainty calculations follow the detailed method described in the Standard for compound weirs, ISO 14139-2000. This Standard is essential for those designing gauging structure / fishpass combinations as it is inappropriate to repeat all the details here.

#### **8.1.1 Overall uncertainties**

The total uncertainty of any flow measurement can be estimated if the uncertainties from various sources are combined. The assessment of these contributions to the total uncertainty will indicate whether the rate of flow can be measured with sufficient accuracy for the purpose in hand. This clause is intended to provide sufficient information for the user of this Standard to estimate the uncertainties of measurements of discharge when read alongside ISO 14139:2000.

The error is the difference between the true rate of flow and that calculated in accordance with the equations used for calibrating the measuring structure, which is assumed to be constructed and installed in accordance with this Standard. The term *uncertainty* is here used to denote the deviation from the true rate of flow within which the measured flow is expected to lie some 19 times out of 20 (with 95 % confidence limits).

### **8.1.2 Sources of error**

The sources of uncertainty in the discharge measurement for each individual section of the compound structure are as given in the uncertainties sections of the International Standards relating to the appropriate type of structure (see Table M.1). Additional uncertainties arise due to the method used for estimating water levels or total head levels at individual sections, when (as is usual) these are not measured separately at each section. Available evidence is limited, but it suggests that the percentage uncertainty in discharge associated with transposing upstream water levels or total head levels is random, with a magnitude within the range of +/- 5%. In particular cases, more reliable estimates can be made of this value by making field or laboratory observations. For cases involving drowned flow, little information is available about the additional uncertainty in discharge associated with estimating downstream water levels or total head levels. A value of +/- 10% shall be assumed until further evidence becomes available.

## **8.2 Uncertainty calculations**

Uncertainty calculations follow the detailed method described in the Standard for compound weirs, ISO 14139:2000. The combination of uncertainties to give overall uncertainty in total discharge involves the following steps:

### **8.2.1 Step 1**

For the section at which the upstream water level is measured, the percentage uncertainty in the section flow is calculated by reference to the International or British Standard appropriate to that type of weir or flume (see Table M.1).

### **8.2.1 Step 2**

The percentage uncertainties in the flows at the ungauged sections are similarly computed, assuming the same uncertainty on water level measurement (not percentage) as in 1. Uncertainties due to transferring water levels or heads are ignored at this stage of the calculation.

### **8.2.2 Step 3**

The uncertainty in the total flow is the weighted mean of the uncertainties for the flows at the individual sections, with the inclusion of terms for the uncertainty of transposing water levels or heads.

### **8.2.3 Step 4**

If no sections of the weir are submerged, then the uncertainty associated with estimating downstream water levels is omitted in all cases, and the uncertainty in transposing upstream water levels is omitted for any sections at which the upstream water level is measured.

## 8.2.4 Step 5

If the weir is submerged, then the uncertainty associated with estimating downstream water levels is omitted for any sections at which the crest pressure is measured, but included for any other sections. For cases of submergence it does not follow automatically that the uncertainty in transposing upstream water levels is to be omitted at sections where the upstream water levels are measured. A transfer of upstream heads as well as downstream heads may be involved in assessing crest pressures at such sections.

Full details are given in ISO 14139:2000.

## 9 Example

### 9.1 Installation

In this example the installation comprises:

1. A flat-V weir built to BS 3680:Part 4G:2002, crest elevation 100.25mAD, crest breadth 10.00m
2. A twin unit super-active Larinier fishpass, elevation of the transverse section of the uppermost baffle 100.25mAD, width 1.20m.
3. A channel bed level of 100.00mAD both upstream and downstream of the gauging structure / fishpass combination.
4. One head measurement is provided at the flat-V weir.

In this example the following uncertainties in measurement are assumed:

1. Overall uncertainty in cross slope of the flat-V weir, +/- 0.2%
2. Overall uncertainty in head measurement at the flat-V weir, +/- 3mm
3. Overall uncertainty in head correction factor for the flat-V weir, +/-0.2mm
4. Overall uncertainty in coefficient of discharge of flat-V weir, +/- 3.2%
5. Overall uncertainty in the crest breadth of the Larinier fishpass, +/- 6mm
6. Overall uncertainty in the coefficient of discharge of the Larinier fishpass, +/- 2%
7. Additional uncertainty due to the transfer of head to the ungauged fishpass, +/- 5%

### 9.2 Flow conditions

In this example the gauged head at the flat-V weir is 0.400m (100.650mAD) and the observed tailwater level is 100.400mAD (0.150m above the flat-V weir and the fishpass).

### 9.3 Computation of discharge

#### 9.3.1 Modularity

The submergence ratio at the flat-V weir is:

$$\text{Submergence ratio} = ( 0.150 / 0.400 ) \times 100 = 38\%$$

The submergence ratio at the fishpass is:

$$\text{Submergence ratio} = ( 0.150 / 0.400 ) \times 100 = 38\%$$

BS 3680:Part 4G:2002 gives the modular limit of the flat-V weir as 70% and equation M.6 gives a modular limit of 44% for the fishpass under these particular flow conditions. Therefore, the gauging structure / fishpass combination is operating under modular flow conditions.

### **9.3.2 Flow over the flat-V weir**

Using BS 3680:Part 4G:2002 the flow over the flat-V weir is computed as  $1.581\text{m}^3/\text{s}$ . The upstream gauged head,  $h_1$ , is 0.400m. The upstream total head,  $H_1$ , is 0.403m.

### **9.3.3 Flow through the fishpass**

Using equations M.1 and M.5, the flow through the fishpass is  $0.548\text{m}^3/\text{s}$ .

### **9.3.4 Total flow**

The total flow through the gauging structure / fishpass combination is:

$$\text{Total flow} = 1.581 + 0.548 = 2.129\text{m}^3/\text{s}.$$

## **9.4 Uncertainty of measurement**

### **9.4.1 Uncertainty in flow over the flat-V weir, see 8.2.1**

Using BS 3680:Part 4G:2002 the overall uncertainty in the measured head is 0.83%. The overall uncertainty in the flow over the flat-V weir is 3.90%.

### **9.4.2 Basic uncertainty in flow through the fishpass, see 8.2.2**

The Larinier fishpass has a near horizontal crest at the top baffle and hence the hydraulic performance approximates to a two dimensional weir such as the Crump weir, BS 3680:Part 4B: 1986. Uncertainties for the fishpass are calculated according to the methods described in this standard.

Using BS 3680:Part 4B: 1986 and the same overall uncertainty for measured head of 0.83%, the overall uncertainty in flow for the fishpass is 2.41%.

### **9.4.3 Uncertainty in total flow, see 8.2.3**

ISO 14139:2000 indicates how uncertainties are to be combined and prescribes an additional uncertainty of 5% for transposing water levels or heads to the fishpass. In this example the overall uncertainty is:

$$\text{Overall uncertainty} = +/- [ 1 / 2.129 ] [ 1.581 \times 3.90 + 0.548 \times \text{SQRT} ( 2.41^2 +$$



$$5.0^2 ) ] = 4.33\%$$

#### **9.4.4 Reduction in overall uncertainty if second head gauge were to be installed upstream of the fishpass**

A second head gauge would remove the uncertainty in transposing heads from the gauging weir to the fishpass. In this case the overall uncertainty would be:

$$\text{Overall uncertainty} = \pm [ 1 / 2.129 ] [ 1.581 \times 3.90 + 0.548 \times 2.41 ] = 3.52\%$$