

Detailed analysis from the first phase of the Energy Saving Trust's heat pump field trial

Evidence to support the revision of the MCS Installer Standard
MIS 3005 Issue 3.1

March 2012

Authors:

Dr. Penny Dunbabin

DECC

3–8 Whitehall Place

London

SW1A 2AW

penny.dunbabin@decc.gsi.gov.uk

0300 068 5575

Chris Wickins

DECC

3–8 Whitehall Place

London

SW1A 2AW

chris.wickins@decc.gsi.gov.uk

0300 068 6880

Preface

The Energy Saving Trust monitored 83 heat pumps in residential properties across Great Britain from April 2009 to April 2010. Findings from Phase I of this project were published in a report entitled *Getting warmer: a field trial of heat pumps* on the Energy Saving Trust's website in September 2010.¹

Analysis from the first phase of the Energy Saving Trust's heat pump trial: April 2009 to April 2010 examines a number of these heat pump installations in more detail, paying particular attention to the factors that influence system performance. As a result of some of the analysis presented here, the Microgeneration Certification Scheme (MCS) standards for heat pump installation² have been updated.

Aimed primarily at heat pump manufacturers, installers and training and certification bodies, this report is specialist in nature. It will also be of interest to academics, building services engineers and low-carbon heating consultants.

Sections 5 and 6 present additional analysis of data collected from Phase I of the ongoing Energy Saving Trust field trial. The sample is slightly different to that reported in *Getting warmer* as six sites with solar thermal panels have been included, and three sites with faulty heat meters were removed.

Sections 7 and 8 are concerned with detailed site-by-site analysis to determine the reasons for good or poor performance. The insights from this analysis have formed the basis for the development of the new MCS heat pump installation standards.

Several interventions have been carried out since these data were recorded. The impacts of these interventions have been monitored during a continuing second year. A report will be published in late 2012 which will discuss their effects on performance.

Section 11 of this report describes other studies in this area and future work.

¹ Energy Saving Trust (2010) *Getting warmer: a field trial of heat pumps*
www.energysavingtrust.org.uk/Media/node_1422/Getting-warmer-a-field-trial-of-heat-pumps-PDF

² Microgeneration Certification Scheme *Requirements for contractors undertaking the supply, design, installation, set to work commissioning and handover of microgeneration heat pump systems*, MIS 3005 Issue 3.1.

Summary

The Energy Saving Trust (EST) monitored 83 heat pumps in residential properties across Great Britain from April 2009 to April 2010.

The sample included a large number (44) of site permutations, broadly representative of the market at the time of commissioning the project, and included the following installation types:

- air-source and ground-source heat pumps
- heat pumps installed in private and social housing properties
- heat pumps installed in new-build and retrofit properties
- heat pumps providing heating only
- heat pumps providing heating and hot water
- heat pumps installed with different heat delivery systems: under-floor heating and/or radiators
- systems combined with solar water heating
- grant funded through the Low Carbon Buildings Programme and the Scottish Communities and Householder Renewables Initiative.

Fifteen manufacturers' heat pumps were included in the trial.

The sample included sites in domestic residential properties only. A number of sites have been identified in this report by their site number to facilitate the discussion, however no further information about each site, including the manufacturer or site location, has been disclosed in this report.

Since the EST's report, '*Getting Warmer – A field trial of heat pumps*' was published, detailed analysis of heat pump performance, on a site-by-site basis, has been carried out by the Department of Energy and Climate Change and the Energy Saving Trust's technical contractors, Gastec at CRE and EA Technology. Salient examples are presented in this report. As a result of this analysis, system efficiency figures have been revised for a small number of heat pumps.

This site-by-site analysis has formed the basis of extensive discussions with the heat pump industry. As a result, the Microgeneration Certification Scheme (MCS) has drawn up new standards for the installation of heat pumps with <45kW heating capacity. These new MCS standards were launched in September 2011.

This report is divided into nine sections:

- presentation of methodology

- discussion of system boundaries
- procedures for data checking
- histograms of system performance
- analysis of system performance as a function of emitter type and hot water production
- examples of good performance
- examples of poor system design or installation, leading to poor performance
- analysis of boreholes and ground loops across the sample of ground-source heat pumps
- conclusions and implications for design and installation standards
- future work.

The report should be read in conjunction with other analysis from the field trial, namely:

- laboratory tests to investigate the effect of thermostatic radiator valves on heat pump performance³
- analysis of glycol samples from a selection of ground-source heat pumps in the trial, and
- revised guidance for the design and installation of heat pump systems, MIS 3005 Issue 3.1,⁴ Microgeneration Certification Scheme, February 2012.

Funding and Support: Acknowledgements

Phase I of this project was developed by the Energy Saving Trust and delivered with funding from a wide range of stakeholders including the UK's main energy suppliers: EDF Energy, NPower, British Gas, Scottish Power, Scottish & Southern Energy, E.On UK, and NIE Energy; the Scottish Government; the Department of Energy and Climate Change; the North West Regional Development Agency; and heat pump manufacturers and installers including: Danfoss UK, NIBE, Mitsubishi Electric, Earth Energy, Worcester Bosch and Baxi Group. These funders were all represented on the project's advisory group and were influential in the trial's development and site selection. They have also provided technical input and oversight and input into the data collection methodology. DECC and the EST are most grateful for their funding and significant in-kind support, without which the first phase of this project could not have been completed.

This report has been produced after a successful period of analysis and industry engagement. The field trial project team would like to thank all those who have contributed to extracting useful information from the data, particularly those

³ Green R and Knowles T (2011) *The effect of Thermostatic Radiator Valves on heat pump performance*. Energy Saving Trust and EA Technology Consulting. www.decc.gov.uk/assets/decc/11/meeting-energy-demand/microgeneration/3531-effect-radiator-valves-heat-pump-perf.pdf

⁴ www.microgenerationcertification.org/installers/installers

manufacturers who have carefully examined, challenged and subsequently used the data they have been presented with (and openly shared their own data) to improve the understanding of the team. DECC would also like to thank the Energy Saving Trust, and its contractors Gastec at CRE, EA Technology and the Energy Monitoring Company for many hours of painstaking work. Finally, we would like to thank all those who participated in the consultation on the revised Microgeneration Certification Scheme standards for their time and efforts.

An additional phase of in-situ monitoring is currently in progress and the Energy Saving Trust intends to report on these findings later in 2012.

Table of Contents

Preface	1
Summary	2
Funding and Support: Acknowledgements	3
1. Site Selection and Installation Procedure	8
1.1. Site Selection	8
1.2. Installation of Monitoring Equipment	9
1.3. The Data Monitoring Specification	10
1.4. Variations on the Monitoring Specification	12
1.5. Heat Balances	13
2. System Boundaries in the Energy Saving Trust's Field Trials	14
3. Data Checking	18
4. Analysis	18
5. Additional Analysis of Distributions of System Efficiencies for Ground- and Air-source Heat Pumps	19
5.1. Revision of Estimated and Calculated Efficiencies	19
5.1.1. Air-source Heat Pumps	19
5.1.2. Ground-source Heat Pumps	20
5.2. Re-analysis of Air-Source Heat Pump Data Supplied by 'Manufacturer A'	20
5.3. Analysis of Sites with Solar Thermal Inputs	21
5.4. Revised Analysis of the Site with an Oil Boiler (454)	22
5.5. Revised Histograms of System Efficiency of Air- and Ground-source Heat Pumps	23
6. Analysis of System Efficiency as a Function of Emitter Type and Domestic Hot Water Production	26
6.1. Ground-source Heat Pumps	26
6.2. Air-source Heat Pumps	27
7. Examples of Good Performance	31
7.1. Ground-source Heat Pump Supplying Under-floor Heating Only, Site 430	31
7.2. Ground-source Heat Pump Supplying Under-floor Heating Only, and Hot Water, Site 439	33
7.3. Ground-source Heat Pump Supplying Radiators, Site 419	36
7.4. Air-source Heat Pump Supplying Radiators, Site 443	36

7.5.	Low Cycling, Site 460.....	38
8.	Case Studies Relating to Under-performance	41
8.1.	Under-sizing of Heat Pump (Example I)	42
8.2.	Under-sizing of Heat Pump (Example II)	44
8.3.	Poor Design of Ground Loop.....	46
8.4.	Leaking Ground Loop	49
8.5.	Ground Loop Temperature Difference Increasing.....	50
8.6.	Incorrect Sizing of Domestic Hot Water Cylinder	52
8.7.	High Losses from the Domestic Hot Water Cylinder	53
8.8.	Inadequate Insulation of Cylinders and Pipework.....	55
8.9.	Central Heating Flow Temperature Too High: Radiator System.....	58
8.10.	Central Heating Flow Temperature Too High: Under-floor System	60
8.11.	Excessive Use of Circulation Pumps.....	61
9.	Examination of Boreholes and Ground Loops in the Trial	63
10.	Revision of MIS 3005 Installation Standards for Heat Pumps	64
10.1.	Heat Pump Sizing	65
10.1.1.	Explanation of Approach to Sizing of Heat Pumps.....	70
10.1.2.	Effects of Over- and Under-sizing Heat Pumps on Performance.....	72
10.1.3.	Effects of Over- and Under-sizing Heat Pumps on the Grid.....	75
10.1.4.	Practical Implications for Sizing Heat Pumps.....	77
10.2.	Selection of Heat Emitters	77
10.3.	Design of Ground Loops.....	79
10.4.	Domestic Hot Water Production and Storage	85
10.5.	General Considerations.....	86
11.	Future Work.....	86
11.1.	Second Year of the Energy Saving Trust Heat Pump Field Trials	86
11.2.	Other Heat Pump Monitoring Projects.....	87
	APPENDIX 1: INSTRUMENTATION USED	88
	APPENDIX 2: PROCEDURES FOR DATA CHECKING	92
	APPENDIX 3: APPENDIX B FROM THE REVISED MIS 3005 STANDARDS: MET OFFICE DATA 1981–2010	99
	APPENDIX 4: EFFECT OF UNCERTAINTY IN BUILDING HEAT LOSS CALCULATIONS ON SIZING OF HEAT PUMPS.....	102
	APPENDIX 5: HEAT EMITTER GUIDE.....	107

APPENDIX 6: APPENDIX C FROM MIS 3005 ISSUE 3.1: VALUES FOR THERMAL CONDUCTIVITY OF DIFFERENT TYPES OF ROCK.....	108
APPENDIX 7: EXTRACT FROM MCS 022 – GROUND HEAT EXCHANGER LOOK-UP TABLES. SUPPLEMENTARY INFORMATION TO MIS 3005 ISSUE 1.0: DRAFT EXAMPLE OF A VERTICAL GROUND LOOP LOOK-UP TABLE.....	111

1. Site Selection and Installation Procedure

1.1. Site Selection

The Energy Saving Trust (EST) identified a sample of heat pump installations that were representative of the UK heat pump market in Q1 of 2008. Details of potential sites were gathered from grants programmes such as the Low Carbon Buildings Programme (LCBP) and the Scottish Community and Householder Renewables Initiative (SCHRI). Further sites were identified with the help of housing associations, energy suppliers and the heat pump industry. The Energy Saving Trust contacted more than 150 householders to invite participation in the field trial, and a final sample of 83 properties was chosen by December 2008. The sample included a mix of air- and ground-source heat pump systems (around a third of the sample being air-source), installed in private and social housing, and included products from 15 manufacturers.

A number of key criteria were used to identify the suitability of a site:

- customer willingness to participate
- type of heat pump
- manufacturer, make and model of heat pump
- heating delivery system (radiators, under-floor, etc.)
- property type – age, construction, tenure, etc.
- energy rating of property
- geographical location.

Once a representative shortlist of sites had been drawn up, telephone contact was made with the resident to identify the technical feasibility of monitoring each site. Residents were interviewed to discuss their household's commitment to the trial and confirm the requirements for participation, including:

- the rationale for undertaking an in-situ study of the performance of heat pumps
- the methodology, and an explanation of the monitoring equipment to be installed
- an indication of the timescale of the project
- the householder's availability for site visits
- whether the site had a global system for mobile communications (GSM) signal, to allow the remote transfer of data.

These interviews allowed the project team to assess each installation to determine whether the site would be suitable, whether it used standard heat pumps and heating systems (rather than bespoke ones) and to establish the plumbing and electrical intervention required.

After drawing up a technically feasible shortlist of sites with resident buy-in, the Energy Saving Trust identified a final sample broadly representative of the market and, whenever possible, geographically clustered. The clusters were of two types:

- groups of similar or, where possible, identical machines in close proximity. These sites were useful for identifying variance between similar heat pumps operating in similar properties, and were generally provided by housing associations.
- clusters of different heat pumps within a reasonably small geographical area. This enabled the team to monitor as many heat pump types as possible, maximising the value of the funding available to the project.

Once a shortlist of sites was in place, the installation and monitoring contractors – EA Technology and Gastec at CRE – undertook site surveys to ensure suitability for monitoring. Site surveys involved:

- a survey of the heat pump and heating system, to enable a detailed schematic of the system to be drawn
- a Reduced Standard Assessment Procedure (RdSAP) survey on the property to assign an energy rating
- a check of the GSM signal, to ensure that remote data transfer would be possible
- confirming the objective of the trial to the householder, aided by examples of equipment
- answering any questions from the householder.

Some installations were rejected on the grounds that their systems were too complex to be representative of a typical installation in the UK, and would require an excessive amount of metering. Others were rejected after consultation with the manufacturer or distributor because of potential disruption to the system from the heat meters, with the resulting pressure drop restricting water flow rates.

1.2. Installation of Monitoring Equipment

Once a site was deemed suitable for participation in the field trial, a contractor installed heat and electricity meters. The plumbing and electrical works differed from site to site and from cluster to cluster. At housing association sites, only contractors approved by the association were used to install heat meters, whereas at other sites

this work was carried out by the original installers of the heat pump, or other local installers approved by the heat pump's manufacturers or distributors.

The installer at each site was provided with instructions and a schematic of the system with the position of the meter clearly marked. Every installer was also met by a member of the monitoring team prior to undertaking any installations, to discuss the practicalities. A member of the monitoring team visited the property after the meters had been installed, to connect up the monitoring kit and check on the work of the installers.

Some problems occurred during the installation of heat metering equipment – incorrect positioning of meters being the most common fault – even when the contractors had prior experience of installing monitoring equipment. Six sites were removed from the trials for this reason, and instruments were replaced on a further five sites.

In some instances, site surveys allowed heat pump installers to identify some of the shortcomings of existing installations (for example, excessive external pipe runs). In a number of these cases, the identification of shortcomings resulted in alterations to systems, including, in one case at a housing association, the complete reinstallation of the heat pumps. In this particular case it was decided to not include the sites in the trial, owing to the timescales needed to reinstall the heat pumps.

1.3. The Data Monitoring Specification

The technical monitoring specification used to collect data from the heat pump field trial sites was developed by the Energy Saving Trust and subject to peer review in the first half of 2008 by UK and EU heat pump experts in the Department of Energy and Climate Change (DECC), academia and the heat pump industry. The original monitoring specification for the trial is illustrated in Figure 1. The objective of the field trial was to determine the efficiency of the entire heating system, denoted as 'system efficiency' in *Getting warmer*. As shown, this requires three principal types of energy measurement to establish the operating system efficiencies:

- the electricity consumed by the heat pump and any immersion heating elements, and by the circulation pumps on the central heating side (shown with the symbol (E) in Figure 1)
- the heat delivered to the space heating (shown with the symbol (H) in Figure 1)
- the heat delivered for domestic hot water **used by the householder** (also shown with the symbol (H) in Figure 1).

In some cases, additional heat meters were installed to measure the heat transferred from the heat pump to the domestic hot water cylinder. This is discussed further in Section 1.5.

The electricity consumption includes the energy input to the compressor and controls, plus either the circulating pump(s) for the ground coil (in the case of ground-source heat pumps) or the outdoor fan (in the case of air-source heat pumps). The electricity input to the central heating circulating pump is often supplied via the heat pump control unit. Where possible, this measurement has been taken separately so that it can be excluded from the calculations (as per the Drafter European Standard, prEN15316-4-2), allowing direct comparison with other technologies. Circulation pump consumption is not normally included, for example, in quoted boiler efficiencies.⁵

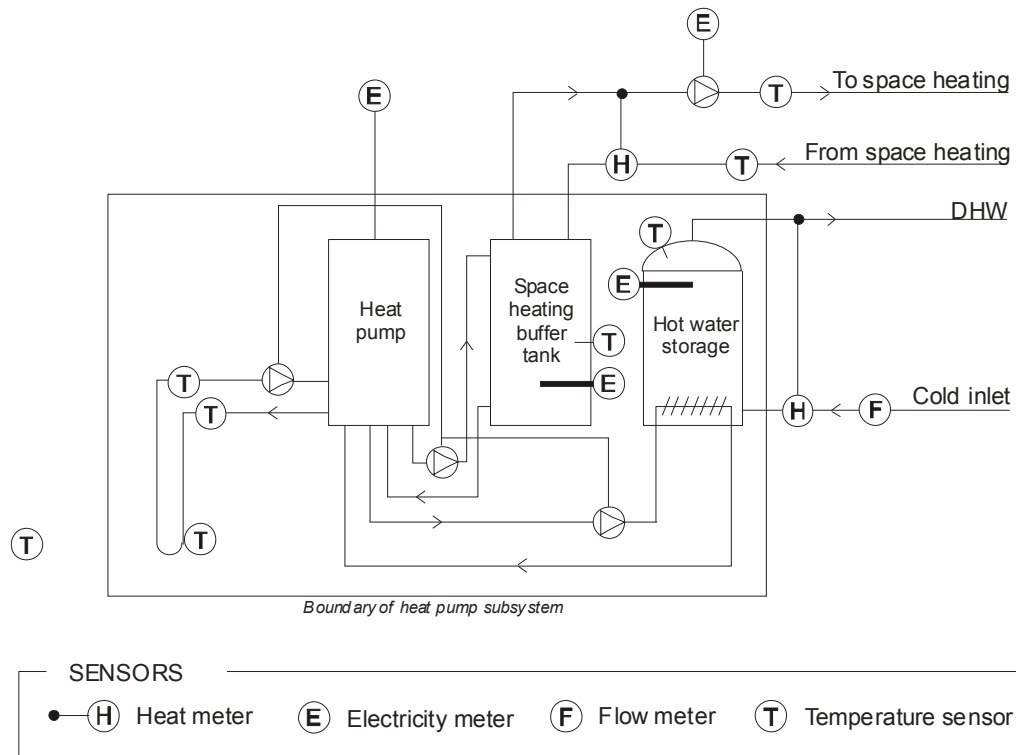

Figure 1: Original generic monitoring specification, as agreed in the technical monitoring specification document

The specification required several other measurements to be taken to determine the overall performance of the heat pump. These are, in the main, factors that can both

⁵In DECC's condensing boiler field trials, however, the electricity usage of the circulation pumps was included in calculations of system efficiency. Gastec at CRE/AECOM/EA Technology (2009) *Final Report: In-situ monitoring of efficiencies of condensing boilers and use of secondary heating*. DECC and Energy Saving Trust. www.energysavingtrust.org.uk/uk/Publications2/Housing-professionals/Heating-systems/In-situ-monitoring-of-efficiencies-of-condensing-boilers-and-use-of-secondary-heating-trial-final-report

influence performance and allow data to be normalised to standard operating conditions. They cover:

- heat source temperatures
- heat sink temperatures, including central heating (CH) flow and return temperatures and domestic hot water (DHW) temperatures
- room temperatures
- outdoor ambient temperatures.

In the case of ground-source heat pumps, the heat source temperatures required are:

- the ground temperature at a distance from the heat extraction point
- the ground temperature close to the ground loop
- flow and return temperatures on the heat source loops, so that the ground loop design can be assessed.

In the case of air-source heat pumps, only the air inlet temperature is required.

Knowledge of the heat sink temperatures for central heating and domestic hot water is important, as these temperatures have a large impact on the performance of the heat pump. Variations in heating load, associated with varying external conditions, mean that the temperature at which the central heating is delivered will vary. The temperature at which domestic hot water is required will vary less, but, depending on the system design, it may differ significantly from any space heating requirement.

The internal (room) temperatures and hot water delivery temperatures were measured to determine whether or not the system provides the householder with adequate comfort and hot water.

External temperature was measured since this is the main cause of variation in heat load over the seasons.

1.4. Variations on the Monitoring Specification

Heat pumps are produced and installed to a wide variety of specifications. One simple generic monitoring specification cannot adequately meet the demands of all systems. Therefore, additional metering and temperature measurements were investigated and included where appropriate.

The main variations in monitoring equipment from the original specification are listed below:

- The heat supplied by the ground-source loops was measured, where accessible.
- Some heat pump electricity meters included the energy used by the circulation pump on the central heating side as part of the measurement. This is because this pump is often included within the heat pump itself.
- Air-source heat pumps with defrost cycles had bi-directional heat meters on the total output from the heat pump. When undergoing defrost, most air-source heat pumps operate in reverse cycle mode; that is, they take heat from the heat sink (the house) and deliver it to the heat source (the evaporator). Thus, the net energy delivered to the heat sink is thus the heat output from the heat pump minus the heat supplied back to the heat pump during defrost.
- For sites that have a pump continuously bringing hot water to the taps, a heat meter was installed on the recycling loop for the hot water.
- For 11 sites, heat input to the domestic hot water cylinder was also measured; 18 sites provided space heating only.
- Sites where there was solar input into the domestic hot water cylinder are also being monitored as part of the Energy Saving Trust's solar thermal trial. In these cases, both the solar and heat pump inputs into the cylinder are monitored.

Full details of the monitoring equipment used are given in Appendix 1.

1.5. Heat Balances

Heat balances were not included in the original technical monitoring specification for the project, but were included at a small sample of properties at the request of the monitoring contractors (Gastec at CRE and EA Technology). While it would have been desirable to undertake more heat balances, this was not done due to on-site practicalities and project cost constraints. Nevertheless, the results of the heat balances at the nine sites where this was undertaken do raise confidence in the metering arrangements used throughout the trial.

Gastec at CRE first introduced the concept of energy balance validation within the Carbon Trust micro-CHP field trial project, and it has subsequently been used on many Carbon Trust and Energy Saving Trust field trials. The idea is to compare all of the energy inputs to the heat pump enclosure with all of the energy outputs over a 24-hour period. A close agreement between inputs and outputs raises confidence in the metering used. Energy inputs cover both the electricity input to drive the heat pump and the heat from the ground. Energy outputs cover both the measured heat

delivered by the heat pump and an estimate of the heat losses from the heat pump enclosure.

The monitoring of energy in air flows through air-source heat pump systems was attempted using anemometers, but this proved problematic. Thus, energy balance calculations have not been carried out for the air-source heat pumps in the trial.

2. System Boundaries in the Energy Saving Trust's Field Trials

The Energy Saving Trust's study comprised a number of different heat pump system configurations.

The original specification was designed to be compatible with Energy Saving Trust's condensing boiler field trials, and therefore **required measurement of the heat of the domestic hot water actually used**, rather than measurement of the heat supplied to the hot water cylinder.

Thus, the focus of the study was the "system efficiency", rather than the efficiency of the heat pump only. The definition of system efficiency is given below:

$$\text{System efficiency} = \frac{(H_{CH} + H_{DHW_{OUT}})}{(E_{HP} + E_{Auxiliary} + E_{Immersion} + E_{Circulation pumps})}$$

Where:

H_{CH} = heat supplied to central heating circuit

H_{DHW_OUT} = heat of hot water **used** (as opposed to heat supplied to the hot water cylinder)

E_{HP} = electricity supplied to heat pump

$E_{Auxiliary}$ = electricity supplied to supplementary heating cassette

$E_{Immersion}$ = electricity supplied to domestic hot water cylinder

$E_{circulation pumps}$ = electricity supplied to circulation pumps on the central heating side.

In 18 cases, the heat pump supplied space heating only.

In 11 cases, the heat supplied to the hot water cylinder was also monitored. In the second year of monitoring, additional heat meters will be inserted to measure the heat supplied to the hot water cylinder, wherever this is possible.

In some cases, the auxiliary heating cassette and/or the domestic hot water cylinder are integral to the heat pump. In these cases, the electricity supplied to the pump also includes the electricity supplied to the auxiliary cassette and/or immersion heater.

Four variants of monitoring systems are shown below:

- central heating only (Figure 2)
- central heating only, and separate measurement of auxiliary heating from the electric flow boiler ($E_{\text{Auxiliary}}$) (Figure 3)
- central heating + hot water – measuring both the input and output heat from the hot water (Figure 4)
- central heating + hot water; system with a domestic hot water cylinder included in the heat pump itself (Figure 5). The electricity used by the heat pump includes electricity used by the auxiliary electric flow boiler and the domestic hot water immersion.

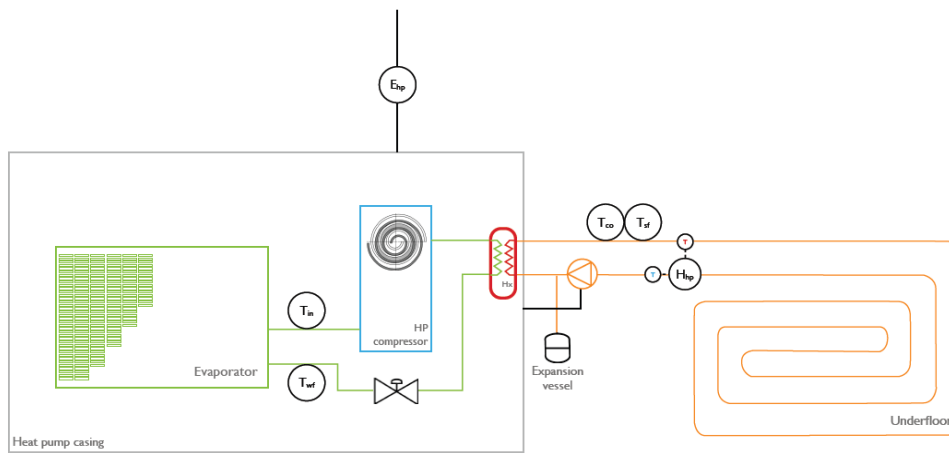
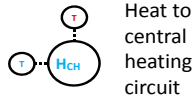
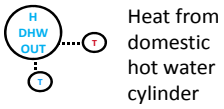
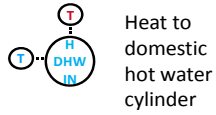

Figure 2: Simple system, measuring heat supplied to a central heating system only

Legend

Heat Meters



Electricity meters

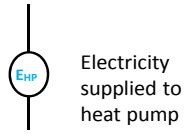
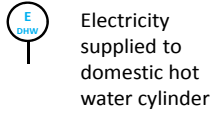

Temperature sensors

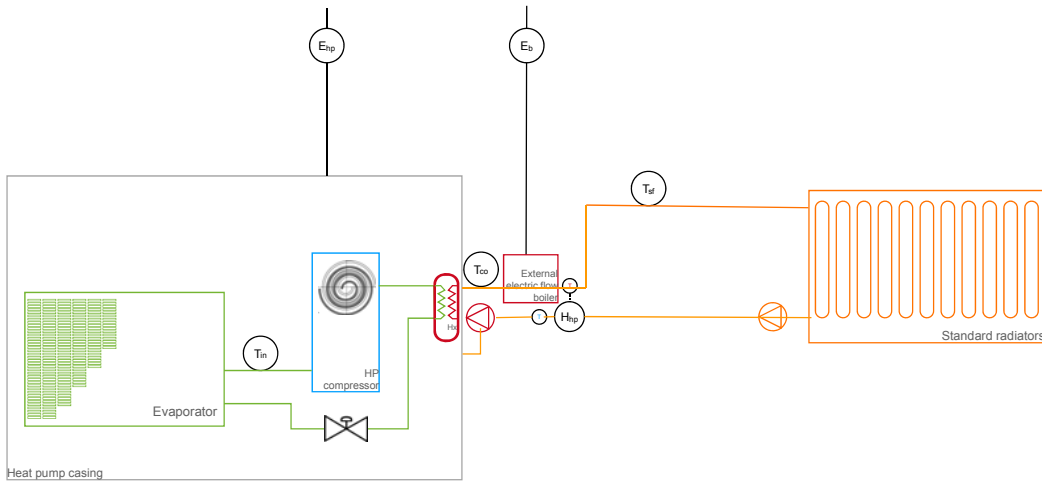
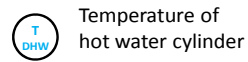
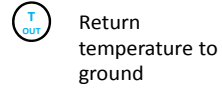
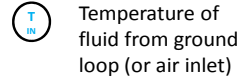

Figure 3: Simple system, with separate auxiliary electric flow boiler, supplying heat to a central heating system only

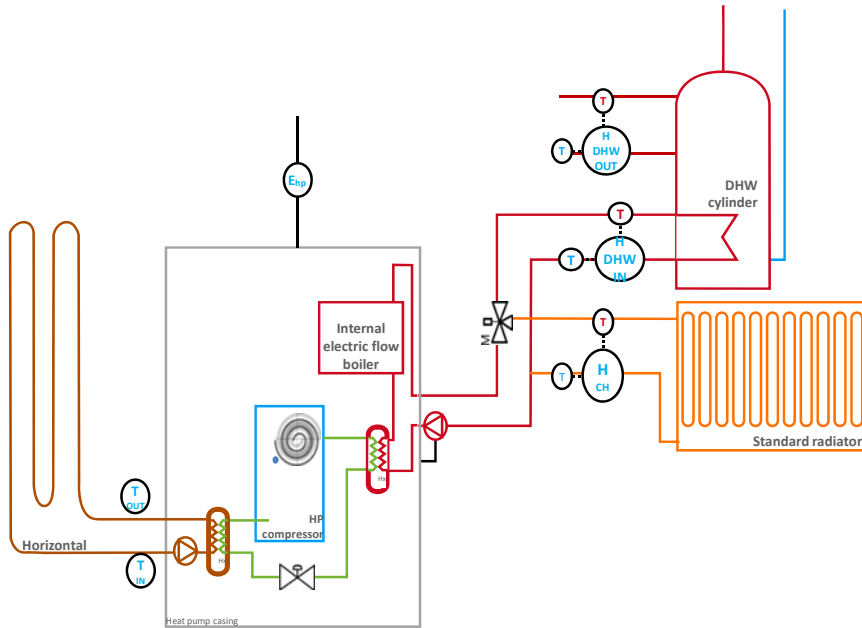

Figure 4: System supplying central heating and hot water.

In this example, the heat input and output to the domestic hot water cylinder are both measured. The electricity used by the hot water immersion is monitored separately from the electricity used by the heat pump. In this example, the auxiliary electric flow boiler is included in the heat pump itself; in some examples, it is possible to monitor the auxiliary electricity separately.

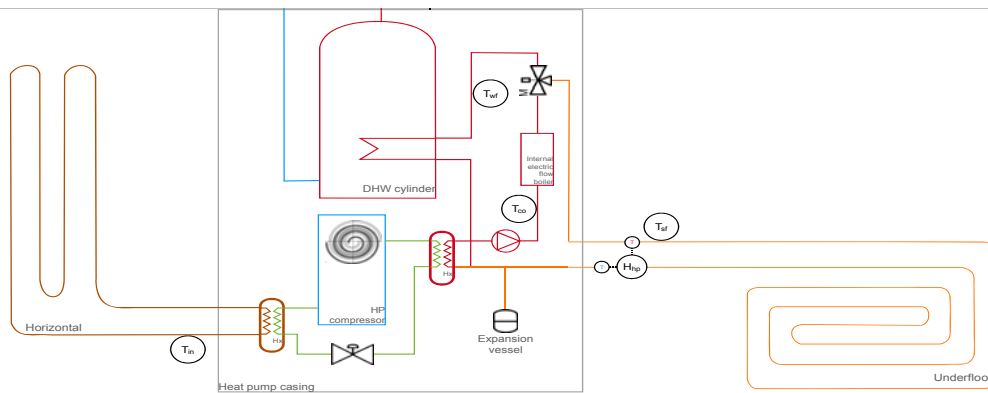

Figure 5: System supplying central heating and hot water.

The hot water cylinder is located inside the heat pump. The heat of the hot water used is monitored. The electricity supplied to the heat pump includes electricity for the auxiliary flow boiler, which may be used either for space or water heating.

3. Data Checking

The Energy Saving Trust's technical monitoring specification required the weekly download and checking of data from each site. This included checking the range and calculating system efficiencies, to confirm the consistency of the data.

The procedure for data checking is given in detail in Appendix 2.

4. Analysis

The starting point for all analysis is the quality controlled 5-minute data of heat flows, electricity usage and a range of temperatures (ambient, indoor, flow and return to ground, flow and return from central heating and hot water cylinder temperatures).

The analysis reported in this document has been carried out by DECC and by the Energy Saving Trust's contractors, Gastec at CRE, EA Technology and the Energy Monitoring Company. It falls into three categories:

- histograms of system efficiency for all heat pumps in the trial, grouped by ground and air source, and by heating system (Section 6)
- analysis of individual sites, using histograms of monthly system efficiency and scatterplots of source and sink temperatures (Section 7)
- high-resolution time series of data (Section 7).

High-resolution time series of data have been used to identify particular characteristics, e.g. ground loop flow and return temperatures on cold winter days, or pasteurisation cycles for hot water cylinders.

A suite of MATLAB functions was written to smooth the 5-minute data to 20-minute periods, and to extract any periods during which the heat pump switched on or off.

A number of complex charts are presented in the following sections. Each time a new chart appears, an explanation of the analysis is given in a text box.

5. Additional Analysis of Distributions of System Efficiencies for Ground- and Air-source Heat Pumps

This section is based on the additional analysis of data from Phase I of the Energy Saving Trust's heat pump field trial. There are four reasons for the changes:

- the estimated and calculated efficiencies have been revised
- the data supplied by one of the manufacturers (referred to as 'Manufacturer A' in this report) have been reanalysed, in order to present the system efficiency using estimated cylinder losses
- sites with input from solar thermal systems⁶ have been analysed
- the estimated system efficiency for the site which operates in conjunction with an oil boiler has been revised.

5.1. Revision of Estimated and Calculated Efficiencies

The additional analysis that has been conducted resulted in the revision of system efficiency figures for some heat pumps in the EST's heat pump field trial. These are summarised below:

5.1.1. Air-source Heat Pumps

- In *Getting warmer*, data from a number of air source heat pumps were provided by a manufacturer (Manufacturer A). Since these data were not collected by the Energy Saving Trust's team, the results from such installations were depicted as lightly shaded bars in the graph in *Getting warmer, page 15*. The solid shading of one bar suggests that there was a non-Manufacturer A air-source heat pump with a measured system efficiency of 3; this should have been depicted as a Manufacturer A system.
- Site 478 – The original calculation of system efficiency was 2.48, the highest for all the air-source heat pumps monitored in the trial except for the Manufacturer A sites.⁷ The heat pump was working on the internal electric cassette only for the first month, but the calculation of system efficiency did not include any contribution from this source at any stage

⁶ These sites were not included in the analysis presented in the Energy Saving Trust Report *Getting warmer: a field trial of heat pumps*, as discussed in Section 5.3.

⁷ These sites were found to have a higher estimated system efficiency; see Section 5.2.

throughout the year. The corrected estimate of system efficiency is based on the measurements excluding the first month and is substantially lower, at 1.85.

- Site 479 – Electricity used by the internal heating electric cassette was omitted in the calculation of system efficiency. As a result, the system efficiency has been reduced from 2.32 to 2.07.

5.1.2. Ground-source Heat Pumps

- A single heat pump supplies heat to houses 427 and 428. In the original calculation of system efficiency (1.92), only the heat to house 427 was included. The revised estimate is 2.66.
- Similarly, a single heat pump supplies houses 450 and 468. The original calculation of system efficiency was 1.27; the revised estimate is 1.66.
- Three sites (463, 476 and 482) have been removed from this subsequent analysis because of unreliable data from heat meters. The original calculations of system efficiency were 3.18, 1.43 and 3.03 respectively.

5.2. Reanalysis of Air-Source Heat Pump Data Supplied by 'Manufacturer A'

Manufacturer A supplied data from seven air-source heat pumps, which were monitored separately by the company. These heat pumps provided domestic hot water and space heating using over-sized radiators.

Data supplied to the Energy Saving Trust were audited by its contractors. The monitoring specification differed from the Energy Saving Trust's field trial's specification in the following ways:

- electricity use by the hot water immersion was not measured
- electricity use by the supplementary electric cassette was not measured (although, for the site inspected, these were not used)
- electricity usage by circulation pumps was not measured
- although the heat input to the domestic hot water tank was measured, the heat in the domestic hot water actually used was not.

For these reasons, the estimated system efficiencies of these sites were represented by shading in the graphs presented in *Getting warmer* (page 15).

It is important to note that the Manufacturer A heat pumps used glycol, rather than water, in the central heating system. Consequently, for this report, the heat flow data have been adjusted to take account of the lower specific heat capacity of glycol.

Equally importantly, these systems, unlike the others in the trial, were not selected randomly. Some of the heat pumps were installed in the houses of members of staff. In some, but not all, cases, the controls were carefully adjusted and changed as a result of the monitoring for research purposes. In particular these systems use very closely optimised external compensation of the radiator flow temperature and oversized radiators. The effect of this is to give high coefficients of performance (COPs) and system efficiencies during spring and autumn. The result of this is that the COPs on the coldest days (which must define installed power station and distribution infrastructure in the future) are fairly typical of good air-source heat pumps. **Not all of the sites monitored by Manufacturer A were fine tuned in this way: in some cases, the controls were simply set up to the manufacturer's recommendations (after the system had been designed and installed to company recommendations).**

The data from Manufacturer A are a very useful addition to this trial, and demonstrate that high performance can be achieved by air-source heat pumps. Nonetheless, since the site selection was not random and the monitoring was not carried out to the same specification as the remainder of the sites, **it is appropriate to display these data on separate charts, see Figure 6.**

The field trial does not contain similarly optimised ground-source heat pumps.

5.3. Analysis of Sites with Solar Thermal Inputs

Sites with solar thermal inputs were not included in *Getting warmer* since, at the time, no information on the solar input was available. The data are now available so they have been included in this report.

There is one site in the trial in which the ground-source heat pump supplies heat to central heating only, and domestic hot water is provided by a solar thermal system (site 492). The system efficiency (3.37) is based only on the heat supplied by the heat pump to the central heating.

A further five sites have combined heat pump and solar thermal systems (sites 451, 452, 471, 473 and 491). For these sites, the system efficiency can be calculated in two ways:

- treating the solar energy as a 'free' input
- excluding the solar energy.

In the analysis presented here, the contribution from the solar thermal system has been removed from the estimate of the system efficiency.

For each of the five combined heat pump and solar thermal sites, we can calculate the overall efficiency of the hot water cylinder (as we have measurements of all heat inputs and outputs to and from the cylinder⁸). These figures can be used to calculate the proportion of solar heat which is useful (i.e. not lost through the cylinder walls or pipes).

Estimates of system efficiency can be made only for those periods for which data from all instruments are available (i.e. periods for which no solar thermal inputs are available must be excluded). Overall, the effect of these changes is to reduce system efficiency by 0.1.

5.4. Revised Analysis of the Site with an Oil Boiler (454)

One system (site 454) includes an oil boiler, which provides heat for space heating only. The heat pump supplies heat to both the central heating and the domestic hot water cylinder.

In *Getting warmer*, the system efficiency was calculated **including** the contribution from the oil boiler. In this report, however, we wish to present the system efficiency of the heat pump only. This is calculated as follows:

$$\text{System efficiency} = \frac{(H_{CH_HP} + H_{DHW_OUT})}{(E_{HP} + E_{Auxiliary} + E_{Immersion} + E_{Circulation pumps})}$$

H_{CH_HP} = heat supplied to the space heating circuit by the heat pump (measured after the circulation pumps)

H_{DHW_OUT} = heat in the domestic hot water that is extracted from the cylinder. Note that the oil boiler contributes to the central heating only

E_{HP} = electricity used by the heat pump

⁸ Heat flow data from the solar thermal panels to the hot water cylinder are now available, which was not the case when *Getting warmer* was published.

$E_{Immersion}$ = electric immersion to the hot water cylinder

$E_{Auxiliary}$ = electricity used by the internal electric cassette

$E_{Circulation\ pumps}$ = electricity used by the circulation pumps.

The heat from the oil boiler (H_{Oil_Boiler}) supplies the central heating circuit only. It is deducted from the total heat supplied to the space heating circuit to find H_{CH_HP} as follows:

$$H_{CH_HP} = H_{CH} - H_{Oil_Boiler}$$

H_{CH} = the total heat input to the space heating circuit (measured after the circulation pumps)

The net effect is to **raise** the system efficiency to 2.53.

It should be noted that this correction for heat provided by the oil boiler does not totally eliminate the influence of the boiler; the space heating return will carry residual heat from the oil boiler, which will affect the heat pump performance.

5.5. Revised Histograms of System Efficiency of Air- and Ground-source Heat Pumps

Figure 6 shows the system efficiencies of air- and ground-source heat pumps. The estimated system efficiencies supplied by 'Manufacturer A' for its air-source heat pumps are shown separately, for the reasons explained in Section 5.2. There is a clear difference in the distributions, the average efficiencies being 1.82 for the air-source heat pumps and 2.39 for the ground-source heat pumps. Table 1 shows the statistics.

System efficiency		Ground source
Number	22	49
Mean	1.82	2.39
Standard deviation	0.28	0.45
Standard error on estimate of mean	0.06	0.06
Median	1.83	2.31
Mode	1.6	2.2

(most common value)		
Range	1.2–2.2	1.55–3.37

Table 1: Statistics on the system efficiencies of air- and ground-source heat pumps in the field trial

The mean system efficiency of the six air-source heat pump sites for which data were supplied by Manufacturer A was 2.75.⁹ However, it should be remembered that there were no comparable data supplied by manufacturers for ground-source heat pumps.

⁹ There were seven sites provided by Manufacturer A, but site 203 had only two months of data, June and July 2009, and so has been omitted from the report.

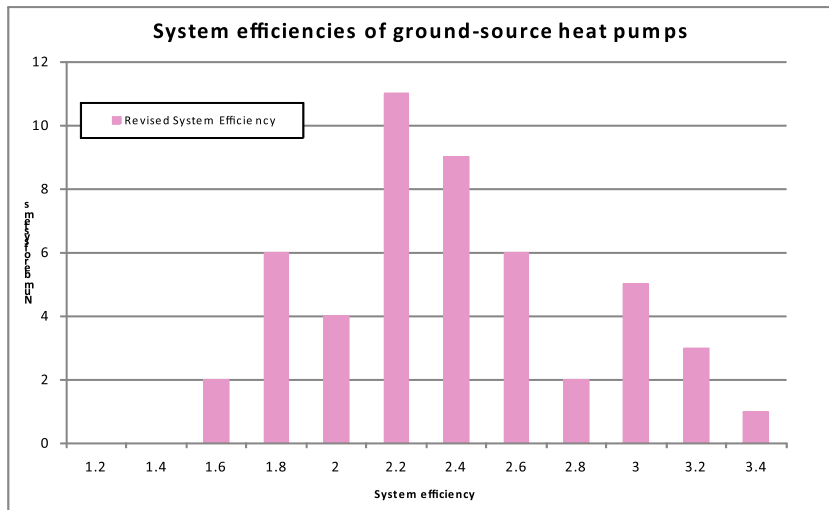
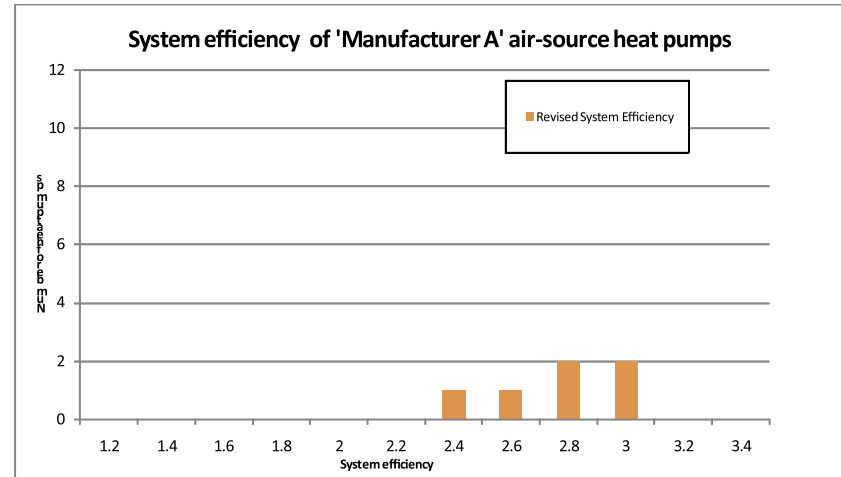
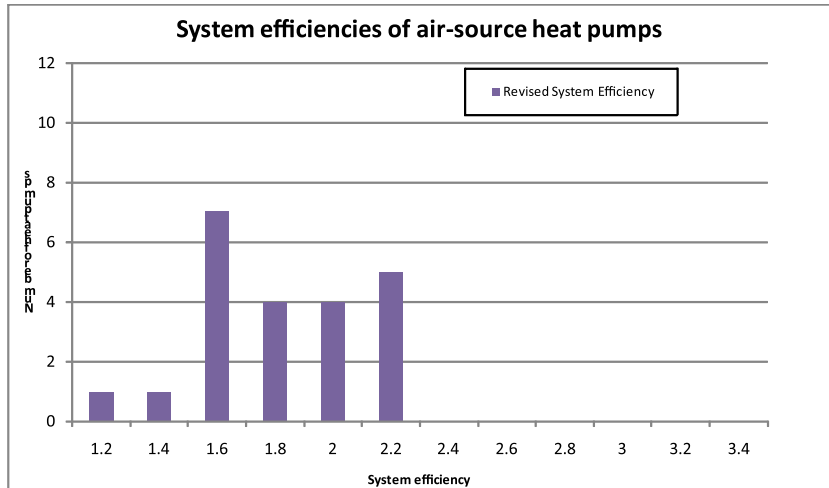

No equivalent optimised data available for ground-source heat pumps in the first phase of the trial. Note that the system efficiencies for the Manufacturer A heat pumps are estimated.

Figure 6: Summary of the revised estimates of system efficiency for the first year of the heat pump field trials

6. Analysis of System Efficiency as a Function of Emitter Type and Domestic Hot Water Production

Additional analysis has been undertaken to investigate system efficiency as a function of emitter type and hot water production. This analysis was not presented in the Energy Saving Trust's *Getting warmer* report.

6.1. Ground-source Heat Pumps

Figure 7 and Table 2 show system efficiency of ground-source heat pumps as a function of emitter type (either largely under-floor, which includes systems with under-floor heating only, under-floor heating and domestic hot water, and under-floor heating and radiators; or largely radiators, which includes systems with radiators only and systems with radiators that also provide hot water). There is a clear trend, with under-floor systems having higher system efficiencies than radiator systems (the medians are 2.51 and 2.21 respectively). It should be remembered that some under-floor systems use high temperature flows; these would be expected to have poorer performance. Conversely, some radiator systems use very low temperature flows. A more thorough analysis would plot the system efficiency against the central heating flow temperature. This analysis will be carried out in the second year report.

Figure 7 and Table 3 show system efficiency of ground-source heat pumps divided into systems that provide hot water and those that do not. Comparison is difficult, as only seven systems do not produce hot water, but it appears that these systems have a higher average performance, as expected. More data are required.

	Largely radiator heating	Largely under-floor heating
<i>Number</i>	27	22
<i>Average</i>	2.23	2.58
<i>Standard deviation</i>	0.33	0.50
<i>Standard error on estimate of mean</i>	0.06	0.11
<i>Median</i>	2.21	2.51
<i>Mode</i>	2.2	2.4
<i>Range</i>	1.8–3.0	1.6–3.4

Table 2: Revised system efficiency of ground-source heat pumps as a function of heating type

	With hot water production	Without hot water production
<i>Number</i>	42	7
Average	2.34	2.68
Standard deviation	0.42	Sample size too small
Standard error on estimate of mean	0.07	Sample size too small
Median	2.29	2.71
Mode	2.4	3.0
Range	1.6–3.4	1.8–3.4

Table 3: Revised system efficiency of ground-source heat pumps as a function of hot water production

This analysis is necessarily simplistic as it is based on the assumption that under-floor heating systems have lower average flow temperatures than radiator systems; in practice, mixed systems may have relatively high flow temperatures. A more detailed analysis would plot system efficiency as a function of central heating temperature.

6.2. Air-source Heat Pumps

Figure 7 and Table 4 show the system efficiency of air-source heat pumps as a function of emitter type.

There is no apparent trend in the air-source heat pump data. Since there are only 17 systems with radiators and five with under-floor heating, it is not possible to determine reliable statistics for the system performance. In particular, the sample size is too small to allow a reliable calculation of the standard error.

Figure 7 also shows the system efficiency of air-source heat pumps divided into systems that provide hot water and those that do not. The data are also shown in Table 5. Again, no trend is detected.

	Largely radiator heating	Largely under-floor heating
<i>Number</i>	17	5
Average	1.82	1.86
Standard deviation	Sample size too small	
Standard error on estimate of mean	Sample size too small	
Median	1.81	1.85
Mode	1.6	1.6
Range	1.2–2.2	1.4–2.2

Table 4: Revised system efficiency of air-source heat pumps as a function of heating type

	With hot water production	Without hot water production
<i>Number</i>	13	9
Average	1.83	1.83
Standard deviation	Sample size too small	
Standard error on estimate of mean	Sample size too small	
Median	1.81	1.87
Mode	1.6	1.8
Range	1.4–2.2	1.2–2.2

Table 5: Revised system efficiency of air source heat pumps as a function of hot water production

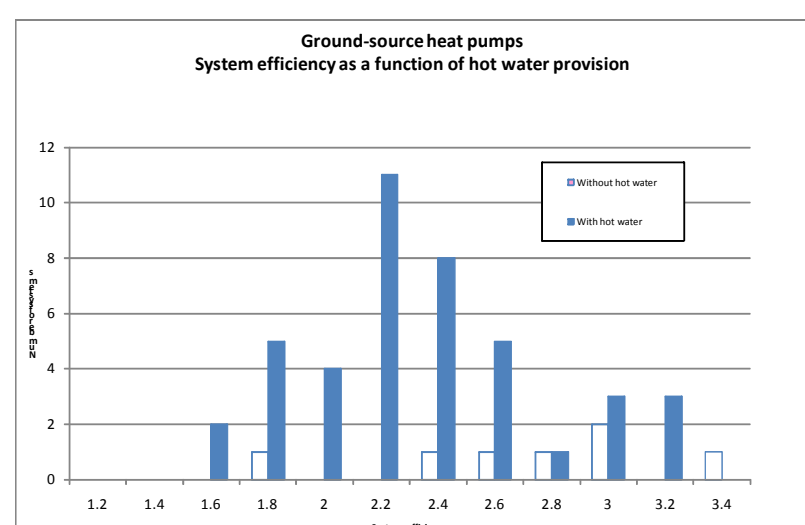
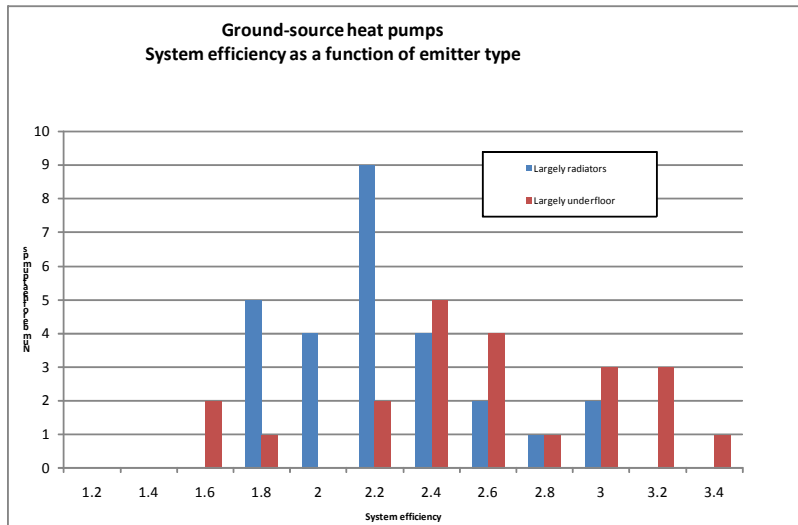
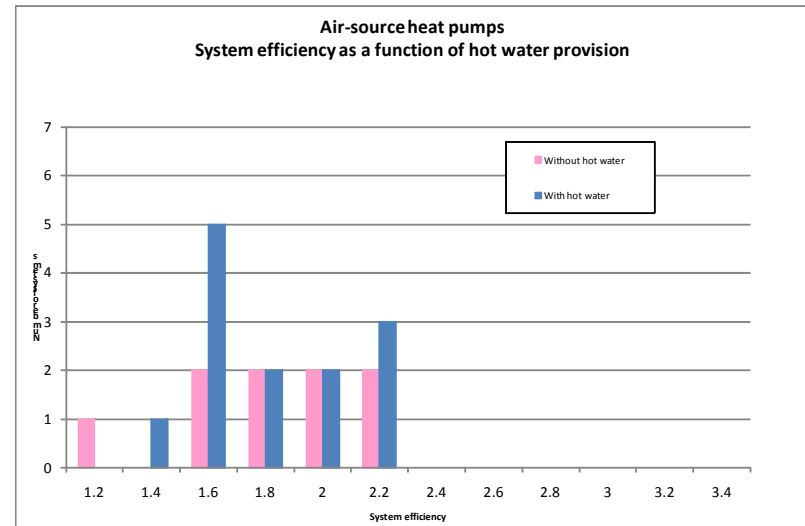
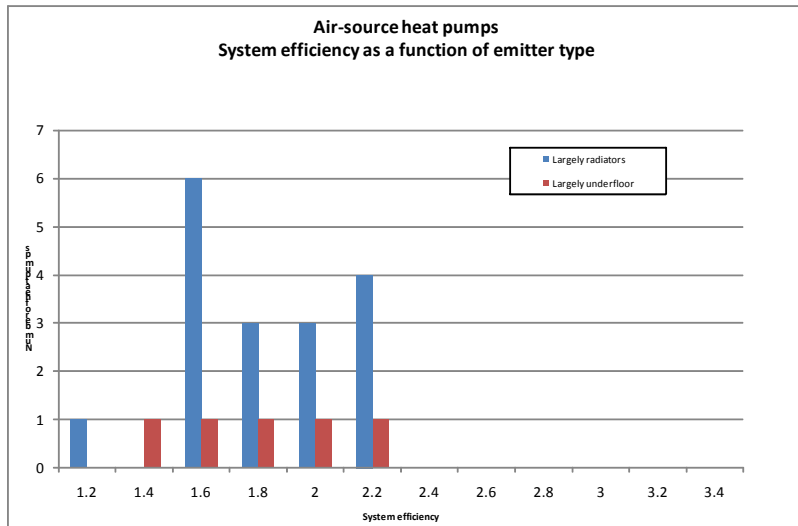

Figure 7: System efficiency of ground- and air-source heat pumps as a function of emitter type and hot water production

7. Examples of Good Performance

This section shows some examples of sites which the overall system efficiency was considered to be high.

7.1. Ground-source Heat Pump Supplying Under-floor Heating Only, Site 430

This 8kW ground-source system extracts heat from two 40m horizontal loops and supplies under-floor heating for a large converted barn. A wood-burning stove is available for supplementary heating of the living room.

The dwelling is relatively well insulated, with a SAP rating of 76 points (Band C). It is located in Cumbria.

From Figure 8, we observe that the heat pump has been sized to allow operation on an Economy 10 tariff (10 hours of cheap electricity per day, from midnight to 5am, from 1pm to 4pm and from 8pm to 10pm – avoiding periods of peak demand). Sizing heat pumps in this manner could have benefits for the grid.

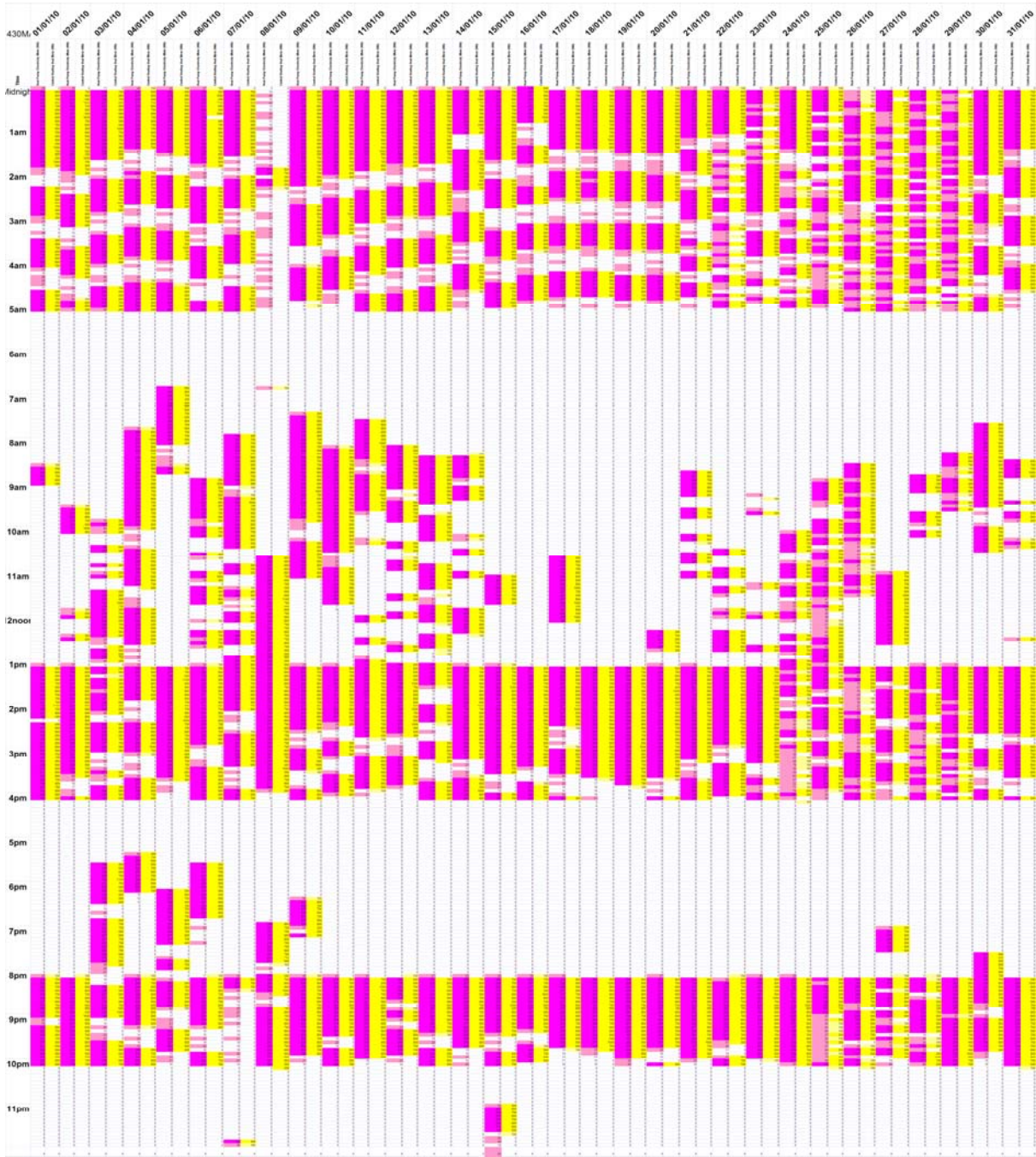

Figure 8: Daily heating pattern for a ground-source heat pump using Economy 10 heating (site 430)

Explanation of figure: The tapestry chart above represents one calendar month. Each vertical line shows a single day, with the hours of the day down the left-hand side. Pink shading indicates that the system is using electricity, while yellow shading shows that heat is being produced. This system has predominantly been used on an Economy 10 tariff, with 5 hours of heating at night, 3 hours in the afternoon and 2 in the evening, although there is also evidence that the heat pump was used outside these hours on cold days.

The flow temperature of the under-floor heating system was 35°C, which was sufficient to provide a good degree of comfort throughout the measurement period (around 23°C downstairs and 20°C upstairs on a typical winter's day). The minimum ground return temperature recorded was 1°C, indicating that the ground loops were appropriately sized and installed.

The overall system efficiency was found to be 2.98, as shown in the monthly histograms below.

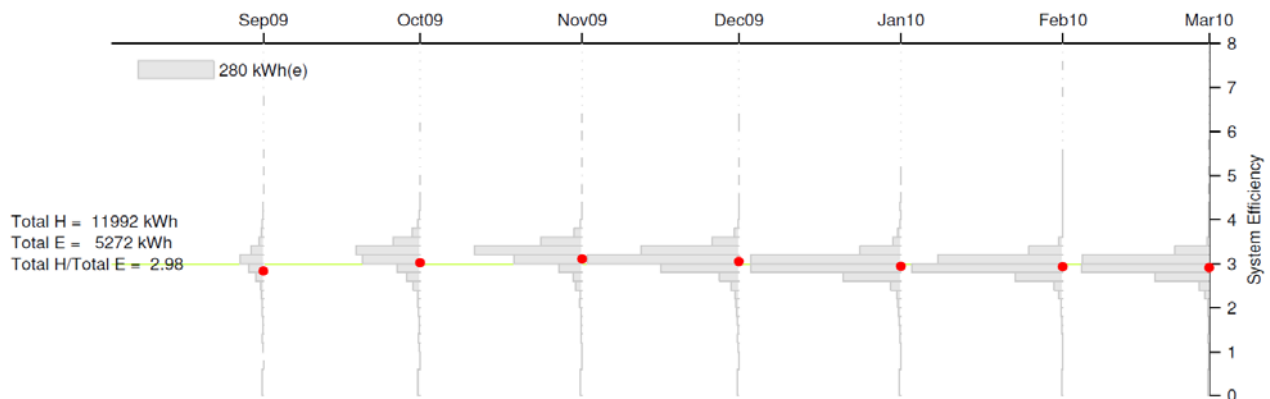

Figure 9: Monthly distribution of system efficiencies for a ground-source heat pump supplying under-floor heating only (site 430)

Explanation of figure: The monthly system efficiency is plotted as red dots in this figure. Underneath, the figure shows distributions of the electrical energy consumed in bins of smoothed, 'instantaneous' system efficiency. The instantaneous system efficiency is smoothed in this case by using an average of 20-minute operating periods. An area in the top left of the figure shows the relationship between area and electrical energy consumption. Generally, less electrical energy is consumed in the summer, which is why the bar areas are smaller through those months. The green line is the yearly system efficiency.

Further improvements may be possible on this site, as it has a high circulation pump load (250W).

7.2. Ground-source Heat Pump Supplying Under-floor Heating Only, and Hot Water, Site 439

Site 439 is a house located in Cheshire. It is also a barn conversion, but is slightly less well insulated than the first example, with a SAP rating of 69 points (Band C). An 11kW heat pump extracts heat from three 50m horizontal loops and supplies heat to an under-floor heating system and to a domestic hot water cylinder within the heat pump. There is also a wood-burning stove.

The configuration is shown below.

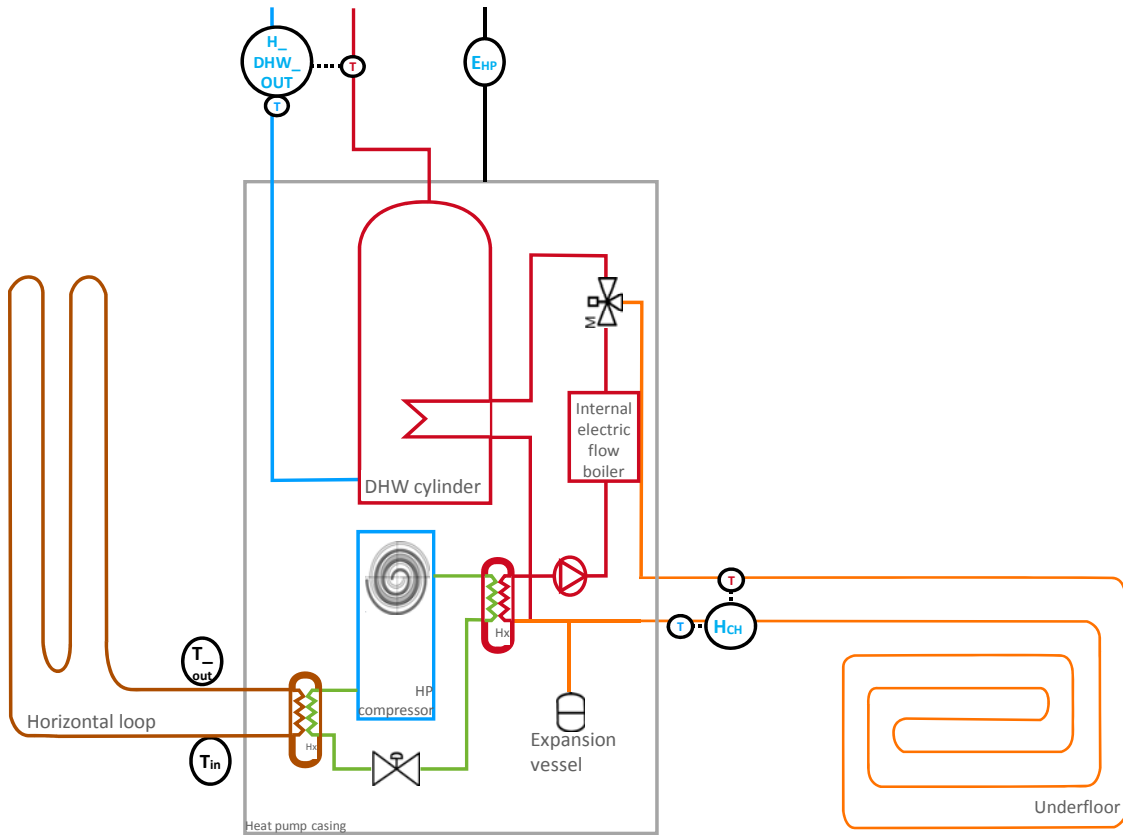

Figure 10: Configuration for site 439 (ground source heat pump supplying under-floor heating and domestic hot water)

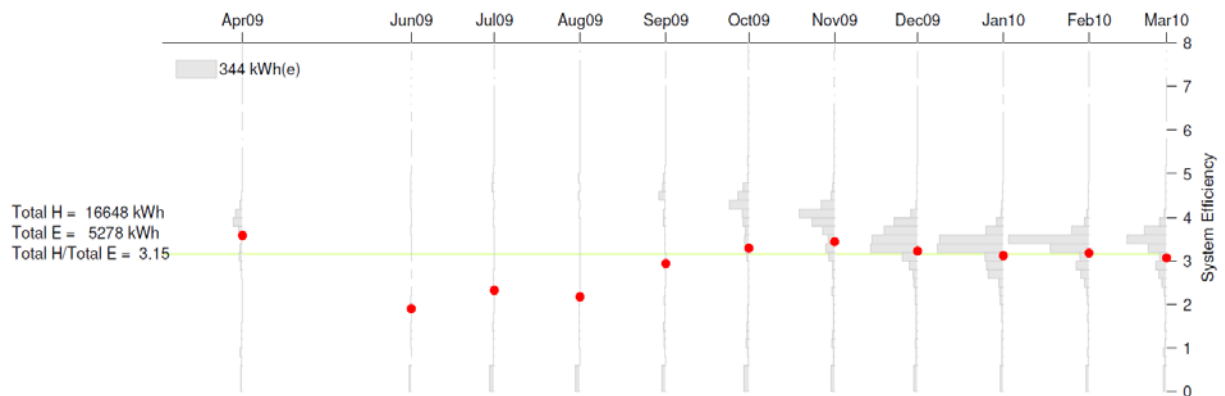

Figure 11: Monthly distribution of system efficiencies for a ground-source heat pump supplying under-floor heating and domestic hot water (site 439)

The system used weather compensation. On a cold winter's day (ambient -4.9°C), the central heating flow temperature was averaging about 35°C . This temperature reduces to an average of approximately 32°C on a milder day (ambient 4.7°C).

The circulation pump power is considerably lower than in the previous example (70W). The overall seasonal performance factor was found to be 3.42, which is indicative of very good performance.

During the summer months, the system efficiency is dominated by hot water production. The system efficiency falls to just over 2, which is one of the highest efficiencies recorded for hot water production in the trial. This figure takes account of losses from the hot water cylinder.

The scatterplot below shows the heat output in kW as a function of return temperature of the ground loop ('entry water temperature'). On the coldest day, the return temperature from the ground was between 0°C and 2°C , and the seasonal performance factor was still 3.17. This indicates a correctly sized ground loop.

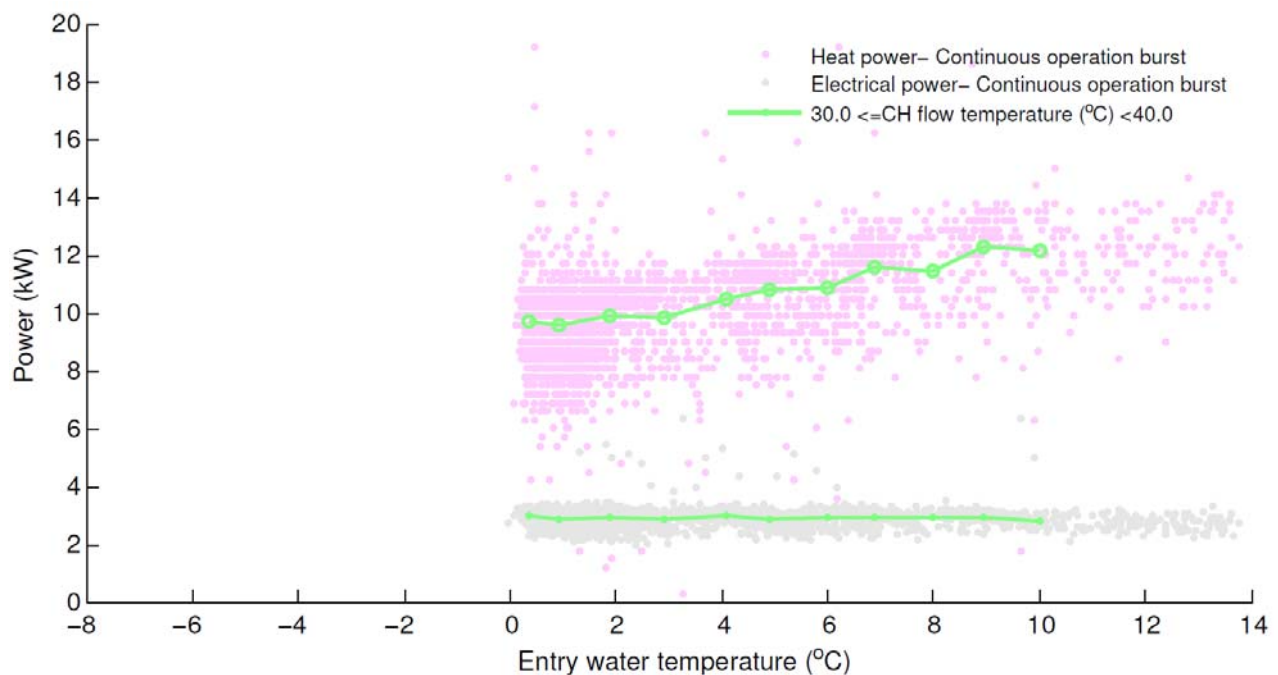

Figure 12: Scatterplot of heat and electrical power as a function of heat pump entry water temperature for a ground-source heat pump supplying under-floor heating and domestic hot water (site 439)

Explanation of figure: The figure shows the heat pump electricity consumption and heat power delivered for 20-minute operating bursts delivering central heating continuously. All other data bursts are removed, including bursts during which the heat pump turns on or off. Where the heat pump has operated over a wide enough range of central heating flow temperatures, higher temperatures are plotted as warmer colours.

The system provided domestic hot water at an average temperature of 38°C, with a weekly sterilisation cycle to control growth of bacteria including *Legionella*.

7.3. Ground-source Heat Pump Supplying Radiators, Site 419

Site 419 is a detached house located in Aberdeenshire. It is of solid wall construction, with a more modern extension; overall, the SAP rating is lower than the UK average, at 50 points (Band E). A 12kW ground-source heat pump that extracts heat from two boreholes (of 90m and 60m respectively) and supplies radiators and domestic hot water. The heat pump is used 24 hours a day during the winter months. During the winter, the central heating flow temperature was found to be around 47°C. The total area of radiators is sufficient to supply background heating, which is supplemented by the use of a wood-burning stove in the living room. When the wood-burning stove is in use, downstairs temperatures reach up to 23°C; when it is not, downstairs temperatures range from 14°C to 18°C. Hot water usage is only 287kWh/year¹⁰ at this site, which is particularly low.

The overall system efficiency is 3.04, indicating good performance.

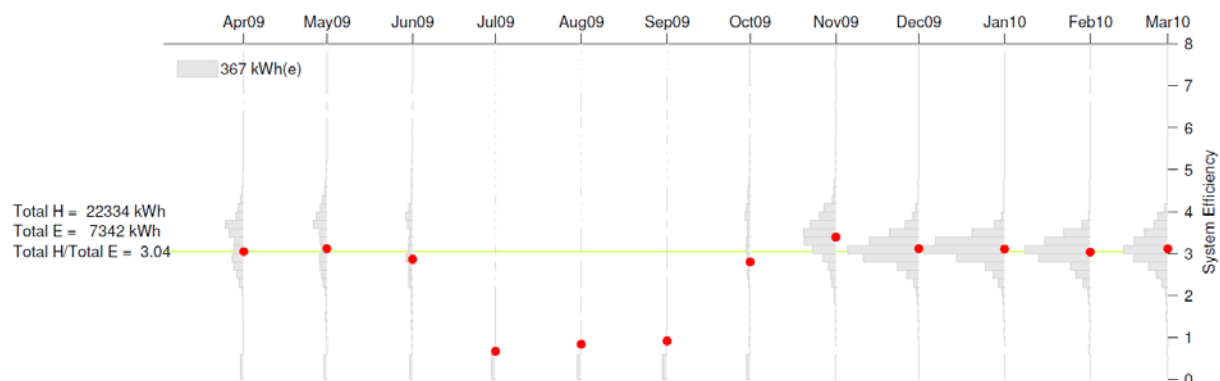

Figure 13: Monthly distribution of system efficiencies for a ground source heat pump supplying radiators (site 419)

7.4. Air-source Heat Pump Supplying Radiators, Site 443

Site 443 is a semi-detached bungalow located in Cheshire, with a SAP rating of 43 (Band E). It is heated by an 8kW air source heat pump that supplies heat to radiators. The heat pump is

¹⁰ As for all the sites with domestic hot water in this trial, this figure refers to the heat in the hot water actually used, not the heat supplied to the hot water cylinder.

controlled with a timer and provides a downstairs temperature of between 16°C and 20°C in January.

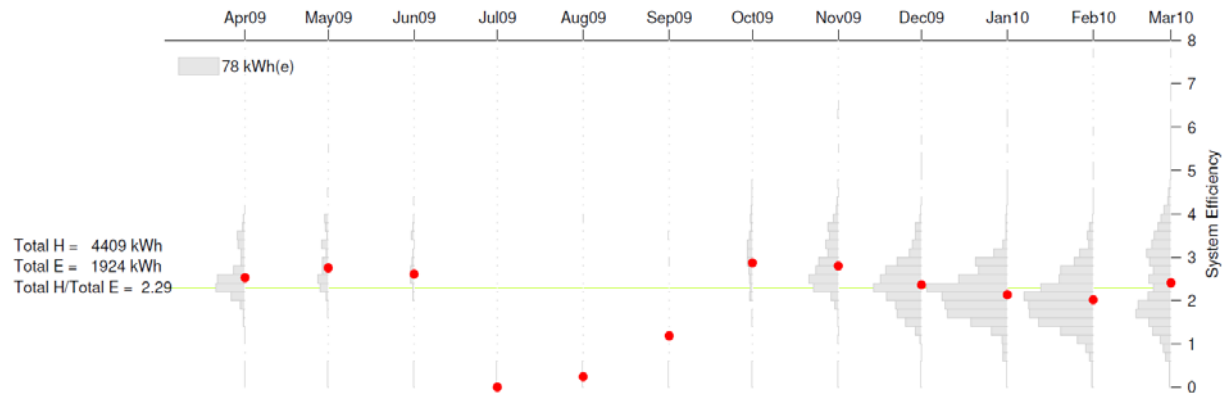

Figure 14: Monthly distribution of system efficiencies for an air-source heat pump supplying radiators (site 443)

The overall system efficiency was found to be 2.29, which is above average for the air source heat pumps in the field trial.

Initially, the system was set up to operate for 7 hours per day. In March 2010, the controls were changed to allow lower average central heating flow temperature through weather compensation,¹¹ and the timer was set to 24-hour operation.

The compressor map below is a scatterplot of the central heating flow temperature as a function of the evaporator air off temperature. The relatively straight line of data points between 40°C and 50°C represents the period before the controls were changed, and points between 30°C and 40°C represent the periods afterwards. Data points are colour coded to refer to the system efficiency; warmer colours indicate higher system efficiency. It can be seen that reasonably good system efficiencies (>=2.1) are obtained even at evaporator temperatures as low as 0°C.

¹¹ 'Weather compensation' means that the temperature of the water in the central heating circuit is varied according to the ambient temperature. On a relatively warm day, the temperature in the central heating circuit will be lower, and efficiency will be improved.

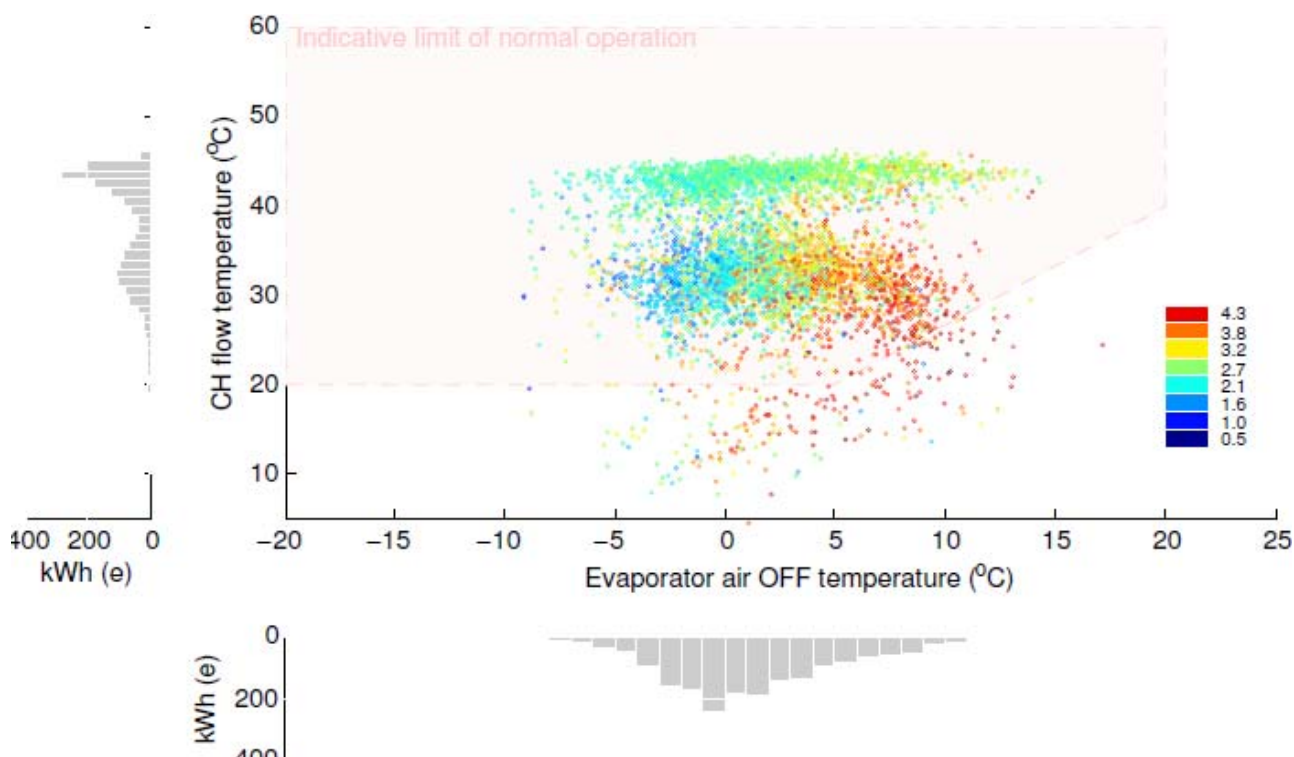

Figure 15: Scatterplot of central heating temperature against evaporator air off temperature (site 443)

Explanation of figure: In this figure, the heat pump evaporator air off and central heating temperatures are estimated for 20-minute bursts where central heating is produced using the flow and return temperatures as indicated in the figure. The data points are coloured according to the system efficiency of each burst. Energy-weighted histograms are plotted to show the density of the data points.

7.5. Low Cycling, Site 460

Many of the heat pumps in the trial cycle quite rapidly (four to six cycles per hour or more). Provided that the cycling is kept within limits, this does not appear to have a significantly adverse effect on performance (as is demonstrated by the EA Technology report on laboratory tests of the behaviour of heat pumps when used with thermostatic radiator valves¹²). Nonetheless, it seems reasonable to assume that excessive cycling over a prolonged period of time could cause damage to the compressor.

Site 460 is a semi-detached bungalow located in Cornwall, with a SAP rating of 49 (Band E). A 3.5kW ground source heat pump extracts heat from a borehole and supplies it to radiators and a domestic hot water cylinder.

¹² EA Technology 'The effect of thermostatic radiator valves on heat pump performance' June 2011
<http://www.decc.gov.uk/assets/decc/11/meeting-energy-demand/microgeneration/3531-effect-radiator-valves-heat-pump-perf.pdf>

The chart below shows good system efficiency when the heat pump is supplying the radiators (around 3), but poor system efficiency for hot water use, which drags the annual seasonal performance factor down.

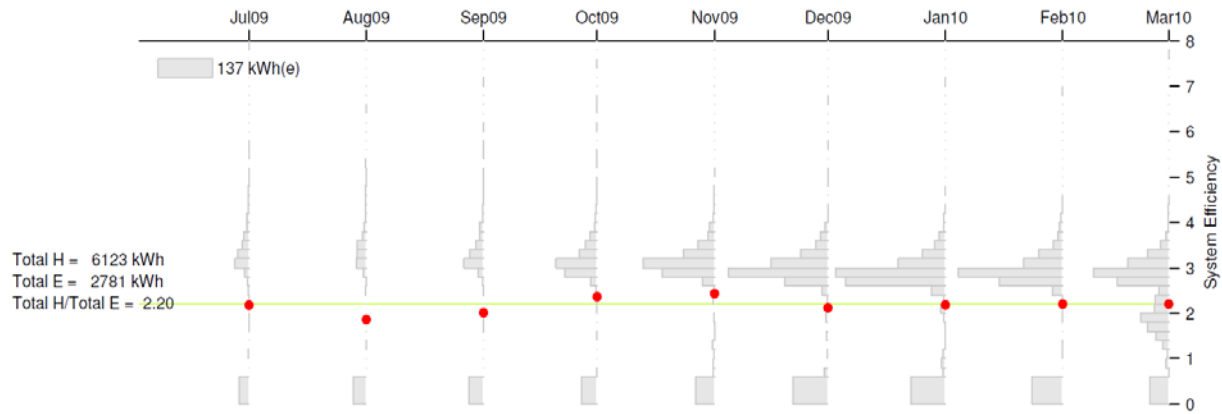

Figure 16: Monthly distribution of system efficiencies for a ground source heat pump supplying over-sized radiators (site 460)

Figure 17, below, shows the heat pump flow and return temperatures during three winter days when the outdoor temperature was fairly constant at around 0°C. Unlike many systems, the system does not cycle. Figure 18 shows electricity demand, which is fairly steady at around 1kW, except during a short period at night when the system is off. Note also that the heating control schedule shows a flow temperature of around 35°C during the day and 45–50°C for around 4 hours at night when the system is heating hot water.

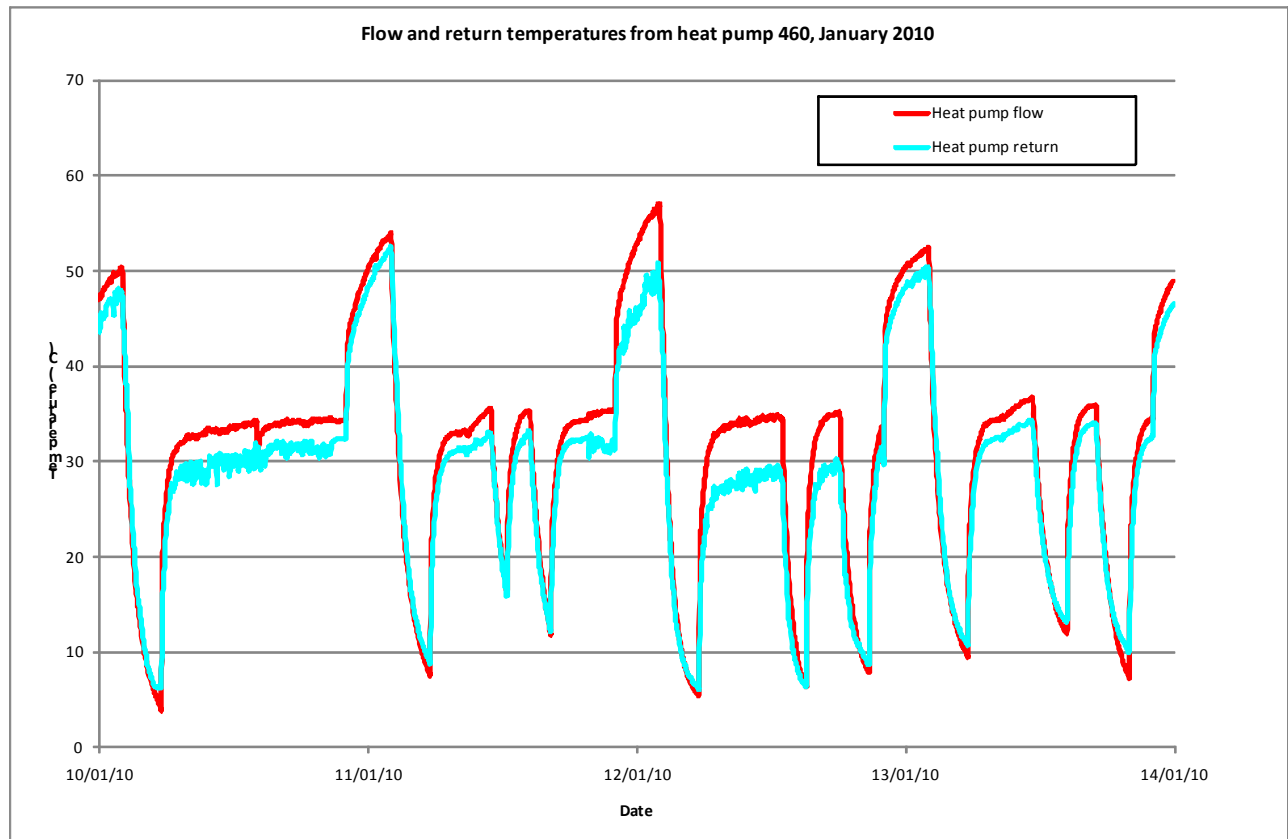

Figure 17: Central heating temperatures for a site with minimal cycling (site 460)

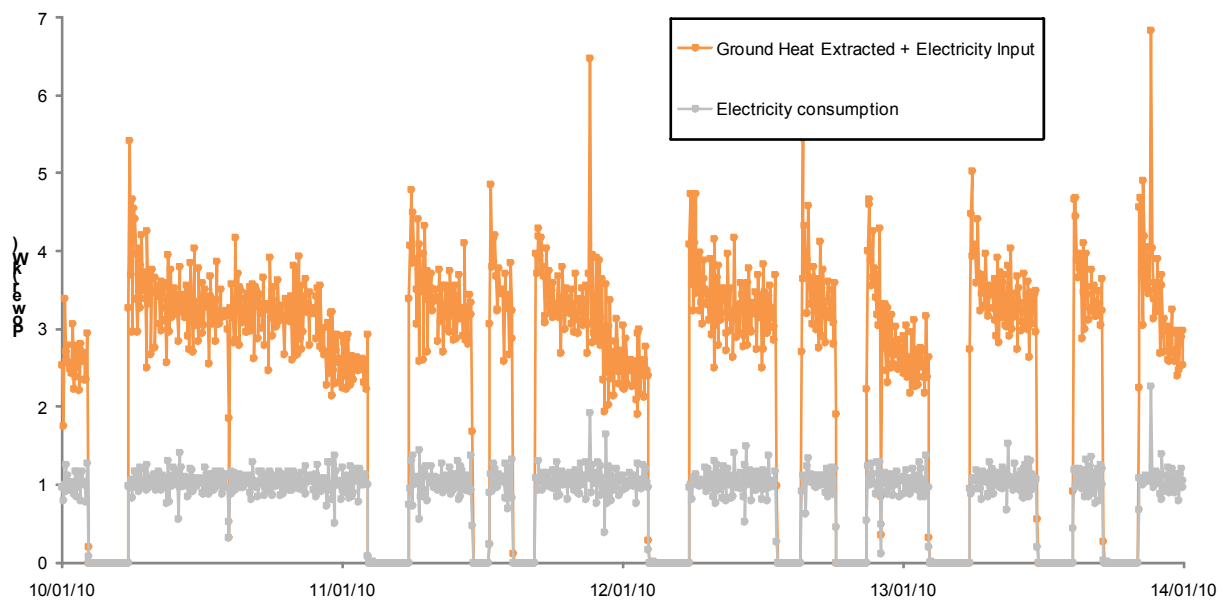

Figure 18: Electricity usage and ground heat extracted for a site with minimal cycling (site 460)

Cycling has been avoided by using high-volume, low-temperature radiators, so that the load is carefully matched to the capacity of the heat pump. This obviates the need for a buffer cylinder.

This site is also controlled with a conventional thermostat and timer.

8. Case Studies Relating to Under-performance

A number of factors have been found to contribute to under-performance. Approximate calculations have been performed using the results from the trial to establish their relative importance from the perspective of impact on system efficiency but not frequency of occurrence. Table 6 shows the factors divided into two categories: design and installation or commissioning.

Category	Factor	Estimated potential loss of performance as measured by system efficiency
Design	Under-sizing of heat pump	Up to 1.5
	Under-sizing of borehole/ground loop	Up to 0.7
	Insufficient insulation of pipework and hot water cylinders	0.3–0.6
	Under-sizing of hot water cylinder	Up to 0.4
	Too many circulation pumps	0.1–0.3
	Over-sizing/control strategy results in over-use of back-up heating	<0.1
Installation/commissioning	Central heating flow temperature too high: radiators	0.2–0.4
	Central heating flow temperature too high: under-floor heating	
	Circulation pumps always on	0.1–0.3

Table 6: Factors influencing performance

Other issues that were observed, but not detected from the monitoring data, were:

- loss of refrigerant – one site
- brine leakage – one site.

The test cases have been grouped according to the origin of the under-performance and are presented in the following order:

- 8.1 Under-sizing of heat pump (example I)
- 8.2 Under-sizing of heat pump (example II)
- 8.3 Poor design of ground loop

- 8.4 Leaking ground loop
- 8.5 Ground loop temperature difference increasing
- 8.6 Incorrect sizing of domestic hot water cylinder sizing
- 8.7 High losses from the domestic hot water cylinder
- 8.8 Inadequate insulation of cylinder and pipework
- 8.9 Central heating flow temperature too high: radiator system
- 8.10 Central heating flow temperature too high: under-floor system
- 8.11 Excessive use of circulation pumps.

DECC has commissioned the Energy Saving Trust to carry out a study of the quality of glycol in a number of sites as part of Phase II of the project, which will be reporting in 2012. A further issue is the effect of thermostatic radiator valves on cycling and performance. EA Technology has undertaken investigations in controlled conditions in a test house. Both these reports are available on the DECC website and should be read in conjunction with this report.

8.1. Under-sizing of Heat Pump (Example I)

Figure 19 below shows the monthly distribution of system efficiency at site 477. This is an extreme example of under-sizing, shown here to indicate the problems that can arise if heat loss is incorrectly estimated. It is not typical of the systems in the trial.

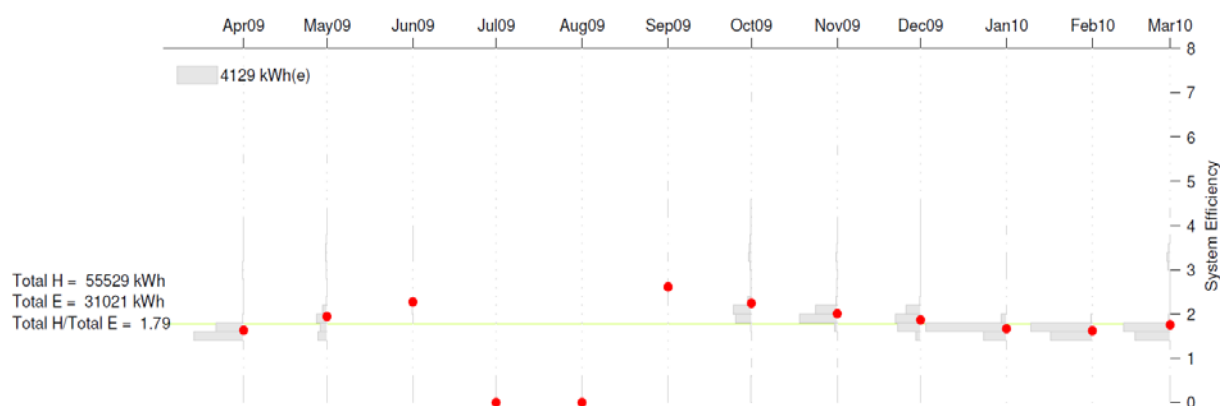

Figure 19: Monthly distribution of system efficiency for an under-sized heat pump (site 477)

At this site, an 8kW (nominal) ground-source heat pump provides space heating through radiators and an under-floor heating system for offices in a converted stable block, located in Gloucestershire. The ground loop constitutes boreholes and panel collectors. The site also has a 3kW air-source heat pump, but this did not function throughout the trial period, which accounts for the ground source heat pump being under-sized for the building. The office block is reported to have a low level of loft insulation, and has a SAP rating of 57 points (Band D).

The chart describes an extremely poor level of performance with a slight improvement through the summer months. This is explained when the quantity of heat produced and electricity consumed over short operating bursts are plotted against each other as in Figure 20 below.

Three distinct operating periods are identified. These correspond to the heat pump operating on its own; the heat pump + a 3kW direct-electric top-up heater; and the heat pump + two 3kW direct-electric top-up heaters. Different levels of direct-electric heating are provided by an integral two-stage electric heater in this heat pump.

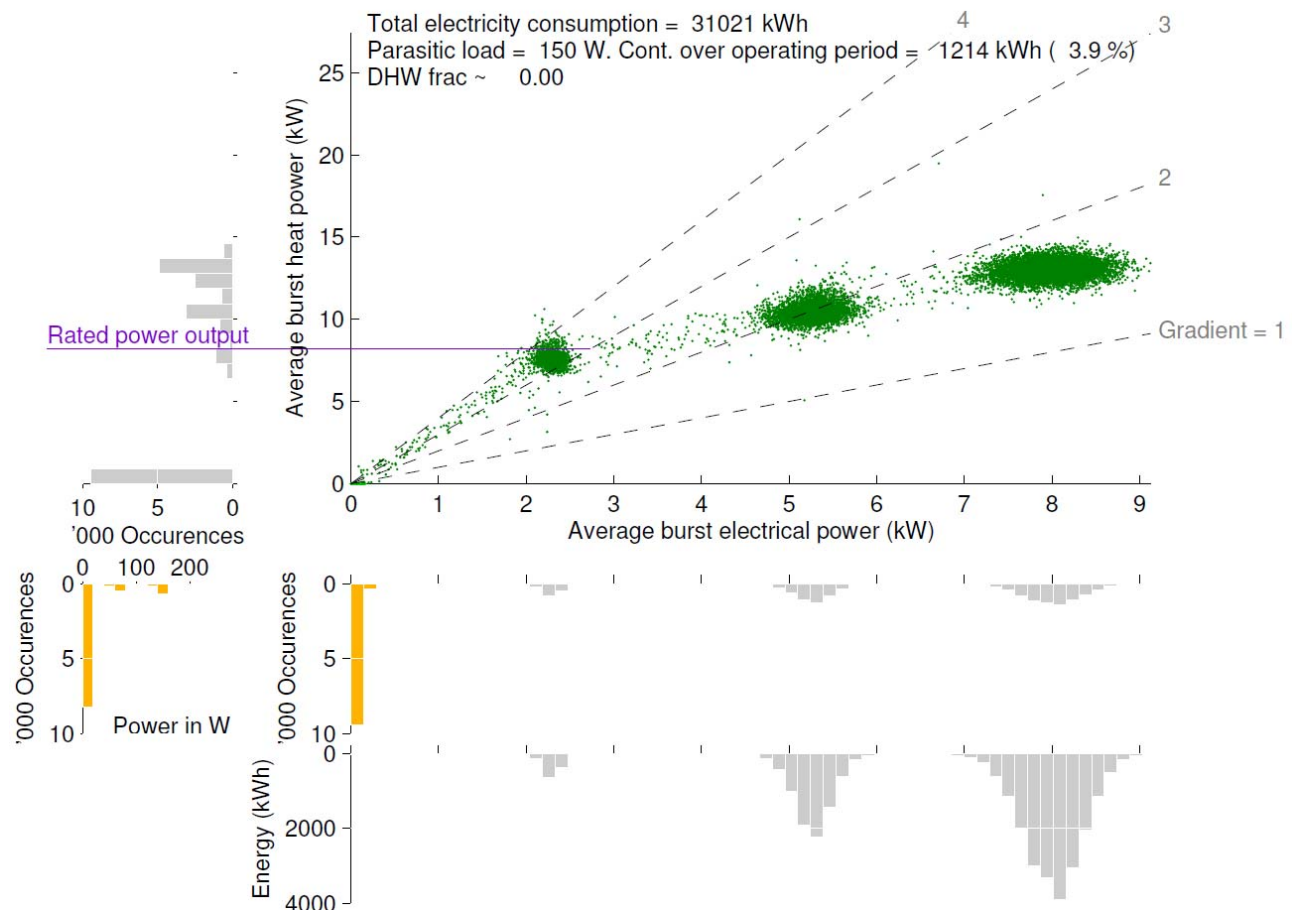

Figure 20: Scatterplot of heat power as a function of electrical power for an under-sized heat pump (site 477)

Explanation of figure: In the upper right corner is a plot of total electricity consumption against total heat production for 20-minute bursts of data. Points where both equal zero have been removed. Data that appears on a line between two points may be the average of a combination of periods where the heat pump was off and on. Histograms are plotted for both variables. An energy-weighted histogram is also shown for total electricity consumption. A zoomed histogram with 20W bin widths is shown in the lower left corner of the figure and used to estimate the parasitic (background) electricity consumption of the system. The fraction of the total electricity consumption which is parasitic is estimated and printed on the figure.

Viewed in this way, it is shown that the heat pump refrigerant cycle is operating as designed with a very good efficiency (between 3 and 4). However, the heat pump system is dramatically under-sized for the heat load, and so supplementary direct-electric heating is used. Consequently, the system has a very poor overall system efficiency (1.79, as shown in Figure 19).

From the location of the first cloud of points on the left of Figure 20, it can be seen that this heat pump could have operated with a system efficiency of 3.5 had it been correctly sized and the ground loop adapted to match.

This is an extreme example of under-sizing. When the field trial is viewed as a whole, there is no evidence of systematic under-sizing. As part of Phase II, the project team is currently undertaking SAP assessments of all the buildings in the trial. These results will be used to develop a distribution of building heat loss compared with the capacity of the heat pumps to meet heating demand. The results will be reported in 2012. The current working conclusion is that there are as many, if not more, over-sized heat pumps in this field trial as there are under-sized units.

8.2. Under-sizing of Heat Pump (Example II)

Site 416 is a modern, four-bedroomed house located in Dunbartonshire. The SAP rating is 77 (Band C). A 5kW ground-source heat pump extracts heat from a 300m horizontal ground loop, and supplies under-floor heating and domestic hot water. The house also has a wood-burning stove. The floor area is 226m², which equates to a maximum power delivery per unit floor area from the heat pump alone of 22W/m². This is an interesting case, because the house was designed to AECB¹³ low energy standards, which would imply a design heat demand of around 10W/m². In principle, therefore, the heat pump should be sufficient to supply all the heat required. In practice, however, there are times in December when the space heating power is around 8–10kW. This indicates that the electric boost is being used.

Figure 21 shows the monthly distribution of system efficiency. It can be seen that, during the winter months, this distribution is bi-modal, with one peak at around 4, and a second at around 2. The energy-weighted average system efficiency is 2.35.

¹³ Association for Environment-Conscious Buildings

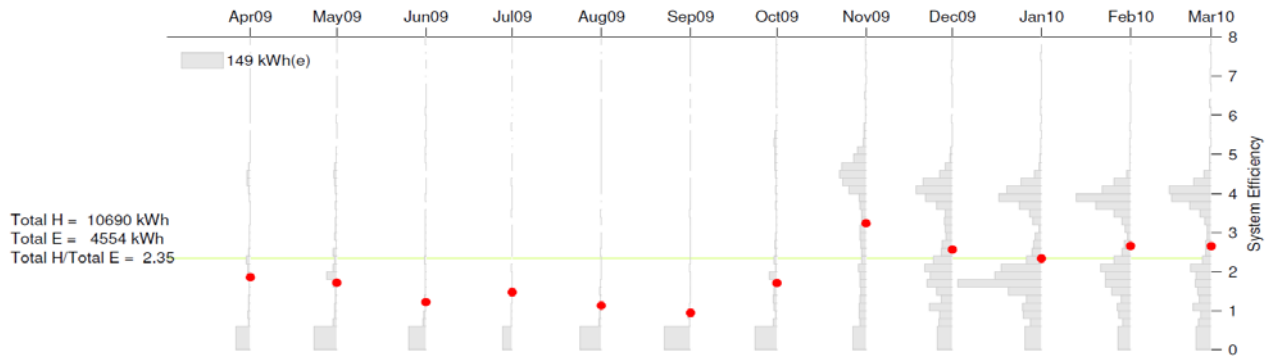

Figure 21: Monthly distribution of system efficiencies for ground-source heat pump (site 416)

Figure 22 shows a scatterplot of heat versus electricity input.

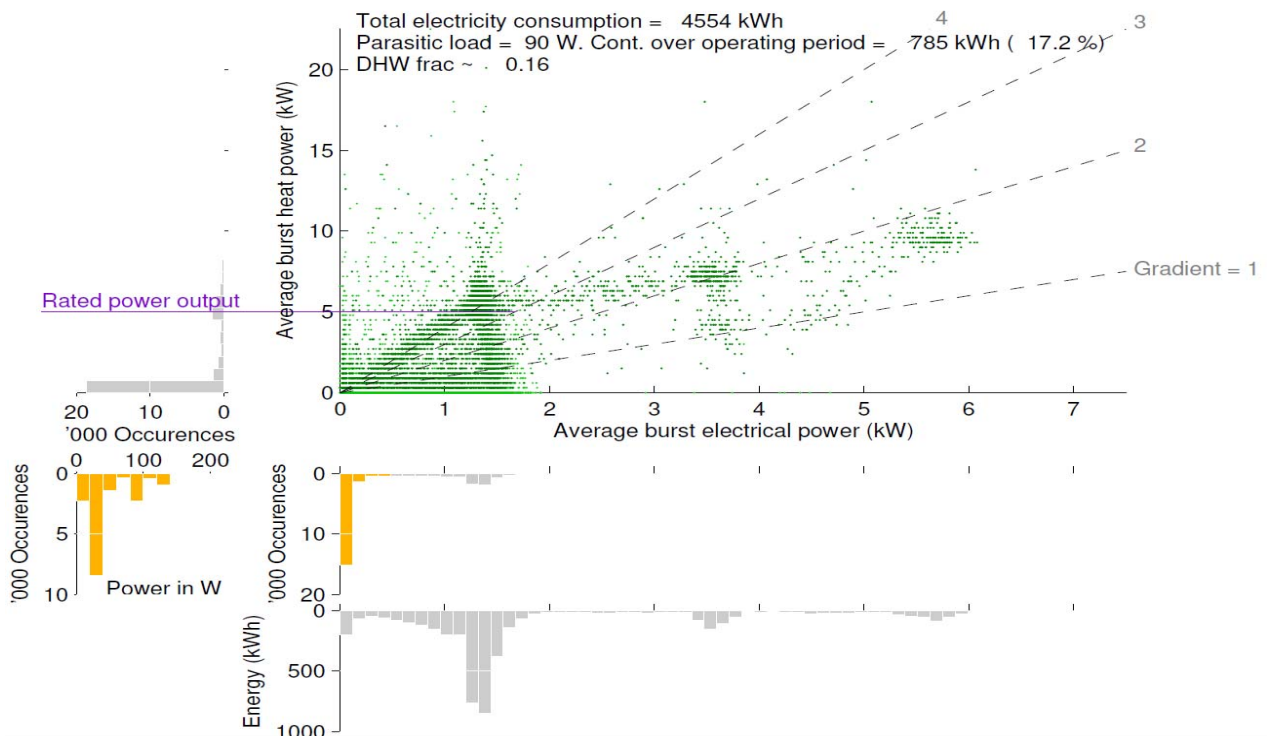

Figure 22: Scatterplot of heat power against electrical power for a ground-source heat pump (site 416)

Explanation of figure: Each point represents 20 minutes of data, and points for which the heat pump has switched on or off during this period are excluded. Below and to the left of the scatterplot are histograms of electricity usage and heat output. The lower of the two charts (in orange) shows a magnification of the histogram, near E = 0.

The scatterplot shows three distinct regions of points:

- A triangle of points for which electricity use $<2\text{kW}$. Along the hypotenuse of this triangle, the heat pump appears to be working as expected. The system efficiency is around 4. It is likely that the points along the horizontal axis and the almost vertical line are points during which the system is switching between space heating and hot water production.
- Points for which the electrical power is 3.5kW , and heat around 7kW (system efficiency = 2)
- Points for which electrical power is 5.75kW and heat output is around 8kW (system efficiency <2).

Clearly, the boost heater is responsible for the lower system efficiencies at high electrical input.

In this case, the heat pump is under-sized. With a larger heat pump, the boost heaters would be used less frequently, and the overall system efficiency would be greater.

8.3. Poor Design of Ground Loop

The most extreme example of incorrect ground loop operation is at site 471. This is a 1980s semi-detached house in Oxfordshire, with a SAP rating of 64 points (Band D). A nominally 11kW heat pump collects heat from coaxial boreholes that are reported to have been pushed into the ground. The heat pump supplies under-floor heating, radiators and domestic hot water.

Figure 23 below is a scatterplot of heat power as a function of electrical power for site 471. The gradient of the scatterplot of heat against electricity and location of most of the electrical energy consumption indicates that the system efficiency of this installation is between 2 and 3. The average system efficiency was 2.45 over the monitoring period. The zoomed histogram to the left of the scatterplot shows a 150W parasitic electrical energy consumption, which accounts for $\sim 10\%$ of the total energy consumption.

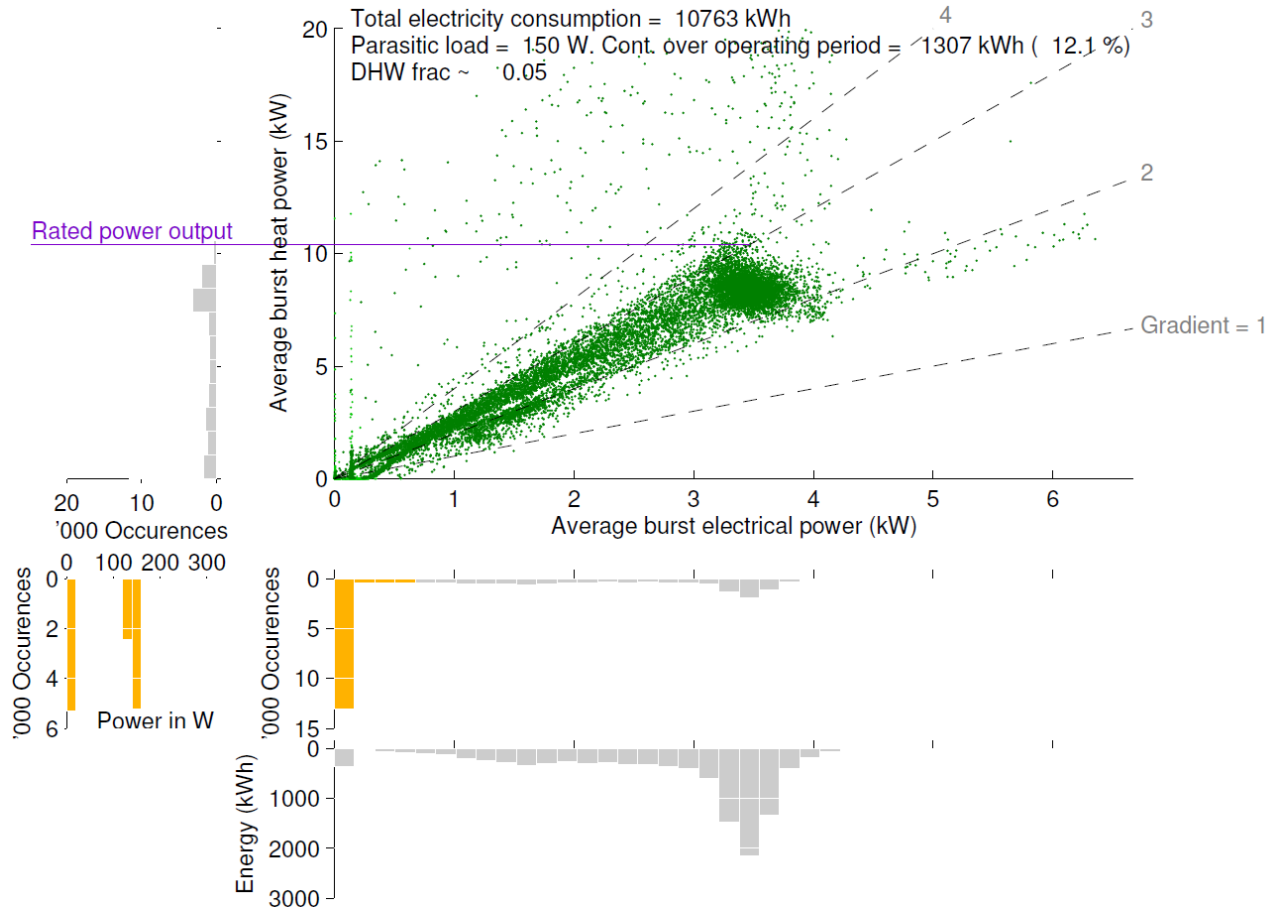

Figure 23: Scatterplot of heat power as a function of electrical power (site 471)

A system efficiency of 2.45 is reasonably high, considering the extremely low ground temperatures at this site.

Figure 24 shows the ground temperatures during some of the coldest conditions experienced during the year. A horizontal line marks -10°C . The manufacturer commented that this heat pump cuts out at this temperature for (compressor) frost protection purposes. During various site visits the householder has explained how he frequently has to manually reset the heat pump, possibly for this reason.

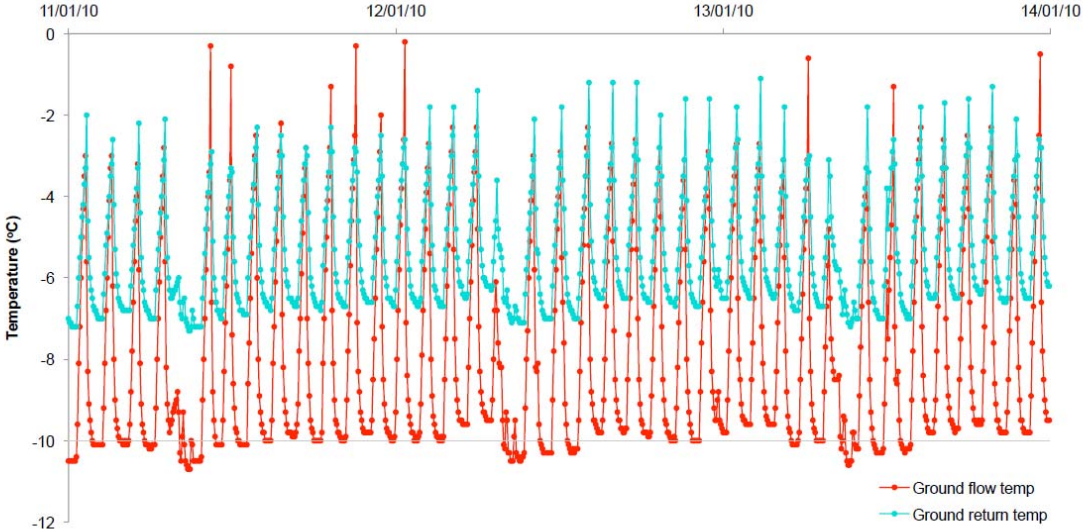

Figure 24: Winter ground flow and return temperatures (site 471)

The relationship between electricity consumption and heat production at different ground return temperatures is shown in Figure 25. Data from the manufacturer indicate that a greater rate of change of heat production with ground return temperature should be seen than the real data presented in this figure, but otherwise the comparison is reasonable. As these data are close to those provided by the manufacturer, the system efficiency that would have been achieved had the ground been returning at higher temperatures can be estimated with reasonable certainty. The measured instantaneous system efficiency is in the region of 3.2 when the ground return temperature is 2°C. As expected, the efficiency drops off at lower temperatures.

It is therefore possible to conclude that the boreholes are the reason for poor performance. If the boreholes had been correctly sized, the return temperature would have been kept above zero, and the average system efficiency is likely to have been greater than 3.

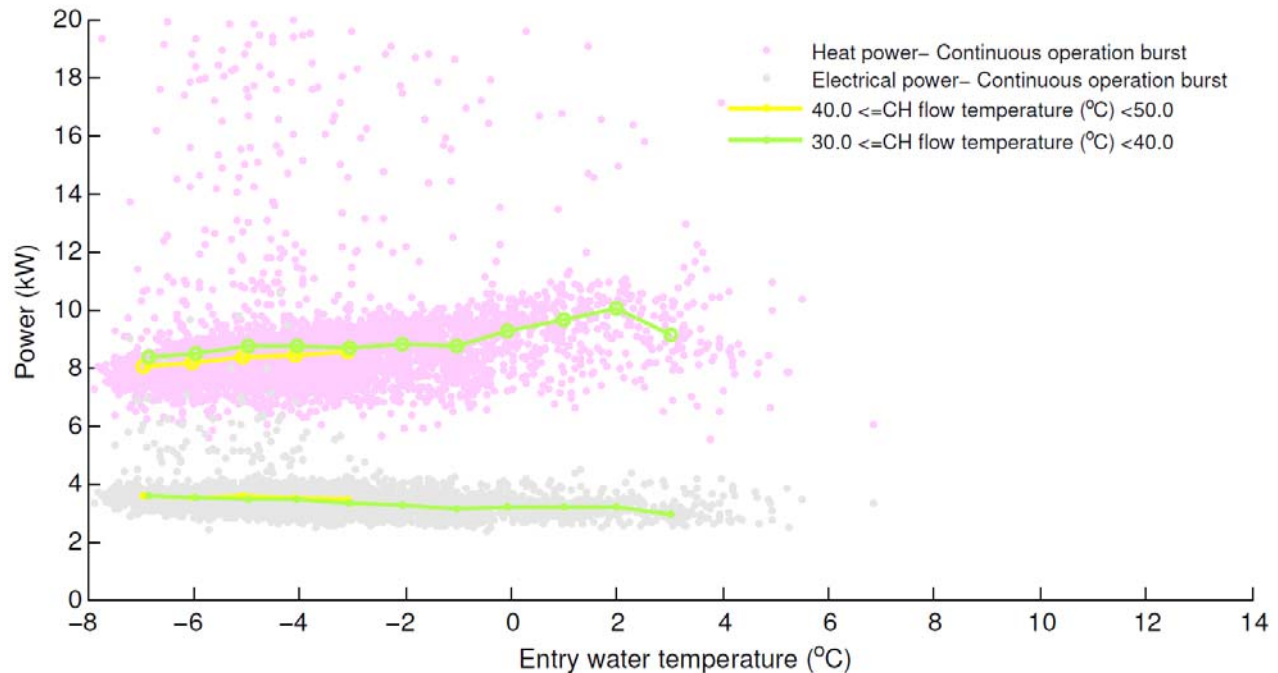

Figure 25: Heat and electrical power as a function of ground return temperature (site 471)

There are other boreholes in the field trial where the ground return temperature is sub-zero for most of the year. There is also evidence of poorly-sized horizontal ground collectors – see Section 9.

8.4. Leaking Ground Loop

Details of leaking ground loops have not been collected rigorously as part of Phase I of the trial and consequently it is difficult to prove whether or not a leaky ground loop has any impact on heat pump or system performance.

The greatest impact of a slowly leaking ground loop may be environmental. Evidence of ground loop leakage usually arises from conversations with householders. Site 421 was reported to have a ground loop that required regular topping-up. This heat pump had an annual system efficiency of 1.71 during the first year of measurement, but it was suspected that this was predominantly due to the control strategy, since the electric top-up heater was engaged too frequently and central heating flow temperatures were high.

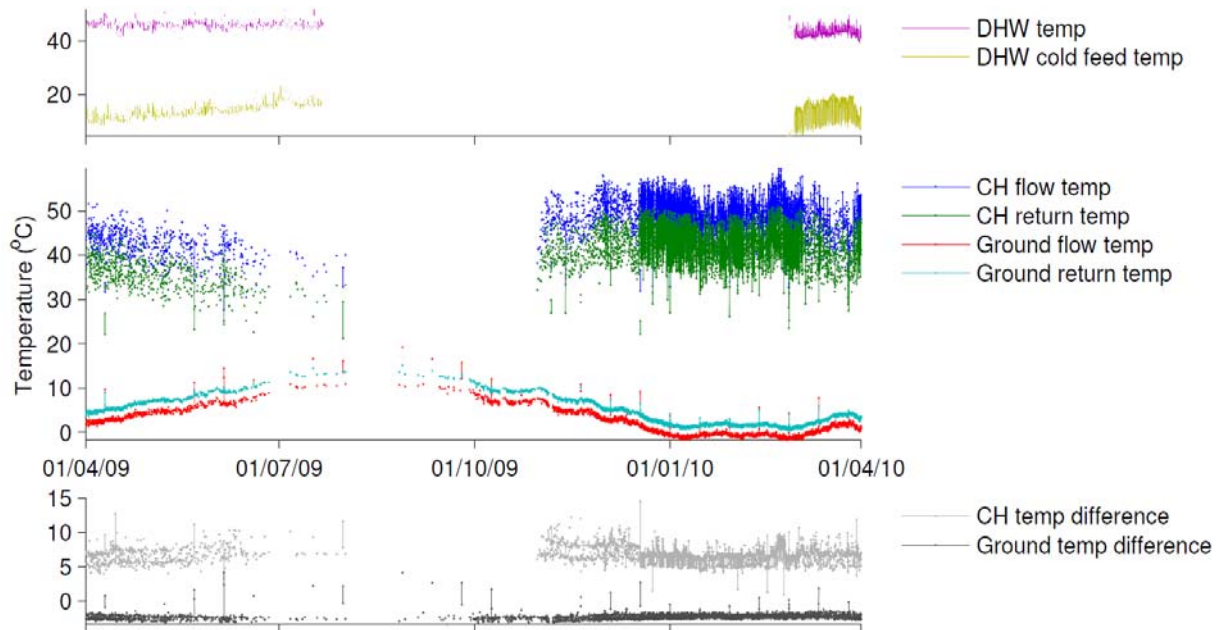

Figure 26: Ground flow and return temperatures (site 421) (suspected brine leak)

Figure 26 shows temperatures at various points in the heat pump system. The ground flow and return temperatures periodically rise to abnormal levels. These events correspond to weekends.

Further investigation showed that there was a leak in the connections above ground. This has been repaired. The site will be monitored for a further year as part of Phase II of the trials.

8.5. Ground Loop Temperature Difference Increasing

At two sites, the flow and return temperatures of the ground loop were seen to diverge dramatically over the monitoring period. One of these is site 436, a three-bedroomed semi-detached house located in Yorkshire. A 6kW (nominal) ground-source heat pump extracts heat from boreholes and provides domestic hot water and space heating through radiators.

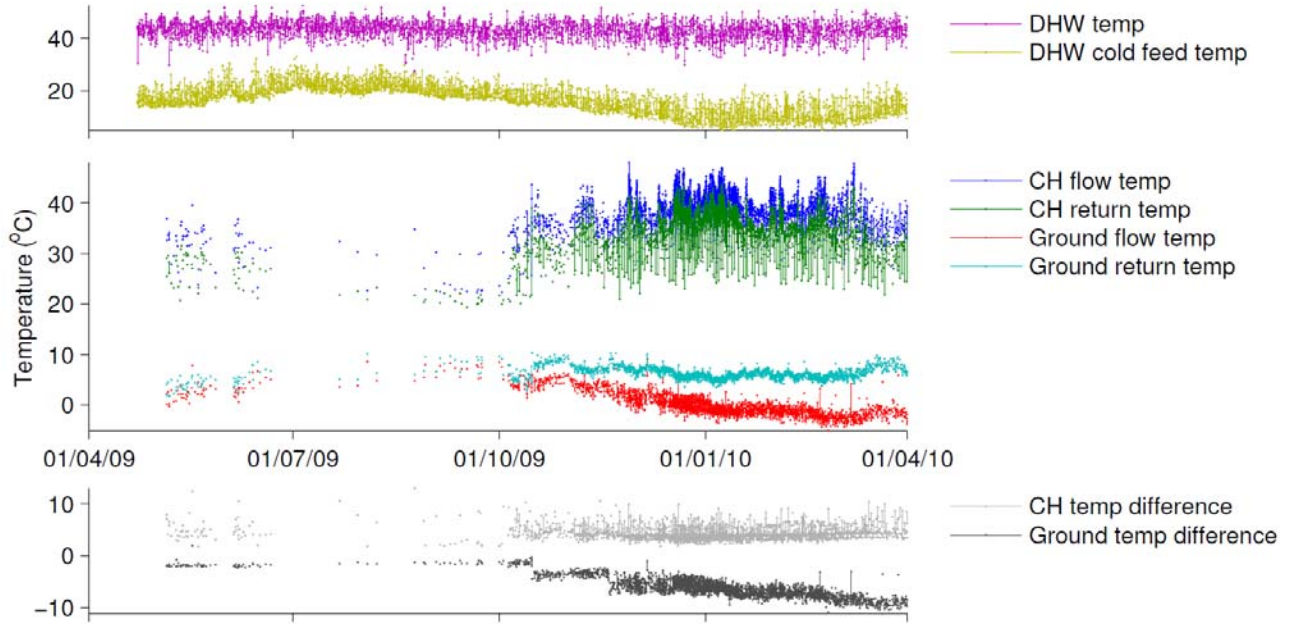

Figure 27: Ground flow and return temperatures (site 436), showing divergence during the winter months

Figure 27 shows the ground flow and return temperatures for site 436. The temperature divergence of the flow and return to and from the ground loop is clearly evident. By the end of the year, the temperature difference between the flow and return temperatures is 10°C. Distributions of system efficiency by month are shown in Figure 28. From this figure it is not obvious that the system efficiency is being measurably affected by these changing operating conditions.

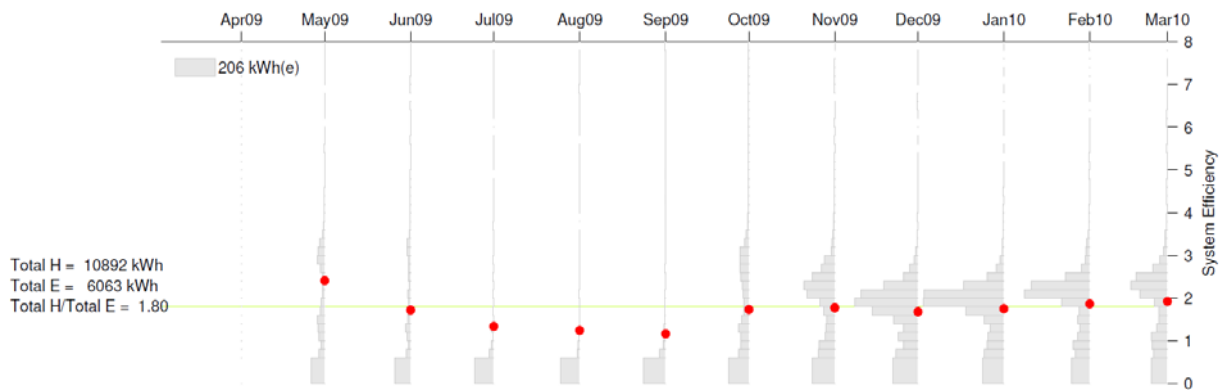

Figure 28: Monthly system efficiencies (site 436)

It is possible that the divergence of temperature was due to brine leakage or contamination. Unfortunately, this system was decommissioned before an analysis of the brine could be made.

8.6. Incorrect Sizing of Domestic Hot Water Cylinder

Site 487 is a three-bedroom semi-detached house, inhabited by a family of five. A nominally 8kW air-source heat pump, with a variable speed compressor, supplies domestic hot water and space heating through radiators.

The immersion element in the hot water cylinder is continuously used to increase the domestic hot water cylinder temperature to $\sim 70^{\circ}\text{C}$ as shown in Figure 29. This is intentional on behalf of the householder, in order to ensure that there is sufficient hot water to cover the needs of five people. The cylinder size is 140L.

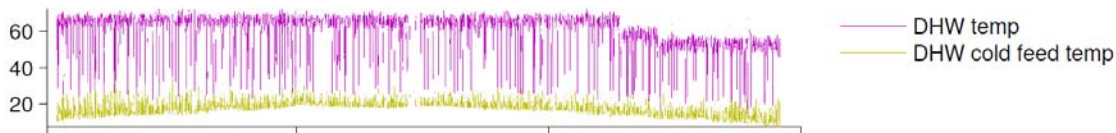

Figure 29: Domestic hot water cylinder temperatures (site 487)

The cylinder immersion electricity consumption has been monitored separately. Its impact can be seen in Figure 30 as areas where electricity is being consumed (domestic hot water cylinder heated) but where no heat is being used (system efficiency is equal to zero).

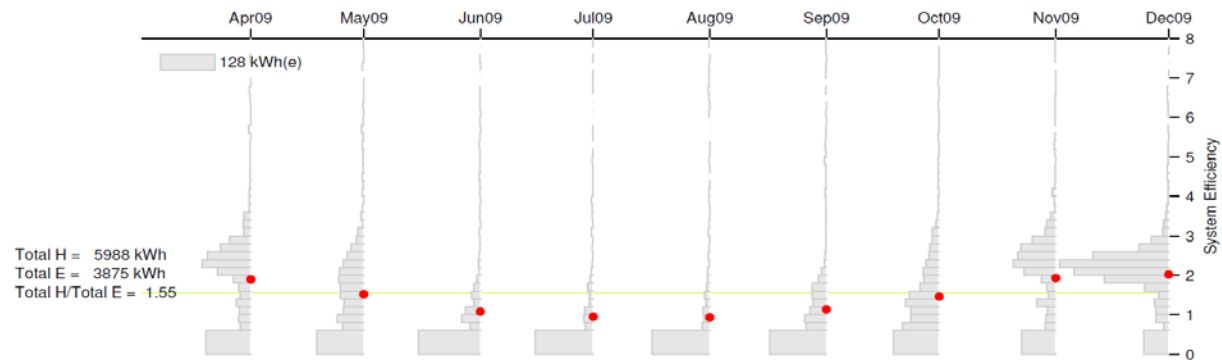

Figure 30: Monthly distribution of system efficiencies (site 487)

When the cylinder temperature was decreased in November, the blocks indicating immersion use decreased in size but remained significant. However, with the reduced temperature, the occupants ran out of hot water and so increased the cylinder temperature again. The heat pump manufacturer has since replaced the cylinder with a 200L cylinder, so that the occupants can store the same amount of energy at a temperature more suitable for the heat pump. A lower storage temperature should also reduce cylinder losses.

The total electricity consumption by this system was 3,875kWh over the operating period. The immersion consumed 1,815kWh (47%) of that energy. **Reducing this value by half could increase the system efficiency by up to 0.4.**

Appropriate sizing of the domestic hot water cylinder has important implications for system efficiency, and new guidance has therefore been developed in MIS 3005 Issue 3.1.

8.7. High Losses from the Domestic Hot Water Cylinder

It has been shown already that hot water cylinders that are too small can have a detrimental impact on system efficiency. In a small property, where the household uses a small amount of domestic hot water, cylinder losses may also become significant. In this trial, useful heat output is defined as the sum of the heat energy in the hot water used and the heat energy in the central heating (i.e. $H_{DHW_OUT} + H_{CH}$) as shown in the schematic in Figure 4.

The impact of significant domestic hot water cylinder losses is demonstrated effectively in three similar properties, all containing the same heat pump system. Site 460 is typical. It is a one-bedroomed semi-detached bungalow located in Cornwall. Figure 31 shows the configuration.

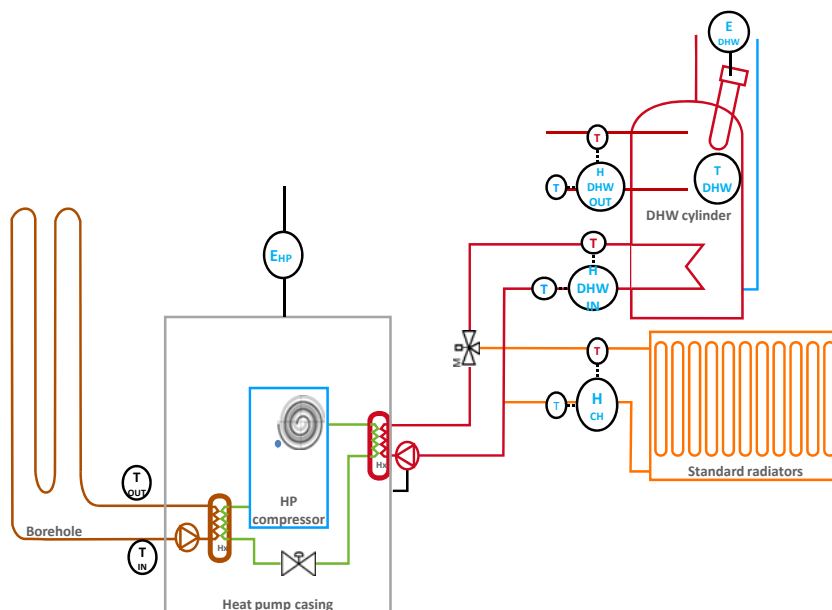

Figure 31: Site schematic (site 460)

A 3.5kW heat pump extracts heat from a single borehole and supplies radiators and a domestic hot water cylinder. The borehole's return temperature is above 3°C throughout the year. The refrigerant used in this heat pump's compressor enables provision of hot water without the use of an electric top-up or immersion heater but, importantly, this water is only used when running

taps because the property has an (unmetered) electric shower supplied by cold water from the mains, and the householder uses the shower in preference to the bath.

Table 7 shows data relating to domestic hot water production and use from three similar heat pumps in the same locality. The monitoring configuration is shown in Figure 31. The extra heat meter H_{DHW_IN} on the input to the domestic hot water cylinder is the component that enables this analysis.

Site	Heat used for DHW production (kWh)	Heat in DHW actually used (kWh)	% of useful heat	Cylinder losses (kWh)	Central heating heat (kWh)	Central heating + DHW using heat pump (kWh)	Central heating + instantaneous DHW heating (kWh)	Predicted saving (kWh)
460	882	153	17%	729	6,010	6,892	6,163	729
461	1,357	487	36%	870	2,893	4,250	3,380	870
464	574	84	15%	490	4,777	5,351	4,861	490

Table 7: Calculations of cylinder losses for three sites

The important column is the percentage of energy flowing into the domestic hot water cylinder that is subsequently used usefully. This value is 17%, 36% and 15% at the three sites. The impact of the losses on system efficiency at site 460 is demonstrated in Figure 32, where the bar at system efficiency = 0 corresponds to periods where the domestic hot water cylinder is being replenished. At site 460, just looking at the monthly system efficiency would be misleading, since its distribution is bi-modal.

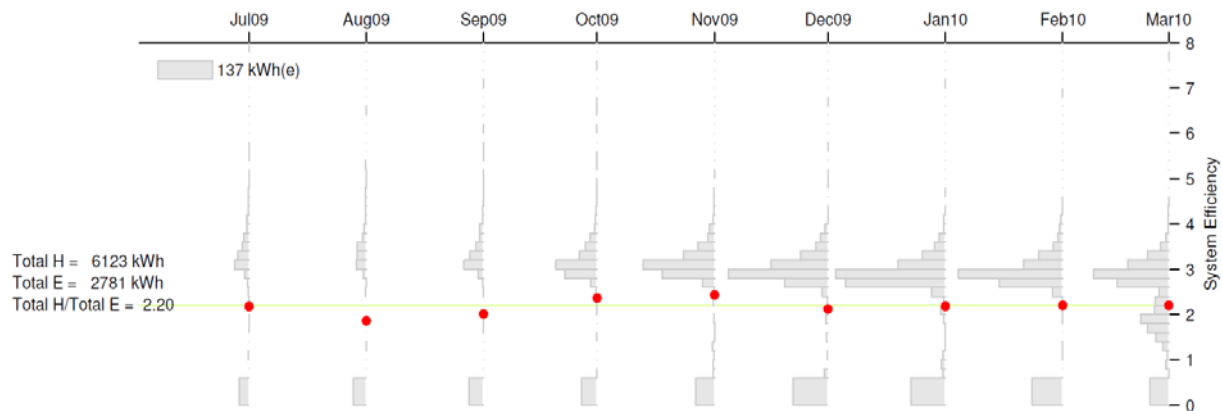

Figure 32: Distribution of system efficiencies for ground-source heat pump (site 460), showing the effect of high cylinder losses due to a relatively large cylinder and low hot water usage

It is possible to use the information in Table 7 to estimate the energy that would have been used in this house had the house been fitted with direct electric hot water appliances and the heat pump only used for space heating. Assuming that the heat pump's COP for domestic hot water

production is around 2.0,¹⁴ ~360kWh less electricity would have been used to provide the same amount of heat. The combined system efficiency of this revised system would therefore increase from 2.19 to 2.51.

A bi-modal distribution of 'instantaneous' system efficiency is evident in many of the systems in the field trial. Cylinder losses are particularly penalising in houses with a low heating requirement and/or large domestic hot water cylinder relative to the amount of domestic hot water being used on a regular basis.

8.8. Inadequate Insulation of Cylinders and Pipework

The effect of minimal insulation on pipework is clearly demonstrated at site 440. This property is a two-bedroomed terraced house. It has a 9kW (nominal) air-source heat pump supplying domestic hot water and space heating through radiators. The central heating circuit also contains a poorly insulated in-line buffer cylinder (one pipe in, one pipe out) in an uninsulated loft space.

Note that heat output is measured at the exit of the heat pump, buffer cylinder and domestic hot water cylinder (this is not the case at the majority of sites) as shown in Figure 33. There is another, unmetered output from the heat pump to the domestic hot water cylinder. Monitoring has been installed on this circuit to allow full evaluation of the heat pump COP in the second phase of the field trial.

¹⁴ As measured on 10/09/2010, and considered to be a typical value. Note: this is the COP for domestic hot water production, not the system efficiency, i.e. it is based on the **input** heat to the domestic hot water cylinder.

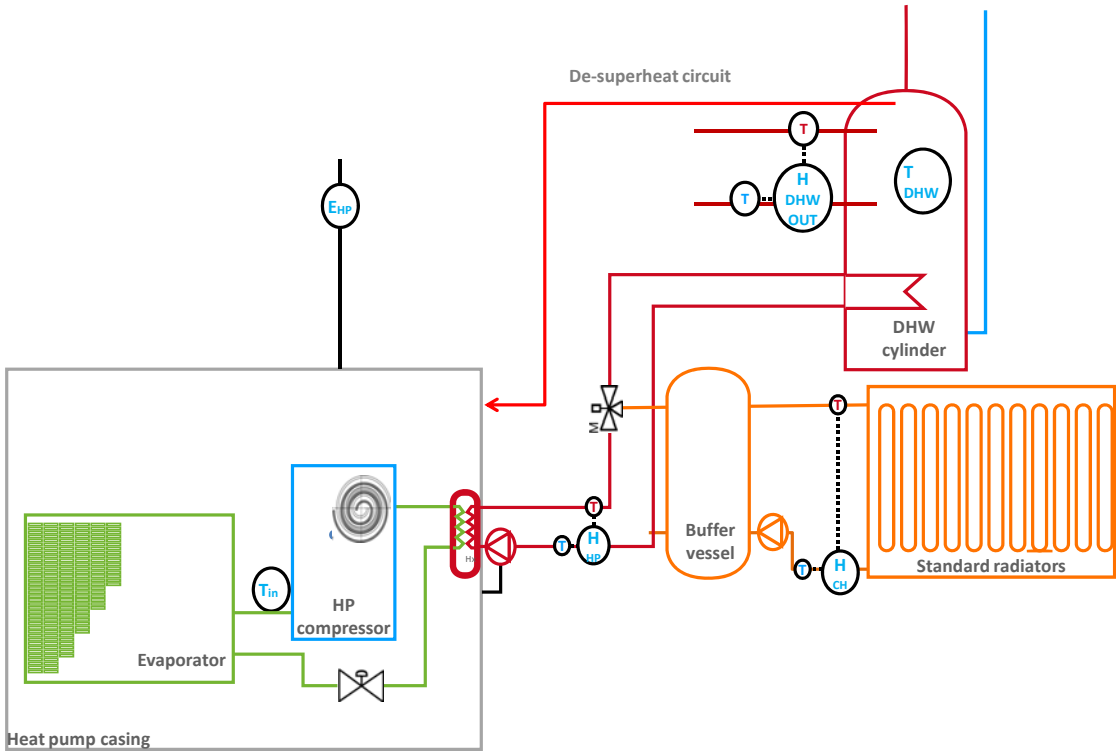

Figure 33: Site schematic (site 440)

The scatterplot of heat versus electricity (Figure 34) has been modified to include the output from the heat pump (H_{HP} , shown as the orange points) as well as the combined output of the central heating and domestic hot water outputs ($H1 + H2$, in green). It can be seen that the heat pump efficiency is significantly higher than the system efficiency. The heating circuit design allows relatively long periods of continuous operation at this site so 1-hour averaging periods have been used when plotting these data.

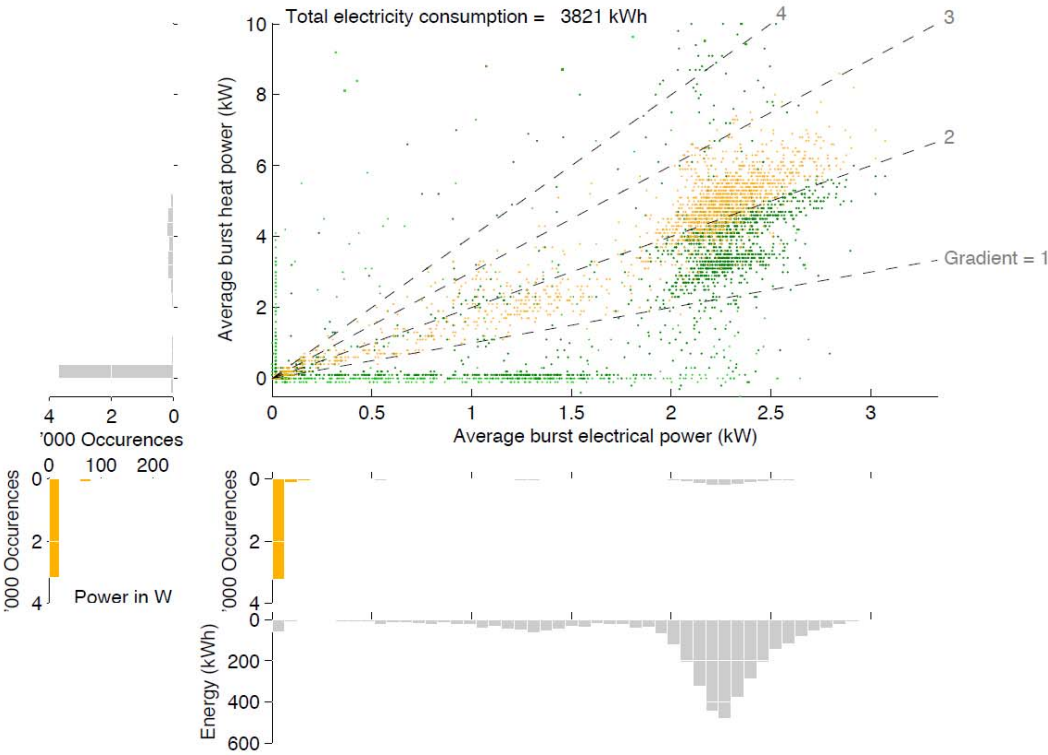

Figure 34: Scatterplot of heat power as a function of electrical power for an air-source heat pump (site 440)

Approximately 1kW of heat output is lost between the output of the heat pump and the entry to the heating circuit. This is shown in Figure 34, where the heat pump output has been plotted as orange dots whenever the unit is producing space heating.

Heat energy used for defrost can also be seen in the figure as points with a negative heat output. Looking at the graph, the impact on system efficiency is the difference between 1.55, the average value measured over the year, and perhaps 2.1.

A surprisingly high number of buffer cylinders and domestic hot water cylinders are located in unheated areas in this trial. Site inspections have also frequently revealed poor levels of insulation on pipework, so it is anticipated that losses of this type are reasonably common.

It is worth noting that, although low insulation levels lead to poor system efficiency, the use of a de-superheater means that it is possible to heat domestic hot water to a higher temperature than the central heating flow temperature. Thus, in principle, this design may avoid the need for an immersion heater in the hot water cylinder.

8.9. Central Heating Flow Temperature Too High: Radiator System

Carnot's theorem states that the maximum efficiency of a reversible heat engine between two heat reservoirs at temperatures T_{hot} and T_{cold} respectively is:

$$COP_{HP} = \left(\frac{1}{1 - \frac{T_{cold}}{T_{hot}}} \right)$$

Where:

COP_{HP} = coefficient of performance of the heat engine

T = absolute temperature.

It can therefore be seen that heat pump efficiency (and output) increase with lower condenser temperatures (T_{hot}). For this reason, it is common to use 'external weather compensation', whereby the temperature of the fluid following into the emitter circuit is modulated down in warmer weather. An example of some moderately high radiator temperatures without external temperature compensation is found at site 442. This is a three-bedroomed semi-detached house located in Cheshire, with an air-source heat pump providing space heating only. The distribution of system efficiencies by month is shown in Figure 35.

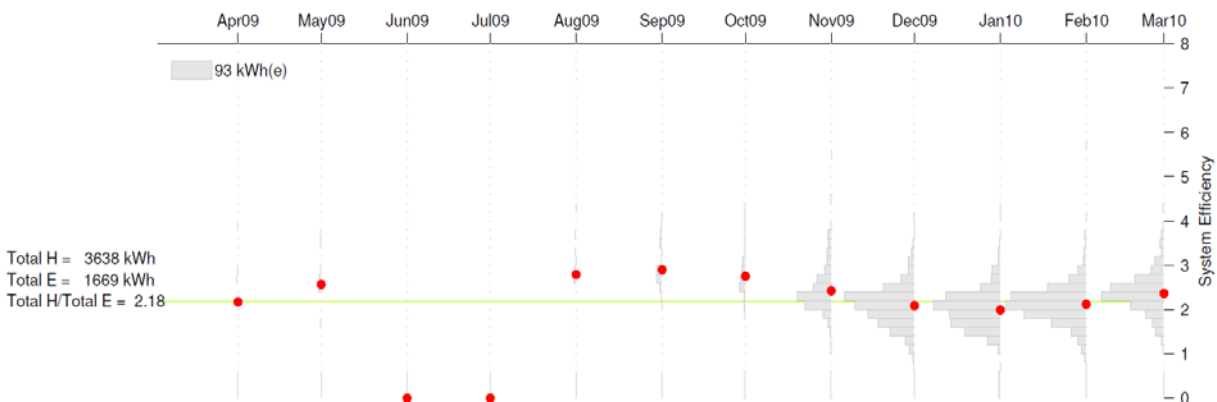

Figure 35: Monthly distribution of system efficiency for an air-source heat pump (site 442)

The overall system efficiency is 2.18, which is higher than the average system efficiency of the air-source units in the field trial, but this case study indicates that performance could be further improved. Figure 36 examines the compressor operating conditions and is particularly revealing at this site. The chart shows how central heating temperature is almost independent of evaporator temperature at this installation, which is not the case for the majority of the units in the field trial; most use external temperature compensation to reduce the central heating flow temperatures in warmer conditions for the reasons discussed previously. The manufacturer had

turned off external temperature compensation at this site to avoid complaints about low-temperature radiators from the householders. Central heating temperatures are between 45°C and 50°C.

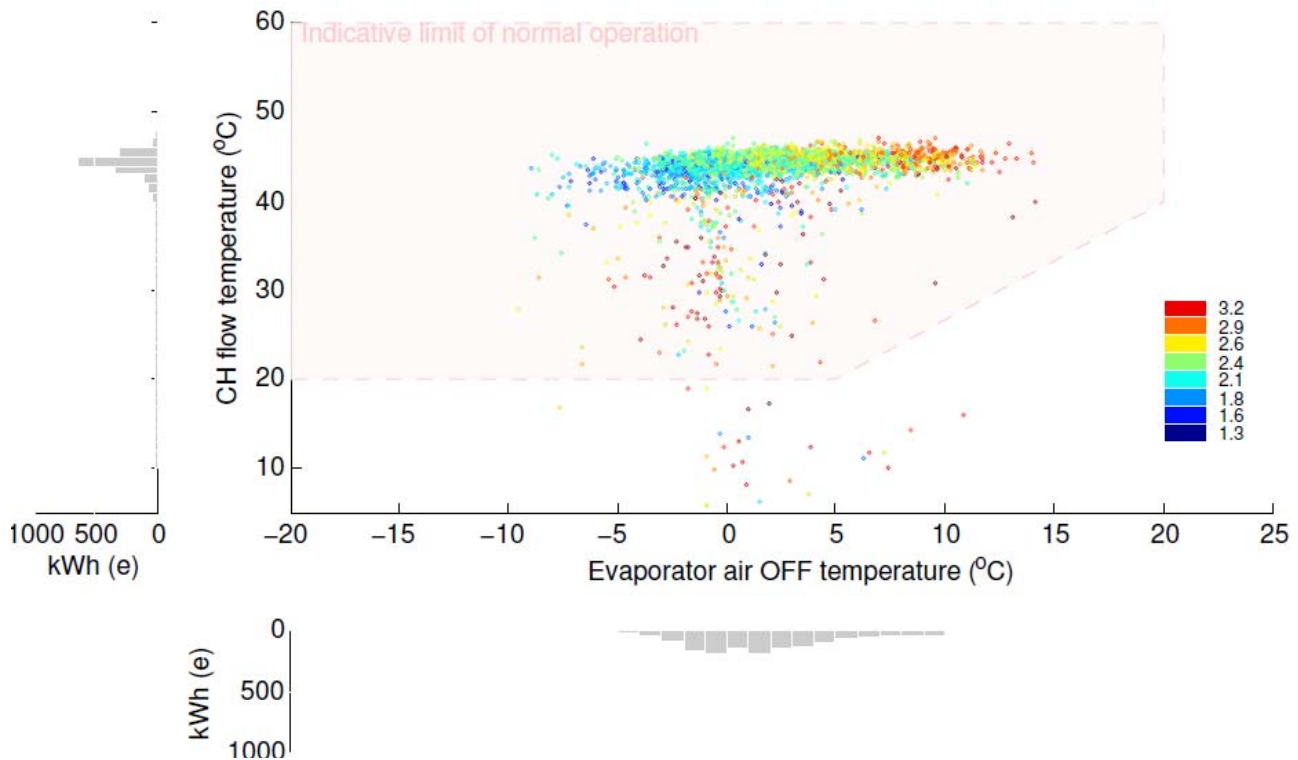

Figure 36: Scatterplot of central heating and evaporator air off temperatures for an air-source heat pump (site 442)

Power data provided by the manufacturer agree reasonably well with this information, although the unit cycles extremely rapidly and it is therefore hard to assess steady operating conditions. Using a combination of the manufacturer's data and measured data, additional analysis is being performed on this site to assess the theoretical benefit of lowering radiator temperatures.

Preliminary results indicate that reducing the maximum central heating temperature to 43°C at an evaporator temperature of -15°C (by modifying radiators as required) and linearly decreasing the radiator flow temperature to 35°C at 7°C evaporator temperature (this may be too low to maintain comfort) could increase the system efficiency by 0.2.

A desire to reduce the central heating flow temperature is one of the most common outcomes of meetings that have been held with manufacturers. There have been various proposals for doing so:

- larger radiators
- increased number of radiators
- changing radiator type
- top-feeding (cross-feeding) radiators

- low-temperature emitters (forced-convection radiators).

The impact of all of these options will be measured in Phase II of the field trial and reported in 2012.

8.10. Central Heating Flow Temperature Too High: Under-floor System

Site 415 is a modern five-bedroomed detached house located in Stirlingshire, with a SAP rating of 71 points (Band C). Heat is supplied to under-floor heating and domestic hot water by an 11kW ground-source heat pump, which extracts heat from three ground loops, each 200m long and 1m deep. The house also has mechanical heat recovery. Figure 37 shows the distribution of system efficiency by month.

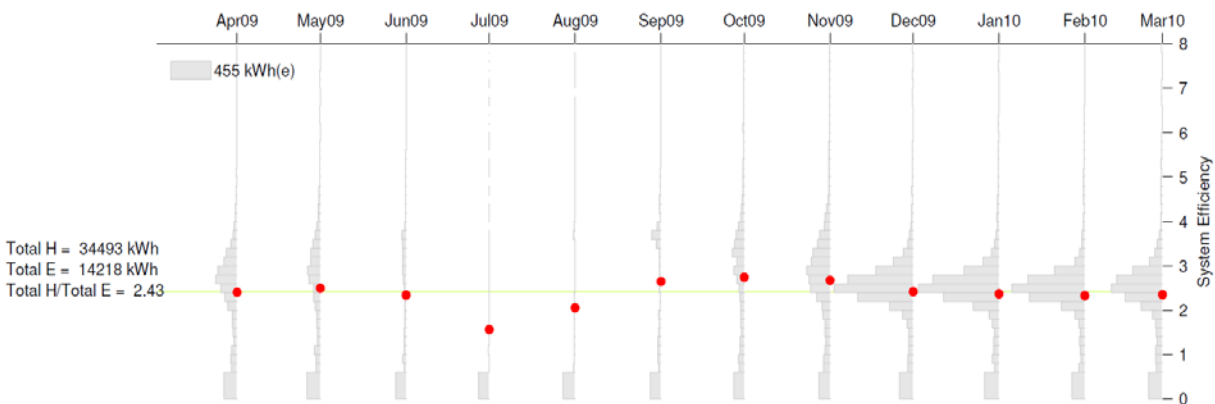

Figure 37: Monthly distribution of system efficiency for a ground-source heat pump (site 415)

The system efficiency is 2.43 over the monitoring period, which is about average for ground-source systems in this field trial.

The temperatures at various points in the system are shown in Figure 38. This heat pump cycles rapidly; the central heating flow temperature rises to 50°C or higher by the end of each cycle.

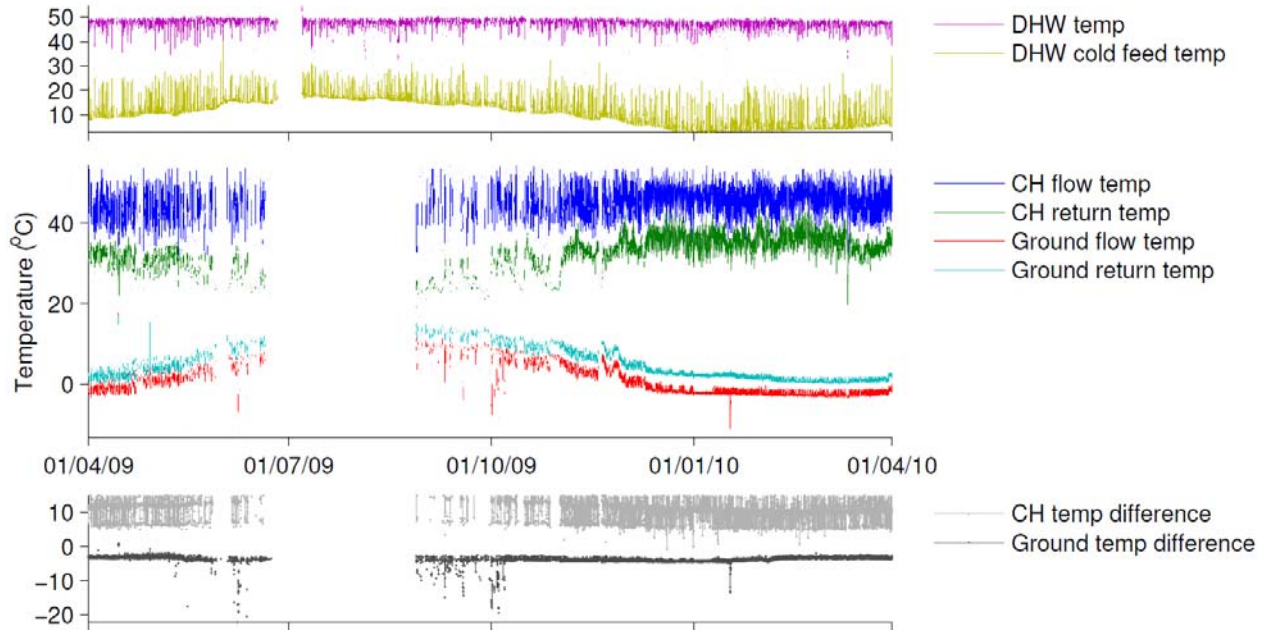

Figure 38: Flow and return temperatures for under-floor heating (site 415)

It is unclear why the under-floor temperature is so high at this site, but the most likely reason is that the separation between the under-floor heating pipes may be large. In this case, a high temperature flow is required to provide sufficient heating. Alternatively, the floor may have a thick carpet or rug, which is restricting the heat output.

The Heat Emitter Guide in MIS 3005 Issue 3.1 provides guidance on the appropriate separation of pipes in under-floor heating systems for different floor constructions and coverings.

8.11. Excessive Use of Circulation Pumps

Site 433 is a one-bedroomed bungalow located in Yorkshire, with a SAP rating of 58 points (Band D). A 4kW ground-source heat pump supplies heat to radiators and domestic hot water. During the measurement period, the total electricity consumed was 3,014kWh, and the heat emitted was 5,420kWh.

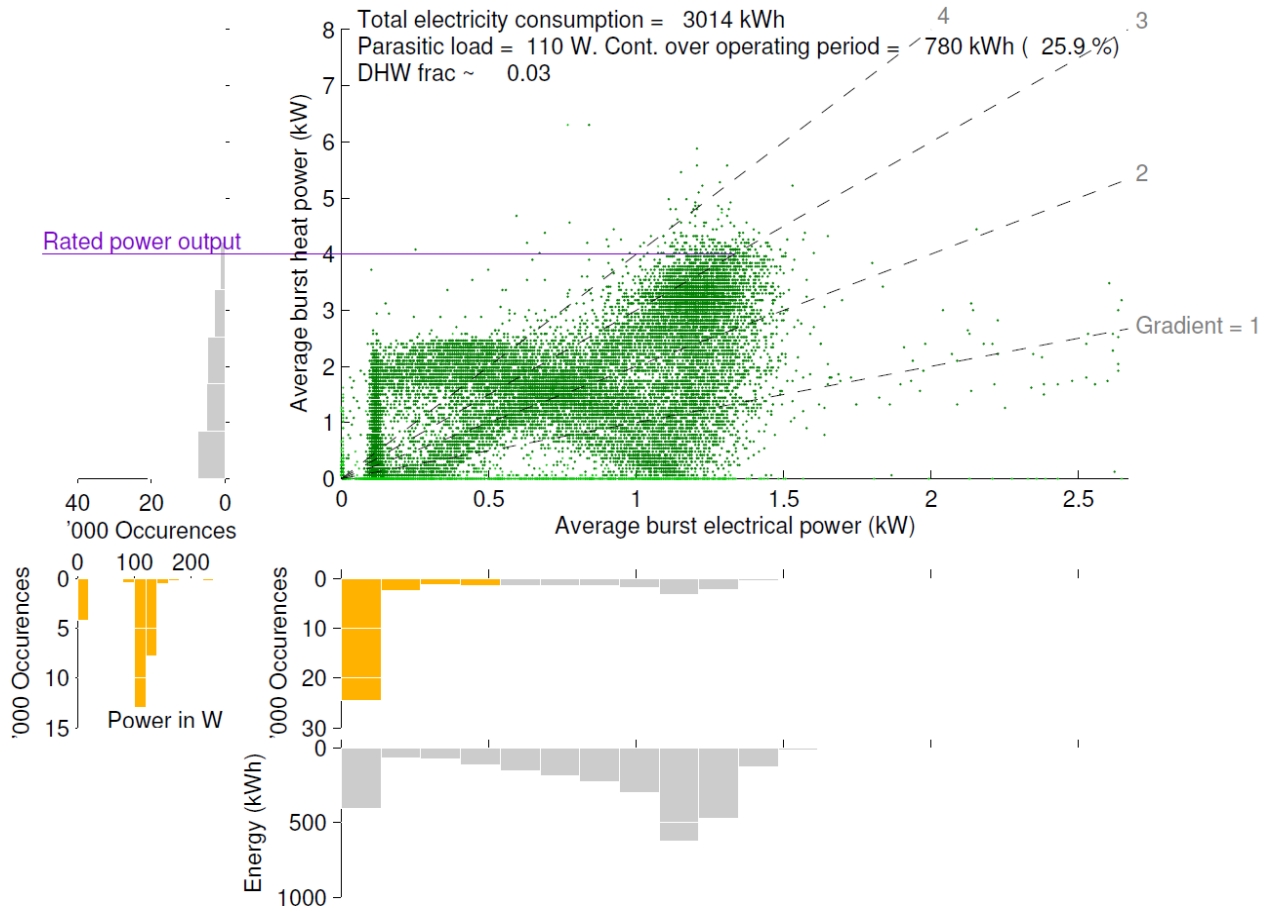

Figure 39: Scatterplot of heat power as a function of electrical power (site 433)

The scatterplot of heat power against electrical power is complicated, but shows a clear vertical line of points at 110W of electrical consumption. This represents the circulation pumps for the space heating circuit, which consumed 780kWh, or 26% of the total electricity consumption. Around 400kWh of this consumption occurred when the heat pump was off. If the control strategy were modified to ensure that the circulation pumps were used only when required, the system efficiency would improve from 1.8 to 2.08. A further improvement to 2.17 could be achieved by replacing the 110W pump with a 90W pump.

The control strategy some heat pumps use requires a continuous measurement of space heating return water temperature. For small systems such as site 433, this can severely impact the overall system efficiency. The problem should be less marked for higher capacity, high run hours systems.

Appropriate choice and operation of circulation pumps has important implications for system efficiency, and new guidance has therefore been developed in MIS 3005 Issue 3.1.

9. Examination of Boreholes and Ground Loops in the Trial

Figure 40 shows the results of an examination of all the ground-source heat pumps in the Energy Saving Trust trial. Elements of the bar chart are coloured according to the minimum ground return temperature; light blue elements indicate minimum ground return temperatures above zero, while the darkest blue elements indicate minimum ground return temperatures of < -6 degrees. Underlined systems are horizontal loops or slinkies, and systems marked with a 'P' have panels for recharging the ground heat. Systems in red text are Swedish heat pumps; these are noted separately, since DECC wished to examine whether the software used was appropriate for the UK. Systems in red text are Swedish heat pumps; these are noted separately, since DECC wished to examine whether the software used was appropriate for the UK.

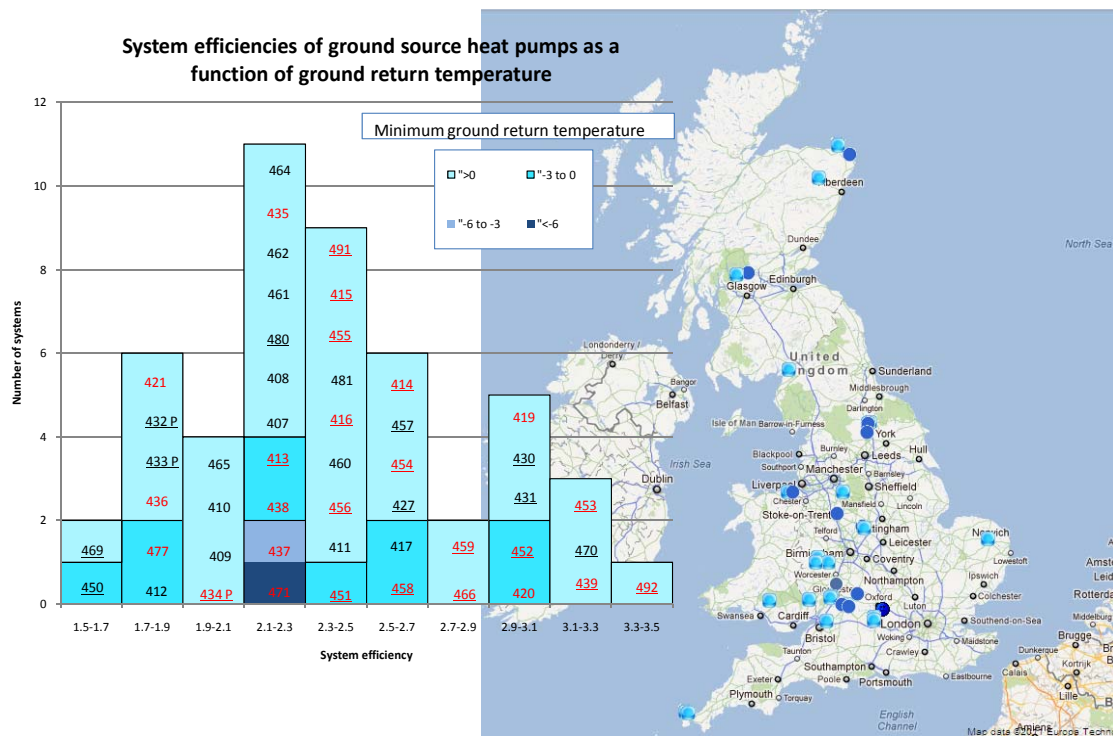

Figure 40: Distribution of system efficiencies of ground-source heat pumps in the trial

Explanation of figure: In this distribution of system efficiencies of ground-source heat pumps, cells have been shaded according to the minimum ground return temperatures observed during the measurement period, with the darker colours representing lower minimum ground temperatures. Identifiers of ground source heat pumps with horizontal loops are underlined, and identifiers of Swedish ground source heat pumps are shown in red text. 'P' indicates that a panel is used for re-charging the ground heat.

The chart shows that 12 of the systems have minimum flow temperatures <math><-3^{\circ}\text{C}</math>. Of these, half are borehole systems and half use horizontal loops or slinkies. These systems are not concentrated geographically. There are various possible explanations for the low minimum flow temperatures including:

- undersized ground loops/boreholes
- poor hydraulic design
- micro-bubbles in the ground loop fluid
- poor grouting.

There is no evidence to suggest that boreholes/horizontal loops fitted to Swedish heat pumps in the trial are any more or less likely to perform badly than those fitted to other heat pumps.

It is worth noting that some of the systems with correctly sized boreholes or slinkies also have relatively poor performance (system efficiency <2.6). This is due to other factors (as discussed in the remainder of the document).

Finally, it is important to note that this analysis demonstrates only whether the borehole or horizontal loop was appropriate for the heat pump in question; if that heat pump is under-sized for the property, then the borehole will be under-sized for the property.

10. Revision of MIS 3005 Installation Standards for Heat Pumps

The analysis presented in Section 8 indicates that, in many cases, performance could have been improved if appropriate installation practices had been followed. As a result of this analysis, DECC and the Energy Saving Trust convened a sub-group of heat pump experts to develop more robust guidance for installation. Following a number of meetings, the MIS 3005 standard (Requirements for contractors undertaking the supply, design, installation, set to work commissioning and handover of microgeneration heat pump systems, Issue 2.0) has been updated to Issue 3.1. The principal changes that have been made are:

- heat pump sizing
- ground loop sizing
- selection of emitters.

A number of more minor changes have also been made.

MIS 3005 Issue 3.1 can be downloaded from:

www.microgenerationcertification.org/installers/installers

10.1. Heat Pump Sizing

Sizing is the most complex issue tackled in the revised standards. It is important to bear in mind three factors which explain why the revised procedures for sizing in the UK differ from those in some other countries. These factors are: the need to avoid over-stressing the grid on a cold winter's day, the current high carbon coefficient of electricity in the UK and the high cost of electricity for consumers. These three factors mean that the use of direct electric heating should be minimised.

MIS 3005 Issue 3.1 states:

4.2.1 The following procedure shall be followed for the correct sizing and selection of a heat pump and related components for each installation:

- a) A heat loss calculation should be performed on the building using a method that complies with BS EN 12831.*

- b) Heat loss calculations shall be based on the internal and external temperatures specified in this document in Tables 1 and 2¹⁵. Heat loss through the floor shall be determined using the local annual average external air temperature in Appendix B¹⁶ (reproduced here as Appendix 3).*

Table 1¹⁷ is reproduced from the UK national annex to BS EN 12831. Clients should be consulted to establish whether they have any special requirements and the internal design temperatures increased if required.

Room	Internal design temperatures (°C) from the UK national annex to BS EN 12831
Living room	21
Dining room	21
Bedsitting room	21
Bedroom	18
Hall and landing	18
Kitchen	18
Bathroom	22
Toilet	18

Table 8:¹⁸ Internal design temperatures from the UK annex to BS EN 12831. CIBSE Guide A should be consulted for data for other applications. CIBSE Guide A also

¹⁵ Note: Tables 1 and 2 of the MCS MIS3005 Issue 3.1 report have been reproduced here as Tables 8 and 9.
¹⁶ Note: Appendix B of the MCS MIS3005 Issue 3.1 report has been reproduced here as Appendix 4.
¹⁷ See note 14.

contains information on how to adapt these data for non-typical levels of clothing and activity.

Table 9¹⁹ is reproduced using selected data from Table 2.4 in the Chartered Institution of Building Services Engineers (CIBSE) Guide A. These values are the hourly dry-bulb temperatures equal to or exceeded for 99% of the hours in a year. In the absence of more localised information, data from the closest location may be used, decreased by 0.6°C for every 100m by which the height above sea level of the site exceeds that of the location in the table.

Location	Altitude (/m)	Hourly dry-bulb temperature (°C) equal to or exceeded for 99% of the hours in a year
Belfast	68	-1.2
Birmingham	96	-3.4
Cardiff	67	-1.6
Edinburgh	35	-3.4
Glasgow	5	-3.9
London	25	-1.8
Manchester	75	-2.2
Plymouth	27	-0.2

Table 9:²⁰ Outside design temperatures for different locations in the UK. Corrections can be applied to account for altitude and heat island effects. Further information on how to adapt and use these data is available in CIBSE Guide A: Environmental Design.

Monthly and annual average air temperatures for various UK regions are provided by the MET office in Appendix B²¹ (reproduced here as Appendix 3).

c) A heat pump shall be selected that will provide at least 100% of the calculated design space heating power requirement at the selected internal and external temperatures, the selection being made after taking into consideration the space heating flow temperature assumed in the heat emitter circuit and any variation in heat pump performance that may result. Performance data from both the heat pump manufacturer and the emitter system designer should be provided to support the heat pump selection. Heat pump thermal power output for the purposes of this selection shall not include any heat supplied by a supplementary electric heater.

¹⁸ See note 14.

¹⁹ See note 14.

²⁰ See note 14.

²¹ See note 15.

d) When selecting an air-source heat pump, the heat pump shall provide 100% of the calculated design space heating power requirement at the selected ambient temperature and emitter temperature, after the inclusion of any energy required for defrost cycles.

e) For installations where other heat sources are available to the same building, the heat sources shall be fully and correctly integrated into a single control system. A heat pump shall be selected such that the combined system will provide at least 100% of the calculated design space heating requirement at the selected internal and external temperatures, the selection being made after taking into consideration the space heating flow temperature assumed in the heat emitter circuit and any variation in heat pump performance that may result. Heat pump thermal power output for the purposes of this section shall not include any heat supplied by a supplementary electric heater within the design temperature range.

4.2.2 For installations where other heat sources are available to the same building, it shall be clearly stated by the contractor what proportion of the building's space heating and domestic hot water has been designed to be provided by the heat pump. The figures stated (i.e. the proportion of the annual energy provided by the heat pump) shall be based only on the energy supplied by the heat pump and shall not include any heat supplied by a supplementary electric heater.

Notes on section 4.2.1 – Part C

Sizing a system to precisely 100% as defined in section 4.2.1 part c) will require supplementary space heating for the coldest 1% of the hours in a year. In addition, the system may require the use of supplementary heating if:

- The building is being heated from a cold state;*
- The desired heating mode is not continuous, such as bi-modal heating or heating using a split-rate tariff;*
- Large quantities of domestic hot water are required frequently during cold weather.*

Installers trying to design a system capable of achieving these requirements without supplementary heat should consider increasing the heating capacity of the heat pump.

The clause in section 4.2.1 (c) requires the CIBSE external design temperature to be the temperature at which the heat pump heating capacity at least matches the building design load.

1st example of an installation that fulfils Clause 4.2.1 – Part C

An average-size, 3-bedroom, semi-detached, well-insulated property is calculated to have a 6.2kW heat loss using BS EN 12831 and the internal, external and ground temperatures provided in this standard. The property is connected to a single-phase electricity supply.

Two heat pumps are available; one has an 8.4kW heat output at the local design external temperature (from CIBSE guide A) and the calculated emitter temperature; and the other has a 4.1kW heat output, with a 3kW supplementary electric heater.

Under the rule in clause 4.2.1 (c) (i.e. the 100% sizing rule), the heat pump should provide at least 100% of the design load at the design temperatures in section 4.2.1 (b) without the inclusion of any supplementary electric heater.

The second heat pump, whose total heat output is sufficient to meet the building heat loss but includes a 3kW supplementary electric heater, does not meet this rule; therefore, the first heat pump is selected for this job, even though it delivers more than the calculated heat loss at design conditions.

Notes on section 4.2.1 – Part C (continued...)

2nd example of an installation that fulfils Clause 4.2.1 – Part C

A small, well-insulated, 2-bedroom flat is being designed to have a 3.4kW heat loss at the design internal temperatures and local external temperature. The property is connected to a single-phase electricity supply.

After selecting a 3.5kW heat pump to meet the calculated load, the heat loss calculations are updated because the designer changes the specification of the building fabric (insulation) and windows. The new heat loss for the property is 3.9kW.

The heat pump originally chosen does have a 3kW supplementary electric heater, giving it a total heat output of 6.5kW. However, under the rule in clause 4.2.1 (c), the heat pump should meet at least 100% of the design load at the design temperatures in section 4.2.1 (b) without the inclusion of any supplementary electric heater.

For this reason, a new selection is made for a larger heat pump that has an output of 5.0kW at the local external temperature without use of any supplementary heater.

3rd example of an installation that fulfils Clause 4.2.1 – Part C

A poorly-insulated, terraced house is calculated to have a 6.1kW heat loss using BS EN 12831 at the design internal temperatures and local design external temperature in this document. The property is connected to a single-phase electricity supply.

A 5.4kW heat pump would not meet 100% of the space heating power requirement at the design external temperature and calculated emitter conditions as required by clause 4.2.1 (c), so the ventilation and fabric heat loss have been reduced by upgrading several of the windows and insulating the walls. A number of radiators were also replaced with larger, deeper units to enable the emitter circuit to operate at lower temperatures. With the improvements, the heat loss of the property is reduced to 5.5kW. The lower emitter temperature has also increased the heat pump thermal capacity to 5.7kW (without the use of a supplementary electric heater).

The design now meets the rule in clause 4.2.1 (c) at the design temperatures in section 4.2.1 (b).

Notes on section 4.2.1 – Part E

An example of an installation that fulfils Clause 4.2.1 – Part E

A very large, well-insulated, domestic property is calculated to have a 23kW heat loss at the local CIBSE design temperatures. The property is connected to a single-phase electricity supply.

A heat pump is available that has a 24kW heat output at the local CIBSE external temperature and calculated emitter temperature. However, the Distribution Network Operator (DNO) has said that the existing power supply will not support a further electrical load of this size. The DNO provided a quotation to upgrade their network, but this was excessively expensive in this case.

Instead, a heat pump with a 10.5kW heat output at the local CIBSE external design temperature and calculated emitter temperature has therefore been selected for use with a 24kW oil-fired boiler. In this system, the control system consists of an external thermostat that automatically changes the heat source from the heat pump to the boiler below a certain quoted external ambient temperature.

The heat pump has a 6kW supplementary electric heater but no consideration of this is taken when sizing the system. The heat pump ground collector has been carefully sized to allow for the increased energy extraction associated with this type of heat pump operation, which reflects that the running hours of the 10.5 kW heat pump will be significantly greater than if it had met 100% of the space heating load.

10.1.1. Explanation of Approach to Sizing of Heat Pumps

As the 100% coverage rule for sizing heat pumps refers to a power coverage, not an energy coverage, it is important to distinguish between the two. A heat pump that provides 95% of the heating energy requirement over a year may only be delivering 50% of the space heating power at the lowest outdoor temperatures. Since the strain on the grid is greatest in cold temperatures, it is important to minimise the use of backup electrical heating cassettes. The 100% sizing rule does just this.

In fact, the external temperatures used in MIS 3005 Issue 3.1 are higher than the values that are sometimes used for sizing heating systems. In London, for instance, a more usual design external temperature might be in the region of -4.0°C to -4.6°C , yet the value in the table is -1.8°C . A heat pump required to provide 100% of a building's heat loss based on an external temperature of $\sim -4.6^{\circ}\text{C}$ will be larger than a heat pump required to provide 100% of the heat loss based on an external temperature of -1.8°C , so the 100% rule does **not** require the installation of a system that meets 100% of the **maximum** building heat loss. Given that it is very likely that the temperature in London will drop to $\sim -4.6^{\circ}\text{C}$ for some hours in a year, the actual maximum heat loss that will be experienced is higher than the proposed heat loss value

in MIS 3005 Issue 3.1. There are several other ways of thinking of the clauses proposed in MIS 3005 Issue 3.1:

For a heat pump sized to exactly this rule, the temperatures given in Table 9 are the location of the cross-over point for the space heating load and the heat pump capacity, as shown conceptually in Figure 41. Note that below the cross-over point, the capacity of both types of heat pump and the building heat loss diverge. For a fixed-speed air-source heat pump, the power coverage based on the temperature of the coldest hour, T_c , is approximately 75% (0.75H).

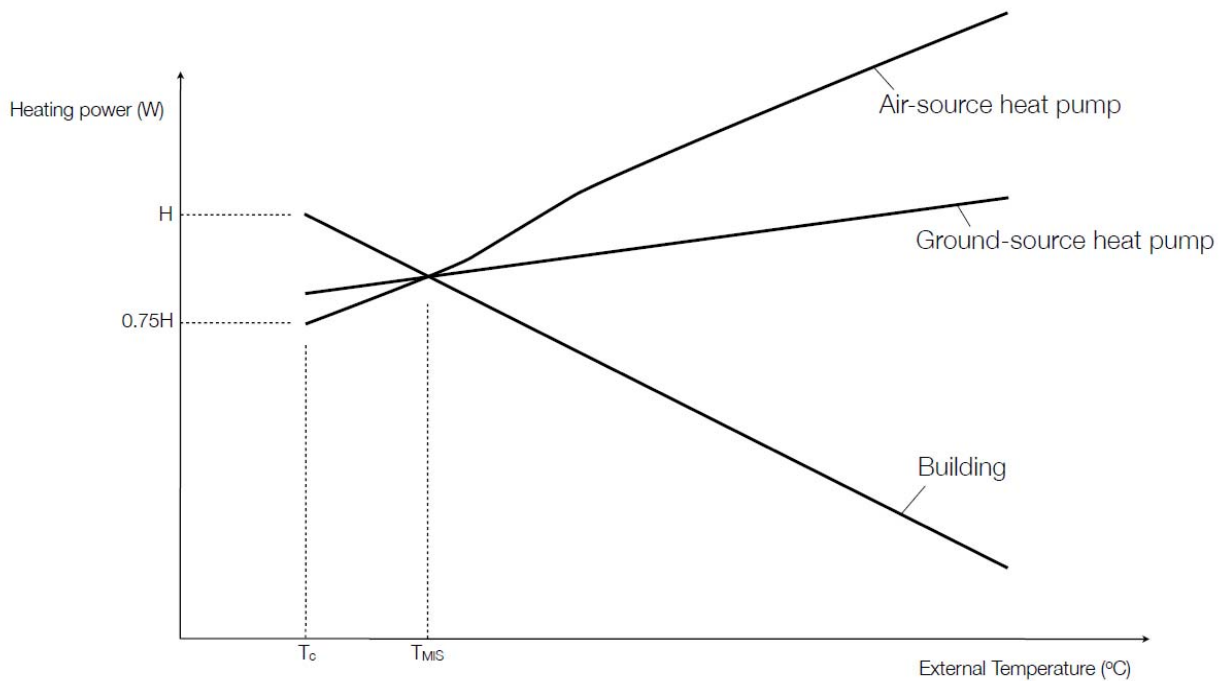

Figure 41: A schematic of heat pump heating capacity and building heat loss for different external temperatures indicating the cross-over point occurs at the temperature defined in MIS 3005 Issue 3.1

For the 1% of the hours (88 hours) that are, in an average year, colder than the temperatures in the table, additional heat sources will be required to maintain the design internal temperature. A schematic of a load duration curve is shown in Figure 42 for the coldest 1,000 hours in the year to illustrate this point. The instantaneous COP is also shown in the figure. It is indicated in the diagram that the power coverage based on the temperature of the coldest hour is approximately 75%.

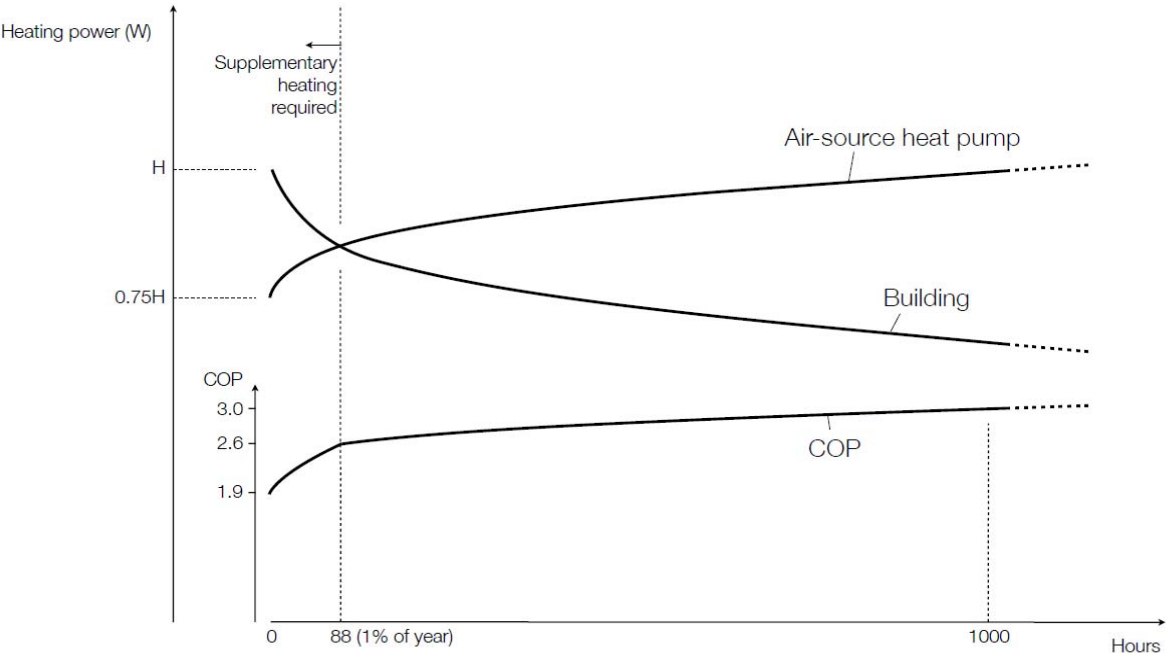

Figure 42: A schematic of a load duration curve for an air-source heat pump

For any period where the external temperature is equal to the values in Table 9, the heat pump will have to be running continuously to maintain the design internal temperature. It will not be possible to heat the building up rapidly (as required for non-continuous heating) or to a higher internal temperature than the design temperature without a supplementary heater. Neither will the heat pump be able to heat hot water because there is no spare heating capacity.

It has been explained that the 100% rule might have been more transparently based on colder temperatures and named the ~75% rule because on the coldest hour a system designed precisely according to the clauses in MIS 3005 Issue 3.1 will only be able to provide ~75% of the building's heat loss. The expert sub-group of specialists that worked on these clauses with DECC and Energy Saving Trust considered that the proposed percentage coverage and external temperature choices would conceptually be easiest to understand and audit. To be understandable, any rule adopted for sizing needed to be simple.

Any estimate of the heat loss of a house is liable to some uncertainty. The effect of this uncertainty on the performance has been considered further in Appendix 4.

10.1.2. Effects of Over- and Under-sizing Heat Pumps on Performance

During the revision of MIS 3005, one heat pump manufacturer in the working group submitted evidence to enable discussions on sizing to move forwards on a numerate basis. For this particular fixed-speed air-source heat pump, seasonal performance factor calculations were run

using the method presented in prEN 14825²² for various building heat losses to cover a range of power and energy coverages by making reasonable assumptions about the building and heat distribution system.

prEN 14825 is able to determine the 'ideal seasonal performance factor' by assuming that the heat pump central heating flow temperature is continually adjusted to match the building heat loss. A variable-speed heat pump tries to achieve this condition. Units with fixed-speed compressors, however, are not able to achieve these ideal conditions and so cycle; this is the basis of the prEN 14825 calculation. Assuming a constant heat emitter circuit volume and emitter surface area, the compressor running hours decrease with increasing heating capacity because of increased cycling. To achieve the same heat output to the building, the heat pump with the fixed-speed compressor must therefore operate with higher central heating flow temperatures while it is running (higher power input to the building) and this is less efficient. The manufacturer submitting the data provided the diagram in Figure 43 to illustrate this point. Increasing the capacity of the heat pump reduces its running hours, which reduces the efficiency if the capacity of the emitter system is unchanged because the average emitter temperature while the heat pump is operating must be increased.

In contrast, reducing the capacity of the heat pump will increase running hours and thereby lower the average central heating flow temperatures required to deliver the same amount of heat, which is proportional to the area of the blocks in Figure 43. Lower central heating flow temperatures improve efficiency.

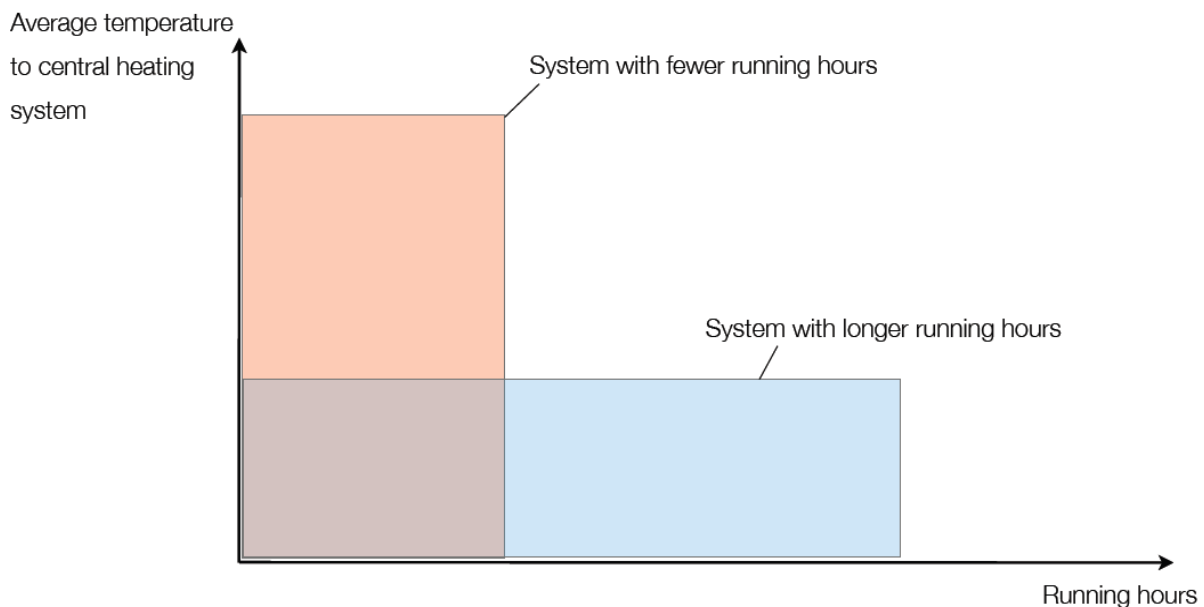

Figure 43: For a constant capacity of heat emitter system, longer running hours enable the same amount of heat to be delivered at a lower temperature

²² prEN 14825 (2010) Air conditioners, liquid chilling packages and heat pumps, with electrically driven compressors, for space heating and cooling — Testing and rating at part load conditions and calculation of seasonal performance

The data submitted can be used to plot the chart of power coverage against annual seasonal performance factor shown in Figure 44. The seasonal performance factor includes all supplementary heaters. For these calculations, it is assumed that the building is in London. Meteonorm²³ was used for weather data. It estimates a -4°C minimum design temperature in London (significantly lower than the CIBSE value in MIS 3005 Issue 3.1). The manufacturer was also able to estimate the power coverage of a system relying on supplementary heating for the coldest 1% of the hours in an average year (88 hours per year) in line with the 100% rule proposed. This is also indicated on the chart by the point at 73% power coverage (earlier this was referred to as ~75%).

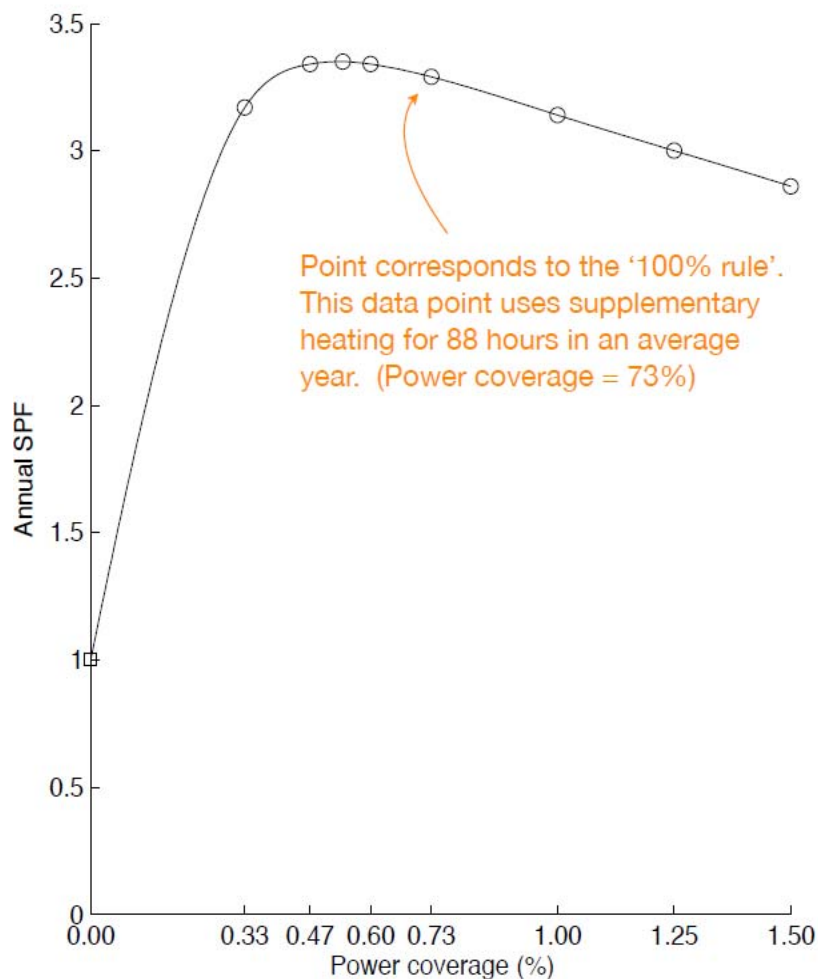

Figure 44: Annual seasonal performance factor as a function of power coverage

The chart shows a slight increase in seasonal performance factor as the power coverage decreases from 100%. However, it is assumed that the system must increasingly rely on supplementary electric heating to meet the building heat loss which is detrimental to efficiency.

²³ <http://meteonorm.com/>

There is, therefore, a maximum in the seasonal performance factor curve, which for this system was calculated to be at ~54% power coverage; 0% power coverage is direct electric heating, which has an seasonal performance factor of 1.

The chart is useful for explaining the arguments for sizing for part load. Some of the heat pumps in the Energy Saving Trust field trial were so under-sized that they resulted in an seasonal performance factor of <2; the refrigerant cycle in these systems must have provided only 10–20% of the building heat loss at the actual design conditions.

The 100% rule does not achieve the highest annual seasonal performance factor for this heat pump but anchors the heat pump conservatively to the right of the maximum, away from the sharp drop-off in performance expected from severe under-sizing. In Appendix 4, the uncertainty of heat loss calculations is examined and it is demonstrated that the clauses in MIS 3005 Issue 3.1 are appropriate for ensuring that under-sizing rarely occurs across a portfolio of installations.

It has been shown that there is a relationship between the relative heating capacity of the heat pump and its annual seasonal performance factor. The relationship is more marked for air-source heat pumps than for ground source heat pumps, whose heating capacities vary less over a year because of their less variable evaporator temperatures and its effects can be alleviated to some degree by using a variable-speed compressor.

10.1.3. Effects of Over- and Under-sizing Heat Pumps on the Grid

It is also possible to estimate the average electricity consumption of a heat pump per unit heat output during the coldest hour. This is shown in Figure 45.

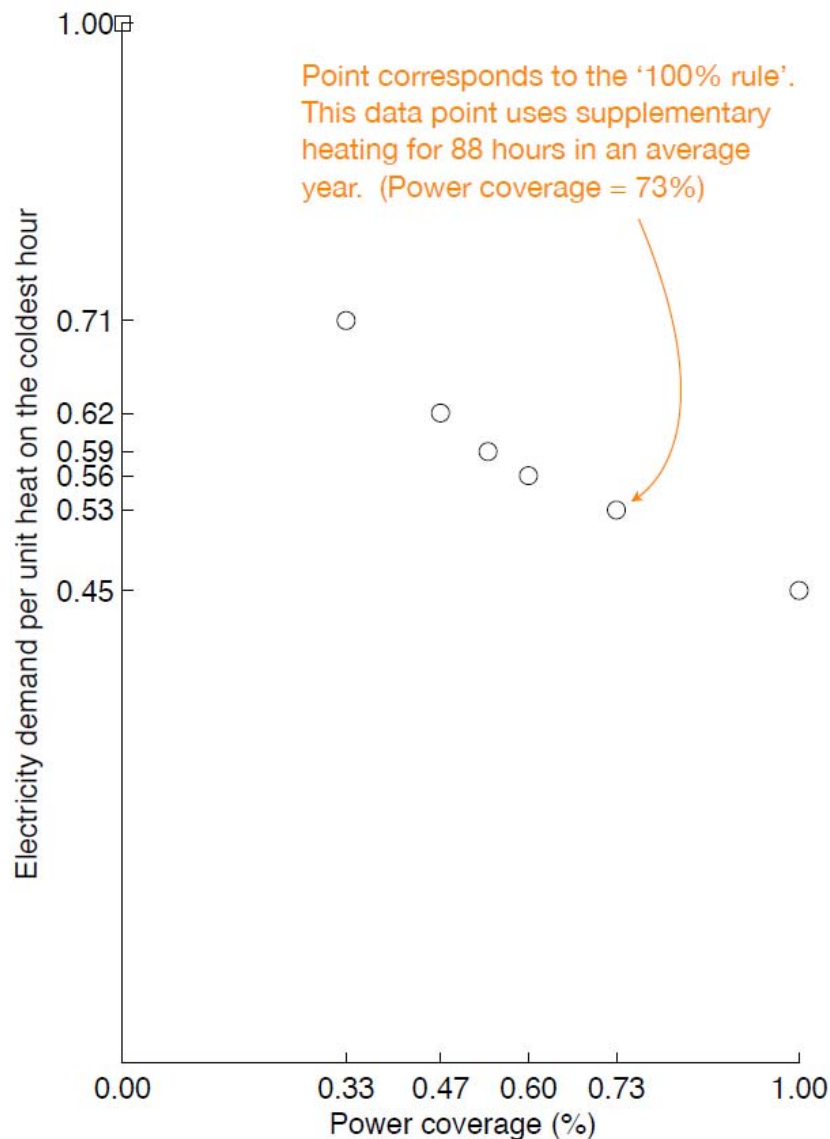

Figure 45: Electricity consumption per unit heat production on the coldest hour. Higher fractions of heat production from electricity will contribute to an earlier requirement to update district electricity cables and an increase in required standby electricity generation in the future.

The maximum electricity consumption of heat pumps will be important in the future energy system according to DECC's modelling for two reasons:

- It is a major contributing factor as to whether or not the electricity cable servicing the local area will require upgrading and how soon that upgrade must happen.
- It is one of the factors that will determine the amount of low load factor, back-up electricity generation that will be required to be added to the system for particularly cold, windless periods.

These will not be discussed in detail in this document but DECC is exploring options for investigating the relationship between heating bills, electricity prices and different sizing methodologies, with and without the inclusion of heat storage (which may be in the building fabric or in a dedicated thermal store).

Qualitatively, sizing a heat pump to greater than 100% of the actual heat loss and combining operation with the use of heat storage will allow the system to be turned off during periods of peak electricity demand and benefit from low (or at least avoid high) electricity prices. Some systems in the Energy Saving Trust field trial successfully did this and were able to take advantage of an Economy 10 tariff. Furthermore, in some European countries, tariffs are already available that require generators to be able to remotely turn heat pumps or their supplementary heaters off at times of peak demand; this requires a degree of over-sizing or alternatively an acceptance that sometimes a building may cool down.

10.1.4. Practical Implications for Sizing Heat Pumps

It is acknowledged that where installers have previously supplied systems in which the heat pump is capable of providing around 50% of the maximum heat loss (on the coldest hour), the installation cost will increase in line with the heat pump capacity. This is particularly true of ground-source heat pumps, for which a higher heating and evaporator capacity requires a larger ground loop. For the same heat distribution system, a higher capacity heat pump will decrease running hours and may increase cycling. This is something installers will want to address. Doing so will reduce the theoretical benefit of part-sizing calculated using the method in prEN 14825. Inverter-controlled heat pumps will be less exposed to the impact of increased cycling.

It is also acknowledged that occasionally a building's estimated heat loss will be only slightly higher than the capacity of one of the heat pumps in a manufacturer's product range. For an installer trying to minimise the heat pump capacity, this may seem unnecessarily prescriptive. However, a line must be drawn somewhere and in the interest of creating a simple, understandable and enforceable installer standard, a tolerance has been intentionally omitted. If a manufacturer's product range does not sit conveniently next to the estimated building heat loss, the installer has the option of recommending to the customer that they further reduce the heat loss of the building before installing the heat pump, or encouraging the householder to increase the capacity of the heat pump by reducing the heat emitter temperature.

10.2. Selection of Heat Emitters

It has been demonstrated that best performance of heat pumps is achieved with lower temperature emitters. Once the heat loss has been calculated according to the procedures set out above, the installer should use the Heat Emitter Guide (published with MIS 3005 Issue 3.1) to discuss the practicality of different types of emitter with the householder.

The current version of the Heat Emitter Guide is reproduced in Appendix 5. It provides estimates of likely space heating seasonal performance factors for ground- and air-source systems, for a given flow temperature. For each flow temperature, a selection of emitter types is given: standard radiators, over-sized radiators, fan assisted radiators and various forms of under-floor heating.

MIS 3005 Issue 3.1 makes the following requirements for the use of the Heat Emitter Guide:

4.2.8 A tool to aid installers and customers to understand the relevance of building heat loss, heat emitter selection and heat emitter temperature on heat pump performance, has been created by the Joint Trade Associations, for use with this document. The Heat Emitter Guide can be downloaded from the following location:

www.microgenerationcertification.org

Installers should make sure they are using the most recent version of the Heat Emitter Guide.

*The heat loss power per square metre (in W/m^2) used to select a table in the Heat Emitter Guide is the **room** heat loss averaged over the **room** floor area, also known as the specific room heat loss. This may be greater than the heat loss of the building determined in section 4.2.1 part c) averaged over the total building floor area.*

4.2.9 At or before the point at which the contract for the works is entered into with the customer, the installer shall, in writing:

- a) Make the customer aware of all specific room heat losses (in W/m^2);*
- b) Identify the type of emitter(s) to be used in the system;*
- c) Make the customer aware of the design emitter temperature based on the worst performing room.*
- d) Agree with the customer the 'Temperature Star Rating' for the design emitter temperature, also making clear the maximum achievable 'Temperature Star Rating'.*

4.2.10 At or before the point at which the contract for the works is entered into with the customer, the installer should:

- a) Show the customer a relevant extract of the Heat Emitter Guide;*
- b) Explain the Heat Emitter Guide, including how it is possible to achieve a higher system seasonal performance factor;*
- c) Explain how the design emitter temperature will be achieved using the type of emitter selected.*

10.3. Design of Ground Loops

The trials have shown several examples of poorly designed ground loops. While there was no clear correlation between under-sized ground loops and performance as measured during the year of the trial, it is clear that under-sizing the ground loop will lead to impaired performance over the long term. With this in mind, the MCS MIS 3005 standard has been modified to include detailed guidance on ground loop design as a function of the heat pump sizing, local weather data and local geology. The modifications are shown below and the appendices are reproduced as Appendices 4-5 of this document:

4.2.11 Designing ground heat exchangers is a complex engineering problem. If insufficient information is available to accurately design a ground heat exchanger, the installer shall adopt a conservative approach. For systems which require the heating capacity found in section 4.2.1 c) to be $\geq 30\text{kW}$ or incorporate ground loop replenishment through cooling or otherwise, the installer should undertake the design process making use of specialist recognised design tools and/or seek advice from an expert.

4.2.12 Manufacturers' in-house software or other commercial software packages (such as EED, GLHEPRO, and GLD) may be used to design the ground heat exchanger provided that the software is validated for UK use and the following parameters are used for each installation:

- a) Site average ground temperatures (or annual average air temperatures). For horizontal ground loops, calculations shall incorporate the swing of ground temperatures through the year at the ground loop design depth.*
- b) Site ground thermal conductivity values (in W/mK), including consideration of the depth of the water table;*
- c) An accurate assessment of heating energy consumption over a year (in kWh) for space heating and domestic hot water for the dwelling as built;*
- d) An accurate assessment of the maximum power extracted from the ground (in kW) (i.e. the heat pump evaporator capacity);*
- e) An accurate assessment of the temperature of the thermal transfer fluid entering the heat pump.*

4.2.13 The temperature of the thermal transfer fluid entering the heat pump shall be designed to be $>0^{\circ}\text{C}$ at all times for 20 years.

4.2.14 Simplified design methods, including look-up tables and nomograms, should only be used where these have been designed and validated for UK ground conditions and installation practices and comply with clauses 4.2.12 and 4.2.13 in this standard.

4.2.15 If proprietary software is not being used, systems with a heating capacity $\leq 30\text{kW}$ that do not incorporate ground loop replenishment through cooling or otherwise shall use the following procedure for each installation for designing the ground heat exchanger.²⁴

a) The total heating energy consumption over a year (in kWh) for space heating and domestic hot water shall be estimated using a suitable method. The calculation shall include appropriate consideration of internal heat gains, heat gains from solar insolation, local external air temperature and the heating pattern used in the building (e.g. continuous, bi-modal, with an Economy10 tariff or otherwise).

b) The total heating energy consumption calculated in section 4.2.15 part a) shall be divided by the heat pump capacity selected in section 4.2.1 part c) to create a parameter called the 'Full Load Equivalent Run Hours' (in hours).

$$\text{FLEQ run hours} = \frac{\text{Total heating consumption}}{\text{Heat pump capacity}}$$

c) The amount of power extracted from the ground is to be limited by the average ground temperature. If a full assessment of the average ground temperature is not being conducted, the annual mean air temperature for the appropriate UK region is provided in the tables and charts and shall be used as the estimate of average ground temperature. The data in the tables and charts are compiled by the MET Office; they are the annual average air temperature measured in a Stephenson Screen at 1.25m. The averaging period is nominally 1981 –2010. See Appendix B²⁵ reproduced here as Appendix 4.

²⁴ This method has been designed to produce a conservative ground array design that should result in the temperature of the thermal transfer fluid entering the heat pump being $>0^{\circ}\text{C}$ at all times in the vast majority of circumstances. Use of improved design input parameters and more sophisticated design techniques may result in a superior outcome.

²⁵ Appendix B of MIS 3005 Issue 3.1 is reproduced here as Appendix 4.

Notes on determining the total heating energy consumption

The Standard Assessment Procedure (SAP) for dwellings is not designed to accurately determine the heating and domestic hot water energy requirements of real dwellings. It assumes a fixed dwelling location and estimates occupancy based on floor area. If SAP is used to estimate the total heating energy consumption over a year for space heating and domestic hot water, it shall be adapted to account for changes in heating energy requirements resulting from the differences in external air temperature. Monthly average external air temperatures are given for various UK regions in Appendix B (reproduced here as Appendix 4).

EN ISO 13790: 'Energy performance of buildings – Calculation of energy use for space heating and cooling' gives a method for the assessment of the annual energy use for space heating and cooling of a residential or non-residential building.

CIBSE Guide A contains comprehensive degree day information for different locations around the UK. Heating degree days can be used in conjunction with EN 12831 and an assessment of the appropriate base temperature to determine a building's heating energy requirement.

The International Ground-Source Heat Pump Association (IGSHPA) provide guidance on determining heating and domestic hot water energy production, electrical energy consumption and running hours using a temperature bin method.

- d) *The local ground thermal conductivity (in W/mK) shall be estimated. The British Geological Survey keep logs from hundreds of thousands of boreholes from all forms of drilling and site investigation work; these can be used to estimate the depth and thermal conductivity of solid geology for closed-loop borehole systems. The British Geological Survey also compiles reports with information on the estimated thermal conductivity of superficial deposits for horizontal loop systems. Experienced geologists and hydro geologists will also be able to estimate the local ground thermal conductivity. For larger systems, it may be beneficial to conduct a thermal response test. The Ground-Source Heat Pump Association 'Closed-loop vertical borehole design, installation and materials standard' contains guidance on thermal response testing. See Appendix C for ranges of thermal conductivity for different rock types.²⁶*
- e) *Using the information established in 2.4.15 parts b) – d), the look-up tables and charts provided for vertical and horizontal systems shall be used to establish the maximum*

²⁶ Note: Appendix C of MIS 3005 Issue 3.1 is reproduced here as Appendix 6.

power to be extracted per unit length of borehole, horizontal or slinky ground heat exchanger. Online versions of these tables are kept on the MCS website www.microgenerationcertification.org. Installers should check for the latest release of these design aids. The ground heat exchanger design shall be compatible with the notes accompanying the tables, for instance concerning the minimum horizontal ground loop or slinky spacing and minimum borehole spacing. For horizontal ground loops, calculations performed to determine the maximum power extracted per unit length have incorporated the swing of ground temperatures through the year.

f) The seasonal performance factor, seasonal performance factor, given in the Heat Emitter Guide at the design emitter temperature should be used to determine the length of ground loop from the specific heat power extraction information found in the look-up tables and charts. The following formula shall be used to estimate the maximum power extracted from the ground (i.e. the heat pump evaporator capacity), G :

$$G = H \left(1 - \frac{1}{SPF} \right)$$

where H is the heat pump heating capacity determined in the section 4.2.1c).

g) The length of the ground heat exchanger active elements, L_b (in m), is determined according to the formula:

$$L_b = \frac{G}{g}$$

where g is the specific heat power extraction from the ground (in W/m) found in the look-up tables. L_b is the length of the borehole heat exchanger; the length of pipe for the horizontal ground heat exchanger; and the length of trench required for the slinky ground heat exchanger.

h) For horizontal and slinky ground heat exchangers, the total ground heat exchanger area, A (in m^2), is determined according the formula:

$$A = L_b d$$

where d is the minimum centre-to-centre spacing of the horizontal or slinky ground heat exchanger specified in the look-up tables and charts.

i) The minimum length of ground heat exchanger pipe in the active elements, L_p (in m), is determined according to the formula:

$$L_p = L_b R_{pt}$$

where R_{pt} is a non-dimensional ratio. $R_{pt} = 2$ for boreholes; $R_{pt} = 1$ for horizontal ground heat exchangers; and R_{pt} is the minimum pipe length to trench length ratio specified in the look-up tables and charts for slinky ground heat exchangers.

j) The installer shall ensure that the flow of thermal transfer fluid is turbulent in the ground heat exchanger active elements. The viscosity of the thermal transfer fluid and therefore Reynolds number, which governs the development of turbulence, changes according to temperature. The Reynolds number of the thermal transfer fluid in the ground heat exchanger active elements should be ≥ 2500 at all times.

4.2.16 For all installations, should the geological situation on drilling or digging show substantial deviation from the conditions used in design or should drilling conditions become unstable or for some other reason the target depth or area not be achieved, the design of the ground heat exchanger shall be recalculated and the installation revised or adjusted if necessary.

4.2.17 For all installations, the installer shall complete and provide the customer with Table 3.²⁷

4.2.18 For all installations, the hydraulic layout of the ground loop system shall be such that the overall system pumping power at the lowest operating temperature is less than 2.5% of the heat pump heating capacity.

Appendix 7 shows an example of a look-up table for vertical ground loops.

²⁷ Reproduced here as Table 10.

Parameter	Value	Comments
Estimate of total heating energy consumption over a year for space heating and domestic hot water	<input type="text"/>	kWh [1] (State calculation method)
HP heating capacity at 0°C ground return temperature and design emitter temperature, H	<input type="text"/>	kW [2]
FLEQ run hours [1]/[2]	<input type="text"/>	hrs [3]
Estimated average ground temperature	<input type="text"/>	°C [4]
Estimated ground thermal conductivity	<input type="text"/>	W/mK [5]
Maximum power to be extracted per unit length of borehole or area of horizontal ground array (from the charts and look-up tables), g	<input type="text"/>	W/m or W/m ² [6]
Assumed heat pump seasonal performance factor (from heat emitter guide)	<input type="text"/>	[7]
Maximum power extracted from the ground (i.e. the heat pump evaporator capacity) $G = [2] * 1000 * (1 - 1/[7])$	<input type="text"/>	W [8]
The length or area of ground heat exchanger calculated using the look-up tables $L = [8]/[6]$	<input type="text"/> (i.e. 2 no. 50m slinkies)	m or m ² [9]
The length or area of ground heat exchanger installed in the ground	<input type="text"/>	m or m ² [10] (NB: state if proprietary software has been used to determine the design length or area)

Table 10: Table 3 from MIS 3005 Issue 3.1: Information to be provided to the customer

10.4. Domestic Hot Water Production and Storage

The Energy Saving Trust trials included one example of a domestic hot water cylinder that was significantly under-sized. As a result, the domestic hot water was stored at a very high temperature, which resulted in poor system performance. Equally, there were examples of households with very low domestic hot water usage, sometimes because they had stand-alone electric showers. In these cases, most of the heat supplied to the hot water cylinder was lost to the remainder of the building. In winter, this heat loss can be considered useful. In summer, it is wasted.

Sections 4.2.3–4.2.5 of MIS 3005 Issue 3.1 cover the sizing of hot water cylinders and make the following recommendations for the control of *Legionella* and other bacteria:

4.2.3 Domestic hot water services design should be based on an accurate assessment of the number and types of points of use and anticipated consumption within the property, making appropriate adjustments for the intended domestic hot water storage temperature and domestic hot water cylinder recovery rate. Additional information for assessing hot water use is available in BS 6700: 'Specification for design, installation, testing and maintenance of services supplying water for domestic use within buildings and their cartilages'; EN 806: 'Specifications for installations inside buildings conveying water for human consumption'; and studies conducted by the Energy Saving Trust and Department of Energy and Climate Change, for example 'Measurement of domestic hot water consumption in dwellings (Energy Monitoring Company) March 2008'.

4.2.4 For domestic hot water cylinder heat exchanger specification, installers should follow the heat pump manufacturers' and/or cylinder manufacturers'/suppliers' recommendations. Domestic hot water heat exchangers for heat pump systems tend to require a much greater heat exchanger performance as compared to combustion-based heat sources. For coil-type heat exchangers, this usually requires a significantly greater heat exchanger area.

4.2.5 Domestic hot water systems shall incorporate a means to prevent bacterial growth (including Legionella bacteria).

NOTE: Further guidance can be found within the Health and Safety Executive Approved Code of Practice L8 document (HSE ACoP L8).

10.5. General Considerations

One house in the Energy Saving Trust trials demonstrated a loss of around 1kW in heat, due to inadequate insulation of pipes and storage cylinders, and poor insulation was observed at a number of other sites.

Analysis of data from the Energy Saving Trust trials has shown a number of sites with high circulation pump usage. In some cases, heat pumps were controlled on central heating return temperature, and, consequently, the circulation pumps were required to be on continuously (throughout the heating season). Possible solutions are to use weather compensation, i.e. to control using the external temperature, or, alternatively, to use a lower circulation pump setting, provided that this is sufficient to pump water around the central heating circuit. Sections 4.2.6 and 4.2.7 of MIS 3005 Issue 3.1 cover these issues:

4.2.6 The contractor shall communicate and explain to the customer the implications of the space heating and domestic hot water system design on the costs associated with providing space heating and domestic hot water to the building, including but not limited to the following considerations:

- *the estimated annual cost of electricity associated with operating the heat pump (this is provided in the estimate of annual energy performance calculated in section 4.3.1)*
- *the electricity costs associated with the operation of collector and emitter circulation pumps, particularly if these are intended to be operated on a continuous basis*
- *heat losses associated with storage vessels*
- *the electricity costs associated with domestic hot water that may have been produced with an immersion element or supplementary electric heater.*

4.2.7 All space heating and domestic hot water installations must comply with local building regulations and standards e.g. Part L in England & Wales and Section 6 in Scotland. The Domestic Building Services Compliance Guide, where applicable, provides further advice on compliance including cylinder and pipe insulation sizing.

11. Future Work

11.1. Second Year of the Energy Saving Trust Heat Pump Field Trials

Following the analysis described above, it was decided to make a range of interventions on some of the heat pumps in the trial. These include:

- replacing heat pumps with smaller or larger units
- increasing the size of radiators
- changing control strategies and reducing flow temperatures
- extending one ground loop
- replacing the existing circulation pumps with more efficient ones
- replacing hot water cylinders with smaller ones where appropriate
- insulating pipe and cylinder work.

Around 40 sites will be analysed for a further year, and the results will be reported by the Energy Saving Trust.

11.2. Other Heat Pump Monitoring Projects

The Energy Saving Trust field trials represent the largest publicly available study of domestic heat pumps in the UK to date. However, these trials are not definitive. In particular, the heat pumps in the trial were installed prior to the development of MIS 3005 Issue 1.0. As part of the Renewable Heat Premium Payment Scheme, DECC is undertaking the monitoring of at least 100 domestic heat pumps installed under this programme. All will be installed by MCS installers, some to MIS 3005 Issue 2.0 and others to MIS 3005 Issue 3.1. We are also aware that several manufacturers are undertaking studies on their own heat pump installations privately.

The field trials did not investigate the question of warm-up times, or the question of whether heat demand increases if under-floor heating is used (because of the high thermal mass of the concrete). There is also scope for a wider investigation of the actual change in energy use when 24-hour heating is used (as opposed to the modelled change). Such a study should examine the extent of thermal bridging between the floor and the walls for under-floor heating systems.

There is a need to develop simple tools to make sizing a heat pump easier. A robust tool that would use the building heat loss, emitter size, heat pump characteristics and local weather data to produce estimates of seasonal performance factor would be helpful.

The combination of heat pumps and heat storage is of great strategic interest, since it has potential to limit the likely increase in the peak electrical demand on the grid. DECC is currently drawing up a specification for demonstration projects in this area. Furthermore, the Engineering and Physical Sciences Research Council is running a 'grand challenge' programme on energy storage, including heat storage.

APPENDIX 1: INSTRUMENTATION USED

The monitoring and data-logging equipment installed in each house was specified in the Energy Saving Trust's technical monitoring specification, and generally consisted of the following:

- Generation II radio telemetry wireless data logger (where possible shared between two houses), with associated:
 - GSM modem
 - SIM card
- electric meters on:
 - electricity supply to heat pump
 - immersion heater in the domestic hot water cylinder
 - sink/circulation pump
- heat meters for:
 - space heating
 - domestic hot water (heat and flow rate)
- additional heat meters (explained above) installed at some sites:
 - a ground loop heat meter at a few sites with accessible ground source loops (to enable heat balances to be undertaken)
 - a heat meter measuring the heat output as close to the heat pump as possible – this is a particularly important meter for most air-source heat pumps, as it measures both the energy produced by the heat pump and the energy removed from the property to facilitate the defrost cycle (in the case of those heat pumps that use a reverse heat pump cycle to provide the defrost)
 - a heat meter measuring heat into the domestic hot water cylinder at a few of those sites that use standard (remote) domestic hot water cylinders heated by hot water coils
 - heat meters on additional heat sources and sinks (for example, systems with both under-floor heating and radiators)
 - a heat meter measuring the energy lost from continuously pumped domestic hot water supplies (this was only the case at a few of the larger properties with long pipe-runs between the domestic hot water cylinder and the taps)
- three wireless, single-point temperature transmitters:
 - external ambient (on the north side of the property)
 - living room
 - upstairs (main bedroom)

- wireless, multi-point temperature transmitters, with sensors strapped to pipework, measuring temperatures on:
 - flow and return pipes on the sink at all sites
 - flow and return pipes on the central heating at all sites
 - flow and return pipes on the ground source, or two air off temperatures on the air source, at all sites
 - domestic hot water temperatures: cold feed, hot water out and cylinder temperature where the heat pump supplies domestic hot water
 - ground temperature sensors, where drilling could be carried out safely, the instrumentation would remain undisturbed and the positioning of the ground source loop was known
- wireless pulse counting transmitters collecting the outputs from:
 - electricity meters
 - heat meters.

All meters were purchased new for this project and are of high quality. Heat meters are manufactured to the EN 1434 standard and sold as a complete legal entity.



Figure 46: Generation II wireless data logger and transmitters

Checks were carried out on one of each type of heat meter used in the project (UH50, Sontex and Metrima), comparing the heat meter performance against an electrical flow boiler, with the electricity consumption metered using one of the trial electricity meters. Agreement was between 98% and 100% in all cases (that is, the heat meter reading was less than the electricity meter reading – probably due to small heat losses from the flow boiler in the test rig).

On previous comparable field trial projects, calibration certificates for the heat meters were obtained from the manufacturer. These calibration certificates show that the heat meter manufacturers select matched pairs of temperature probes for each meter, with errors of between 0.1°C and 0.3°C at a flow and return temperature difference of 10°C (from a sample of 120 meters). Larger percentage errors are possible at lower temperature differences, but this will only significantly affect ground loop heat meters; these are used only for heat balances (see Appendix 2), and the heat balances obtained are good. Accuracies are always significantly better than those required by EN 1434. This requires maximum permissible error to be less than +/-5%.

Heat meters have been shown to give erratic, erroneous readings when air (or another gas) is present in the circulating water flows. A SpiroVent – a particular brand of in-line de-aerator – was fitted as a preventive measure to sites where it was considered likely that a heat meter might experience air within the water flow, and where no other type of de-aerator had already been fitted. SpiroVents were also retrofitted to a few sites that experienced erratic heat meter readings after the start of the trial. Where SpiroVents were installed, they were located in the flow from the heat pump, at the highest point in a circuit. Further details of the monitoring equipment are shown in Table 11.

Measurement	Meter	Sensor resolution	Accuracy
Heat meter	Landis and Gyr UH50	0.1kWh and 0.01kWh	Typically $\pm 2.5\%$
Bi-directional heat meter	Metrima F27HC	100Wh	Class 2
Electric meters	Class 1 manufactured; Class 2 Ofgem approved	1Wh	$\pm 2\%$
Pipe temperatures	Eltek	0.1°C	$\pm 0.3^\circ\text{C}$
Room and ambient temperatures	Eltek	0.1°C	$\pm 0.3^\circ\text{C}$

Table 11: Accuracy and resolution of instrumentation

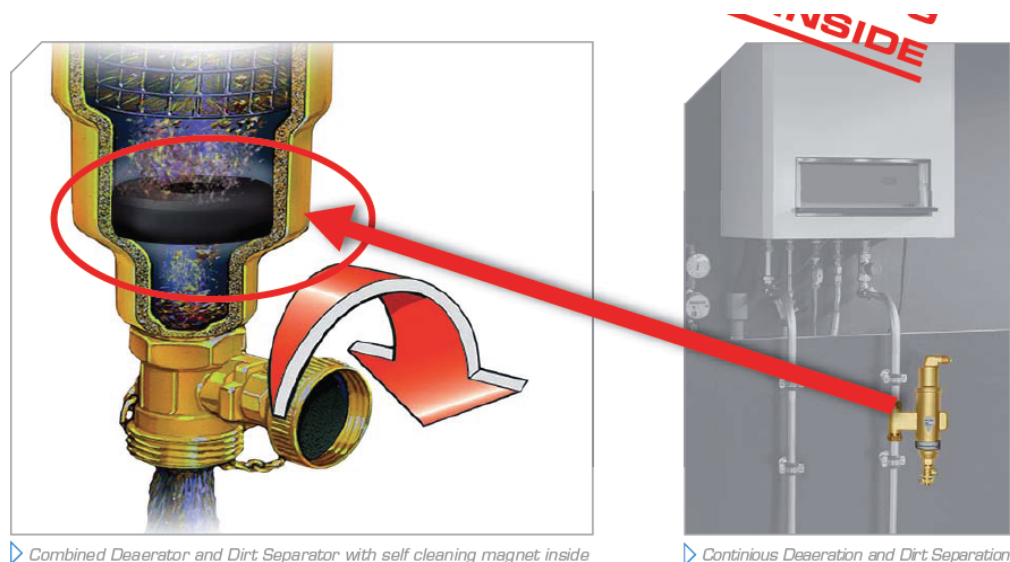

Figure 47: SpiroVent de-aerator

At temperature differences below the lower limit of 3°C, the manufacturer of the Landis and Gyr heat meter is unable to guarantee that the error remains within the EN 1434 standard; however, the meter still operates and records data when the temperature difference is less than this. The primary issue is the error on the platinum resistance thermometer (PRT) when measuring small temperature differences at relatively low temperatures. This would be an issue for any monitoring system using PRTs and a flow sensor. The advantage of using a heat meter is that the probes are a matched pair and are calibrated for the integrator unit. This helps to minimise errors. A possible alternative, the very high accuracy 1/10 DIN PRT, is generally only used within the laboratory environment because of high cost. The data monitoring team agreed before the trial that the combined heat meter solution would produce results at least equivalent to a system made up of separate temperature and flow sensors.

The equipment fitted on each site was determined on a site-by-site basis, dependent on the type of appliance installed and the configuration of the system.

Although the original monitoring specification required data to be recorded once every 10 minutes, the data logging interval was set to 5 minutes throughout this trial to give greater compatibility of results with other trials undertaken by the Energy Saving Trust (including micro-wind, condensing boilers and solar water heating).

APPENDIX 2: PROCEDURES FOR DATA CHECKING

EA Technology collected the 5-minute data from individual data loggers remotely via the GSM mobile phone network and stored the raw data in a database. These raw data were automatically checked for erroneous figures, 'no data' errors or major collection errors. Spurious readings were checked manually, and where it was clear that the reading was spurious, they were removed. A log is kept of such substitutions. The spurious readings were rare, and were generally caused by either corruption during the download process or the pulse counter within an individual pulse-counting transmitter reaching saturation (2^{16}) and resetting to zero.

Data received by Gastec at CRE were processed automatically using a program written in VB Excel. This program aggregated the weekly data into monthly spreadsheets, with a separate sheet for each day, and added calculations relevant to the specific site and type of appliance installed. This enabled the whole month to be inspected visually in a summary page.

Specifically, the power in and heat out were summed up over the day and then month. On sites where the total heat output from the heat pump was measured, the heat pump seasonal performance factor (SPF) was calculated. The buffer cylinder and domestic hot water cylinder efficiencies were calculated, along with apparent system efficiency. This allowed for a quick visual inspection of the data and it was easy to spot any discrepancies between days. The degree day heating requirement was calculated from the ambient temperature and was used to check the heat supplied to the house against the heat demand of the house.

The dataset was processed weekly, as required by the technical monitoring specification, so that high level problems, such as an inability to contact a data logger or data errors within a logger, could be addressed quickly. The data were compared with previous months on a monthly basis as a further quality check. Inter-house checks were also made. Gastec at CRE excluded erroneous data for the time stamp where the pulses lay outside the expected range.

On discovery of inconsistencies in data, missing temperature data channels are easily identified. However, missing pulse data channels are more difficult to recognise since they may show a value of zero, both during normal operation and when the channel output has a fault. Thus, if discrepancies were found in the efficiencies and inter-day comparisons, the 5-minute data were studied in detail to establish where the fault lay.

As faults were identified on sites, they were reported to the project managers at Gastec at CRE and EA Technology. Problems of missing data were usually caused by transmitter batteries failing or by water damage to transmitters. This generally required a site visit to correct the fault, although householders at a few sites were taught to replace batteries themselves. Problems such as not being able to contact a site were given top priority and were generally solved by the householder resetting the data logger. All faults were logged.

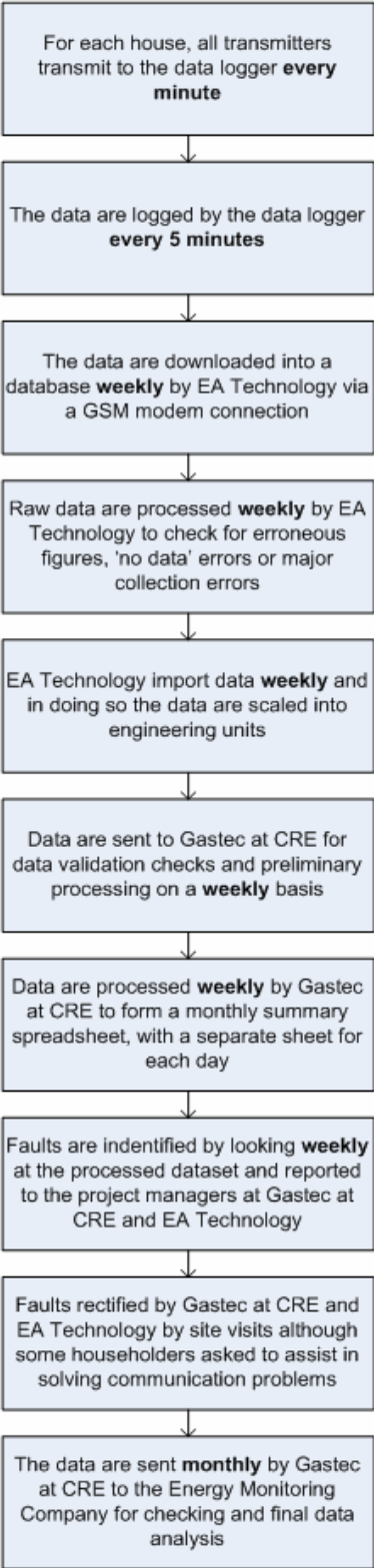

Figure 48: Flow chart showing procedures for data checking

Pre-analysis Data Checks

Before the incoming data were assembled into a master file for each dwelling, a number of rudimentary checks were carried out. These centred on checking that each value was within a given range, and also that the rates of change were reasonable.

These checks are very simple, but their strength is that they are applied automatically – **every single data value is checked**. The number of points rejected is small, but a single rogue point could significantly affect subsequent analysis. Although it is simple, this stage in the data validation process is invaluable. The process detected a relatively small number of suspect data points beyond those already detected by the Gastec at CRE checking process described above, and these were duly removed from the dataset.

Consistency Checks on Heat Meters

Heat meters of the type used in this project are more commonly used to measure the outputs of boiler systems, where the differences between flow and return temperatures are rather larger than those from heat pumps. As a result the manufacturer guarantees their accuracy for billing purposes only down to a temperature difference of 3°C. In some of the heat pump installations, temperature differences are smaller than this. This is particularly the case for the meters used to measure the energy coming from a ground loop. It was thus important to ensure that the heat meters used work reliably at these lower temperature drops.

Heat from the ground loop was measured in only a small number of cases (the energy balance sites described above). However, ground loop flow and return temperatures were measured in all cases, and this provides the basis for a check on the performance of the heat meters. If the flow in the ground loop is essentially constant then the heat delivered will be proportional to the difference between the flow and return temperatures. Thus, a plot of recorded heat output against temperature difference should be a straight line, passing through the origin.

For periods when the pump runs constantly the flow rate will vary only slightly with temperature, as the density and viscosity of the brine change. However, it is important to consider only those periods when the circulation pump ran continuously, otherwise the average flow will be reduced. Figure 49 was generated from data averaged over periods when the heat pump (and hence the circulation pump) ran continuously.

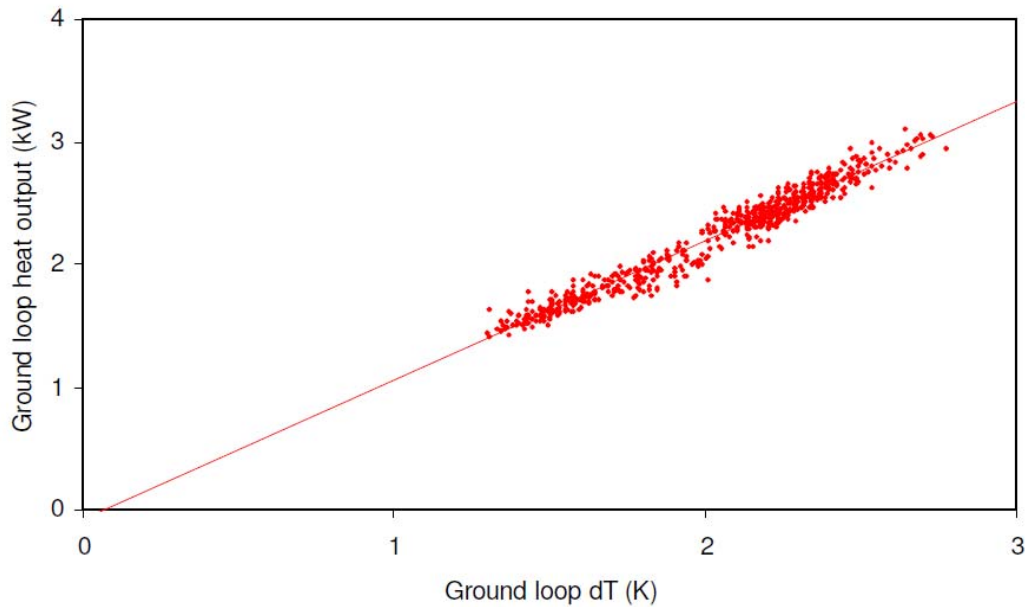

Figure 49: Consistency check on operation of heat meters at low temperature drops

The figure confirms that the response of the meters is linear down to the smallest temperature difference observed – here about 1.3°C. It is concluded that the meter can produce reliable data down to the smallest temperature differences encountered.

Consistency Checks on Hot Water Temperature Measurements

At all sites where the heat pump is used for hot water production, the hot water temperature is measured in the pipe leaving the storage cylinder. During periods when no water is being used, the reading of this sensor will fall as the water surrounding it cools in the pipe.

The most obvious way of determining the actual temperature at which hot water is being made available is to use the readings from the sensor only when there is a run-off occurring. However, this approach may result in under-reading during very short run-offs. To evaluate the impact of this effect, and to make a decision about the best way to generate hot water data, a comparison was made between the approach described and two other methods of obtaining the information.

In some dwellings a further sensor has been used to measure the temperature of the water within the storage cylinder, and this provides the first way of obtaining an alternative measure of hot water temperature. The heat delivered as hot water is metered, as is the volume used. Taken together with the cold feed temperature, this provides another way of estimating delivery temperature. The measurement of the temperature of the incoming cold water is also subject to errors when there is no run-off, as the sensor temperature falls or rises. The estimate of cold water temperature

must therefore be made in the same way as described for hot water, but because the actual value is closer to ambient temperature any errors will be considerably smaller. Figure 50 shows daily estimates of hot water temperature using all three of the measurement methods described.

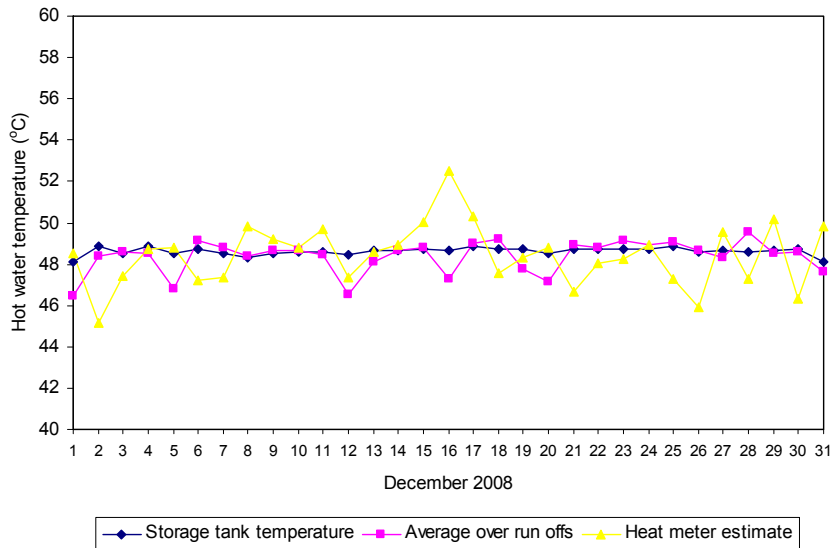

Figure 50: Alternative estimates of hot water temperature

The figure demonstrates that all three methods give results that are approximately the same. As expected, the direct measurement of cylinder temperature gives the most stable estimate but, as explained, this measurement is not available in all dwellings. The use of the heat meter provides an estimate that is weighted by flow, since run-offs at low flows contribute less to the average. However, as the figure shows, it is prone to more fluctuation. This is most likely due to the resolution of the heat meter, which for days with small run-offs may become a significant source of noise. In view of these observations, the method of averaging over run-offs has been chosen as the most direct and reliable approach.

Consistency Checks on Analysed Data

The final type of check carried out on the data is based on some preliminary analysis. Figure 51 shows a plot of the daily heat output of a sample heat pump against the electrical input. This type of plot appears throughout the analysis presented in this report, and we refer to it as an EQ-plot.

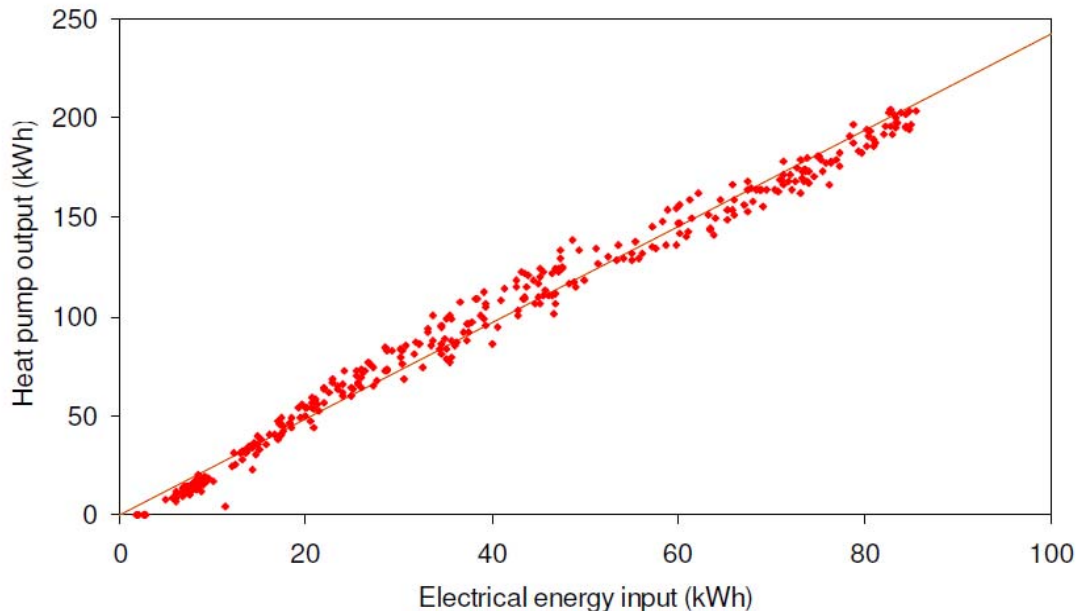

Figure 51: Heat output as a function of electrical energy input (the EQ-plot)

As expected, there is a strong linear relationship between the two quantities, heat output and electric input (both measured in kWh). The quality of this relationship can be expressed as a correlation coefficient. A value of zero would indicate no relationship between electricity input and heat output; a value of 1 would indicate a perfect straight-line fit (although not necessarily passing through the origin). The correlation coefficient for the data shown in Figure 51 is 0.993. When weekly data are examined, the effects of the dynamics associated with thermal storage are reduced, and correlation coefficients further improve.

The line shown in the figure has a slope obtained by dividing the total heat output of the system throughout the heating season by the total electrical input over the same period. It is not a conventional regression line (even if that regression was forced to go through the origin). It is also important to observe that the slope of the line, or overall efficiency, is not equal to the average of the efficiency on each day. Calculating the overall efficiency in this way would give equal weighting to each day, regardless of how much energy was actually produced on that day.

One way of interpreting this plot is to consider each point as a one-day test of the efficiency of the heat pump. The figure indicates that if this is done every day of the heating season then the values obtained each day will be very similar: in other words, that the data are highly consistent. The fact that such tight correlations are routinely found further builds confidence in the quality of the data being gathered.

Plotting heat output as a function of electrical energy input has proved central not only to the analysis of heat pump data, but also to the process of weeding out periods of invalid data. Periods where electricity meter readings are lost are immediately obvious as points which lie on the y-axis. Similarly, points where heat meter data are missing appear on the x-axis. More subtle effects, such as a heat meter reading becoming unreliable, appear as points away from the main coefficient of performance (COP) line. While this allows a further cleaning of the data, it is also important to remember that a poor correlation does not necessarily indicate poor data: it could be due to a real effect, such as poor control of the heat pump. In all cases it is essential to check that data really are suspect before they are removed. Obviously it is not possible to know the impact that the lost data might have had on calculated system performance, but the high degree of consistency implied by the plot implies that this will be small.

When the final stage of the data-cleaning and validation process is complete, it is of interest to look at the EQ-plot correlation coefficients obtained across the whole sample. Figure 52 shows the distribution of these coefficients.

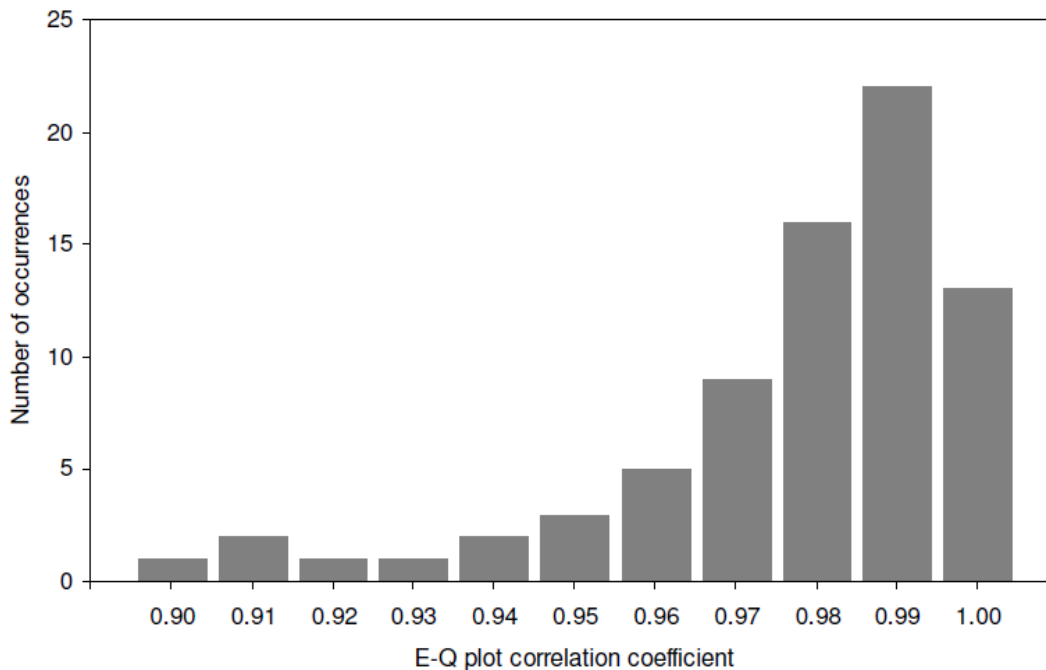

Figure 52: Distribution of EQ-plot correlation coefficients

In addition to the results shown in Figure 52, there are three sites with much lower coefficients, in the range 0.7–0.9. In each of these cases the data have been carefully checked to ensure that they are valid and that the poor correlations are due to erratic operation of the heat pumps themselves.

APPENDIX 3: APPENDIX B FROM THE REVISED MIS 3005 STANDARDS: MET OFFICE DATA 1981–2010

Table 12: Met Office mean monthly and annual air temperatures (°C) for selected stations based on the long-term averaging period 1981–2010

Region	Mean monthly and annual air temperature /°C (1981-2010)												
	Jan	Feb	Mar	Apr	May	Jun	Jul	Aug	Sep	Oct	Nov	Dec	Annual
NE Scotland (Dyce)	3.5	3.8	5.3	7.2	9.6	12.4	14.6	14.4	12.2	9.1	5.9	3.6	8.5
NW Scotland (Stornoway)	4.8	4.7	5.6	7.1	9.3	11.5	13.4	13.5	11.8	9.3	6.8	5.1	8.6
E Scotland (Leuchars)	3.6	4.0	5.7	7.5	10.0	12.9	15.0	14.8	12.7	9.5	6.1	3.6	8.8
Borders (Boulmer)	4.4	4.5	5.9	7.4	9.8	12.6	14.7	14.8	12.9	10.1	6.9	4.6	9.0
W Scotland (Abbotsinch)	4.0	4.2	5.9	8.0	10.9	13.5	15.4	15.0	12.6	9.4	6.2	3.8	9.1
N Ireland (Aldergrove)	4.4	4.5	6.2	8.1	10.9	13.5	15.4	15.0	13.0	9.9	6.8	4.7	9.4
North-eastern (Leeming)	3.8	4.1	6.1	8.1	11.0	13.9	16.2	15.9	13.5	10.0	6.5	3.9	9.4
North-western (Carlisle)	4.3	4.5	6.2	8.2	11.1	13.7	15.7	15.4	13.2	10.1	6.8	4.2	9.4
Midlands (Elmdon)	4.1	4.1	6.4	8.4	11.5	14.5	16.8	16.5	13.9	10.3	6.7	4.2	9.8
Wales (Aberporth)	5.3	5.1	6.6	8.2	10.9	13.4	15.2	15.3	13.7	11.0	8.0	5.9	9.9
E Pennines (Finningley)	4.2	4.4	6.6	8.6	11.7	14.6	16.9	16.8	14.2	10.6	6.9	4.4	10.0
W Pennines (Ringway)	4.5	4.6	6.6	8.7	11.9	14.5	16.6	16.3	14.0	10.6	7.1	4.6	10.0
East Anglia (Honington)	4.1	4.1	6.5	8.6	11.9	14.8	17.3	17.2	14.6	11.0	7.0	4.4	10.1
South-eastern (Gatwick)	4.3	4.4	6.7	8.7	12.0	14.9	17.3	17.0	14.3	10.9	7.1	4.6	10.2
Southern (Hurn)	4.9	4.9	6.8	8.7	12.1	14.8	17.0	16.8	14.4	11.2	7.6	5.2	10.4
Severn Valley (Filton)	5.0	5.0	7.2	9.2	12.4	15.3	17.3	17.1	14.7	11.3	7.8	5.3	10.6
South-western (Plymouth)	6.4	6.2	7.7	9.3	12.2	14.6	16.6	16.7	14.8	12.1	9.0	7.0	11.0
Thames Valley (Heathrow)	5.2	5.2	7.6	9.9	13.3	16.4	18.7	18.4	15.6	12.0	8.0	5.5	11.3

Notes:

- 1) All values are provisional
- 2) Monthly station data are included where the number of missing days each month is 2 or fewer. For months with more than 2 missing days, estimated monthly values are taken from the monthly mean temperature grid for that particular month. The long-term average is therefore based on the combination of monthly station data where there are 2 or fewer missing days, and monthly grid estimates, for more than 2 missing days. The method used to produce the monthly gridded datasets is described in Perry MC and Hollis DM 2005, The generation of monthly gridded datasets for a range of climatic variables over the UK, Int. J. Climatology. 25: 1041-1054 and available here: http://www.metoffice.gov.uk/climate/uk/about/Monthly_gridded_datasets_UK.pdf

Table 13 below lists the number of missing months for each station (with more than 2 missing days) where grid estimates are used. This table appears as Table B1 in Appendix B of MIS 3005 Issue 3.1.

Table 13: List of missing data from Met Office stations used to establish mean temperatures in Table 12

Station	Comments
NE Scotland (Dyce)	Complete record
NW Scotland (Stornoway)	Complete record
E Scotland (Leuchars)	Complete record
Borders (Boulmer)	Complete record
W Scotland (Abbotsinch)	Missing from May 1999 to December 2010
N Ireland (Aldergrove)	Complete record
North-eastern (Leeming)	Complete record
North-western (Carlisle)	Several months missing between 1994 and 2001 inclusive
Midlands (Elmdon)	Missing from April 1999
Wales (Aberporth)	Complete record
E Pennines (Finningley)	Missing from October 1995 to December 2010
W Pennines (Ringway)	Missing from November 2004 to December 2010
East Anglia (Honington)	Missing from October 1992 to July 1997 and April 2003 to December 2010
South-eastern (Gatwick)	Missing from January 1981 to March 2003
Southern (Hurn)	Complete record
Severn Valley (Filton)	Missing from January 1981 to February 2001
South-western (Plymouth)	Several months missing between 1995 and 2000
Thames Valley (Heathrow)	Complete record

These data are reproduced with permission from the Met Office National Climate Information Centre.

APPENDIX 4: EFFECT OF UNCERTAINTY IN BUILDING HEAT LOSS CALCULATIONS ON SIZING OF HEAT PUMPS

When looking at the power coverage resulting in the maximum annual seasonal performance factor, it has so far been assumed that the building heat loss is known accurately. Of course this is never the case. A number of factors can result in an incorrect estimate of building heat loss:

- The building fabric heat loss coefficient may be inaccurate because the assessor did not measure or investigate the building rigorously; a new-build property has not been built according to plan; cavity walls that are assumed filled are, in fact, partially filled; a floor slab with under-floor heating is un-insulated around the sides and increases thermal bridging; or other sources of thermal bridging are present.
- Ventilation losses are affected by householders who prefer to sleep with a window open, or by householders who leave doors or French windows open in order to allow access to the garden in winter.
- The householders may prefer higher thermostat settings than the average; for example, elderly householders may require more heat.

Figure 53 demonstrates the effects of under-estimating and over-estimating the building heat loss.

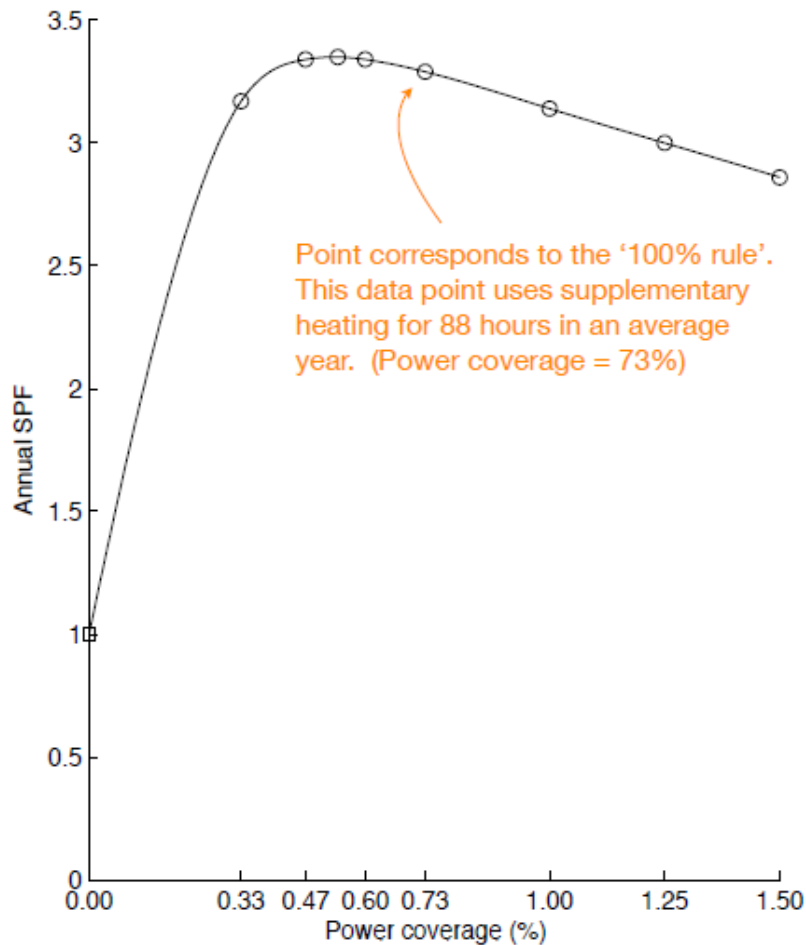

Figure 53: The calculated relationship between power coverage and annual seasonal performance factor

The figure demonstrates that if the heat pump is sized to coincide with the maximum seasonal performance factor in the figure, the penalty of being under-sized is more severe than the penalty of being over-sized.

It is possible to perform a calculation to estimate the impact of heat loss estimation uncertainty on sizing using reasonable assumptions about the distribution of actual maximum heat loss compared with the value used in design.

Convolution is a mathematical operation that can be used to do this. It is the integral of the products of the two functions: in this analysis the seasonal performance factor curve and a probability distribution. It creates a weighted average representative of a large number of installations with uncertain actual heat loss. The charts in Figure 54 show the impact of performing convolutions of (convolving) the seasonal performance factor curve with different normal and square distributions.

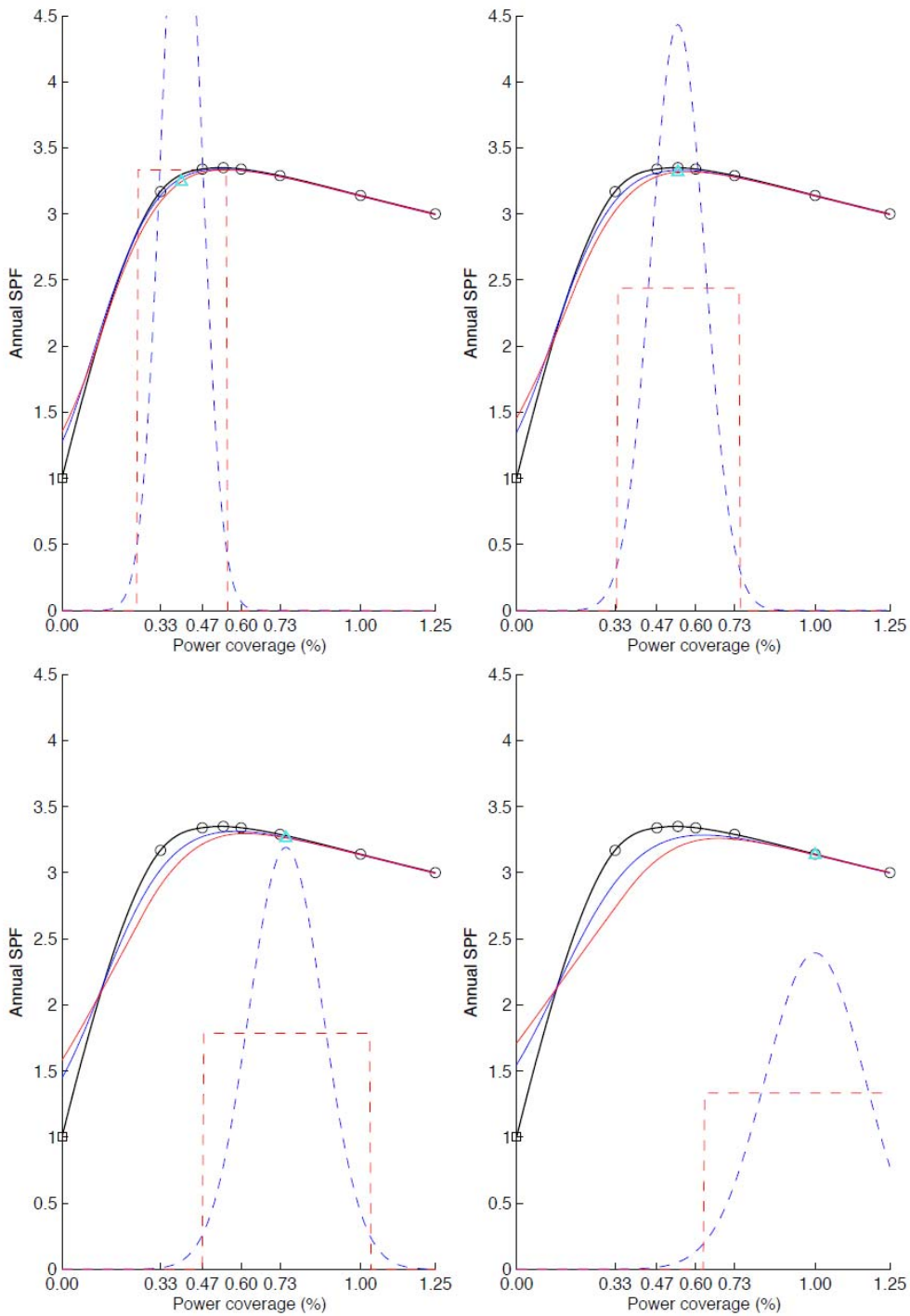

Figure 54: Investigation of the effect of error in heat loss on estimated required capacity of the heat pump

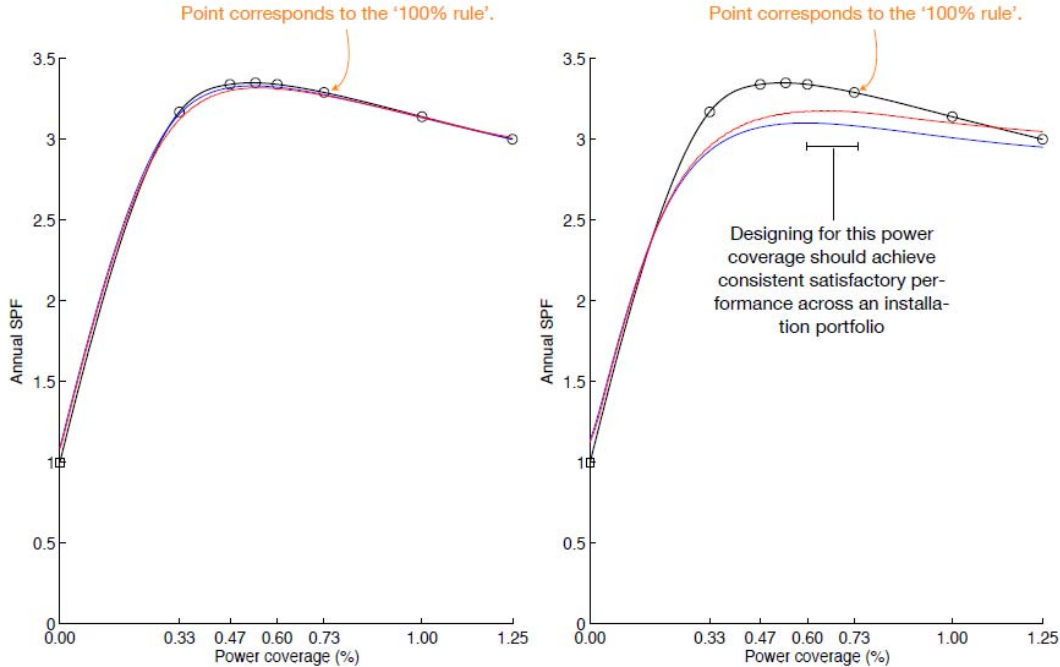

Figure 54 (continued): Investigation of the effect of error in heat loss on estimated required capacity of the heat pump

When considering a large sample of installations, the weighted average of seasonal performance factors for all the installations – the red and blue lines – will be lower than the theoretical value achievable, had the design heat loss been known precisely. This will always be the case if the rate of change of the gradient (the second derivative) of the seasonal performance factor function is negative, as is the case in the area of interest on the fixed-speed air-source heat pump seasonal performance factor curve. To explain this further, consider an installation whose building heat loss has been under-estimated. The actual seasonal performance factor achieved will be at a different point on the curve to that which the designer anticipated. On other occasions, the heat loss may have been over-estimated, corresponding to a different point on the seasonal performance factor curve again. The red and blue lines show weighted averages of all of those occasions. If intending to size a heat pump installation close to the maximum on the black (calculated) seasonal performance factor curve, it must be accepted that the seasonal performance factor will sometimes fall off the maximum to the left, corresponding to under-estimation of heat loss; and other times to the right, corresponding to over-estimation of heat loss. Because of the skew in the relationship between seasonal performance factor and power coverage for this fixed-speed air-source heat pump, a higher average seasonal performance factor will be achieved over a large number of systems if the designer aims for a power coverage to the right of the maximum.

In Figure 54, curves are plotted showing this effect assuming $\pm 25\%$ and $\pm 50\%$ uncertainty in the heat loss estimate. For the normal distribution, it is assumed that about 95% of the actual building heat loss values are within the percentage given (2 standard deviations). Whether $\pm 25\%$ and $\pm 50\%$ are reasonable can be debated.

It is shown that the impact of considering building heat loss uncertainty in this way is to shift the maximum of the 'multi-system-average seasonal performance factor curves', shown in red and blue, to higher power coverages than where the original curve was when it was assumed that the building heat loss was known precisely. The effect is reasonably small if the uncertainty in the heat loss calculation is $\pm 25\%$ but significant for $\pm 50\%$ uncertainty. The maximum multi-system-average seasonal performance factor for the latter is close to the 73% power coverage point corresponding to the '100% rule' (for the air-source heat pump with fixed emitter circuit volume and area).

The effect is shown for normal and square distributions because these are trivial to generate, but they are not necessarily a good choice. Many of the reasons for heat loss calculation uncertainty outlined in the previous section would result in under-estimation of the heat loss rather than over-estimation, so perhaps a more sensible distribution to use in the convolution calculation would be one that is skewed towards under-estimation of power coverage. The limited data available comparing measured and actual heat loss also show that heat losses are rarely over-estimated. Another sensible weighting would be based on customer complaints, which would be heavily weighted towards points with low seasonal performance factors (lower power coverages). Qualitatively, it can be seen that these would move the maximum of the multi-system-average seasonal performance factor curve to higher power coverages than those produced by the normal and square distributions.

Considering the $\pm 50\%$ uncertainty chart in Figure 54 and this qualitative consideration of complaints, it is suggested the '100% rule' is appropriate if the major goal of this revised MIS 3005 standard is to achieve consistent acceptable performance. Indeed, there are several examples of systems in the Energy Saving Trust field trial sized for more than 100% power coverage which achieve exactly this.

APPENDIX 5: HEAT EMITTER GUIDE

Trade Associations representing heat pump and heat distribution technologies produced a heat emitter guide for domestic heat pumps. DECC, the Microgeneration Certification Scheme and the Energy Saving Trust supported the guide. It is available at www.microgenerationcertification.org/installers/installers.

APPENDIX 6: APPENDIX C FROM MIS 3005 ISSUE 3.1: VALUES FOR THERMAL CONDUCTIVITY OF DIFFERENT TYPES OF ROCK

Table 14 (below) and Figure 55 (below) are produced from VDI 4640: 2010. This information is also available in the GEOTRAINET training manual for designers of shallow geothermal systems, which can be downloaded from: www.geotrainet.eu/moodle/mod/forum/discuss.php?d=38. The table and figure appear as Table C1 and Figure C1 in MIS 3005 Issue 3.1.

Table 14: Ranges of thermal conductivity for different rock types, indicating recommended values

	Type of rock	Thermal conductivity (/W/mK)			
		Min	Max	Recommended	
Unconsolidated rock	Sand, dry	0.3	0.8	0.4	
	Gravel, dry	0.4	0.5	0.4	
	Peat, soft lignite	0.2	0.7	0.4	
	Clay/silt, dry	0.4	1.0	0.5	
	Clay/silt, water saturated	0.9	2.3	1.7	
	Gravel, water saturated	1.6	2.0	1.8	
	Claystone, siltstone	1.1	3.5	2.2	
	Sand, water saturated	1.5	4.0	2.4	
Solid Sediments	Hard coal	0.3	0.6	0.4	
	Gypsum	1.3	2.8	1.6	
	Marl	1.5	3.5	2.1	
	Sandstone	1.3	5.1	2.3	
	Conglomerates	1.3	5.1	2.3	
	Limestone	2.5	4.0	2.8	
	Dolomite	2.8	4.3	3.2	
Magmatites	Anhydrite	1.5	7.7	4.1	
	Salt	5.3	6.4	5.4	
	Tuff	1.1	1.1	1.1	
	Vulcanite, alkaline to ultra-alkaline	e.g. andesite, basalt	1.3	2.3	1.7

Metamorphic rock	Plutonite, alkaline to ultra-alkaline	Gabbro	1.7	2.5	1.9
		Diorite	2.0	2.9	2.6
	Vulcanite, acid to intermediate	e.g. latite, dacite	2.0	2.9	2.6
		e.g. rhyolite, trachyte	3.1	3.4	3.3
	Plutonite, acid to intermediate	Syenite	1.7	3.5	2.6
		Granite	2.1	4.1	3.4
	Slightly metamorphic	Clay shale	1.5	2.6	2.1
		Chert	4.5	5.0	4.5
	Moderately to highly metamorphic Vulcanite, acid to intermediate	Mica schist	1.5	3.1	2.2
		Gneiss	1.5	3.1	2.2
		Marble	1.3	3.1	2.5
		Amphibolite	1.9	4.0	2.9
e.g. rhyolite, trachyte		2.1	3.6	2.9	
Quartzite		5.0	6.0	5.5	

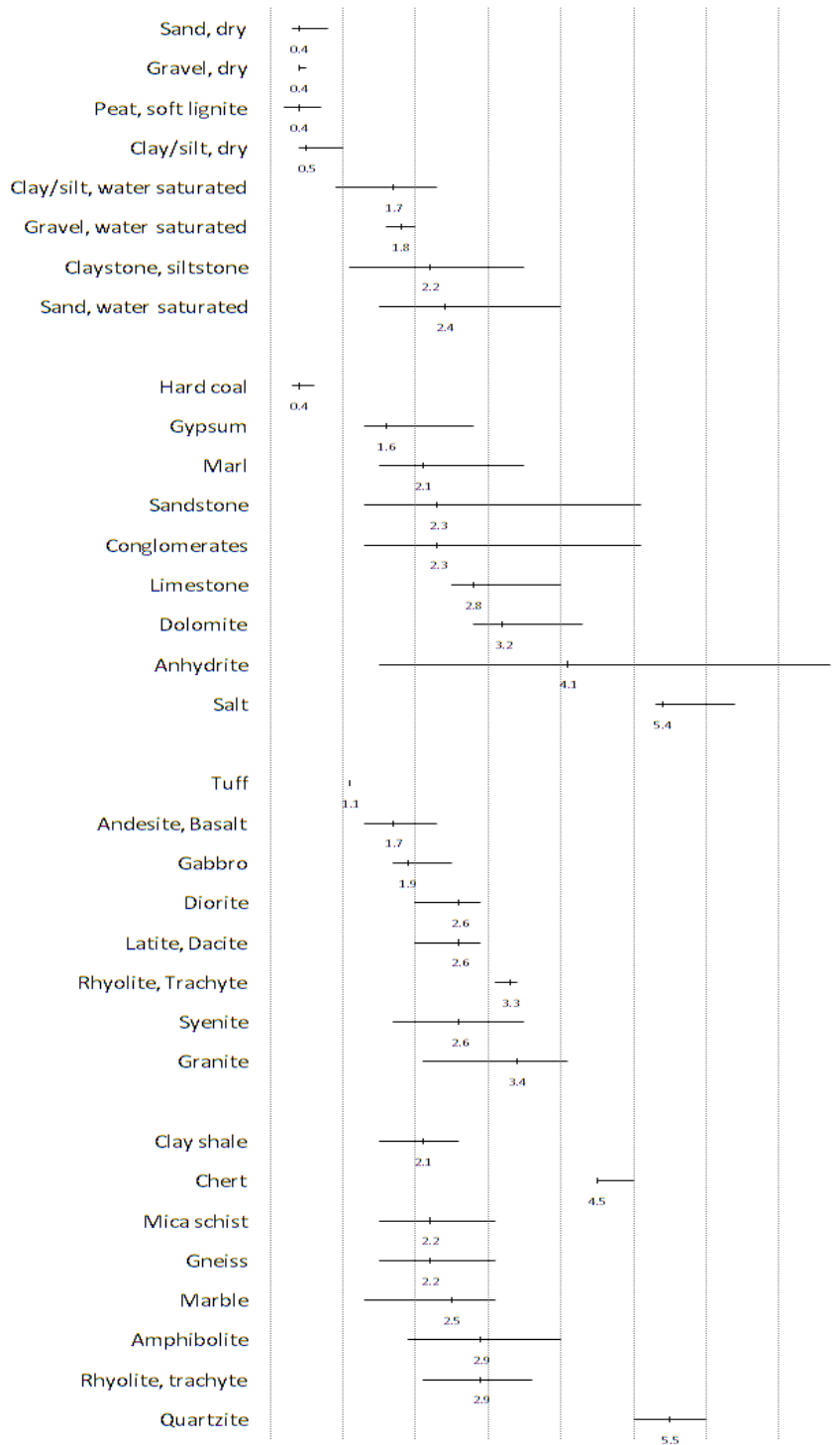
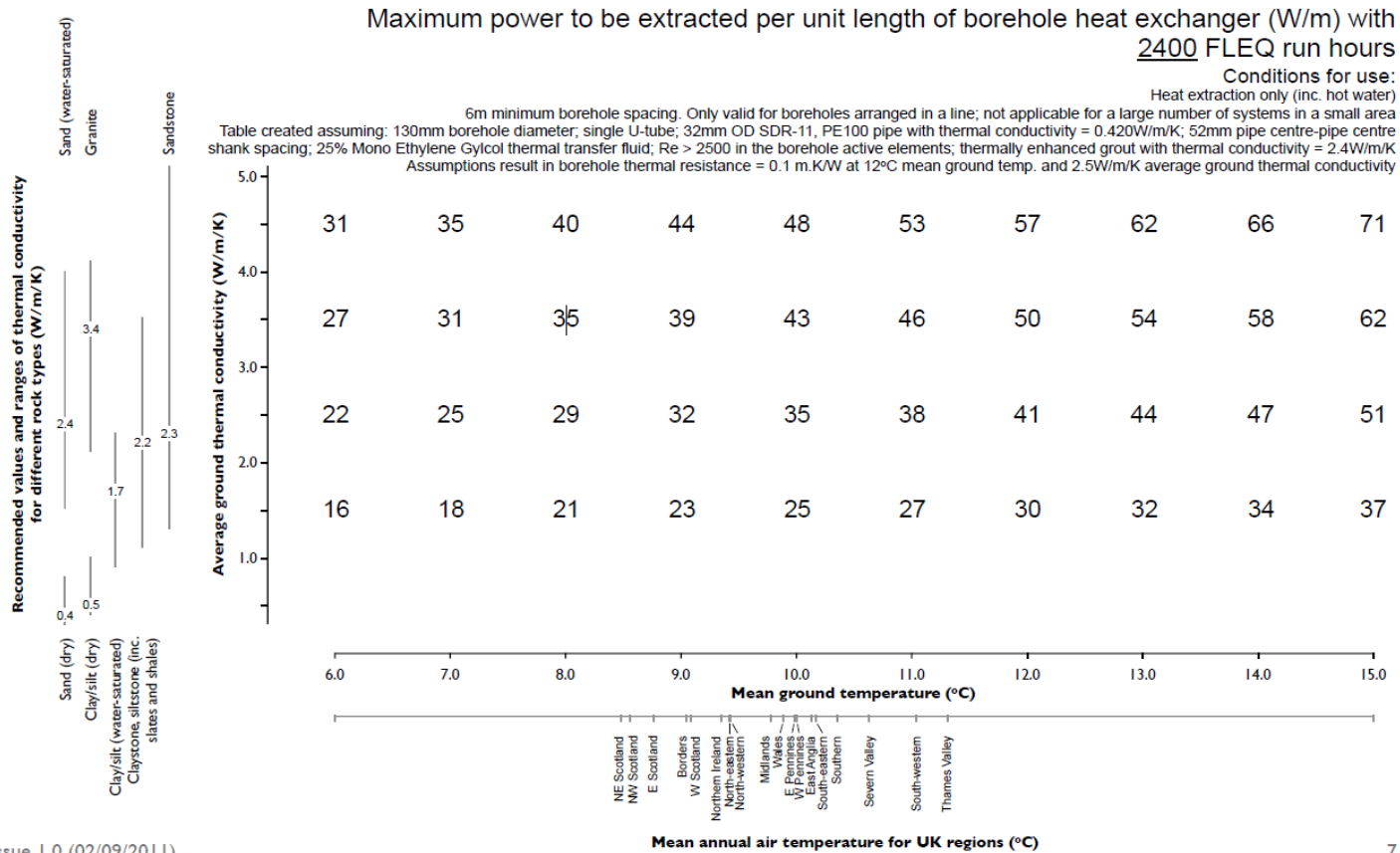

Figure 55: Ranges of thermal conductivity for different rock types, indicating recommended values. Horizontal lines represent the range of thermal conductivity for each rock type.

APPENDIX 7: EXTRACT FROM MCS 022 – GROUND HEAT EXCHANGER LOOK-UP TABLES. SUPPLEMENTARY INFORMATION TO MIS 3005 ISSUE 1.0: DRAFT EXAMPLE OF A VERTICAL GROUND LOOP LOOK-UP TABLE



Issue 1.0 (02/09/2011)

7

Figure 56: Draft example of a vertical ground loop look-up table

© Crown copyright 2012
Department of Energy and Climate Change
3 Whitehall Place
London SW1A 2AW
www.decc.gov.uk

URN 12D/018