

**SETS Development Road Map**  
for  
**Severn Embryonic Technology Scheme (SETS)**



3	Issued to SETS Board				
	P.M. Roberts	R. Tucker	-	R. Martins	04 March 2010
CURRENT REV	PREPARED BY	CHECKED BY	QA REVIEW	APPROVED BY	DATE

**© 2010 This document contains information proprietary to VerdErg Renewable Energy Ltd. and shall not be reproduced or transferred to other documents or disclosed to others or used for any purpose other than for which it is furnished without the prior written permission of VerdErg Renewable Energy Ltd.**

	DOCUMENT REF No:
	0974-400-PRG-001 Rev. 3
SETS DEVELOPMENT ROAD MAP	Page 2

## TABLE OF CONTENTS

	<b>Page No.</b>
<b>1. INTRODUCTION</b>	<b>3</b>
<b>2. KEY RISKS REMAINING TO BE ADDRESSED</b>	<b>8</b>
<b>3.0 WORK PACKAGES</b>	<b>13</b>
<b>3.1 WP 1 - Specialist Financial Consultancy</b>	<b>13</b>
<b>3.2 WP 2 - Long-term location for SETS Test-Rig</b>	<b>13</b>
<b>3.3 WP 3 - Safe passage of fish through SMEC installation</b>	<b>16</b>
<b>3.4 WP 4 - SMEC Installation in Inland Rivers</b>	<b>17</b>
<b>3.5 WP 5 - Business Development Targets</b>	<b>19</b>
<b>3.6 WP 6 - Modelling SMEC Environmental Footprint</b>	<b>21</b>
<b>3. TIMESCALES</b>	<b>23</b>
<b>4. ADDRESSING ENVIRONMENTAL ISSUES</b>	<b>26</b>
<b>5. COMMERCIALISATION</b>	<b>28</b>
<b>6. SUPPLY CHAIN ISSUES</b>	<b>35</b>
<b>6.1 Refinements to the Cost of Energy</b>	<b>38</b>
 <b>Appendices</b>	
<b>1. Scope of Work for CFD modelling of a free-passage gap in a SMEC array</b>	<b>43</b>
<b>2. Installation of SMEC into inland rivers</b>	<b>47</b>
<b>3. Carbon Trust MRP application for a small SMEC to be installed at a tidal lagoon site in the North foreshore, Belfast</b>	<b>50</b>
<b>4. General information about Woolston New Weir and diversion on the River Mersey</b>	<b>51</b>
<b>Record of Amendment</b>	<b>52</b>

	DOCUMENT REF No:  0974-400-PRG-001      Rev. 3
<b>SETS DEVELOPMENT ROAD MAP</b>	Page 3

## 1. INTRODUCTION

At the launch of the first Severn Tidal Power Consultation in January 2009, Ministers announced the creation of a Cross-Government fund for developing schemes incorporating embryonic technologies, which may offer the potential for less impact than conventional technologies on the natural environment of the Severn Estuary. This initiative is called the Severn Embryonic Technologies Scheme or "SETS" for short.

SETS is supported by the Department of Energy & Climate Change (DECC), Department for Environment, Food and Rural Affairs (DEFRA), Welsh Assembly Government (WAG) and South West Regional Development Agency (SWRDA).

The Objectives of the SETS are:

- To develop to outline design stage embryonic design and technology proposals with the potential to contribute to the Government's plan for tidal power generation in the Severn Estuary (i.e. to deliver a strategically significant amount of electricity at acceptable cost and with acceptable impact, including on the natural environment and on navigation).
- To increase the level of confidence in the technical feasibility of proposals (construction and operation), construction costs, energy yields and profiles, and cost of energy.
- To increase confidence levels in timescales for development and deliver a broadly costed technology development route map which sets out the path(s) to commercial deployment.

The programme is developed with the expectation that the technologies presented could be deployed commercially at scheme scale within 10-15 years.

On 19 August 2009, VerdErg Renewable Energy Limited was awarded a grant by The Secretary of State for Energy and Climate Change to assist it to carry out an initial work programme designed to raise the

	DOCUMENT REF No:  0974-400-PRG-001      Rev. 3
<b>SETS DEVELOPMENT ROAD MAP</b>	Page 4

development status of its Spectral Marine Energy Converter (SMEC) technology towards compliance with these Objectives.

This initial work is now complete and has succeeded in raising the development status of SMEC technology to a higher level, enabling a decision to be taken on the continuing development of SMEC technology towards meeting the SETS Programme Objectives.

This document presents the Development Road Map for this continuation of SMEC technology development. The Development Road Map is intended to assure sufficiently enhanced confidence levels in SMEC's development to achieve compliance with the SETS Programme Objectives, as set out above.

Implementing a course of actions that follow the Development Road Map will ensure that SMEC technology evolves in a timely fashion into an Investment-Grade candidate Power Generation technology appropriate to the commercial and environmental requirements of the Severn Estuary.

The Risk Register, document 0974-402-RSK-001, provides a quantified score for the Risk Levels associated with SMEC at the start of the SETS work in August 2009, some three years into the development by VerdErg of SMEC technology. This is shown as point "A" on the following graph. It also provides the reduced risk score as the SETS Programme work concluded in early 2010, shown as point "B".

Moreover, the Risk Register document identifies 6 Key Risks, four of which will be mitigated as shown in this Development Road Map before the end of 2011 and two which will be addressed by the start of the

Severn Estuary SMEC design. Finally, the Risk Document also calculates the risk score that will still exist when the Severn Estuary SMEC is commissioned; these risks include such operational issues as sabotage and various interactions with ambient shipping. These scores are shown as points "C", "D" and "E" on the following graph.

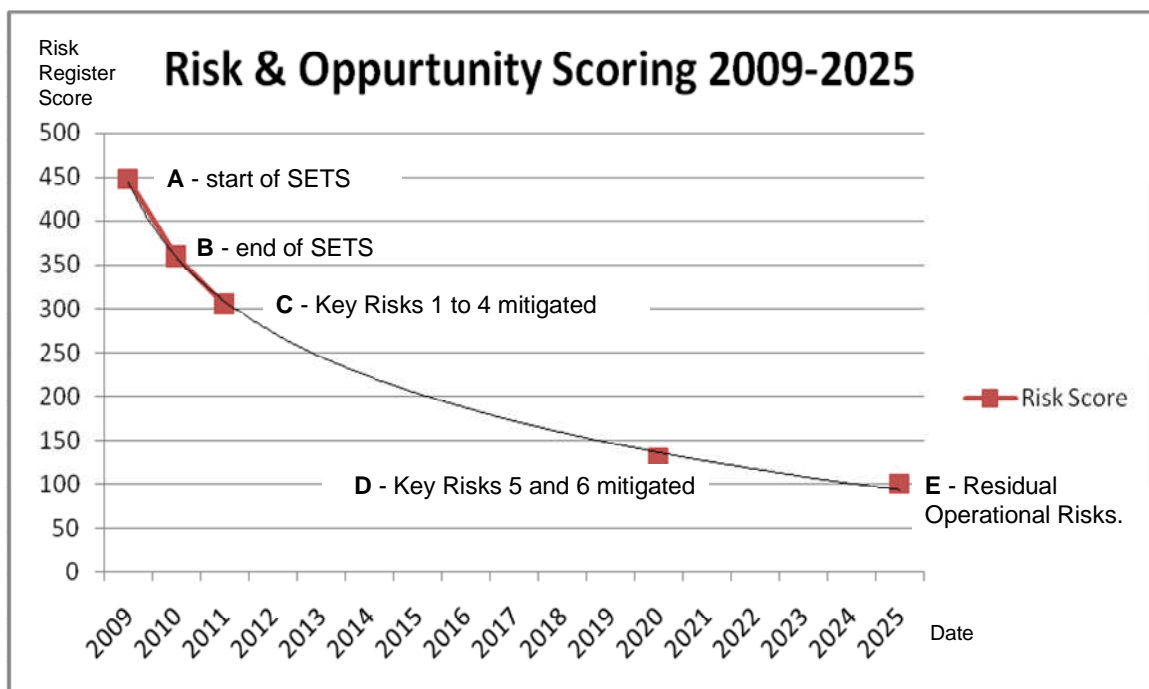

It can be seen that a logarithmic curve was found to fall almost perfectly through these points, as shown, when the commitment date to SMEC as the preferred technology for the Severn estuary was set at 2020 and the first power date at the end of 2025, as driven by the project schedule.

The conclusion, therefore, is that the SETS Programme has successfully executed a sequence of events that has reduced the risk levels of SMEC to a point where successful prosecution of the proposed Development Road Map can be expected to further de-risk SMEC

	DOCUMENT REF No:  0974-400-PRG-001      Rev. 3
<b>SETS DEVELOPMENT ROAD MAP</b>	Page 6

sufficiently for it to be considered as a candidate for adoption in 2020 for a crossing of the Severn Estuary.

This document presents the Development Road Map appropriate to this achievement of the SETS Objectives, matching the Key Risks to corresponding risk-mitigating Work Packages. A summary chart of the contents of this document concludes this section.

<b>TIME</b> Years from 1 Jan 2010	<b>Key Risk</b> Desired Outcome to be addressed	<b>Work Package</b> Summary of steps required to address Key Risk.	<b>Auditable Success Factors</b> Evidence Base to support mitigation of Key Risk
0 - 1	<b>1)</b> Find a client and supporting Grant Funding for the first small Commercial Demonstration SMEC installations.	<b>1)</b> Key Risk 1 is addressed by soliciting proposals from various successful investment-raising specialists and awarding an incentive contract to the winning Bidder. VerdErg has completed this process and has Franklin Associates under contract, seeking a suitable client. A major Strategic Investment Partner will also be identified in response to Key Risk 6.	Key Risk 1 has clearly been met when a client for the first Commercial Demonstrator has been found and supportive Grant Funding put in place.
0 - 1	<b>2)</b> Complete optimisation of the venturi diffuser detailed design through continued test programme.	<b>2)</b> Key Risk 2 is addressed by finding a University host facility into which the test rig can be re-located together with sufficient Grant Funding support, or sufficient Grant funding support to continue testing at the present commercial test house.	Key Risk 2 will be judged to have been met when the "water to wire" efficiency has been raised to a predetermined percentage of the theoretically available power.
0 - 1	<b>3)</b> Develop practical by-pass design to facilitate safe free passage of fish at acceptable risk level.	<b>3)</b> Key Risks 3 and 4 are addressed by building a CFD (Computational Fluid Dynamics) model under Work Package 3 of a SMEC containing an open gap suited to fish passage together with various mitigating configurations to minimise the head loss across the SMEC by encouraging helpful flow patterns to be created.	Key Risks 3 and 4 will each be judged to have been substantially mitigated when a free passage can be opened up to the transit through the SMEC of either fish or shipping without loss of more than a predetermined percentage of power, provisionally set at 10%.
0 - 1	<b>4)</b> Develop practical by-pass design to facilitate safe and convenient free passage of shipping.		
2 - 10	<b>5)</b> Secure a sequence of increasingly large SMEC commissions between 2011 and 2020 for commercial operation of installations as needed to validate Severn Estuary design. There are three steps: <ul style="list-style-type: none"> <li>o SMEC installations into rivers.</li> <li>o Tidal Current SMECs installed into increasingly large sites.</li> <li>o The final award in 2020 of the contract for the Severn Estuary SMEC.</li> </ul>	<b>4)</b> The earlier elements of Key Risk/Opportunity 5 is mitigated/promoted in this Work Package 4. The additional enabling work is to define the market for small SMECs in Inland Rivers which is thought to be potentially huge. <b>5)</b> Key Risk/Opportunity 5 is subsequently further promoted in this Work Package 5. The work is the marketing activity of securing a sequence of increasingly large tidal SMECs. <b>6)</b> Key Risk/Opportunity 5 is mitigated/promoted in this Work Package 6. This is the preparation of a major EIA specifically to enable the Severn Estuary SMEC to proceed.	Key Risk 5 (or opportunity) has clearly been met when the nominated commissions for SMEC installations are awarded, culminating in the award of the Severn Estuary contract.
0 - 2	<b>6)</b> Secure a major Strategic Investment Partner able to finance the rapid development of increasingly large SMEC installations.	Key Risk /Opportunity 6 is met by the ongoing commercial activity of Work Package 1.	Key Risk 6 has clearly been met when a major Strategic Investment Partner is in place.

	DOCUMENT REF No:  0974-400-PRG-001      Rev. 3
<b>SETS DEVELOPMENT ROAD MAP</b>	Page 8

## 2. KEY RISKS REMAINING TO BE ADDRESSED

The Risk Register sets out in detail all known residual risks and opportunities to be addressed in the development of SMEC and is presented in Document No: 0974-402-RSK-001 together with an accompanying commentary in which the Key Risks/Opportunities remaining to be addressed are identified. The Key Risks and Opportunities that were identified are as follows, listed in chronological order of mitigation:

1. Secure a **Client/Investor** to commission an initial Commercial Demonstration SMEC together with any appropriate Grant Funding support and Statutory Permits.
2. Complete **detail design optimisation of the Venturi Diffuser** design to further reduce the head drop across the SMEC that is needed to achieve target power delivery, and to thereby improve both the economic and environmental performance of SMEC installations. This ongoing design refinement should incorporate more detailed investigation of the possible benefits of naturally occurring marine growth on SMEC installations.

A good analogy can be drawn with the development of aircraft wing aerofoil design over much of the last century including high-lift, low speed flow management devices such as "Slats" and "Slots". Very similar physical parameters are involved with the ongoing optimisation of SMEC Venturi Tube section design. Taking SMEC performance further up the "Learning Curve" towards its theoretically possible performance limits will be a much quicker process of maybe one to two years, however, because:

- There is a great deal of research already published in the public domain about conical diffuser design and a reasonable amount of published insight specifically into other diffuser



	DOCUMENT REF No:  0974-400-PRG-001      Rev. 3
<b>SETS DEVELOPMENT ROAD MAP</b>	Page 9

configurations such as annular and rectangular. SMEC uses what might be called a “quasi-infinite linear venturi” which is closely related to rectangular venturi diffusers. The SETS programme schedule did not permit time to collate and absorb the full published body of State-of-the Art knowledge on Venturi Diffuser Design.

- There is a vast body of knowledge relating to aircraft wing design which has not been accessed specifically at all during this work. One particularly relevant body of knowledge is thought to be the development of high-lift wing design and low speed stall-prevention technology, including boundary layer management techniques. In some ways, the SMEC venturi design may be thought simpler because it works in an incompressible fluid, although aircraft wings do not suffer from the issues that occur in water flow relating to cavitation.
- The SETS programme testing has made a substantial inroad into the reduction of this Key Risk. A clear improvement has been achieved by design refinements introduced towards the end of the test sequence in late January 2010 and these steps down the SETS Development Road map give a clear signpost of the direction forwards for the continuation of this work after SETS, to determine optimised SMEC performance levels achievable as the technology matures.

This design evolution of the SMEC Venturi Tube cross-section during SETS passed through four steps, indicated below diagrammatically. They were:

- An arbitrary symmetrical hexagonal shape was selected as a starting configuration. The maximum realistic test section length of 2m gave a Diffuser Angle of around 22 degrees, rather steep by comparison with the 8 degrees recommended for cylindrical venturis. Good Secondary Flows were

	DOCUMENT REF No:  0974-400-PRG-001      Rev. 3
<b>SETS DEVELOPMENT ROAD MAP</b>	Page 10

obtained but higher than desired driving heads were needed indicating energy losses in the Diffuser.

- A Spacer was added to give two Diffuser sections of around 8 degrees which reduced the losses and improved performance. However, a tendency for the flow to flip randomly from one branch to the other (like a fluidic control logic gate) was observed.
- A Separator Plate was added which provided equally divided flows into each Diffuser, further improving performance. Some “Coandă Effect” was observed with the flow adhering preferentially to the surface of the Spacer.
- Tests are underway at the time of writing with the surface of the Spacer roughened deliberately to promote flow detachment from the Insert and help to further improve achievement of uniform pressure recovery.

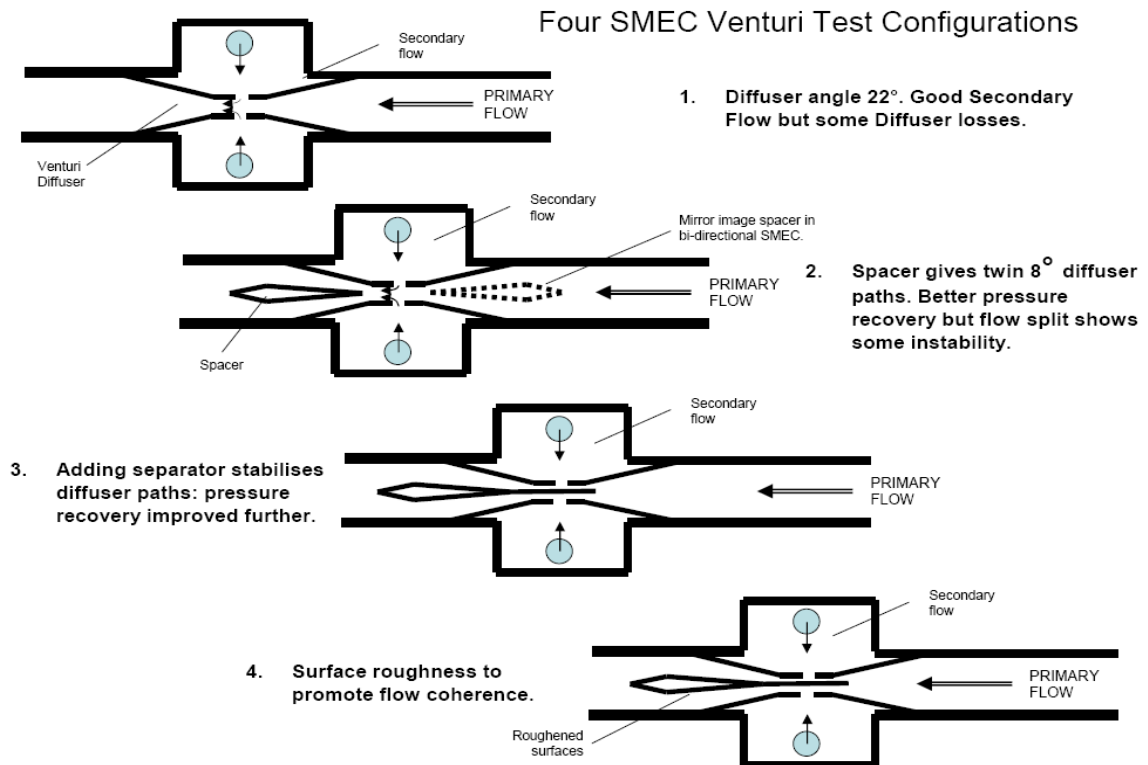

The final issue in this Key risk is to establish that the refined Venturi Tube cross-section design functions well not only in the closed channel test rig but in a full scale test of a SMEC in water with a free surface. This will take the technology to the end of TRL 6 as described later.

3. It is necessary to complete the development of a practical **by-pass design to facilitate fish movements** through a SMEC installation at acceptably low risk to the fish.
4. Complete the development of a **practical by-pass design to facilitate shipping/boating movement** through a SMEC installation at lower cost and more convenience than would be provided by a conventional lock. The challenge is to limit the power lost through by-pass flow preferentially selecting the opening.
5. Commission second and subsequent **key SMEC Installations** to ensure that the Development Road Map provides progressive

	DOCUMENT REF No: 0974-400-PRG-001      Rev. 3
<b>SETS DEVELOPMENT ROAD MAP</b>	Page 12

experience sufficient to prepare SMEC as a suitable Investment-Grade technology for the Severn Estuary.

6. Attract a major **Strategic Investment Partner** with the funding and appetite to permit sufficiently rapid progress along this SETS Development Road Map.

Alternatively, these Key risks can also be grouped by type as follows:

- Technology Key Risks:
  - Detail design optimisation of the Venturi Diffuser.
  - Commission second and subsequent key SMEC Installations.
- Environmental/Stakeholder Key Risks/Opportunities:
  - By-pass design to facilitate fish movements.
  - Practical by-pass design to facilitate shipping/boating movement.
- Financial Key risks:
  - Secure a Client/Investor and Grant Funding support to commission an initial Commercial Demonstration SMEC.
  - Attract a major Strategic Investment Partner.

	DOCUMENT REF No:  0974-400-PRG-001      Rev. 3
<b>SETS DEVELOPMENT ROAD MAP</b>	Page 13

### **3.0 WORK PACKAGES**

The following list of Work Packages has been identified as the appropriate top level Work Breakdown Structure needed to secure successful and timely compliance of SMEC with the SETS Programme Objectives established in Section 1 above.

#### **3.1 WP 1 - Specialist Financial Consultancy**

A Specialist Financial Consultancy is required to seek, evaluate and secure investment funding which will be needed for the ongoing development of SMEC. An appropriate party was appointed to this role by VerdErg in December 2009. Approximately 50 potential investment Companies and Agencies have already been approached, many of which are potentially interested in SMEC and with which VerdErg has ongoing discussions. Further details are given below in Section 6 "COMMERCIALISATION".

This Work Package 1 is targeted at Key Risk 1 above which is finding the first client for a small SMEC, as an early step along the Development Road Map. In fact, however, Work Package 1 also sets the groundwork for the later activity of addressing Key Risk 6, which is finding a longer term Strategic Investment Partner for VerdErg.

#### **3.2 WP 2 - Long-term location for SETS Test-Rig**

VerdErg will find, as needed, a longer-term location for the SETS test-rig to permit ongoing investigation of optimal venturi diffuser design

	DOCUMENT REF No:  0974-400-PRG-001      Rev. 3
<b>SETS DEVELOPMENT ROAD MAP</b>	Page 14

details in response to the mitigation of Key Risk 2. Agencies currently in discussion with VerdErg include:

- BHR Group, Cranfield where the present tests were conducted.
- University of East London
- Welsh Assembly Government – a meeting is scheduled to help find a suitable site in Wales, either with a University or Industrial host.
- University College London
- Imperial College London
- University of Plymouth
- University of Exeter at Falmouth
- Joule Centre, Manchester University
- University of Lancaster
- A further possibility exists to re-assemble the test apparatus at VerdErg’s premises. There are two possible locations, the Industrial Estate in Knaphill, Surrey where VerdErg has its Head Offices and the Industrial Premises in Birkenhead on The Wirral, where it assembles and tests its products.

A number of other possible hosts to this test apparatus have been approached and declined for a variety of reasons including insufficient space or specialisation. Others are conflicted by association with competing technologies including Edinburgh University. There are several more possible host facilities on a candidate list that have not yet been approached. These include:

- Cranfield University
- Qinetiq test facility at Haslar. (Cavitation Tunnel)

	DOCUMENT REF No:  0974-400-PRG-001      Rev. 3
<b>SETS DEVELOPMENT ROAD MAP</b>	Page 15

- Newcastle University, Emerson Institute. (Cavitation Tunnel)
- NAREC at Newcastle on Tyne.
- Portsmouth University
- Southampton University
- Birmingham University.
- Aberdeen University
- The Robert Gordon Institute

Some key parts of the test rig will remain the property of VerdErg as the current tests complete and these parts will then probably be put into storage at BHR Group or VerdErg premises until a new host location and supporting funding is finalised. Other key elements of the rig, including the pumps, much of the instrumentation and the receiving tank sections belong to BHR Group and will be re-used on other BHR Group projects. Once a host is identified that wishes to house the apparatus and conduct ongoing tests, appropriate funding will be required to rebuild the receiving tank, rent pumps and procure new instrumentation before rebuilding the test rig.

Alternatively, BHR Group can simply be commissioned to continue the testing at their premises if this is financially plausible. A commercial test house such as BHR Group, however, may not be thought the most appropriate location for ongoing research over a year or more as the opportunity for several Post-Graduate theses to be prepared on this important technology could be lost.

A supplementary element of Work Package 2 is to tank test a full-scale model of smaller SMEC to be able to confidently claim achievement of TRL (Technology Readiness Level) 6, as described later under "Commercialisation". The venturi section design optimisation will be

	DOCUMENT REF No:  0974-400-PRG-001      Rev. 3
<b>SETS DEVELOPMENT ROAD MAP</b>	Page 16

addressed in a closed conduit, so it is prudent to show that the whole system functions as expected under a real free water surface. The forces on the scale model due to waves will also be investigated. Several Universities in England & Wales have expressed interest in hosting this test.

### **3.3 WP 3 - Safe passage of fish through SMEC installation**

Key Risks 3 and 4 relate to providing free safe-passage through a SMEC installation at a small scale for fish and at a large scale for shipping.

A study of fish passing through the gap of the Venturi will be undertaken. However, the preferred technique is to configure the SMEC turbine inlets local to a gap in the SMEC to manage the flow and thereby limit the consequent loss of driving head between the upstream and downstream sides of the SMEC.

Specialist CFD consultancy has been commissioned as Work Package 3 to study managed flow patterns through gaps in a SMEC. TRIVISTA Engineering was commissioned to undertake this work on 30th December 2009. The scope of work for this study is included as Appendix 1.

Preliminary discussions have been held with Cardiff University on behalf of the Welsh Universities that have indicated an interest in taking this work further.



	DOCUMENT REF No:  0974-400-PRG-001      Rev. 3
<b>SETS DEVELOPMENT ROAD MAP</b>	Page 17

### 3.4 WP 4 - SMEC Installation in Inland Rivers

As an early part response to Key Risk 5 regarding promoting the ideal-flow of early SMEC installation opportunities, a proposal for Work Package 4 is under development with JBA Consulting to demonstrate the potential of the SMEC market for installation in Inland Rivers. Some notes on SMEC installations in a river together with an outline of JBA Consulting are given in Appendix 2.

One of the points raised is how close together can SMECs be placed down a river without interfering with the power output of the next SMEC upstream. Preliminary discussion has been held on these subjects with representatives of the Welsh Assembly Government and the University of Wales and it is hoped that further targeted discussions will follow.

It is believed that SMEC installations in inland rivers is a very attractive prospect for a number of reasons including:

- SMECs placed across inland rivers will be of a modest size on average, to suit modest levels of early stage funding.
- It is believed that flights of SMEC installations can be made at regular intervals down many rivers. Initial calculations indicate that an extremely large quantity of predicable renewable energy can be obtained in this way.
- The absence of tidal fluctuations means that the annualised average output of a SMEC in a river is a much higher percentage of the system capacity than the same SMEC would experience under a tidal flow regime. In other words, its utilisation is inherently superior.

	DOCUMENT REF No: 0974-400-PRG-001      Rev. 3
<b>SETS DEVELOPMENT ROAD MAP</b>	Page 18

- A SMEC designed for a river need not be bi-directional which simplifies the design.
- Population centres have historically grown up alongside rivers initially for access to drinking water and transportation and then early in the Industrial Revolution, also for access to mechanical power for milling and weaving. Power from river SMECs will therefore be generated close to its consumer base, saving on the cost and environmental impact of the transmission facilities needed where the consumer is remote from the point of generation.

Design Studies undertaken by VerdErg indicate that a SMEC, installed into a river, may be best configured with horizontal rather than vertical Venturi Tubes. Power output calculations are unchanged but some detailed risks, such as undue free surface depression in the venturi can be addressed this way. A sketch of a small SMEC with horizontal Venturi Tubes follows:

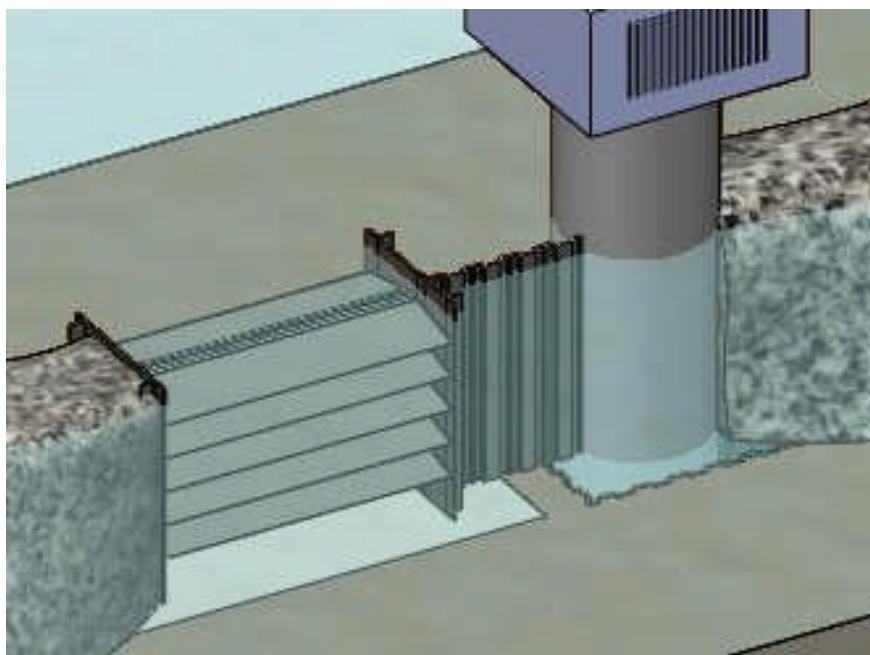

	DOCUMENT REF No:  0974-400-PRG-001      Rev. 3
<b>SETS DEVELOPMENT ROAD MAP</b>	Page 19

### 3.5 WP 5 - Business Development Targets

Work Package 5 is a convenient way to collect and list the major Business Development Targets for increasingly large SMEC installations over the initial years of its commercial life, prior to the commissioning of the Severn Estuary crossing. These increasingly ambitious commercial installations address ongoing mitigation of Key Risk 5 and help ensure that SMEC is sufficiently de-risked in good time to be available for installation across the Severn Estuary.

During the course of this activity a significant amount of risk reduction takes place organically as detailed design solutions to the various mid-range risks on the Risk Register are developed and operating experience accumulates. Examples include:

- Development of inspection and maintenance equipment and procedures needed to clean marine growth off the Venturi Tubes or clear sediment out of the secondary flowpath.
- Refinement of the modelling within SIMULINK of multiple turbine operating patterns and interactions at varying points in the tidal cycle.

This accumulation of multiple risk mitigation under increasing operating experience from SMECs built with funding from a Strategic Partner is fully documented in the relevant Risk Register included in report 0974-402-RSK-001. The quantified total reduction in the risk score of these multiple small risk mitigations is graphed in the "Introduction" section above as the risk reduction between points "C" and "D".

The following development locations have been chosen as the ideal Target Set of candidate sites to support de-risking SMEC technology for

	DOCUMENT REF No:  0974-400-PRG-001      Rev. 3
<b>SETS DEVELOPMENT ROAD MAP</b>	Page 20

the Severn Estuary in this way.

The Business Development Targets under consideration as Work Package 5 at the time of writing are:

- Tidal Lagoons and Loughs in Northern Ireland working with FlowPower Ltd and Newmills Hydro Turbines Ltd (NHT). A third nominated partner in this proposal was CORUS, the major UK-Dutch Integrated Steelmaker. A joint proposal was made with these Partners to the Carbon Trust MRPF in November 2009 for a small (300Kw) SMEC installation in a Tidal Lagoon on the Belfast Northern Foreshore. A copy is attached in Appendix 3. A letter of support was received from Belfast Civic Authorities.

This application to the Carbon Trust was not selected for funding under MRPF. It is thought that the proposal, made under very severe time pressure, was not as complete as may have been required. A full de-briefing is pending.
- Possible installation of a small SMEC in the Mersey near Woolston New Weir and Lock, or similar site. There are numerous advantages to this site including good access, existing site facilities and a high flow rate. Some information on Woolston New Weir and Lock is included in Appendix 4. A generally supportive preliminary response has been informally received from the site owners.
- Large Streams or small Rivers anywhere in the UK are a major early sales target for SMEC as mentioned under Work Package 4. Preliminary discussions have been held with several owners including the RSPB and VerdErg has a Partnership with FlowPower Ltd that has been working to develop this market commercially for some time.
- The Solway Firth, Wyre Estuary and Duddon Estuary Crossings in the North-West of England and Southern Scotland provide a very suitable incremental set of mid-sized tidal energy installations. All

	DOCUMENT REF No:  0974-400-PRG-001      Rev. 3
<b>SETS DEVELOPMENT ROAD MAP</b>	Page 21

have been visited and ongoing discussions are in hand with the interested local Parties.

- The Menai Strait between the Welsh mainland and Anglesey offers the advantages of a high tidal flow and compact size. This more exposed SMEC installation might generate up to 60 MW capacity. Initial discussions were held with the Welsh Assembly Government on 22<sup>nd</sup> January 2010.
- A larger estuary crossing using SMEC technology, but still smaller than the Severn, has been discussed with several potential clients and further discussions are planned. This major installation would be the perfect precursor installation trialling the Severn Estuary SMEC design concept on a somewhat smaller scale.

### **3.6 WP 6 - Modelling SMEC Environmental Footprint**

Prior to commitment of SMEC technology to the Severn Estuary crossing, which completes the mitigation of Key Risk 5, a virtual model forming Work Package 6 will be commissioned of the Environmental Footprint on a macro-scale of a SMEC across the Severn Estuary, to include its impact not only on plant and animal life but on the sedimentary, land drainage and tidal patterns around the UK and Northern European Coastline.

As a linked part of this Work Package, it will be necessary to incorporate this model into a Quantified Risk Assessment (QRA) of the Severn Estuary SMEC installation and to use the model to support the necessary macro-scale Environmental Impact Assessment (EIA) of a SMEC across the Severn Estuary. Further attention will be paid in these reports to any outstanding issues relating to the changes in Design Criteria possibly occurring as a result of Global Warming. The development of the virtual model centres on an advanced

	DOCUMENT REF No:  0974-400-PRG-001      Rev. 3
<b>SETS DEVELOPMENT ROAD MAP</b>	Page 22

conceptual design of the Severn Estuary SMEC installation picking up from the end point of the SETS work, incorporating all the lessons learnt from Work Packages 1 through 5.

The very first activity in this advanced conceptual design is to select the alignment to be adopted. It has been a clear conclusion of SETS that the Minehead-Aberthaw alignment has some potential advantages as regards Shipping Patterns, Dredging Impact and Sedimentation. It was set aside at the end of SETS because its Cost of Energy was slightly inferior to that from the Cardiff-Weston alignment resulting from the lower velocity regime across the Minehead-Aberthaw alignment. However, that unit cost balance might be reversed by blockage of selected parts of the installation, possibly raising the average velocities allowing the advantage of the higher volumetric flow rate to be exploited. A full exploration of the cost-benefit trade-offs relevant to Minehead-Aberthaw requires CFD Modelling outside of the SETS Scope-of-Work and would benefit greatly from access to the overall refinement of SMEC technology to be made under this Road Map over the next few years. Performing this work at the start of Work Package 6 is therefore proposed.

It is worth noting that a substantial body of measured actual environmental data will also need to be gathered over a period of a year or more prior to the commencement of this design work. Much of the environmental data available was gathered to support the design of a conventional Barrage which is not necessarily appropriate to support the design of a SMEC.

	DOCUMENT REF No:
	0974-400-PRG-001 Rev. 3
<b>SETS DEVELOPMENT ROAD MAP</b>	Page 23

### 3. TIMESCALES

The attached two schedules provide detailed insight into the timing, duration and inter-relationships of SMEC development activity needed to ensure that SMEC technology can be confidently selected for use on the Severn Estuary. The timing proposed shows the Severn Estuary Capital Expenditure approved in mid-2020, in good time to lead to first electrical power availability in 2025 and final completion in late 2026.

It is emphasised that timely compliance with this schedule is predicated on the successful mitigation of the Six Key Risks through execution of the Six Work Packages defined earlier in this document. This can only be achieved with Public Funding Assistance over the next two years, until SMEC has achieved Technology Readiness Level 7.

A very condensed high level summary of this schedule is given below for the general reader:

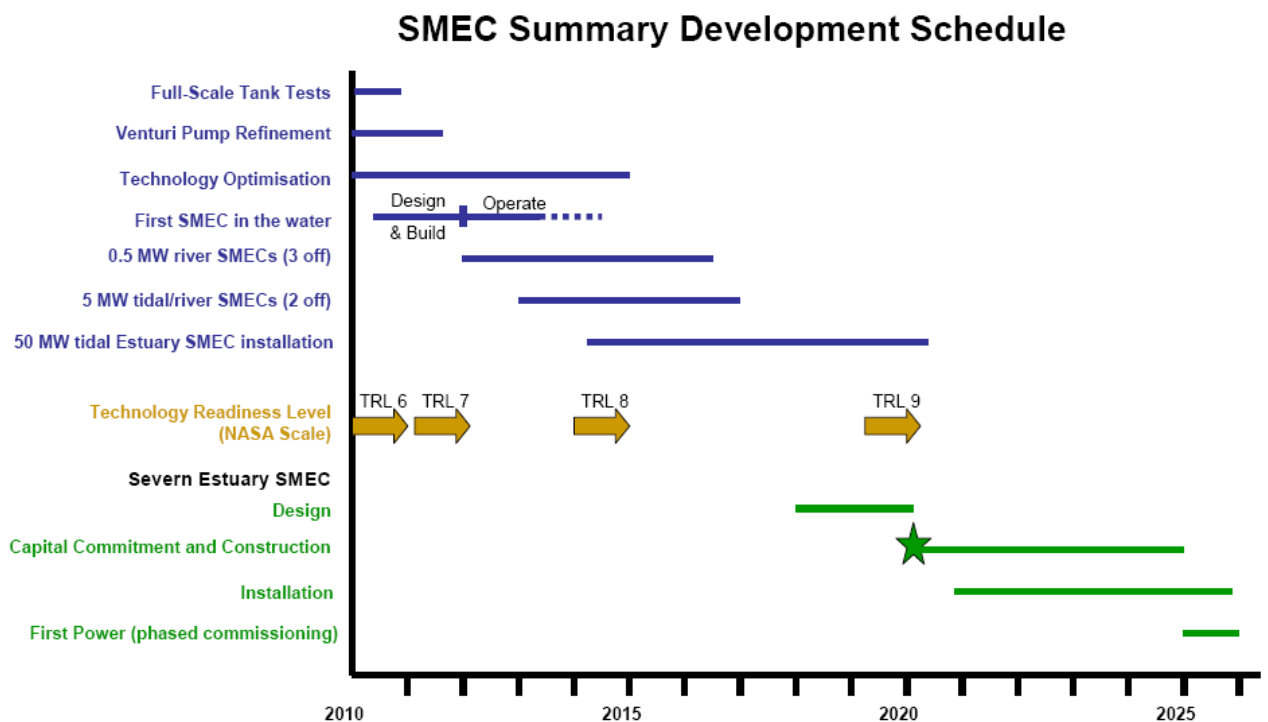









DOCUMENT REF No:

0974-400-PRG-001 Rev. 3

SETS DEVELOPMENT ROAD MAP

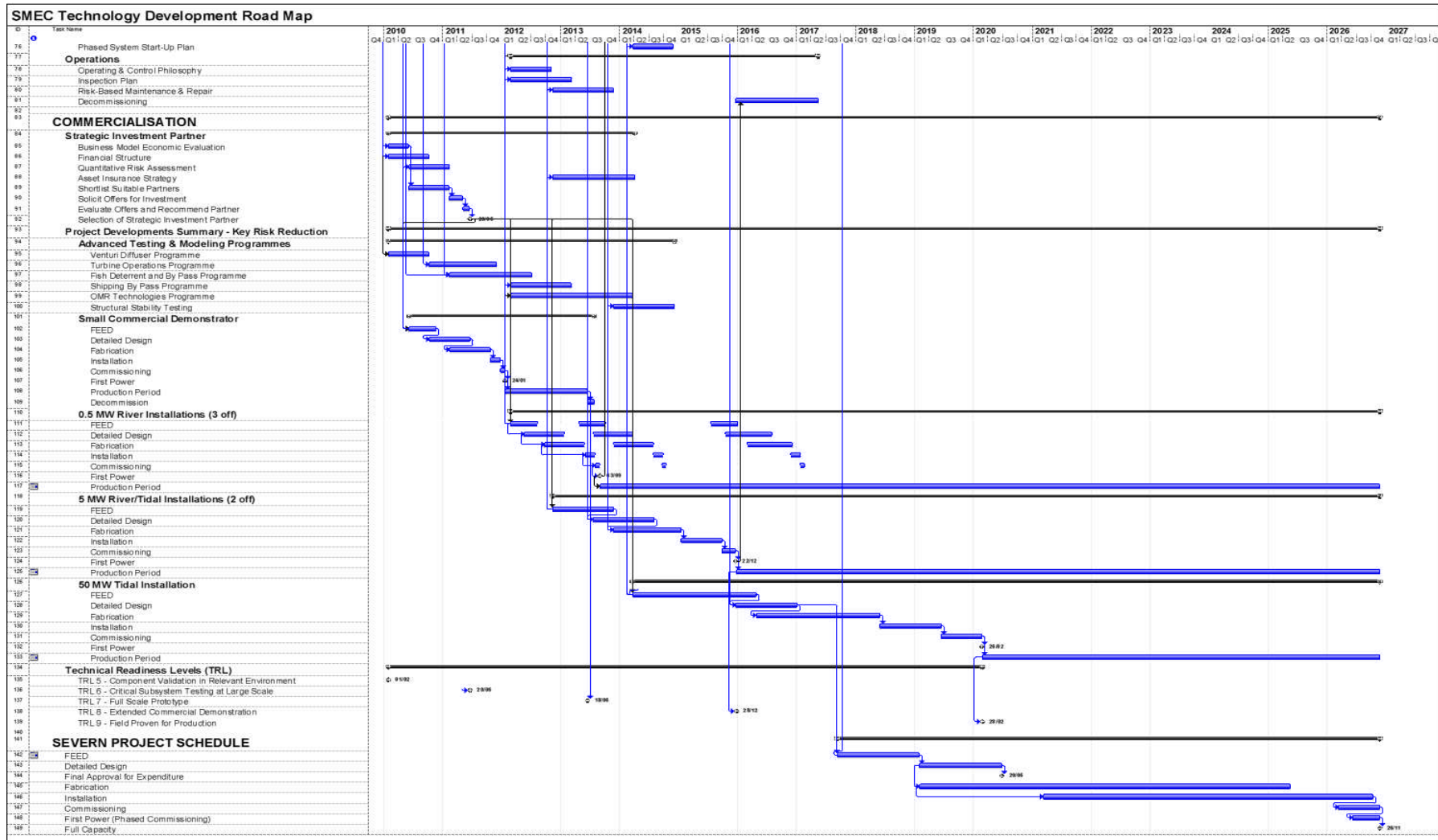
Page 25



	DOCUMENT REF No:  0974-400-PRG-001      Rev. 3
<b>SETS DEVELOPMENT ROAD MAP</b>	Page 26

#### **4. ADDRESSING ENVIRONMENTAL ISSUES**

Before raising the finance needed to install a SMEC across the Severn Estuary, a major Environmental Impact Assessment (EIA) based on a Quantified Risk Assessment (QRA) will be needed as noted in Work Package 6 above. Such an EIA and QRA require high-integrity credible data on SMEC performance derived from real-life installations, operational in a real environment.

It is a requirement therefore that all the steps along the Development Road Map be taken in a timely fashion and that all SMEC installations in the first years carry appropriate instrumentation to support development of the high-integrity EIA and QRA Data Base outlined under Work Package 6 for a major SMEC installation across the Severn Estuary. As noted under the discussion on Work Packages above, one key element of this EIA is development of models of the wider coastal environment and social infrastructure which might well be impacted and also possibly improved by such a substantial Infrastructure Development. This work needs to be commissioned well in advance of the Capital Commitment date for the project. The work currently being undertaken by HR Wallingford for the SEA may prove to be applicable or adaptable to a SMEC installation.

Regarding the early actions needed, sufficient design work is needed to support Statutory Approvals for the small prototype Commercial Demonstration installations from which actual validating performance data will be gathered. These installations might be regarded as temporary to facilitate such Permits, but supportive estimates will still be needed. In this context, key Work Packages are those that address the environmental impact of SMEC on migratory bird-life and estuary fish, namely Work Packages 2 and 3.

	DOCUMENT REF No:  0974-400-PRG-001      Rev. 3
<b>SETS DEVELOPMENT ROAD MAP</b>	Page 27

A major impact of SMEC on migratory birds is a function of how much of their inter-tidal habitat is permanently inundated by the installation. The calculation of this flooded area is controlled by the accuracy of the performance calculations that can be performed and is therefore one of the key outputs that depend not just on the SETS work undertaken to date but on its continuation under Work Package 2 above. The results obtained from SETS are very encouraging.

Another major consideration regarding the interaction of SMEC with its environment relates to the presence in the Severn Estuary of protected areas (Special Areas of Conservation, Special Protection Areas, Ramsar Sites) and of internationally significant bird species such as Bewick's Swan and the White-Fronted Goose. This work sits beyond the scope of the Environmental Overview commissioned under SETS and will form part of the scope of Work Package 6, which contains a full EIA.

The interaction of SMEC with ambient marine animals is more pragmatic in as much as it is influenced by the effectiveness of the various commercially available behavioural fish deterrent technologies such as Bubble Screens, Strobe Lighting and Bio-Acoustic arrays, when compared to physical screens. This is best evaluated from the real-World prototype Commercial Demonstrators resulting from the earlier stages of Work Package 5, to show that the promise of these technologies can actually be delivered in practice.

However, there is one specific piece of technology development outstanding under Work Package 3 above that will determine the extent of the gaps that can be designed into a SMEC without undue economic impact. Such gaps will permit fish (and boats/shipping) to pass freely. Work Package 3 was commissioned at the end of 2009 and is currently underway. Some details are given in Appendix 1.

	DOCUMENT REF No:  0974-400-PRG-001      Rev. 3
<b>SETS DEVELOPMENT ROAD MAP</b>	Page 28

## 5. COMMERCIALISATION

Work Package 1 is the key activity towards securing the successful commercialisation of SMEC. VerdErg has canvassed a large number of potential investor companies and as noted earlier, has now appointed a Financial Services Consultancy to lead this ongoing campaign.

It became apparent some years ago that there was, as a generalisation, a shortcoming in the early-stage investment community, whereby companies without the enabling finance were left unable to take a nascent Innovative Technology across the gap between the end of development and the achievement of true commercial application with non-technological Clients. This is now known to be a well-documented phenomenon that has attracted a considerable volume of Business Literature.

Amongst the steps taken internationally to help identify and isolate this problem of “Crossing the Valley of Death” as one well-known Business Guru has it, is the development of various metrics for measuring and calibrating the progress of innovation from “Eureka Moment” to Commercial availability.

The Technology Readiness Level (“TRL”) metric developed by NASA has been quite widely adopted in the UK for the purposes of characterising the readiness of Renewable Energy Devices for commercial application. NASA’s TRL scale was applied to the Tidal Current Energy development context by Southampton University for DECC in 2008. It’s recommended Protocol is as follows:

**Table 1. NASA TRL terminology compared to Stages used in the Protocol**

TRL	NASA description	Tidal-current Protocol	Protocol Stage
1	Basic principles observed and reported	Not applicable – this refers to fundamental scientific research.	
2	Technology concept and/or application formulated	Tidal-current energy conversion concept formulated (Scope of Protocol begins here)	1
3	Analytical and experimental critical function and/or characteristic proof-of concept	<ul style="list-style-type: none"> <li>▪ Subsystem testing at intermediate scale</li> <li>▪ Computational Fluid Dynamics</li> <li>▪ Finite Element Analysis</li> <li>▪ Dynamic analysis</li> </ul>	2
4	Component and/or breadboard validation in laboratory environment		
5	Component and/or breadboard validation in relevant environment	Subsystem testing at large scale	3
6	System/subsystem model or prototype demonstration in a relevant environment (ground or space)		
7	System prototype demonstration in a space environment	Full-scale prototype tested at sea	4
8	Actual system completed and “flight qualified” through test and demonstration (ground or space)	Commercial demonstrator tested at sea for an extended period. (Scope of Protocol ends here)	5
9	Actual system “flight proven” through successful mission operations	Production	

	DOCUMENT REF No:  0974-400-PRG-001      Rev. 3
<b>SETS DEVELOPMENT ROAD MAP</b>	Page 30

It can be seen from this Protocol that SETS has taken SMEC through TRL 5 and into TRL 6 to the point where it sits close to the end of “Subsystem Testing at Large Scale”. SETS has tested the most critical subsystem, the Venturi Pump, at full scale but a full-scale tank test of the whole device with a real-World free surface might be thought to be a prudent further measure to achieve TRL 6 without dispute.

The challenge for the Development Road Map, therefore, is to complete the achievement of TRL 6 and enable the continuing progress of SMEC through TRL 7 and TRL 8. This means financing the acquisition of full-scale Prototype experience with Commercial Demonstrators “in the water”. Normal investment finance is only available for established, low-risk propositions that offer quite rapid, even if modest, returns at a high degree of confidence. Even though a lower probability of successfully achieving a higher return equates mathematically to the same benefit, it is much harder to finance, in general.

VerdErg, therefore, plans to guide SMEC through this Commercial Demonstrator phase using two of the three known sources of finance that do not rely on short-term, predictable corporate value growth as collateral. The three such plausible sources of early-stage funding are:

1. Self-funding. This source is virtually exhausted. VerdErg has already committed over £500,000 of its own funds to SMEC development and cannot afford significant additional funds.
2. Government Grant Funding where an investment of public funds is made to create national advantage in a future Global Market.
3. Third Party funding combined with a Pilot Project commission from a commercial Client seeking competitive advantage rather than predictable early sales revenue, possibly in conjunction with an

	DOCUMENT REF No:  0974-400-PRG-001      Rev. 3
<b>SETS DEVELOPMENT ROAD MAP</b>	Page 31

equity investment. Such a client may commission such a new technology Pilot Project as a “Business Development” investment to gain competitively superior access to a new market or to gain a “Public Relations” advantage over its competitors by making an auditable demonstration of its commitment to environmental progress.

For planning purposes, therefore, VerdErg has chosen to seek a combination of funding sources 2 and 3 to get the all-important first Prototype “into the water” and to improve the development status of SMEC to reach TRL 6, TRL 7 and TRL8.

The importance of Government Funding to getting the first Prototype into the water cannot be over-estimated as it seems likely that a Commercial Client for such an early installation will be found much more readily once co-investment through Government Support can be shown to be in place. A number of such Client organisations have already expressed “in principle” interest to VerdErg.

Note the relevance of the Regional Development Agencies to this need for Government Funding. Several are actively offering help. Presentations were made to the Welsh Assembly Government on 22<sup>nd</sup> January 2010 and are planned to be made to the North-West Regional Development Agency (NWRDA) on February 1<sup>st</sup> and again to its Tidal Energy Group at its next meeting in late March 2010. The NWRDA is seeking regional funding support for SMEC installations at sites within its jurisdiction including those noted below. A meeting with the Scottish RDA was held on January 15<sup>th</sup> and contact has been made by telephone with the SWRDA; discussions are ongoing.

	DOCUMENT REF No:  0974-400-PRG-001      Rev. 3
<b>SETS DEVELOPMENT ROAD MAP</b>	Page 32

Regarding UK Government Grant Funding available to move some strategically important technology through TRL 6 to TRL 7 and TRL 8, the following chart has been provided by DECC to illuminate the potentially available options.

The Environmental Transformation Fund (ETI) is shown on the chart below. It is believed that any access to the ETI that is appropriate for SMEC technology will also be found through ongoing contact with the Carbon Trust, to which VerdErg and SMEC are well known.



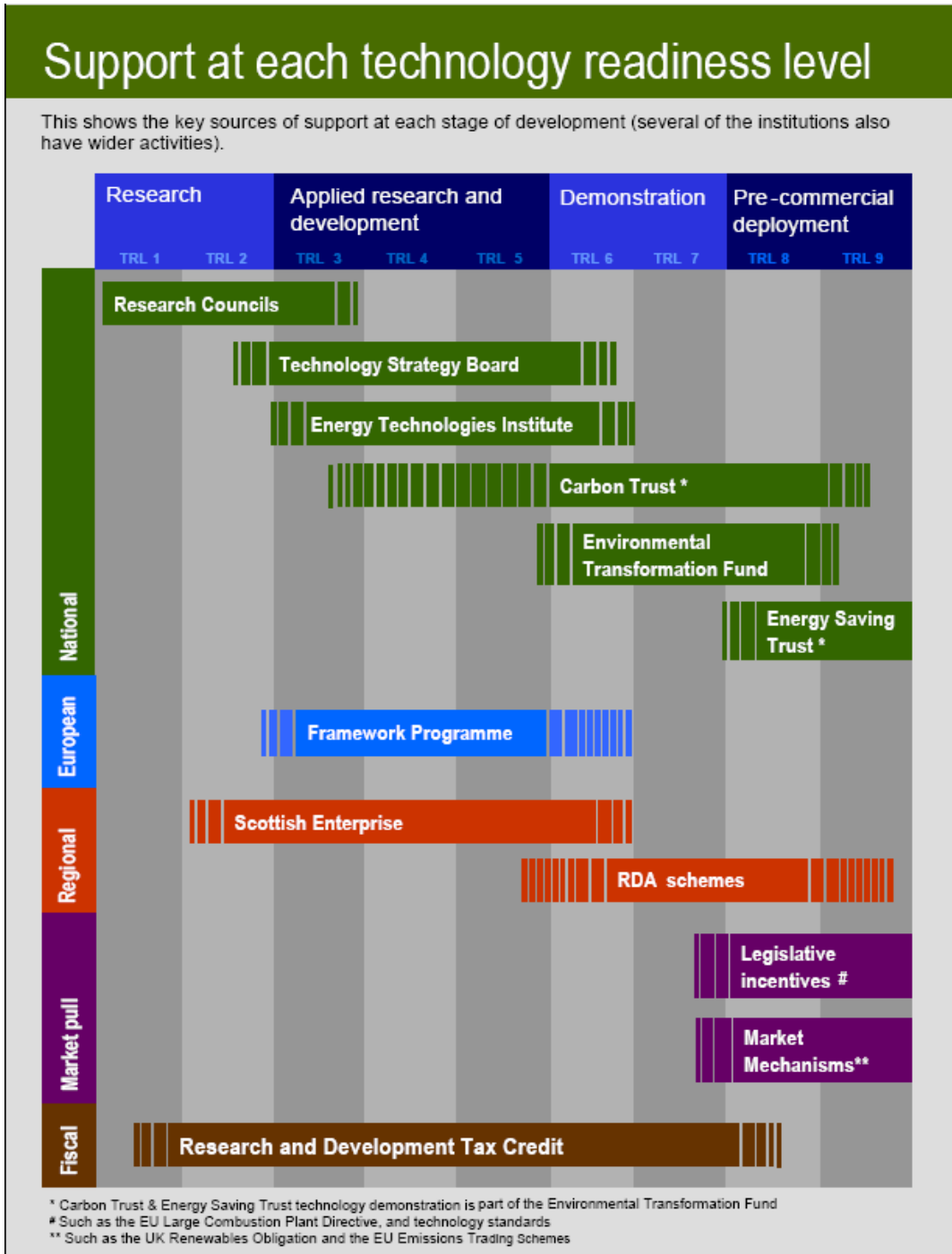

Returning for a moment to the discussion above on DECC's Technology Readiness Level Protocol, it can be seen from the Protocol chart that

	DOCUMENT REF No:  0974-400-PRG-001      Rev. 3
<b>SETS DEVELOPMENT ROAD MAP</b>	Page 34

once established commercially at a modest scale with its technology qualified at TRL 8, SMEC can be judged “Ready for production”.

However, the Road Map includes SMEC’s prior selection for a substantial estuary crossing not quite as wide as the Severn, taking SMEC development beyond TRL 8 by 2020, when the Road Map schedules the technology selections for the Severn estuary.

By 2020 when SMEC technology is available for selection for the Severn Estuary given sufficient Government funding during 2010 and 2011, SMEC will have reached TRL 9, off the scale of the DECC Protocol but in NASA’s original metric at the point beyond technological qualification where operational “Mission Experience” has been gathered.

So although not strictly necessary according to the DECC Protocol, a major estuary crossing was added to the planned experience profile at the end of Work Package 5. This major Estuary crossing which is less demanding than the Severn but still a fully credible platform from which confidence can be gained that SMEC technology is matured sufficiently to be adopted for the Severn Estuary with real “Mission Experience”.

VerdErg does not see these final stages in the Development Road Map from TRL 7 through TRL 8 and TRL 9 to present as large a challenge as getting to complete TRL 6 and through TRL 7, for which Government Grant Funding support is vital.

Conventional Investment funding tends to become competitively available in VerdErg’s experience after reaching TRL 7. Acquiring such additional conventional Investment and Debt funding as may be

	DOCUMENT REF No:  0974-400-PRG-001      Rev. 3
<b>SETS DEVELOPMENT ROAD MAP</b>	Page 35

needed to finance Work Package 5 is included in this Road Map under Work Package 1, above. So the Government funding will be needed primarily during 2010 and 2011, in support of Work Packages 2, 3 and 4. These activities address Key Risks 2, 3, 4 and early elements of Key Risk 5.

The cost of Work Packages 2,3 and 4 will not be known until currently planned discussions described herein complete. It can be characterised in the meantime as of the order of £1 million split between Government and Industrial sponsors.

## 6. SUPPLY CHAIN ISSUES

SMEC technology was conceived to be inherently simple and robust. No new Supply Chains are needed for any materials or specialist equipment that SMEC uses.

The issue is not so much the technological novelty of a SMEC installation across the Severn Estuary therefore, but of its sheer size, particularly if on the Minehead-Aberthaw alignment. The following notes summarise the possible impact on a SMEC across the Severn Estuary of key links in its Supply Chains.

- Structural Concrete.** During a peak year of the fabrication of the Severn Estuary SMEC, the weight of structural concrete used will be approximately 8% to 12% of the annual consumption of the UK (depending on the alignment and based on cement statistics). For such a large project, however, cement can also be sourced from Northern Europe, if not further afield. This is, therefore, a relatively modest demand and is not expected to have a significant impact on either cost or schedule risks. Advance publicity for this huge infrastructure project will in any case undoubtedly encourage

	DOCUMENT REF No:  0974-400-PRG-001      Rev. 3
<b>SETS DEVELOPMENT ROAD MAP</b>	Page 36

manufacturers to plan their production accordingly and encourage planners of other smaller UK and European projects to schedule their concrete consumption demands for different periods.

- **Axial Flow turbines.** There is around 750GW of large hydro-power installed capacity globally and this appears to be growing at around 10GW capacity per year. The Severn Estuary SMEC will require an installed capacity for its conventional hydro-power axial flow turbines of around 1.5GW, approximately equal therefore, to 15% of the World’s annual manufacturing output. This is a challenge if left unplanned but one that is readily accommodated by identifying the turbine sets as “Long Lead Items”, ordering in good time and spreading their procurement over a 2-3 year period, thought to be compatible with the project schedule.
- **Site Preparation.** Significant dredging capacity will be needed for SMEC foundation excavation and levelling. The quantity is around 10-20% of the volume involved with a conventional barrage depending on the alignment, however, which has already been deemed feasible, and is not a particular challenge. The major issue is actually believed to be not so much the size of the task but that a significant part of the work, especially on the Minehead-Aberthaw alignment, lies below 30m water depth which is the limit for many conventional dredging requirements and vessel set-ups. This is not a matter of feasibility but of the normal dredging market being in shallower water. Satisfactory dredging capacity will therefore have to be agreed by negotiation with the dredging Industry, which is notoriously uncompetitive. Robust Project Management measures will therefore be needed to avoid undue price and schedule escalation, but these measures would be necessary when dealing with the dredging industry, even if the work volume was much smaller or the water shallower.
- **High Voltage DC Control equipment and Cabling.** This equipment will be needed in quantities sufficient to service a 1.5GW generation capacity. The equipment, however, is common to any

	DOCUMENT REF No:  0974-400-PRG-001      Rev. 3
<b>SETS DEVELOPMENT ROAD MAP</b>	Page 37

form of power generation plant. The World generating capacity is growing at over 1 Gigawatt per day, so this demand equates to less than 2 days' World output. No supply bottleneck is therefore likely.

The most critical of these items appears to be the supply of conventional large hydro-power turbines, for which appropriate conventional Project Planning measures will be needed to keep their supply off the critical path.

	DOCUMENT REF No:  0974-400-PRG-001      Rev. 3
<b>SETS DEVELOPMENT ROAD MAP</b>	Page 38

## 6.1 Refinements to the Cost of Energy

All the projections and calculations reported by VerdErg in this SETS work responds to what is known or can be reasonably inferred to date about SMEC performance. The Work Product presented deals with what is known about SMEC technology and what needs to be evaluated more fully.

The Procedural Methodology of Technology Development is a niche subject not necessarily familiar to those not directly involved in systematic, planned innovation. The idea of “Unknown Unknowns” is a concept referenced by such Technology Developers but which has attracted bad press coverage when used publicly, out of context, in recent years. Its validity, however, remains undiminished. Like any other Embryonic Technology, there are things about SMEC that we know we don’t know – the Risk Register is the currently updated list of “**Known** Unknowns”. The whole point of the SETS Development Road Map is that it be sufficiently comprehensive for even the “**Unknown** Unknowns” to emerge and be addressed. By definition, we cannot foresee what surprises may emerge along the road for SMEC, as with any emerging embryonic technology. That is why Work Package 5, the progressively larger real installations, is so important.

That said, the pattern of Technological Development beyond TRL 6, the stage which SMEC has nearly reached, is frequently positive. Early first cost estimates are often optimistic but the prototype cost estimates developed under the SETS Programme are typical of such second-stage estimates which are sometimes conservative, and are often improved upon with experience.

	DOCUMENT REF No:
	0974-400-PRG-001 Rev. 3
<b>SETS DEVELOPMENT ROAD MAP</b>	Page 39

It is therefore quite possible that the cost of power produced by SMEC technology will fall to levels below the objective projections presented in this SETS Programme work product. This type of phenomenon is usually referred to as a "Learning Curve" which is another way of saying that the Unknown Unknowns in a Technology Development are frequently amenable to being turned into benefits by a good development team.

An example of the Cost of Energy that SMEC might achieve with time is reproduced below. It shows how the cost of wind energy has fallen with experience and gives hope that SMEC might yet fall to the point where its energy cost will be able to challenge Fossil Fuel directly.

### SMEC – possible future cost advantages

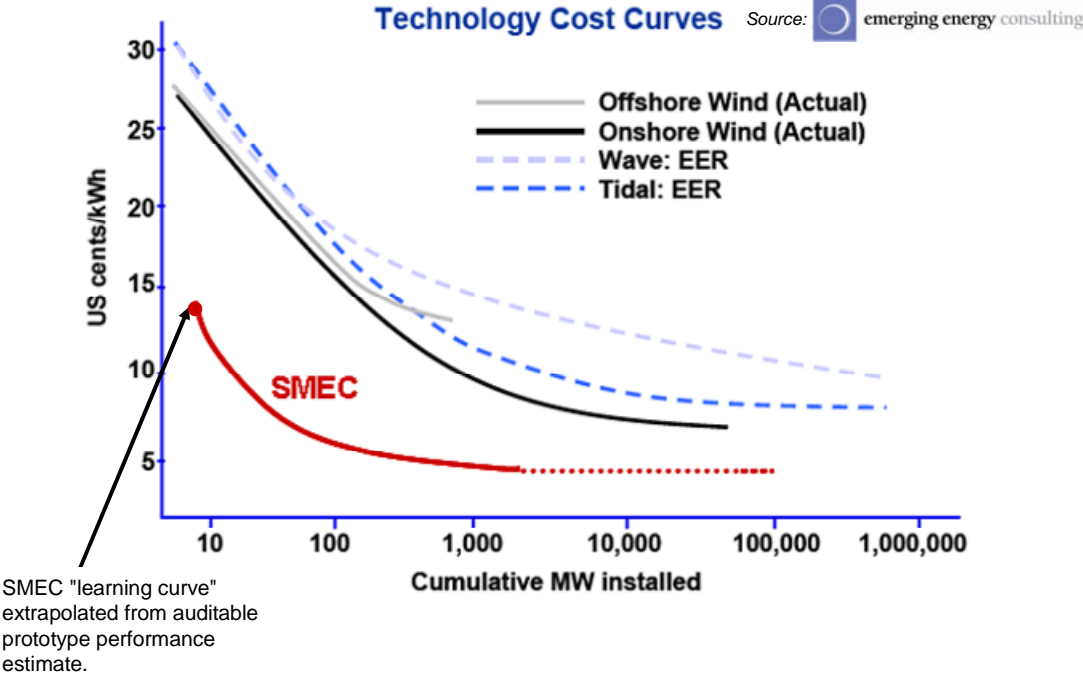

Parity with Fossil Fuel costs is an interesting concept because it highlights an important underlying reality, albeit one lying outside of the scope of this work. Comparative energy prices are an holistic issue

	DOCUMENT REF No:  0974-400-PRG-001      Rev. 3
<b>SETS DEVELOPMENT ROAD MAP</b>	Page 40

as likely influenced by rising Fossil Fuel costs as by falling Renewable Energy costs.

As an example, Natural Gas prices are an important yardstick by which renewable energy costs are judged but have recently broken away from shadowing the equivalent Oil Price and are leading a life of their own at less than half of the equivalent cost of oil. This is because of the introduction to the US market of large quantities of “unconventional” indigenous gas from less prolific, geologically difficult reservoirs. Conventional wisdom has it that this “off-market” low gas price will last until 2015 after which we might expect gas prices to double again and throw all renewable energy sources, including SMEC, into a more favourable competitive position.

With increasing Environmental Awareness moreover, the true cost to the Environment of Energy Generation is likely to increasingly find its way into energy prices irrespective of source, either structurally or through “Green Taxes”. The sort of “Unconventional Gas” now coming to market in the USA as well as much of the World’s coal supply might attract penal cost escalation under this trend. It may also be observed that not all renewable energy sources are equally benign: there is a body of opinion, for example, that regards the visual and noise pollution of onshore wind turbines to be environmentally unacceptable. The competitive position of SMEC could become increasingly attractive in the future as a result of such factors.

Beyond this again is the more fundamental perception that the price paid for gas or coal-fired electricity is a function of the ongoing cost of the hydrocarbon fuel consumed. The price paid for renewable energy, by complete contrast, is largely a function of the cost of servicing the debt raised to build the conversion facility. Admittedly there are also maintenance costs relating to renewable energy generation but most people would agree that renewable energy is “free” once the



	DOCUMENT REF No:  0974-400-PRG-001      Rev. 3
<b>SETS DEVELOPMENT ROAD MAP</b>	Page 41

conversion plant is paid for. The enviable position of those countries with major hydro-power installations supports this view.

SMEC is most accurately described as a “Low-Head Hydro” device. It has much more in common at a theoretical level with hydro-power technology than with current energy devices and this characterisation spreads over into its practical applications. Building a SMEC across the Severn Estuary is analogous to a project like the Hoover Dam, with hugely positive economic and political ramifications that will continue to unfold for a century or more, well beyond the repayment of the initial facilitating debt. The extent to which the cost of the energy it is producing will be “free” in 10, 20, 80 or 100 years time is a direct consequence of the confidence that the international Infrastructure Debt Market has in the integrity of the debt service it expects to receive during the early repayment years. This cash flow projection is a risk issue, of course but one that can be strongly influenced beneficially by the Government if it so chooses, as with Government influence over any major Hydro-Power installation Worldwide. The Risk to the Government of offering some form of passive Sovereign support to underwrite the debt service on domestic Hydro-Power Infrastructure is surely dramatically less than active underwriting of the future international Oil & Gas Price through Fossil Fuel prices, over which no Western Government has much influence any more.

In this respect, the extent to which the cost of power produced by SMEC across the Severn Estuary can continue to fall is at the definitive discretion of the Government, rather than being an accidental consequence of technological Unknown Unknowns or of International Oil & Gas or Coal market price trends.

The paired suggestions that emerge naturally from these considerations are:

	DOCUMENT REF No:  0974-400-PRG-001      Rev. 3
<b>SETS DEVELOPMENT ROAD MAP</b>	Page 42

- That Manufacturing Industry will migrate naturally back to those jurisdictions which are first to achieve high concentrations of mature renewable energy sources developed through privileged access to low-cost Debt.
- That the UK can competitively re-acquire this Manufacturing Industry ahead of the presently emerging nations by Sovereign support of the debt service required in the initial stages of renewable energy infrastructure construction, effectively making future “free power supplies” available to encourage competitively preferential growth of its industrial base.

	DOCUMENT REF No: 0974-400-PRG-001 Rev. 3
<b>SETS DEVELOPMENT ROAD MAP</b>	Page 43

## **APPENDIX 1**

### **1. Scope of Work for CFD modelling of a free-passage gap in a SMEC array**

	DOCUMENT REF No:  0974-400-PRG-001      Rev. 3
<b>SETS DEVELOPMENT ROAD MAP</b>	Page 44

EXTRACT FROM THE SCOPE OF WORK

The context is a river,  $R$  units wide, with a flow of  $F$  units per second with our tidal energy device  $r$  units wide ("SMEC") crossing all or a part of it.

SMEC has streamlined vertical hollow tubes sat on a manifold that joins them together. A linear venturi is defined between each pair of tubes so that, in Sketch 1 where the SMEC crosses the whole river ( $R=r_1$ ), as the water flow of ( $F-f_1$  units) passes between the venturi tubes, the velocity increases in the venturis. The tubes are perforated at the venturi so that  $f_1$  units of water are sucked through a turbine into the manifold, up the tubes and out of the perforations back into the free stream flow of  $F$  units.

Taking power from the turbines creates a head difference between upstream and downstream.

Now, in Sketch 2, a SMEC  $r_2$  units wide is installed part-way across the river. Because of the head difference, a lot of water flows around the end of the SMEC, and relatively little through the SMEC. So  $f_2 \ll f_1$  and not much power is generated. The upstream head difference will dissipate into turbulence, as at a weir, over a very short distance.

In Sketch 3, a SMEC  $r_3$  wide with an end baffle wall is shown, and this time the secondary flow through the turbine  $f_3$  is taken from the by-pass flow. Because we now have a longer flow path (caused by the baffle) between the upstream and downstream heads, and because  $f_3$  of water is being evacuated from this flowpath back into the SMEC, it should be possible to engineer a value for  $r/R$  where the upstream flow  $F$  remains parallel and well-conditioned such that  $r_3/R=f_3/f_1$ .

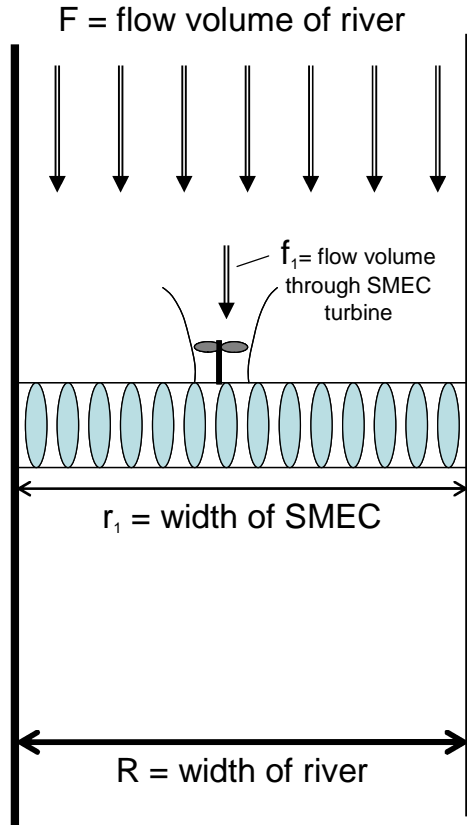

1. Full SMEC across a river.

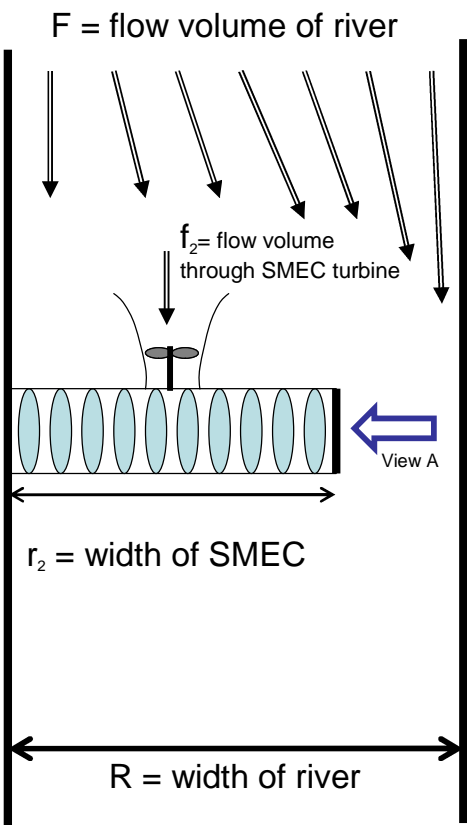

2. SMEC part way across a river leading to heavy bypass flow and turbulence.

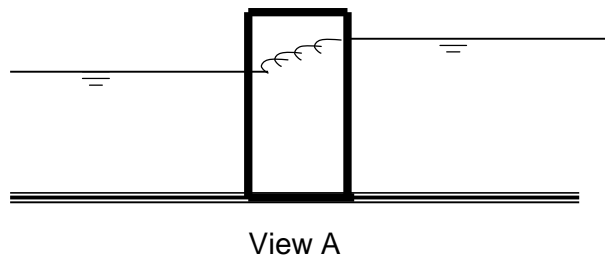

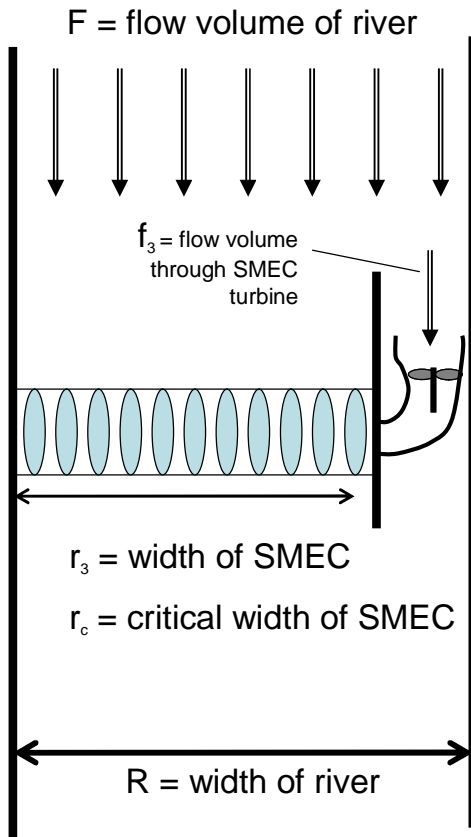

3. SMEC part way across a river with by-pass flow management.

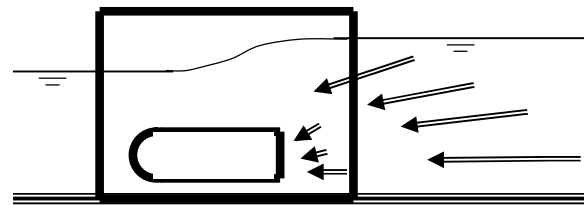

View A

View A



	DOCUMENT REF No: 0974-400-PRG-001 Rev. 3
<b>SETS DEVELOPMENT ROAD MAP</b>	Page 47

## **APPENDIX 2**

### **2. Installation of SMEC into inland rivers**

#### **NOTES ON:**

- The ability to install multiple SMECS in one river
- Corporate Profile of JBA Consulting, a potential collaborator with VerdErg on Work Package 4.

	DOCUMENT REF No: 0974-400-PRG-001    Rev. 3
<b>SETS DEVELOPMENT ROAD MAP</b>	Page 48

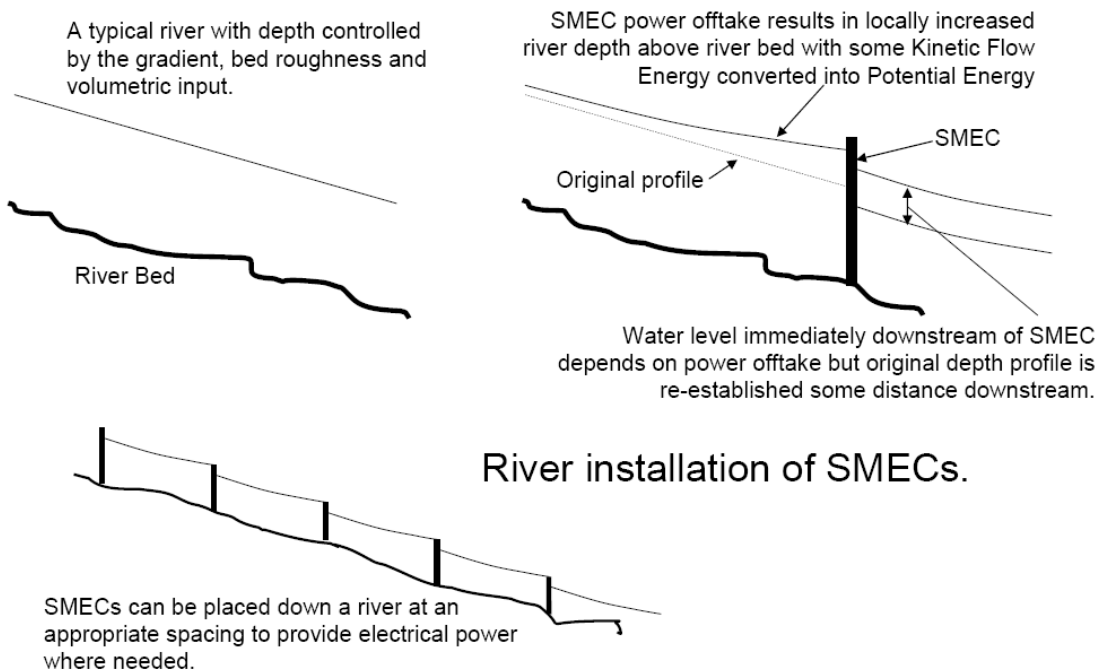

### **Description of JBA.**

JBA is one of the leading hydrological water resources and flood risk management consultancies in the UK, employing over 250 staff and generating close to £10 million of fees a year from this type of work. JBA is a BS EN ISO 9001: 2000 accredited company. In the New Civil Engineer Consultants File for 2007, JBA was ranked the 3rd largest consultant in the UK for flood and coastal work.

Over the last five years JBA has completed over 350 flood risk management and water resources projects for public and private sector clients. Work on this scale demands specialist river analysis skills and knowledge, some of which can only be gained through experience. JBA is one of very few consultants worldwide with the experience of river catchment management and environmental issues at a country-wide scale. The company has built up the environmental, data management, IT, engineering, hydrologist and modelling resources specifically to meet the demands of these large projects. JBA maintains strong links with the UK's environmental and water resources regulators, measurement authorities and also with the academic research community.

JBA has been a flood mapping framework consultant to the Environment Agency (EA) in England and Wales since 1999 and have recently had a Strategic Flood Risk Management Framework contract renewed for a further three years under SFRM2. Of the EA's retained framework consultants, JBA achieved the best Key Performance Indicators for each of the past 5 years.

The company has 14 offices in the UK, Ireland and Belgium with head office in the Broughton Hall Business Park near Skipton, North Yorkshire.



## JBA Consulting



### Services

JBA Consulting provides a range of specialist consulting engineering services covering the fields of:

- ❖ River Engineering
- ❖ Coastal Engineering
- ❖ Scour & flood risk assessment
- ❖ Water quality & sediment transport modelling
- ❖ Digital mapping
- ❖ Database & GIS development
- ❖ Software sales & support
- ❖ Training



### Quality

It is our aim to provide a focused, quality service with an emphasis on personal service. We pride ourselves on our independence and professionalism - we are not a subsidiary of a larger organisation and undertake work for a wide range of clients from government bodies to private firms and universities.

Environment  
Engineering  
Water  
Risk Management

Offices at  
Atherstone  
Doncaster  
Edinburgh  
Haywards Heath  
Limerick  
Newcastle  
Newport  
Northallerton  
Northampton  
Saltaire  
Skipton  
Tadcaster  
Wallingford  
Warrington

### Added Value

JBA is able to offer added value to our clients because of the following:

- ❖ Specialist staff and knowledge of asset management and infrastructure
- ❖ A network of UK offices
- ❖ Our GIS system and UK-wide mapping, flood risk data etc, allows us to complete desk-based assessments providing a more cost-effective service.
- ❖ JBA is a young, innovative firm with low overheads.
- ❖ The company has an excellent track record of completing jobs to budget and to programme.
- ❖ The company is willing and happy to provide all-inclusive fixed prices as an alternative to time charges and target/ceiling costs.
- ❖ Our client base is wide and includes national and local public sector and private sector clients including Defra, the Environment Agency, Scottish Executive, Yorkshire Water, BP and Norwich Union. While our work is predominantly UK based, around 10% of our business is for clients in Ireland and the rest of the European Union.
- ❖ In the March 2009 edition of the New Civil Engineer Consultants File, JBA was ranked in the top five consultancies in the UK for Flooding & Coastal Engineering work. JBA currently employs water resource specialists: hydraulic, coastal and drainage engineers, hydrologists, modellers and environmental experts.

JBA always looks towards the future and we think about our business as we think about the business of our clients. JBA has been successful over the years because we have always exceeded expectations.

Core areas of expertise:

- ❖ Environment
- ❖ Engineering
- ❖ Water
- ❖ Risk Management

We continue to offer outstanding training and industry leading software development.

Info@jbaconsulting.co.uk  
www.jbaconsulting.co.uk

	DOCUMENT REF No:  0974-400-PRG-001      Rev. 3
<b>SETS DEVELOPMENT ROAD MAP</b>	Page 50

### **APPENDIX 3**

#### **3. Carbon Trust MRP application for a small SMEC to be installed at a tidal lagoon site in the North foreshore, Belfast**

##### **NOTES:**

The proposal was not accepted because, it is believed, it was not sufficiently developed. It is included here to show a possible configuration of a small SMEC and to make the point that SMEC can have vertical or horizontal Venturi Tubes as required to suit the site conditions.

**Energy Generation with SMEC**

from the

**North Foreshore Tidal Lagoon**

**Application to the Carbon Trust**

**Marine Renewables Proving Fund**



0	Tender Issued				
	R. Tucker	R. Martins	-	P.M. Roberts	06 Nov 09
REV	PREPARED BY	CHECKED BY	QA REVIEW	APPROVED BY	DATE

© 2009 This document contains information proprietary to VerdErg Renewable Energy Ltd. and shall not be reproduced or transferred to other documents or disclosed to others or used for any purpose other than for which it is furnished without the prior written permission of VerdErg Renewable Energy Ltd.

	DOCUMENT REF No:
	EN 0983-001                      Rev. 0
<b>MRPF Application – Energy Generation from Tidal Lagoons</b>	Page 2

## **TABLE OF CONTENTS**

	<b>Page No.</b>
<b>1.0 ADMINISTRATIVE DETAILS</b>	<b>4</b>
1.1 Project Title	4
1.2 Lead Applicant Details	4
1.3 Partner Details	4
1.4 Additional Partners and Suppliers	5
1.5 Project Costs Summary	<b>Error! Bookmark not defined.</b>
<b>2.0 DESIGN SUMMARY</b>	<b>6</b>
<b>3.0 TECHNOLOGY</b>	<b>8</b>
3.1 Engineering Description of the Technology	8
3.2 Energy Generation Performance of the Technology	13
3.3 Baseline Cost of Energy	15
3.4 Incorporation of Industry Best Practice	15
<b>4.0 DEVELOPMENT ROADMAP AND PROJECT PLAN</b>	<b>18</b>
4.1 Overall Technology Development Road Map	18
4.2 Technology Development Track Record to Date	18
4.3 Fit of Proposed MRPF Project into Development roadmap	19
4.4 Commercialisation Plan for the Technology.	20
4.5 MRPF Project Schedule	21
4.6 Project Scope of Work	21
4.7 Project Cost Estimate	26
4.8 Proposed Grant Claim Schedule	27
4.9 Risk Identification and Management	27
4.10 HSE Credentials	29
<b>5.0 COMPANY AND TEAM</b>	<b>30</b>
5.1 Company Business Model	30
5.2 Financial status	30
5.3 Capacity to Raise Funding	30
5.4 Proposed MRPF Project Funding	30
5.5 Other Information	31
5.6 Additionality	31

	DOCUMENT REF No: EN 0983-001                      Rev. 0
<b>MRPF Application – Energy Generation from Tidal Lagoons</b>	Page 3

5.7	Project Team	31
5.8	Project Team Structure	31
5.9	Relevant Experience	31
5.10	Details of Subcontractors	32
5.11	Accounting & Project Management Practices	32
5.12	Benefits to UK Economy	33

	DOCUMENT REF No:
	EN 0983-001                      Rev. 0
MRPF Application – Energy Generation from Tidal Lagoons	Page 4

## 1.0 ADMINISTRATIVE DETAILS

### 1.1 Project Title

The project title for this application is: “Energy Generation with SMEC from the North Foreshore Tidal Lagoon”.

### 1.2 Lead Applicant Details

**Company name:** VerdErg Renewable Energy Ltd.  
**UK Company registration number** 6968542  
**Address of registered office** 6th Floor, Reading Bridge House, Reading Bridge, Reading RG1 8LS  
**Contact address (if different)** Units 5&6, Lansbury Estate, 102 Lower Guildford Road, Knaphill, Surrey, GU21 2EP  
**Contact name** Peter M Roberts  
**Telephone** +44 (0) 1483 289 300  
**Fax** +44 (0) 1483 289 301  
**e-mail** peter.roberts@verderg.com  
**Name of authorised signatory** Peter M. Roberts  
**Position in organisation** Managing Director

### 1.3 Partner Details

**Company name:** FlowPower Limited  
**UK Company registration number** 06835400  
**Address of registered office** Beech House, 19a Roundwood Park, Harpenden, Herts, AL5 3AB  
**Contact address (if different)** same  
**Contact name** Edward Moore  
**Telephone** +44 (0) 1582 768 894  
**Fax** No Fax  
**e-mail** ed.moore@flowpower.co.uk  
**2<sup>nd</sup> Contact name** Jonathan Slater  
**Telephone** +44 (0) 7714 242 017  
**e-mail** jonathan.slater@flowpower.co.uk  
**Name of authorised signatory** Edward Moore or Jonathan Slater  
**Position in organisation** Partner

	DOCUMENT REF No: EN 0983-001                      Rev. 0
<b>MRPF Application – Energy Generation from Tidal Lagoons</b>	Page 5

## 1.4 Additional Partners and Suppliers

VerdErg and FlowPower have worked closely on this proposal with both Corus and NHT Group as key suppliers of system components. Corus Steel is identified as the primary supplier of steel required for the venturi system in the design. NHT Group are the primary suppliers of the turbine for the device.

The nature of the relationship between VerdErg and both Corus and NHT Group is still under development. It is unclear whether they will join the project as a partner or as a subcontractor. In either case, their participation will functionally remain the same in the project execution plan.

	DOCUMENT REF No: EN 0983-001                      Rev. 0
<b>MRPF Application – Energy Generation from Tidal Lagoons</b>	Page 6

## 2.0 DESIGN SUMMARY

VerdErg and FlowPower Limited are actively seeking to develop a micro-tidal hydropower system using a SMEC technology in the North Foreshore Lagoon in Belfast Council. The North Foreshore Lagoons is a tidal catchment created by the early closure of the council landfill site. Because our proposals create a useful source of green energy from an otherwise wasted site, Belfast City Council have reacted positively to our proposal (Appendix 1). Our expectation is that the council will negotiate and agree to grant VerdErg-FlowPower a long term lease to develop the site.

Initial review of the North Foreshore Lagoon (Appendix 2) shows that the gap in the containment wall between the Lagoon and the Belfast Lough is an ideal location for SMEC technology. VerdErg have developed a low cost version of SMEC ideal for this micro-hydro application. From the North Foreshore Lagoon, SMEC has the ability to generate 300 kW of electrical power. The cost of energy for SMEC, already audited by the Carbon Trust for a 10 MW device, for the North Foreshore was estimated to be the most competitive alternative at ~14 p/kW-h (Appendix 3).

The advantages to the tidal lagoon and future developments are significant:

- Electricity will be available in the populated Belfast area to help meet renewable energy targets.
- SMEC is unobtrusive device that will be nearly invisible as the majority of the device is submerged below the water. Only the generator housing is visible at the side of the lagoon.
- VerdErg-FlowPower already has a portfolio of tidal lagoons in the UK that will allow rejuvenation of these unused tidal areas with the technology demonstrated on this first site.
- The SMEC in the tidal lagoon will be a commercial demonstrator providing valuable data for future larger scale deployment of the



	DOCUMENT REF No: EN 0983-001                      Rev. 0
<b>MRPF Application – Energy Generation from Tidal Lagoons</b>	Page 7

technology. SMEC is currently under consideration for the Solway Energy Gateway, Mersey Develop and the Severn Embryonic Technology Scheme.

VerdErg-FlowPower proposes to perform detailed engineering, fabricate and install a full commercial version of the device. The SMEC will be instrumented to gain real time performance data over its experimental operational period (estimated as 2 years). After vital field data is collected, the device will be de-commissioned and removed if required by the Belfast City Council. In the event that Belfast City Council wish to continue operation of the device beyond this period, arrangements will be made for its sale to an electricity supplier.

	DOCUMENT REF No:	
	EN 0983-001	Rev. 0
<b>MRPF Application – Energy Generation from Tidal Lagoons</b>	Page 8	

### 3.0 TECHNOLOGY

#### 3.1 Engineering Description of the Technology

The Spectral Marine Energy Converter (SMEC) consists of two hydraulic circuits represented diagrammatically in Figure 1. SMEC engages 100% of the tidal stream, with the majority of the stream (approx. 85%) passing through the primary circuit while the remainder passes through the secondary circuit.

The primary hydraulic circuit is the tidal flow passing through a venturi. Within SMEC, the venturi is formed by an array of either vertical or horizontal tubes that are profiled to operate bi-directionally. As the tidal flow passes between the tubes, it is accelerated and a low pressure area is formed. Rows of orifices along the centreline of the tubes put the water inside the tubes in direct communication with the low pressure area in the venturi. Water inside the tubes is entrained into the primary tidal flow.

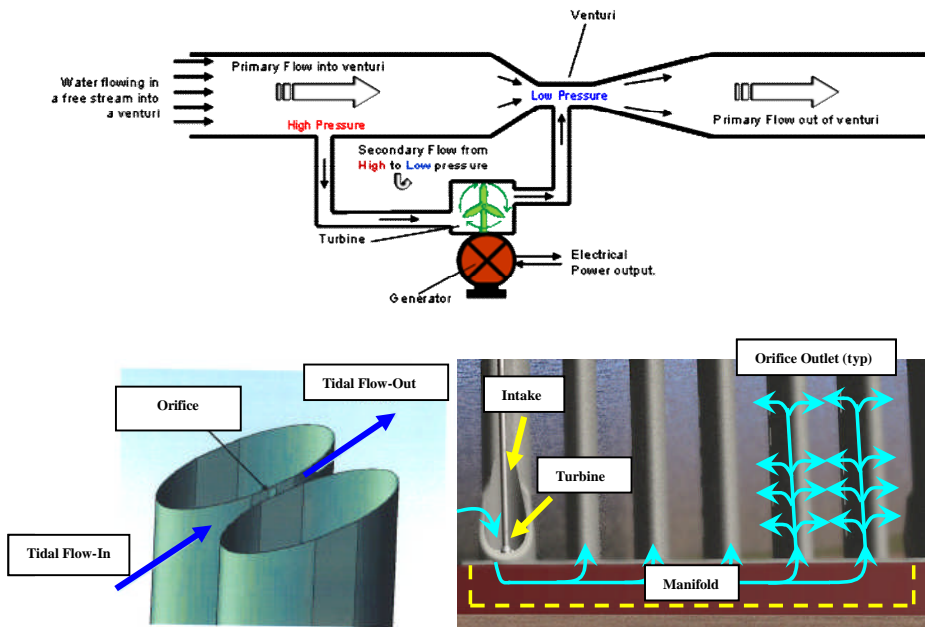



Figure 1 – Diagrammatic Representation of SMEC

The secondary hydraulic circuit is a small portion of the tidal flow that flows internally in the SMEC from the intake to the outlet orifices in the

	DOCUMENT REF No: EN 0983-001                      Rev. 0
<b>MRPF Application – Energy Generation from Tidal Lagoons</b>	Page 9

tubes. After water is drawn into the intake, it drives a turbine to extract power from the secondary flow. After power is extracted, the flow continues along the manifold pipe which distributes water internally to each of the venturi tubes. Water exits the tubes and re-joins the primary flow through the orifices.

For the application of Tidal Lagoons, a micro-hydro version of the SMEC is configured as shown in Figure 2. The horizontal vanes in the SMEC, are shaped to form the venturi pump. The column provides the housing for the turbine impeller below the water, while the alternator and electrical transformers are housed above the water.

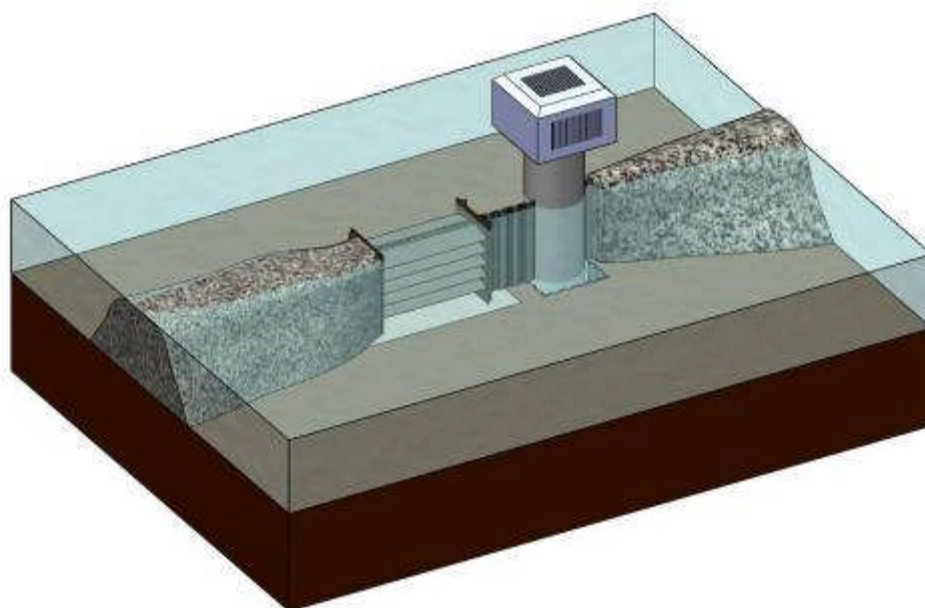
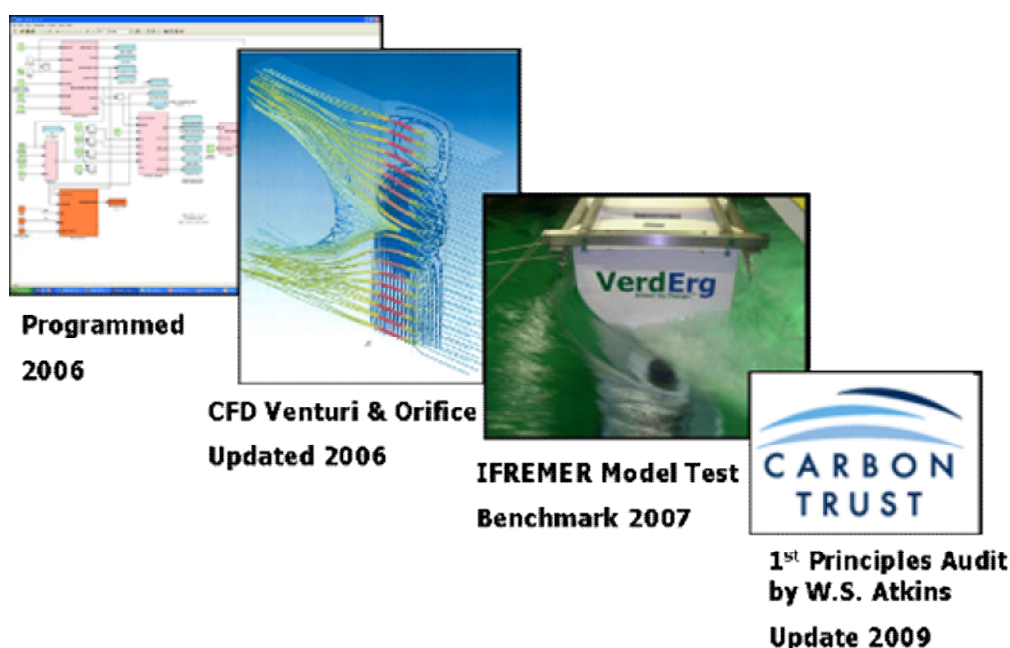

**Figure 2 – SMEC for Tidal Lagoon Applications**

SMEC is a versatile technology that is expected to produce large scale marine renewable energy very competitively with limited Environmental Impact. During W.S. Atkins’ audit of our device for the Carbon Trust , it was classified as being in the important and widespread “Zero to Very Low Head Hydro” market segment. It is thought to probably be the only renewable energy device able to operate in these conditions.

	DOCUMENT REF No:	
	EN 0983-001	Rev. 0
<b>MRPF Application – Energy Generation from Tidal Lagoons</b>	Page 10	

SMEC works in any moving body of water. It is relatively indifferent to tidal range, but its function is mostly defined by average stream flow velocity across the gap. The larger section of slow moving tidal stream is converted to a smaller, higher velocity stream suitable to drive a turbine. Advanced numerical simulations, computational fluid mechanics models (CFD) and tank testing at IFREMER have validated SMEC's performance at the same scale as proposed for the North Foreshore Lagoon.

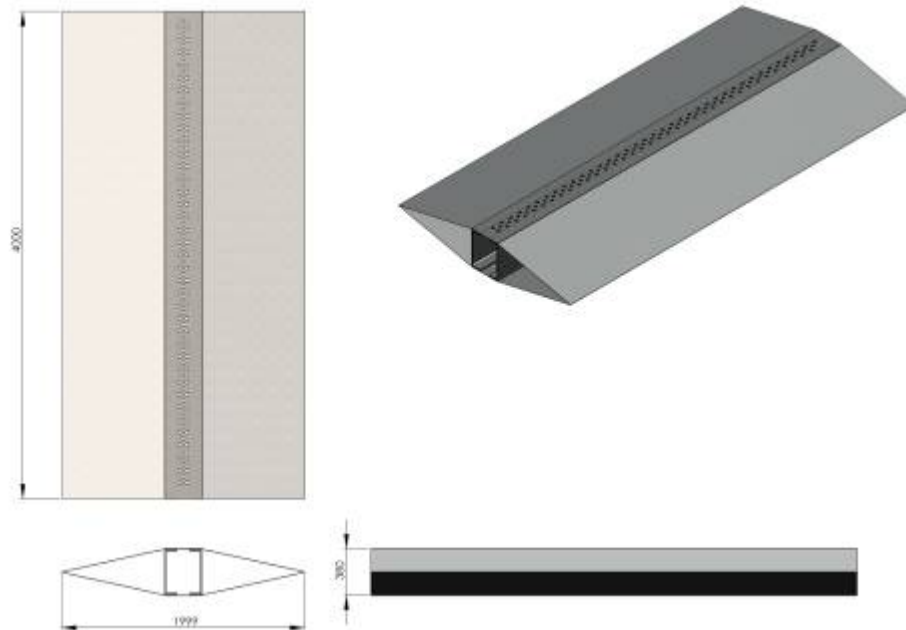

**Figure 3 – SMEC Historical Development from 2006 to Present**

The device for the North Foreshore is a low cost construction designed for a 5 year operating life. The device consists of two primary systems. Firstly, the Venturi vane system as shown in Figure 4 is fabricated from steel plate and beam sections. Corus have been nominated to provide the steel and are developing its price for materials required to fabricate the support box as well as the venturi vanes (Figure 5). This system weighs 6.3 tonnes and is fabricated from low allow carbon steel. It will be pre-fabricated at VerdErg's own assembly facility in Birkenhead,UK, factory acceptance tested and then ferried to the lagoon location for installation. Alternatively, VerdErg will investigate in the context of the project local fabrication near Belfast.



**Figure 4 – Venturi Vane System**



**Figure 5 – SMEC Vane Detail**

	DOCUMENT REF No:	
	EN 0983-001	Rev. 0
<b>MRPF Application – Energy Generation from Tidal Lagoons</b>	Page 12	

The secondary circuit is mostly contained in the power generation column. The intake to the secondary circuit is at the base of the column. As water flows past the bulb turbine, it drives the shaft which is connected to the surface-based alternator. NHT Group in Northern Ireland are currently refining the bulb turbine configuration, and will be the supplier for the turbine and associated ducting. A single turbine is required for the device.

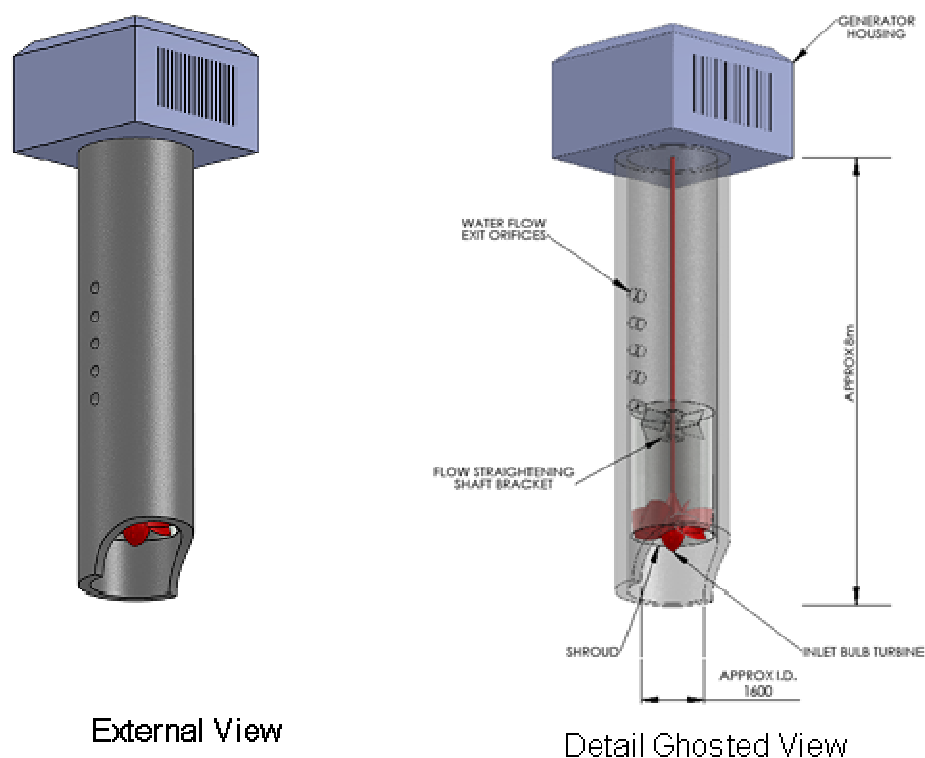

**Figure 6 – SMEC Power Generation & Offtake**

The following makes SMEC distinct and innovative for this application:

- There is no upper size limit to a SMEC, such as happens with turbines or windmills when the blades reach a limiting length. The larger the SMEC, the better. The ideal is for the SMEC to intersect the whole of the flow from bank to bank or coast to coast. This feature coupled to simple materials procured competitively, high reliability, high availability and high predictability of the power supply

	DOCUMENT REF No: EN 0983-001                      Rev. 0
<b>MRPF Application – Energy Generation from Tidal Lagoons</b>	Page 13

results in a low cost of power and gives a real renewable energy alternative.

- VerdErg’s core team of Engineers, Project Managers and Field Personnel has been engineering, fabricating, installing and maintaining offshore hardware for 30 years. See [www.VerdErg.com](http://www.VerdErg.com) for more details. Most of our innovative equipment has been installed under our own supervision into some of the most hostile water globally, lying to the West of Shetland, out in the Atlantic. VerdErg drew on this experience to prioritise reliability and robustness in the conceptual design of SMEC by minimising moving parts subsea, giving high availability for the generating capacity of the SMEC devices featured in this document.
- SMEC responds to the observation that although the energy in a tidal flow can be very large, it typically associates with a large water volume at low head and velocity rather than a low volume at high head and velocity, which would better suit conversion into electrical energy. SMEC was conceived to be a simple, robust and low unit-cost approach to intercepting very large cross-sectional areas of tidal flow to create a high-head, high-velocity, managed secondary flow within its pipework, suitable for efficient conversion into electrical energy. It can be characterised by analogy with a gearbox or transformer.

### **3.2 Energy Generation Performance of the Technology**

Preliminary calculations for the tidal lagoon were developed based on our power generation models. The design may be further optimised in detailed engineering as hydrodynamic testing for the SETS programme is currently underway. These results from BHR Wallingford will be available by December 2009, so they will enable further refinement of the estimates before award of this development.

SIMULINK is a mathematical simulation software that incorporates segments of codes in sub-routines. Due to the linking interactions of

the sub-routines, the system of equations is solved by the iterative engine MatLab that sits in the background of the software. Equations describing the interactions of the primary (Venturi) circuit, secondary circuit, and turbine power offtake are separated into sections in the software as shown in Figure 7.

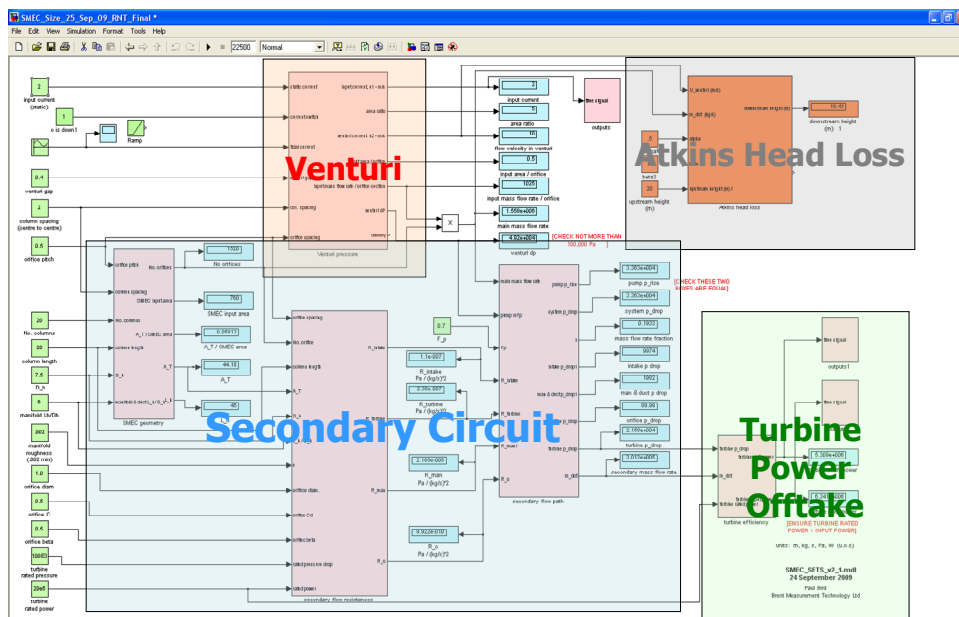

**Figure 7 – SIMULINK Model of SMEC General Arrangement**

Additionally, the Atkins head loss module (Appendix 5) provides a reality check that the amount of power extracted by the turbine lies below the maximum theoretical limit of energy available. Further details of all equations have already been supplied to the Carbon Trust, but these details may be made available if required.

From the available tidal data, a tidal range extends from a maximum (spring) range of 3.4m and minimum (neap) of 1.3m. Assuming an idealised vertical sided basin the potential energy of the enclosed volume of water at high tide, with respect to a datum of the adjacent low tide level, is:

spring – 4560 MJ (mega joule)

neap – 680 MJ



	DOCUMENT REF No: EN 0983-001                      Rev. 0
<b>MRPF Application – Energy Generation from Tidal Lagoons</b>	Page 15

This energy is made available each tide (approximately 12.5 hours), and is therefore equivalent to a mean power of:

spring – 103 kW

neap – 15 kW.

These mean power levels produce average yields of 905,732 kWh (springs) and 132,412 kWh (neaps). Work that has already been performed for the SETS programme demonstrates an annual average 'hydrodynamic' power has a 61% 'water to wire' efficiency. The hydrodynamic parameters affecting this efficiency are the current topic of testing, and will result in improvements in this performance with the updated hydrodynamic data.

### **3.3 Baseline Cost of Energy**

VerdErg have provided a baseline cost of energy based on the 10 MW device as requested. Details of the cost of energy are included in Appendix 4. As attached in Appendix 5, these cost of energy values were audited by W.S. Atkins under the Strand A programme.

VerdErg have therefore estimated the cost of energy for the project as we feel that our original cost of energy estimates were validated by the Carbon Trust audit. Appendix 3 includes a cost of energy estimate specific to the proposed Lagoon device (~14 p/kW-h). A sensitivity analysis also demonstrates the escalation of CAPEX that would be required before matching the average cost of energy predicted by Atkins (~18 p/kW-h).

### **3.4 Incorporation of Industry Best Practice**

VerdErg operates a quality management system (QMS) which has served us well since the company's formation in August 2005 achieving registration with Det Norske Veritas in December 2005 (App 9). Our philosophy has been to keep processes simple in order to ensure processes are consistently applied. Having had limited time to review applicable documentation covering this scope of work our response

	DOCUMENT REF No: EN 0983-001                      Rev. 0
<b>MRPF Application – Energy Generation from Tidal Lagoons</b>	Page 16

may not match fully the client’s quality philosophy. We would, however, expect to achieve a match on successful bid.

Our key document is our Quality Manual, which guides all parties through VerdErg’s interpretation and implementation of ISO9001: 2008 (App 9). The manual links the clauses of the standard to our processes (JP), which are listed in the back of the manual.

Following successful tender and on receipt of a contracts we prepare two documents; a) An Internal Sales Order (ISO), which provides the foundation for contract review, it identifies confirmation of client needs and authorises spend against a project, b) A project quality plan that confirms planned arrangement and quality philosophy of VerdErg and any client specific process variations required. The ISO also doubles as the medium used to identify individual components, quantify and procure them to meet delivery requirements.

Depending upon client requirements we adopt either configuration management of equipment already designed or we design new equipment to client’s new requirements adding them to our range of equipment. The key documents resulting from the design process or required for configuration, also define the controls for the manufacture of equipment. The documents are controlled through our ACCESS database and comprise:

- Parts List/ Bill of Materials (PL)
- Drawings (DR)
- Material Property Data Sheets (MPDS)
- Component Quality Requirements (CQR)
- Engineering Procedures (PR)
- Engineering Specifications (SP)
- Risk Assessments (RA)

Components are procured, via Purchase Orders (PO), from a list of approved suppliers (AVL) against a combination of the above listed

	DOCUMENT REF No: EN 0983-001                      Rev. 0
<b>MRPF Application – Energy Generation from Tidal Lagoons</b>	Page 17

documents included within our PL’s. DR’s and PR’s are used particularly throughout our assembly processes along with RA’s. If not already available RA’s are prepared in parallel with preparation of PR’s and are recorded in our top level PL’s to ensure that Health and Safety (HS&E) is designed into our manufacturing, assembly and test programmes. PR’s are used to define assembly processes and facilitate the performance and documentation of factory acceptance test (FAT) results.

Based on VerdErg’s Quality Plan supplier manufacturing quality plans (SQP/ITP) are submitted depending upon the quality level of items procured and the extent of control necessary. The SQP/ITP’s are issued for our review and approval including any special processes adopted by them. Depending on client approval requirements such documents are issued to the client for their approval.

Following satisfactory manufacture a series of inspection and verification activities are performed depending upon the quality level of equipment. Records are systematically captured, collated, logged on our database and where required by the client delivered as formal Manufacturing Record Books (MRB). MRB’s are stored electronically for all clients and prepared as a deliverable when clients specify the need.

	DOCUMENT REF No:
	EN 0983-001                      Rev. 0
<b>MRF Application – Energy Generation from Tidal Lagoons</b>	Page 18

## 4.0 DEVELOPMENT ROADMAP AND PROJECT PLAN

### 4.1 Overall Technology Development Road Map

A summary of VerdErg’s technology development road map is given in the Figure 8 below. We are currently executing Phases 2a and 2b in our road map within the context of the Severn Embryonic Technology Scheme (SETS). Our objective with the North Foreshore Tidal Lagoon development is to initiate our first commercial demonstrator shown as Phase 2C. Details of the full road map are described in our Commercialisation Plan in Appendix 6.

what we need to commercialise SMEC:

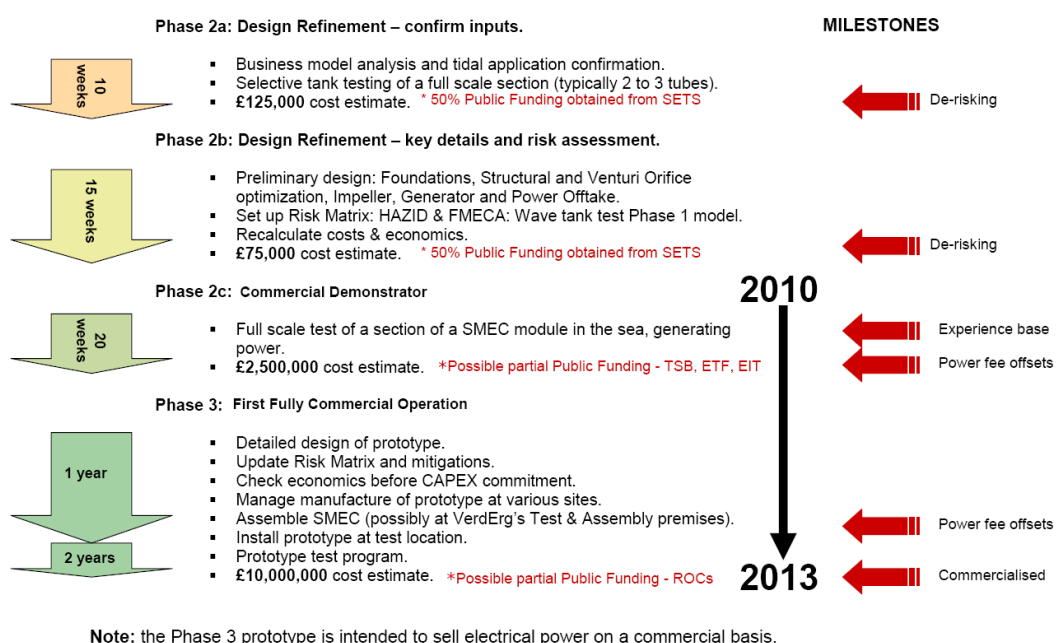



Figure 8 – SMEC Road Map Overview

### 4.2 Technology Development Track Record to Date

The technology development track record to date is included in VerdErg’s Technology Commercialisation plan in Section 5 of Appendix 6.

	DOCUMENT REF No:	
	EN 0983-001	Rev. 0
<b>MRPF Application – Energy Generation from Tidal Lagoons</b>	Page 19	

### 4.3 Fit of Proposed MRPF Project into Development

Our objective with the North Foreshore Tidal Lagoon development is to initiate our first commercial demonstrator shown as Phase 2C. The MRPF application is currently limited to this single location and application.

In the Commercial Demonstrator (Phase 2C) the objective is to install devices of gradually increasing size and power generation capacity. The scaling of the system over a number of lagoons is already under-consideration as VerdErg-FlowPower has a portfolio of 2 additional lagoons and a river application. The North Foreshore lagoon is a necessary first step. The Commercial Demonstrator phase will be considered achieved when a total power capacity near to 2.5 MW has been installed either in a single or multiple locations. A demonstration of how the learning curve may improve costs is shown in Figure 9.

VerdErg

#### SMEC – possible future cost advantages

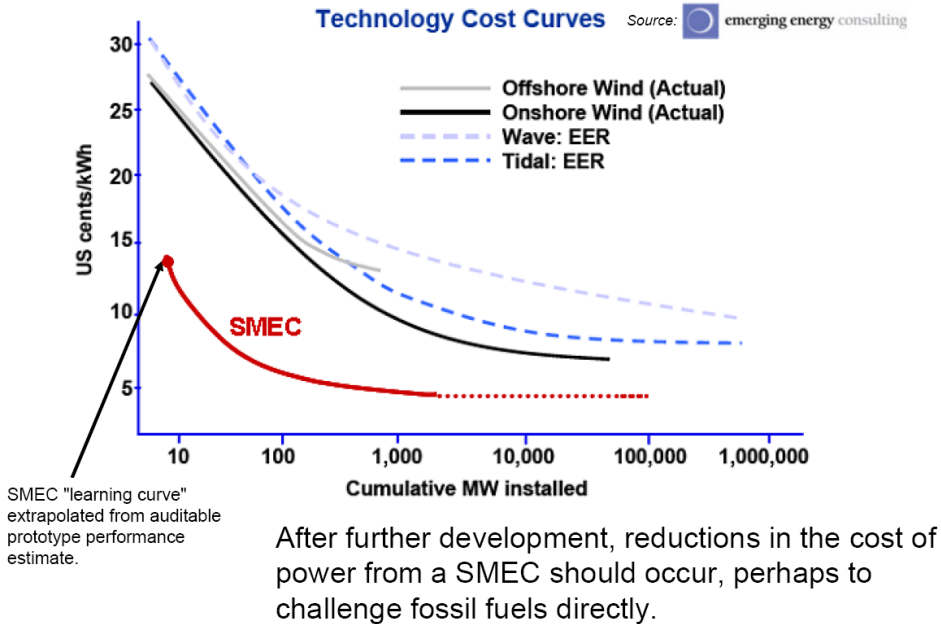

**Figure 9 – SMEC Cost Reduction Learning Curve Analogous to Other Renewable Technologies**

	DOCUMENT REF No: EN 0983-001                      Rev. 0
<b>MRPF Application – Energy Generation from Tidal Lagoons</b>	Page 20

The MRPF is a logical step towards future developments and fits into our road map to 2020. Installing these smaller devices allows the opportunity to validate the cost of energy and refine cost reduction strategies before increasing the scale of the project. As the cost of energy is reduced with more experience, a simultaneous reduction in risk occurs. This will allow our larger projects (such as the Solway Energy Gateway, Mersey and Severn Estuary Concepts) to be realised sooner as confidence is built in the performance and reliability of the system.

#### **4.4 Commercialisation Plan for the Technology.**

Details of the Commercialisation Plan in Appendix 6 include a progressive rate of development and the business plan associated with that. If we are successfully awarded the project, the Belfast City Council has already expressed interest in its implementation.

Risk assessments and description of the system’s environmental impact would be the first necessary steps towards permitting. With the Council’s support, the permitting process is expected to progress as a high pace.

With the technology installed, it will be fully instrumented to collect performance characteristics required for larger scale developments at the first farm stage. A first farm stage device for SMEC would be multi-megawatt due to its effectiveness at converting both the potential and kinetic energy flows. This smaller scale demonstrator would already provide the level of confidence that has been expressed by developers on larger fluvial sites.

VerdErg-FlowPower would then be in a position to explore formalising consortia for execution of the commercial demonstrator. Because of the advances that a field trial would provide, the development timeline for a full scale device of 10 MW would likely accelerate from a 2013 start of design to a 2013 deliver of first electricity.

	DOCUMENT REF No: EN 0983-001                      Rev. 0
<b>MRPF Application – Energy Generation from Tidal Lagoons</b>	Page 21

## 4.5 MRPF Project Schedule

The MRPF Project schedule is under development to the level of detail requested. The total project duration is approximately 14 months to the completion of system commissioning. Limited running and monitoring of the device would continue within the MRPF to the end of 2011.

The system may then be decommissioned if required by the Belfast City Council or may be sold to an operator to continue electrical generation from the site. VerdErg-FlowPower currently expects that the device will continue to operate beyond the limited running window of MRPF and have therefore excluded any costs of decommissioning.

## 4.6 Project Scope of Work

The division of roles and responsibility between VerdErg and FlowPower are as follows:

- VerdErg will provide overall project management and engineering services. This includes providing the technology and supervising its installation and commissioning.
- FlowPower will work as project developer working on site identification, planning/permitting consent from the council, and environmental permissions.

### 4.6.1 Engineering

VerdErg will provide a final design that is safe and serviceable and satisfies the performance specifications agreed with the Belfast City Council. Appropriate analysis will demonstrate that the SMEC device, power grid tie-in and ancillary equipment are fit for purpose. A Design Data Book will be a compilation of all design calculations. Engineering shall be subdivided into the following primary work areas:

- Basis of Design
- Power Generation Estimates

	DOCUMENT REF No: EN 0983-001                      Rev. 0
<b>MRPF Application – Energy Generation from Tidal Lagoons</b>	Page 22

- System Sizing Calculations
- Structural Design
- Foundation Engineering
- Turbine Design
- Electrical System Design
- Safety Systems
- System Instrumentation
- Installation Procedures
- Operation, Maintenance and Repair
- Risk Assessment
- Decommissioning Procedure

During fabrication, traceability of each component is maintained using material movement notes and parts lists. VerdErg shall provide material documents required for shipping of components. This shall include packing configurations, centre of gravity calculations and weight. A Manufacturer’s Record Book shall compile all of the documentation associated with source of materials, part lists, and acceptance test reports.

VerdErg’s engineering team shall actively manage the interfaces to ensure seamless integration of the system. Factory support and installation support will be provided during installation of device, 3<sup>rd</sup> party facilities, during system integration testing, and tie-in and testing.

VerdErg’s primary engineering tool is SolidWorks. Within Solidworks, VerdErg develops its SMEC systems using 3D modelling. The software package is suitable for Bill of Materials analysis as well as basic structural analysis using the COSMOS analysis package.

All of VerdErg’s SMEC systems are analyzed using proprietary structural design spreadsheets and finite element analysis to confirm their



	DOCUMENT REF No:  EN 0983-001                      Rev. 0
<b>MRPF Application – Energy Generation from Tidal Lagoons</b>	Page 23

integrity. Typical analysis performed in a project includes the following:

- SIMULINK Modelling of Power Generation
- FEA of Complete Venturi Assembly during Installation, Operation, Stand-by, and Failure Event Load Cases
- Foundation Engineering for Grading and Sheet Piling
- Installation Analysis Processes
- Fatigue Analysis of Turbine Shaft and Housing
- Fatigue Analysis of Critical Connector Points
- Electrical Offtake Design (Subcontract)
- Structural Steel Welding Qualification Procedures

#### 4.6.2 Procurement

VerdErg subcontract all of the fabrication of individual components. However, our procurement system ensures that we recover ownership of our components after each stage of fabrication. Corus and NHT Group are currently identified as the primary suppliers.

Efficient procurement planning requires that common components are identified and procured in a single block. Therefore, from the approved Design Package, the Product delivery Team develops detailed lists of all individual components to be manufactured or procured, including temporary works, test equipment, facilities and services. These are tabulated for the various elements of the work in Parts Lists.

Procurement responsibilities are allocated to each member of the team. This may be by product e.g. connection hardware, controls hardware; etc., by process type, such as fabrications, machined components etc; or by geographical location. Outputs from detail procurement planning include identification of all items to be procured, bar charts or PERT networks as appropriate, and allocation of procurement responsibility.

VerdErg’s tendering and ordering process is to select potential vendors and have them quote or confirm prior quotations in accordance with the latest market conditions. In the current market, this is allowing us to take advantage of the falling commodity prices.

	DOCUMENT REF No: EN 0983-001                      Rev. 0
<b>MRPF Application – Energy Generation from Tidal Lagoons</b>	Page 24

VerdErg’s vendor approval process includes audits of safety, environmental and quality systems in addition to review of capability, capacity and commercial soundness. Evaluation of suppliers is conducted to a set procedure (JP741). The approval Vendors on VerdErg’s approved vendor list are continually assessed through a combination of expediting and Quality control visits as well as through safety audits and management visits.

#### 4.6.3 Fabrication

Fabrication of key sub-systems will occur at the fabricators site. Integration of the systems will either be validated at VerdErg’s Birkenhead assembly facility or at a site near the tidal lagoon. For current project estimates, the integration of the system is tested in Birkenhead before being deployed to the lagoon.

VerdErgf perform a Contract review with the Vendor at the time of contract award to ensure that the requirements are fully defined, understood, and made clear to the vendor’s project team.

During the manufacturing phase of the Product Management Process, procurement personnel progress the suppliers in their charge, performing site progress visits, and coordinating inspection visits. The kitting lists are updated with a simple visual key to show which elements of the work are outstanding, in progress and completed. Key movements of materiel are also shown. By this simple means, all involved are aware of current status and can readily identify areas for action.

A wide range of reports is used to convey progress and technical information necessary to ensure manufacture progresses smoothly. QA personnel operate the inspection and release system including collation of any Manufacturing Record books that are required. Quality and inspection requirements are set out in the Quality Plan.

Implementation is through site inspectors who inspect and release items against the quality requirements defined in the quality plan.

	DOCUMENT REF No: EN 0983-001                      Rev. 0
<b>MRPF Application – Energy Generation from Tidal Lagoons</b>	Page 25

Inspection and release occurs at appropriate stages through the manufacturing process not just at completion of manufacture. The intent is to catch incipient problems at a time when they can be resolved without impacting the promised end date. Before hardware is released, the inspectors check supporting documentation for completeness and validity. Where appropriate the fact that quality requirements have been met is evidenced by Certificates of Conformity. When product is satisfactory and is released by QA subsequent product movements are authorised on Material Movement Notes (MMNs,) that are issued by procurement personnel to both sender and receiver. The inspectors countersign the MMNs' before release to confirm that the goods and paperwork are satisfactory. Care is taken to ensure that goods are packaged properly for transport, and that transport durations are minimised.

Inspectors submit daily reports of their activities to the Project Team, in which they highlight activities completed and planned, areas of concern and any safety issues that arise. The regular visits of inspector expeditors is the main means by which we will meet our contractual obligation to ensure the vendors are adhering to the safety and quality commitments they make.

Manufacturing records received by the QA team for each purchase order are logged, reviewed and archived. Manufacturing records are considered to be an essential part of any order, and payment for Product will normally be totally or partially dependent on records being received and confirmed to be complete and accurate.

The Manufacturing Records for each project will be collated and issued to the Client in paper or electronic form as required. VerdErg has a Document Management database that is used to keep all the document history prior to hand-over of final documentation to the client.

	DOCUMENT REF No: EN 0983-001                      Rev. 0
<b>MRPF Application – Energy Generation from Tidal Lagoons</b>	Page 26

#### 4.6.4 Factory Acceptance Testing (FAT)

Because VerdErg control the final assembly of the system, Factory Acceptance Testing is also performed at our facility in Birkenhead. Component will be tested in accordance with a pre-approved FAT procedure that has been pre-approved. FAT testing may be witnessed by a 3<sup>rd</sup> party inspector on behalf of the Contractor, and will be notified of testing.

#### 4.6.5 Field Installation

VerdErg will identify and evaluate installation/construction companies for the required civil and installation works. VerdErg will define the installation procedure in accordance with the permit to work so that requirements of the EIA are enforced. VerdErg specialists will be in the field monitoring the installation.

VerdErg regularly provide field support services for integration of connector assemblies into 3<sup>rd</sup> party equipment, verification of correct assembly mounting by checking jigs, system service support during system integration testing, and commissioning support services.

#### 4.6.6 Interface Management

Because of the significant number of interfaces, VerdErg will nominate a dedicated Interface Engineer. The Interface Engineer will coordinate with VerdErg’s Support Services Manager and the Installation Contractor to define the manpower requirements to assist 3<sup>rd</sup> parties in the integration of assemblies into their structures.

### 4.7 **Project Cost Estimate**

The MRPF Cost estimate is currently under development to the level of detail requested. The total project cost is estimated at £890,000. Because of the small size of VerdErg and the nature of the development as R&D, VerdErg have expected to qualify for 80% subsidy to the project. As VerdErg is optimistic of finalising an

	DOCUMENT REF No: EN 0983-001                      Rev. 0
<b>MRPF Application – Energy Generation from Tidal Lagoons</b>	Page 27

agreement with both Corus and NHT group as partners, additional funding will be the source to offset the cost burden to VerdErg-FlowPower.

#### **4.8 Proposed Grant Claim Schedule**

The MRPF Grant Claim schedule is currently under development to the level of detail requested. VerdErg-FlowPower will seek to achieve a cash neutral position through the project.

#### **4.9 Risk Identification and Management**

A Risk Register and Risk Matrix will be set up and preliminary HAZID and FMEA exercises undertaken to identify and then propose, and to subsequently cost out, appropriate mitigation measures.

It may be considered appropriate to invite the Carbon Trust to be represented in this Risk Management Seminar. This is appropriate firstly because of their detailed insight into the Audit undertaken by W S Atkins, and secondly because of the intent to interface with all Stakeholders.

Risks expected to populate the Risk Register will include but will not be limited to the following. This list will evolve as the work progresses, with some topics added and possibly some removed if closure is achieved on one or more risk issues identified below:

**Residual cost and schedule impact of introducing an emerging technology into commercial use.** This is a risk with any technology programme and is best illuminated and calibrated by adoption of a System Development Road Map that complies with the most appropriate International Code of Practice, as is proposed.

**Risks from Laboratory Model to Field Scale.** The work performed under this programme will greatly improve the credibility of power offtake calculations, but the most recent tank tests of a full SMEC module will still be those undertaken in 2007 and in 2009 for SETS.

	DOCUMENT REF No: EN 0983-001                      Rev. 0
<b>MRPF Application – Energy Generation from Tidal Lagoons</b>	Page 28

Amongst the important parameters whose definition will be further improved by this field trial will be:

The consequences if any, of venturi slots becoming exposed as the tides falls. Also, the consequences, if any, of the tops of the venturi tubes remaining open to the atmosphere.

Further study of the behaviour of the water free surface to establish that the transition from the upstream to the downstream elevations, which is a function of the power offtake, is made in a benign fashion. Various flow management strategies for this phenomenon have been conceptually developed by VerdErg.

In a general way, any early stage Commercial Investor without relevant technical knowledge will probably want to see a full-sized SMEC generating useful power. This would be the first available opportunity to satisfy any such commercial requirement.

**Further technical evaluation of the optimal power offtake configuration** (e.g. turbine vs ships’s propeller). This work may reveal that further design work, or even a test programme, is needed to refine the most cost-effective through-life power offtake technology for the range of environmental conditions encountered over the year.

**Combined Wave & Tidal effects.** SMEC will generate power and experience hydrodynamic loading from any incident waves as well as from currents. Only tidal effects are modelled in the work programme and the consensus of opinion remains that any wave effects will be small. Until better defined, however, waves in the lagoon may be considered to pose a residual risk both to structural integrity and possibly to the power generation train.

**Sediment Transport risks.** These will have been studied during the work programme but residual concerns may remain. Regarding sedimentation of the SMEC itself, an electrical cross-connection may be available to permit high-velocity back-flushing to remove any sediment. One possible source of concern regarding the lagoon is that the

	DOCUMENT REF No: EN 0983-001                      Rev. 0
<b>MRPF Application – Energy Generation from Tidal Lagoons</b>	Page 29

blockage of the SMEC structure mentioned above will cause an unacceptable level of sedimentation. This issue will be investigated to the point where an initial understanding can be documented during the work programme.

**Marine Fouling potential impact.** It is probable that marine fouling will occur around the SMEC and possibly degrade the performance. This is a common problem with many marine structures however, and numerous conventional mitigation strategies are available.

**Residual environmental impact** on fish after the design work undertaken is complete. The risk factor of this type thought to be least resolved at the time of writing is the danger to fish swim bladders as they pass through the low-pressure zone of the venturis.

**Compatibility issues of such a large power source with the National Grid.**

There are also a number of **potential commercial risks.** These include further changes in relevant commodity prices and ambient electricity wholesale prices. Also possible is a relaxation of Government Green Energy targets and incentives in the teeth of the current recession.

#### 4.10 HSE Credentials

Integral with our Management System is our HSE and Risk Management processes. Details of the HSE policy are attached in VerdErg’s HSE Manual given in Appendix 8. Also included is our performance statistics for safety at our facilities as well as during installation operations in the field. As the majority of these operations have occurred in harsh environments West of Shetlands, we are very proud of having such a well developed safety culture that results in our low incident rate.

	DOCUMENT REF No:	
	EN 0983-001	Rev. 0
MRPF Application – Energy Generation from Tidal Lagoons		Page 30

## 5.0 COMPANY AND TEAM

### 5.1 Company Business Model

The company will adopt the equipment manufacturer model per the business plan attached in Appendix 6.

### 5.2 Financial status

VerdErg Renewable Energy Limited was recently formed to take over the responsibility of developing the VerdErg renewable energy products. Our core business VerdErg Connectors Limited will be a subcontractor providing our part of the scope of work. This company has 30 years of history in the oil and gas industry. Please find attached in Appendix 7 the last three years set of accounts and current management accounts for VerdErg Connectors Limited.

### 5.3 Capacity to Raise Funding

The following are the sources of funding VerdErg has used to finance the previous development.

	Source of funds	Date	Amount	Type
1	VerdErg	Over two years	£400K	Concept proof activities

Public sources which have provided funding for the development of this technology are included in the following table.

	Proposal title	Recipient	Source	Status
1	Metri II programme – tank test (in kind)	VerdErg Connectors	Ifremer - France	completed
2	SETS	VerdErg Renewable Energy Ltd	DECC and others	Live Project

### 5.4 Proposed MRPF Project Funding

	Source of funds	Amount	Type	Status
1	Carbon Trust MRPF	712K (80% total value of 890K)	Grant	Applied For



	DOCUMENT REF No:	
	EN 0983-001	Rev. 0
<b>MRPF Application – Energy Generation from Tidal Lagoons</b>	Page 31	

## 5.5 Other Information

VerdErg is currently seeking funding for the technology commercialisation in general. The grant would be of critical help to achieve full funding.

## 5.6 Additionality

Without MRPF, VerdErg are unable to self-finance this critical phase of a commercial demonstrator for at least one to two years. It will also greatly improve the chances of attracting funds for the overall commercialisation of the technology. In terms of knowledge, SMEC being a unique concept would help the industry understand an area of tidal energy that is not often researched.

## 5.7 Project Team

	Legal name of organisation	Location	Type	Nature of involvement
Lead organisation	VerdErg Renewable Energy Ltd.	Knaphill, UK	Ltd.	Engineering & project Management (Technology Provider)
Collaborator 1	FlowPower Ltd.	Herts, UK	Ltd.	Project Development

## 5.8 Project Team Structure

Detailed project organisation showing roles and responsibilities is under development. CV's of Key personnel are attached in the appendices.

## 5.9 Relevant Experience

VerdErg has over 30 years experience in the offshore oil and gas industry delivering subsea hardware in harsh and deepwater environments. These multi-disciplinary projects include the same combination of capabilities that will be deployed for our renewable energy developments. This project will represent VerdErg's first renewable energy development in the field using a SMEC device.

	DOCUMENT REF No:
	EN 0983-001                      Rev. 0
<b>MRPF Application – Energy Generation from Tidal Lagoons</b>	Page 32

However, our experience with subsea hardware is attached in Appendix 13 for reference.

## 5.10 Details of Subcontractors

VerdErg maintain a pre-approved suppliers register for its core business, and has procedures for introducing and evaluating new suppliers. For the purpose of this project, primary sub-contracts currently include the following:

- Corus Steel for tubular and plated steel works
- NHT Group for the turbine system

A further sub-contract package is envisaged for electrical offtake systems.

## 5.11 Accounting & Project Management Practices

### 5.11.1 Project Location & Facilities

Engineering & Project Management	Assembly / FAT / Qualification Testing
Lansbury Estate 102 Lower Guildford Road Knaphill, Surrey GU21 2UB United Kingdom	122 Cleveland Street Birkenhead Merseyside CH41 3RB United Kingdom

### 5.11.2 Project Control & Reporting

VerdErg shall provide weekly progress reports during onshore operations, which include: safety, schedule, anticipated completion dates for key stages, next 7 days progress, technical discussion, issues & concerns. A monthly progress report will detail the schedule progress and cost monitoring.

During field operations, daily field reports will be forwarded regularly to the MRFP's Package Manager.

	DOCUMENT REF No: EN 0983-001                      Rev. 0
<b>MRPF Application – Energy Generation from Tidal Lagoons</b>	Page 33

### 5.11.3 Management Procedures

VerdErg’s Management Procedures are indicated in our Quality Manual. All procedures are available for review and audit as required.

### 5.11.4 Documentation

Verderg will manage its document control in accordance with VerdErg’s Quality Management System.

## **5.12 Benefits to UK Economy**

The project has the potential of generating a significant amount of future direct and indirect jobs as well as expanding the knowledge and capability of the tidal energy industry. Currently the UK government have very conservative forecasts of the contribution of tidal energy to reduce CO2 emissions. This concept has the potential to help unlocking the full potential of tidal energy in the UK creating an industry in which the UK has the technological leadership and supply base available.

	DOCUMENT REF No: 0974-400-PRG-001 Rev. 3
<b>SETS DEVELOPMENT ROAD MAP</b>	Page 51

## **APPENDIX 4**

### **4. General information about Woolston New Weir and diversion on the River Mersey**



**Dave Tonks**  
Director, EDGE Consultants  
UK Ltd, Manchester



**Ray Howells**  
Chief Engineer, Manchester  
Ship Canal Company,  
Runcorn, Cheshire



**Roger Bettess**  
Principal Scientist, Water  
Management Department,  
HR Wallingford,  
Wallingford, Oxfordshire



**Mark Morris**  
Project Manager,  
Engineering Support Group,  
HR Wallingford,  
Wallingford, Oxfordshire



# Woolston New Weir and River Mersey Diversion

D. M. Tonks, R. Howells, R. Bettess and M. W. Morris

**The Woolston Weir and River Mersey Diversion project involved provision of a new hydraulic control structure, diversion channel and ancillary works on the River Mersey, near Warrington, for the Manchester Ship Canal Company. The weir is a substantial structure, nearly 80 m wide. It includes the largest low-head, air-regulated siphon weir to date in the UK, with nine bays, each 4 m width, plus 17.8 m wide 'ogee'-type weirs either side, and a fishpass. Design involved extensive physical and numerical modelling. The weir was built in dewatered open cut in difficult ground, within a new channel some 600 m length cutting across an ancient loop in the Mersey. The scheme has provided an economic means of closely controlling a wide range of flows, for flood and navigation purposes, consistent with a pleasant river environment.**

## I. INTRODUCTION

The River Mersey/Manchester Ship Canal system provides drainage to a large area of the North West of England. The upper Mersey joins the Ship Canal south of Manchester and separates again at Rixton Junction, some 6 km upstream of Woolston (Fig. 1). Woolston Weir controls water levels in both the upper Mersey and Ship Canal. Flows of typically 20–40 cumecs, but up to 200 cumecs in flood, pass down the Mersey. Flows in excess of 140 cumecs are routed mainly down the Ship Canal, controlled by parallel operation of sluices at Latchford Locks and Woolston Weir. The systems are integrated to maintain satisfactory water levels in the Ship Canal for

navigation requirements and flood control, under the range of flows.

The 'Old Woolston Weir' was constructed in the 1890s as part of the Manchester Ship Canal works, engineered by Sir Edward Leader Williams.<sup>1</sup> It had 16 gates, mechanically operated to control upstream water levels. This required full time staffing, with quite complex procedures to respond to notice of floods from upstream stations to lower or raise gates accordingly and to liaise with operations at Latchford Locks.

By the 1980s, the weir was nearing the end of its life. Reconstruction or replacement in situ while maintaining operations would have been extremely difficult and expensive. The Ship Canal Company considered this with HR Wallingford, resulting in the proposal for a new 'automated' control structure, using low-head, air-regulated siphons. Several such structures had been constructed (Table 1), including a three-bay siphon on the River Lee at Ware,<sup>2–6</sup> but nothing on the present scale, in the UK. A hydraulic feasibility study, including modelling, showed that it was practical and economic to pass the required flows with a minimal rise in upstream level.

An engineering feasibility study was carried out in 1990–91. The best option was to construct the new weir in the dry, in a channel across an existing loop in the River Mersey. Preparatory works were carried out in 1992. The main construction was carried out during 1993–94, with completion in time to celebrate the centenary of the Manchester Ship Canal.

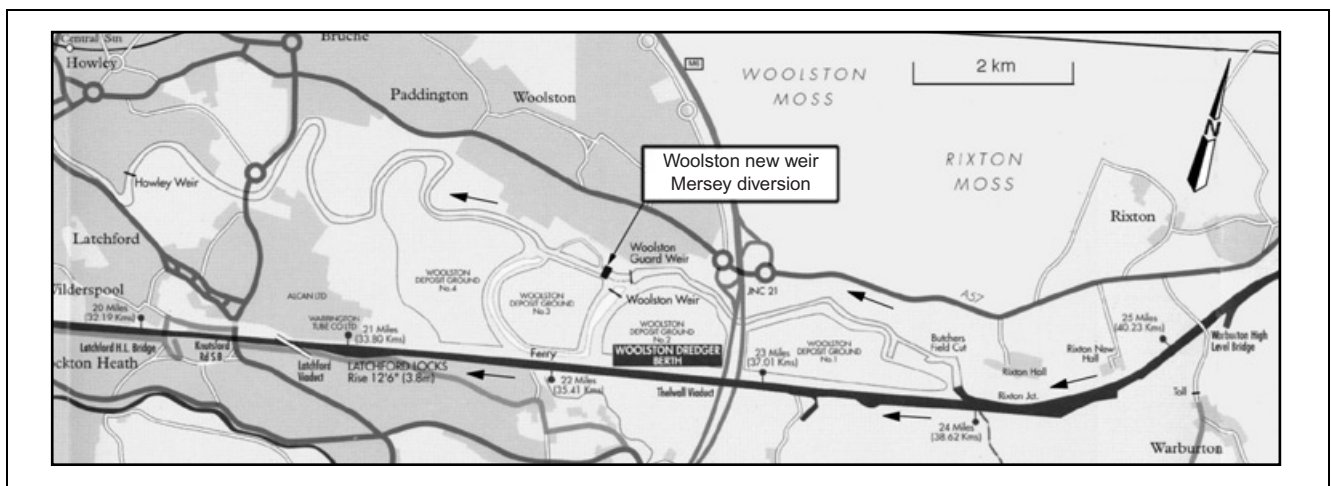

Fig. 1. Plan showing the Manchester Ship Canal, River Mersey and Woolston Weir

Location	Date	No. bays	Dimensions: m	Max. head: m	Peak flow: m <sup>3</sup> /s	Material	Comments
Low-head river siphons							
Wessex Sherborne Lake	1975	3	3.7 × 1.2	2.1	(113)	Concrete	Flood control for lake
River Ouse, Barcombe Mills					45		
River Cray, Hall Place	1970	3			40		
River Bourne, Little Mill	1959	2	1.8 × 0.9	0.8	13		
Anglia, River Welland	1968	2	1.8 × 0.9	0.9		Steel	Reported stress failures
River Gwash, Newstead Mill	1966	1	1.8 × 0.9	0.9		Concrete	
River Welland, Gretton	1970	2	1.8 × 0.9	0.9		Steel	Reported stress failures
River Welland, Tinwell	1970	5	1.8 × 0.9	0.9		Steel	
River Nene, Barnwell	1967	5	1.8 × 0.9	0.9		Steel	Reported stress failures
River Nene, Denford	1968	4	1.8 × 0.9	0.9		Steel	Stress failures lead to collapse. Materials replaced in 1992–93?
East and West Glen Rivers, Flotlado Mill Syphon	1974	1	1.8 × 1.5			Steel	Problems with trash
River Welland, Newborough Syphon	1977	3	2.0 × 1.2			Steel	
River Welland, Four Mile Bar Syphons	1976	3	2.0 × 1.2			Steel	
NRA Thames							
River Lee, Ware Weir	1976	1	3.0 × 1.2	1.1	12.9	Concrete	Reference 4
River Lee, Ware Lock	1977	3	3.3 × 1.2	1.9	63	Concrete	Noise, back venting under hood (van Beesten <sup>2,3</sup> )
River Beane, Sele Mill Siphon	1979	1	3.0 × 1.2	0.6	10	Concrete	
Reservoir siphons							
NW Water	1967–	24	1.5 × 0.8			Concrete	Gives large flow surges downstream
Jumbles Reservoir	71						
Yorkshire Water	1987	2	2.3 × 0.9	2.13	11.2	Concrete	
Mixenden Reservoir						Concrete	
Eyebrook Reservoir	1940					Concrete	
Shin Diversion Dam, Scotland	1957	3 × 2	1.8 × 0.9	≈ 4	85	Concrete	
Dunalastair	1930	2	1.8 × 0.9			Concrete	Modified in 1970s
		2	2.4 × 1.2				
Lubreoch	1958	2	1.2 × 3.8	17	68	Concrete	Priming controlled by valves
Ericht	1953	3 × 2	1.7 × 1.1		102	Concrete	Priming controlled by air valve. Siphons not operated up to 1975

Table 1. Details of some UK air-regulated siphons

## 2. HYDRAULIC DESIGN

The proposed structure had to accommodate flows from typically 20–140 cumecs, to over 200 cumecs in extreme situations (Tables 2, 3 and 4) with minimal rise in the upstream water level. Advances in hydraulic engineering have led to the development of ‘low-head, air-regulated siphons’ which can smoothly pass a wide range of flows with little variation in upstream head. The hydraulics of the new structure, stilling basin and overall system were studied in considerable detail by HR Wallingford.<sup>7</sup> The eventual system consisted of an ‘ogee’ weir each side of a bank of siphon weirs (Figs 2 and 3) designed to match the earlier flow regime, but with improved behaviour (i.e. slightly lower water levels) under flood conditions.

The hydraulic studies included tests using various scaled physical models. A ‘vertical-slice’ model (i.e. section) was used to study siphon behaviour under the range of flows, varying the detailed geometry to obtain the required hydraulic characteristics. The hydraulic behaviour of siphon weirs is

River diversion	Upstream	Downstream
Length	80 m	490 m
Bed level	5.98 m AOD	2.25 m AOD
Low water level	20 m <sup>3</sup> /s 8.1 m AOD	5.5 m AOD
High water level	140 m <sup>3</sup> /s 8.3 m AOD	6.0 m AOD
Max. flood level	240 m <sup>3</sup> /s 9.3 m AOD	8.3 m AOD
Flood banks to	9.8 m AOD	8.8 m AOD
Channel width	50–60 m	50–80 m
Section	Trapezoidal with 1-in-2 slopes	
Weir and stilling basin		
Overall width	76.5 m	
Side ‘ogee’ spillways	2 No. × 17.75 m wide with crest at 7.97 m AOD	
Siphons	9 No. 4 m wide, 1.2 m deep with crest at 8.12 m AOD	

Table 2. Summary of principal hydraulic design requirements

Return period: years	Mean daily flow: m <sup>3</sup> /s
0.25	218
0.5	267
1	304
2	378
5	486
10	583
20	636
50	≈750
100	≈820

Table 3. Manchester Ship Canal/Mersey system at Woolston/Latchford. Flows and return periods

extremely complex, with the rate of air entrainment serving to control the discharge. Design remains beyond the scope of hydraulic theory. Physical modelling is the only reliable means of determining this behaviour and hence of developing a structure design to meet project requirements.

The siphon weir flow passes through four distinct phases: ordinary weir flow, sub-atmospheric weir flow, air-partialised flow and blackwater flow. Fig. 4 shows the siphon model in action (sub-atmospheric weir flow), with the step serving to entrain air which feeds and maintains the siphonic action and hence the flow characteristics. The siphonic nature of the flow results in rapidly increasing discharge for quite small rises in

upstream water level. Key features that affect the performance include

- (a) the inlet shape, throat width and level (relative to crest)
- (b) the underside of the roof/hood profile
- (c) the step, which is critical to priming and the air entrainment process
- (d) the extent of the downstream hood.

Year	Mersey at Woolston Weir*: m <sup>3</sup> /s			MSC Latchford sluices open†	Combined: m <sup>3</sup> /s		Combined peak: m <sup>3</sup> /s
	>25	>50	>100		>200	>300	
1986	183	92	63	14	11	4	140 + 420 = 560
1987	365	206	97	14	15	0	
1988	138	91	61	20	12	1	140 + 230 = 370
1989	273	86	42	13	2	0	
1990	365	145	81	21	2	0	
1991	90	31	19	2	0	0	

\*No. of days showing flows exceeding 25, 50 and 100 cumecs.  
 †No. of days on which Latchford sluices opened for flood control.

Table 4. Analysis of prior flows in the Mersey and Manchester Ship Canal

Van Beesten<sup>2,3</sup> has drawn attention to 'gulping' causing

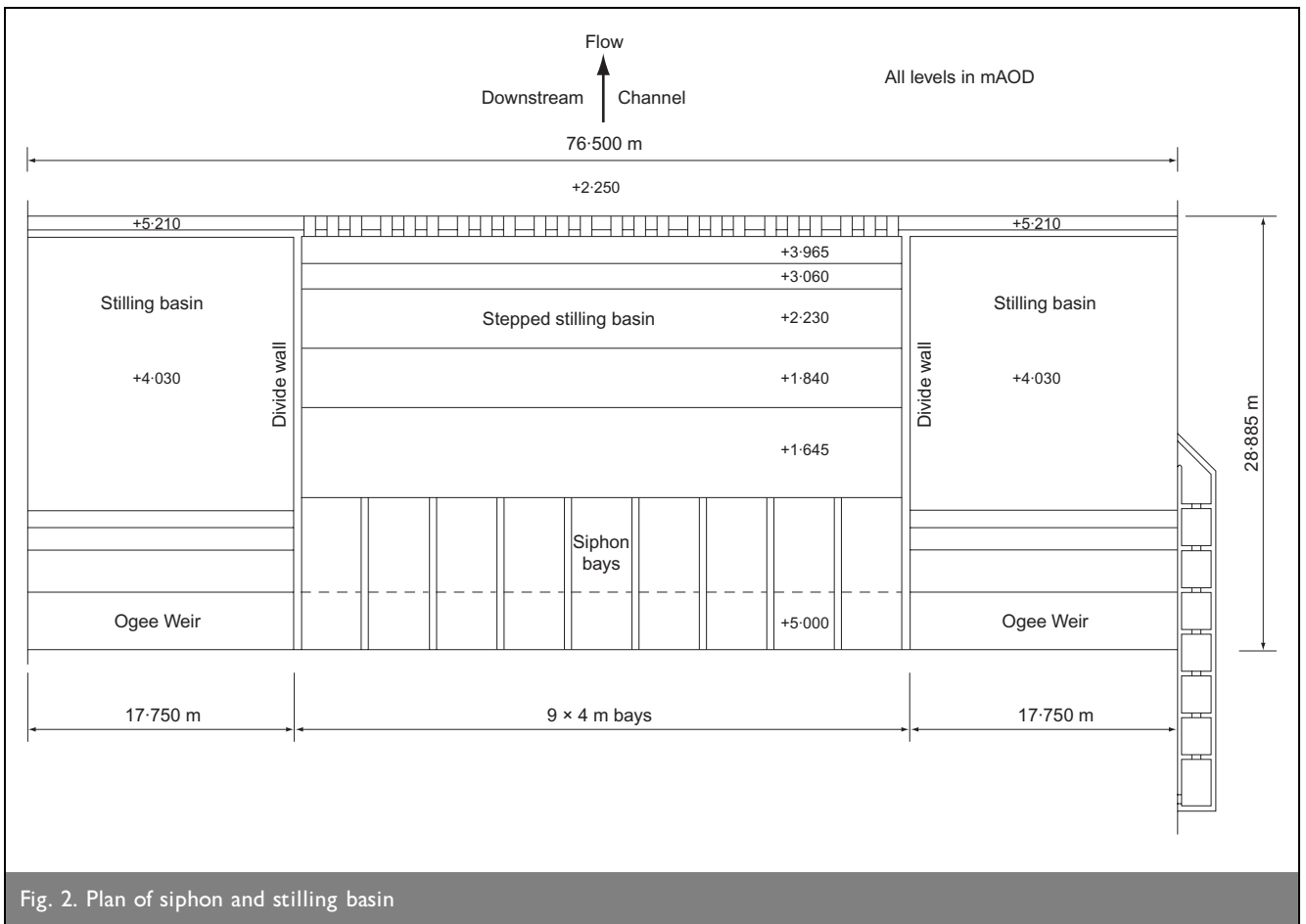

Fig. 2. Plan of siphon and stilling basin

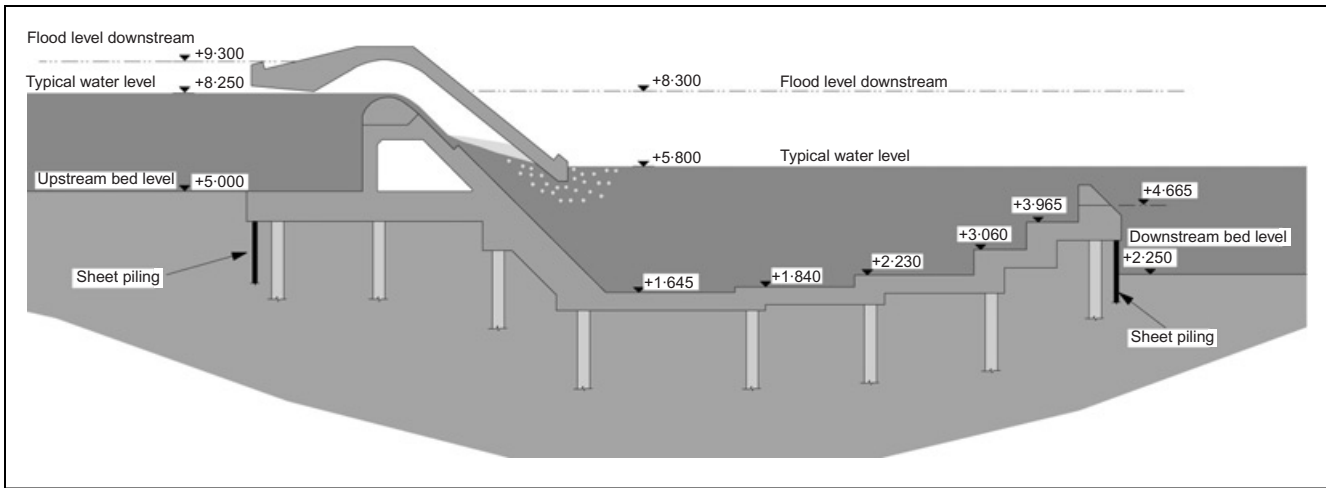

Fig. 3. Section through siphon and stilling basin



Fig. 4. Photo of vertical-slice model in operation

audible bangs and waves upstream as well as downstream in the three-bay siphon weir at Ware, attributed to air entering the siphon from downstream. The present modelling confirmed that the downstream hood must extend sufficiently for the nappe to be well drowned out under all conditions to prevent this.

At blackwater (full siphon action) and above, air entrainment does not occur. Siphon flow can then be calculated from equation (1), i.e. flow proportional to the square root of the head

1	$Q = C_d B H \sqrt{2gh}$
---	--------------------------

where  $Q$  is flow ( $m^3/s$ ),  $C_d$  is coefficient of discharge,  $B$  is crest width (m),  $H$  is siphon throat depth (m) and  $h$  is head (m) across the structure (i.e. headwater–tailwater). Upstream levels then rise quite rapidly, also with an increase in downstream level. Under these conditions the ogee weirs are of particular

importance with flow proportional to head to the power  $3/2$  (equation (2))

2	$Q = C_d B h^{3/2}$
---	---------------------

Downstream tidal effects could have significant influence on siphonic action and particularly the ‘priming’ under some circumstances. This required modelling and design for a complex downstream tidal and surge regime which, in the extreme, could drown out the stilling basin.

Figure 5 shows the horizontal model of siphon, weir, stilling basin and channel used to optimise behaviour of the system including layout, flow mixing, control and erosion protection aspects. This led

also to the design of the detailed geometry for the new channel.

A stage discharge curve (S/D) is shown in Fig. 6, extending the modelling results to 36 m total siphon width to match the required conditions and including the adjacent ogee weirs. The weir crests were set to maintain statutory water level in the Ship Canal for ‘normal flow’. Note the very small increase in upstream level as flow increases from 20 to 200 cumecs, with steadily developing siphonic action. This can be compared with the curves for previous operations—the required water levels having to be controlled by progressive gate operation.

It was important to establish the impact of the proposed structure on the overall behaviour of the canal system. The information from the physical models was incorporated into a computational model (SALMON-F), and calibrated with flow and level data from the canal and River Mersey. In parallel, the Manchester Ship Canal Company was embarking on a project to automate the operation of the sluice gates adjacent to the lock





Fig. 5. Photo of plan model viewed from upstream

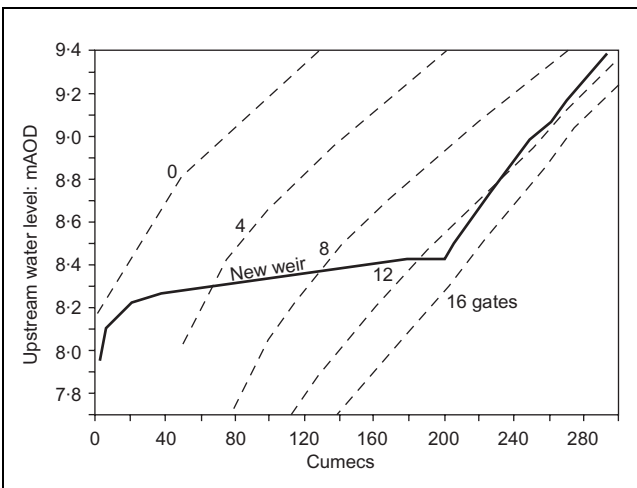

Fig. 6. Stage discharge curves for new system compared to old weir with zero—16 gates open

structures. The hydraulic studies at Woolston assisted with the automation of the control systems, particularly at Latchford Locks.

Downstream of the weir, considerable energy is dissipated with significant erosion potential. Various designs of stilling basin were modelled. The final design creates complex interactions through different flow conditions, but essentially there is always a stable centralised main flow leaving the basin without creating 'rollers'. Even in extremes, downstream velocities do not exceed 2 m/s in the centre channel and 0.8 m/s at the bed and bank. These studies enabled sizeable savings in erosion protection.

### 3. FISHPASS

Water quality in the Ship Canal and River Mersey Basin is being steadily improved by a wide variety of measures. Fish are now present in this stretch of the Mersey and numbers are

increasing. They would not, however, have been able to pass the old gated weir. The National Rivers Authority (NRA, now part of the Environment Agency) requested, and the Manchester Ship Canal Company happily agreed to the provision of a pass for fish and eels.

Studies included hydraulic modelling to assess interaction of flows from the pass with those from the main weir system. The resultant 'pool-and-notch'-type pass will allow fish to climb some 2.5–3 m and provides an interesting feature to the works.

### 4. GEOTECHNICS AND GROUND CONDITIONS

The ground conditions were fairly difficult. The site lies within the Glacial Mersey Valley, where underlying rocks have been scoured out to more than 40 m depth in places. Site investigations included conventional boring, and in situ and laboratory testing. These revealed extensive loose, water-bearing silts and sands, with significant hydraulic heads. Piezocones were particularly useful for assessing the soft and permeable strata. Dense sands and glacial clay suitable for founding piles were typically at 8–10 m depth, with sandstone at 10 to >20 m. Geophysical and hydrographic surveys were carried out for the river closure works.

Stability of the channel slopes and adjacent embankments was critical, under the range of construction and permanent conditions (Fig. 7). Numerous stability analyses were carried out. Design parameters for the various soils are given in Table 5. Crucial to this were the groundwater conditions, including the effects of dewatering, 'rapid drawdown' and subsequently flooding of the new channel. Many piezometers were installed for monitoring and control during construction. The stability of the nearby lagoon embankment was already critical and strengthening measures had to be carried out prior to formation of the channel. The main works were designed to further improve this, with a toe drainage blanket and stabilising berm.

Selection and control of excavated materials for re-use in the various flood protection bunds and closure banks was the key to economic earthworks. Table 6 gives a summary of the main quantities. Some excavated material was used to raise the adjacent deposit ground bank over very weak dredgings using geotextile reinforcement to assist short-term stability—a technique successfully developed for Manchester Ship Canal dredgings elsewhere.<sup>8</sup>

### 5. WELLPOINTING AND TRIALS

Dewatering for the diversion channel was identified as a key

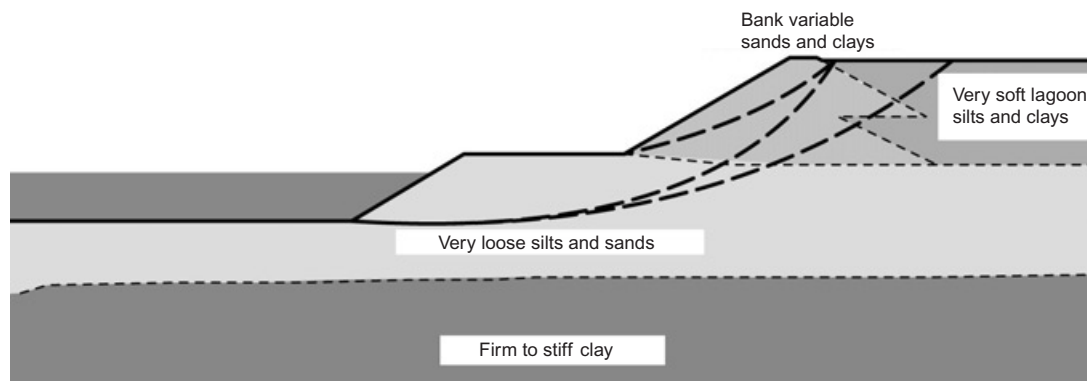

Fig. 7. Cross-section showing typical ground conditions affecting stability

Material	Density	$C_u$ : kN/m <sup>3</sup>	$c'$ : kN/ m <sup>2</sup>	$\phi'$ : kN/m <sup>2</sup>	Comments
Foundation silts and clays	18	20 =0.25 $\rho_o'$	0	28	Existing with consolidation
Foundation silty sands—loose	18	—	0	28	
Foundation sands—m. dense	18	—	0	32	
Dredgings (general soft silts and clays)	16	10 =0.25 $\rho_o'$	0	28	Existing $C_u$ with consolidation
Existing bank materials	18	—	0	28	
Sand fill S	17	—	0	36	
General fill S-F, SF	16	—	0	32	

Table 5. Summary of soil design parameters

Excavations	Length: m	Bed: m AOD	Depth: m	Area: m <sup>2</sup>	Volume: m <sup>3</sup>	Sand: m <sup>3</sup>	Gen. fill: m <sup>3</sup>
Upstream Weir and basin	80	6.0	2.5	140	12 500	0	12 500
	25	1.0 min.	6.5	540	12 500	6500	6000
Downstream	475	2.25	5.5	330	180 000	60 000	120 000
Total	580				205 000	66 500	138 500
Fills							
Bunds							
Upstream north	110	9.8	2.0	13	1400	1400	
Upstream south	75	9.8	2.0	13	1000	1000	
Downstream north	520	8.8	1.5	9	3700	3700	
Downstream south	455	8.8	1.5	40	57 700	57 700	
W closure D/S	210	8.8	1.3	7	1400	1400	
Total	1370				65 200	65 200	
Closure bunds							
East closure	85	9.8	9	240	14 000	12 000	2000
West closure	75	8.8	6.5	160	8000	6000	2000
Raising no. 3 bank	445	22.0	5.5	83	52 000	13 000	39 000

Table 6. Summary of main earthworks quantities

risk factor. Groundwater had to be lowered from near-surface to about 6 m depth, over an area some 600 m long by 50–80 m wide. There would be considerable delays and costs if draw-downs could not be quickly established. Complex adjacent groundwater sources included the river at either end, a raised

permanent tie-backs were taken via the reinforced concrete slabs to short anchor sheet piles behind.

Structural design of the siphon and hood was dominated by complex dynamic pressures. Model testing with transducers

lagoon to the south and an ancient navigation canal to the north.

A wellpointing trial was instigated, with a 40 m square of wellpoints at 2 m centres, to 7 m depth operated with various pumping combinations over three months. Extensive monitoring confirmed that single lines of wellpoints on either side of the excavation were practical and economic, and draw-downs would not have significant influence outside the site boundary. The wellpoints were suitably located for the main works and handed to the contractor, so that the cost of the trial was defrayed. As a result, the difficult construction dewatering was economic and without significant problems or delays.

## 6. STRUCTURAL DESIGN

The weirs and stilling basin are surrounded by substantial permanent sheet pile walls, taken down to cut-off in the boulder clay, designed to also provide temporary support to the excavation during construction. Larssen 32 W sheet piles were used to meet the substantial bending moments. They were propped off the base slabs. At the crest, per-

showed large pressure variations on both the crest and the hood, from about 3 m (30 kPa) positive head to -5 m (-50 kPa) suction, varying over microseconds. Very random behaviour was found, without scope to set up natural frequencies or patterns of oscillations on the rigid concrete structure. Computer analyses assessed the reinforced concrete under the range of operational forces. There were reports that a steel siphon weir had shaken itself to destruction (see Table 1). The analyses indicated that the natural frequency of such a structure in steel could well be within the frequencies to be expected, whereas for this concrete structure they were of a different order of magnitude.

The weir profiles required some complex curved shapes to tight tolerances ( $\pm 6$  mm) dictated by hydraulic requirements, with difficult upper surfaces. It was concluded that the required quality was best achieved by precast units cast inverted, designed to be fixed in place, to very tight tolerances. The system involved final shimming into exact position, then grouting up, with large bolts (M11s) taken through to the voids below. The main body of the siphon weir was therefore designed hollow to allow access for securing the crest units and also to reduce loadings (Fig. 3). Precasting was also considered for the complex shapes of the siphon structure roof. However, moment continuity was desirable for rigidity and damping against the dynamic stresses. The aesthetics of the structure were also given much attention. Fluted concrete faces were specified to mimic the sheet piling profile. Dytap panels were chosen for the siphon roof, to match nearby erosion protection.

Piling was required to support the weir and stilling basin loadings. This also proved more economical than increasing the dead-weight to withstand uplift. Conventional 275 mm square precast concrete piles were used, with 60 tonne working loads, driven to set at around 10 m below the base of the stilling basin and verified by static and dynamic testing.

## 7. CONSTRUCTION

The works were carried out under a conventional ICE 6th Edition Contract for a tender sum of around £2m with a contract period of 62 weeks. Tables 7 and 8 summarise the costs and programme, respectively, for the main items of work. Fig. 8 shows the works during construction in the summer of 1993, with the weir and stilling basin in dewatered excavation around 6 m deep and the newly excavated channel a few months before flooding. In the foreground is the upstream River Mersey, guard weir and the old Woolston Weir evidenced by turbulence downstream. The Manchester

	Cost: £k
Site investigations and studies	80
Preliminary works, drainage and dewatering trial	50
Site preparation and prelims	50
Wellpoint dewatering.	180
Earthworks 200 000 m <sup>3</sup> (including bunds, disposal and re-use)	570
Deposit ground no. 3 general fill	130
Stilling basin concrete	300
Weirs concrete	260
Piling	40
Sheet piling	280
Temporary works including dewatering	100
Erosion protection	220
Monitoring	30
Drainage	40
Roads, footpath, fencing, services, etc.	20
Miscellaneous/other	90
<b>Total</b>	<b>£2.1m</b>

**Table 7. Summary of main costs**

Ship Canal (top-left corner) runs nearly parallel to the Mersey.

Although before the advent of CDM, considerable attention was given to health and safety in design as well as construction. The client had extensive in-house experience as owner and operator of the many Ship Canal structures and also as the navigation authority. Risks were designed out where possible. In particular, the siphon structure avoids the need for the inherently risky manual operations and maintenance of gates. Construction in a dewatered cut avoided most of the risks of over-water working. The weir was designed with as clean and simple operations as

Task	Commenced	Duration
Feasibility studies	1989-90	1 year
Consultations	1990	4 years
Preliminary designs	February 1991	5 months
Site investigations	March 1991	3 months
Hydraulic physical and computer modelling	March 1991	18 months
Wellpoint trials	May 1992	8 weeks
Detailed design	March 1992	8 months
Tenders issued	18th December 1992	6 weeks
Construction programme	March 1993 to May 1994	62 weeks
Preparatory earthworks mounds etc.	22nd March	4 weeks
Sheet piling	19th April	5 weeks
Wellpointing structure	17th May	3 weeks
D/S channel wellpointing, rip/rap, etc.	17th May	9 weeks
Guard weir refurbishment, footbridge	16th June	4 weeks
Precast piling	18th June	4 weeks
Central stilling basin slab	27th July	7 weeks
Fishpass	1st August	8 weeks
Central stilling basin slope	4th August	6 weeks
N/S walls/basins	6th September	5 weeks
U/S channel wellpoints rip/rap etc.	8th September	9 weeks
Weir precast blocks	19th October	2 weeks
Siphon hood	22nd October	12 weeks
Planting	1st November	3 weeks
Upstream and downstream breakthroughs	4th May 1994	8 weeks

**Table 8. Main design and construction activities**



Fig. 8. Aerial view of the works during construction (from upstream)

hydraulic requirements allowed. Considerable emphasis was placed on safety during the construction stage and the contractor's procedures were commendable.

Figures 9–12 show the siphon during construction and operation. Fig. 9 gives an impression of the massive downstream face, prior to the hood being formed, with some precast crest units in place. The concreting sequence was quite involved, with nine similar bays for the siphon weir. The critical path ran through these activities, which had to be well advanced before water could be allowed into the new channel adjacent to the structure. Logistics of the steel-fixing, formwork, pours and striking times for the siphons, plus many other sections of weir, stilling basin and fish-pass proved quite demanding. Reinforcement was heavy in places, particularly in the more difficult areas of siphon walls and roof. The construction programme involved over 100 pours up to 140 m<sup>3</sup>, many of complex shapes, with a total of over 5000 m<sup>3</sup> of concrete.

A high-quality, geotextile-formed (Zemdrain) concrete finish was specified for the weir concrete, giving decreased water-cement ratio and improved durability. The awkward curved profiles were novel, but after some experimentation with trial panels (then used as quality standards) an impressive concrete

surface quality was achieved. The step in the lower face was made of stainless steel, in view of the fairly harsh environment and difficulty of replacement.

In the downstream channel, erosion protection was provided by vegetation where possible, including shallow water margins formed just below water level, planted with reeds. Rip-rap, where necessary, was placed on geotextiles, typically 2 mm thick, 600 g/m<sup>2</sup>. In erosion-sensitive areas reinforced grass was used, pre-sown close to operating water levels. Adjacent to the weir, 150 mm thick Dytap panels were specified, consisting of stone in concrete blocks, 410 kg/m<sup>2</sup>, with continuous

stainless steel cable ties, formed into flexible articulated panels. A reddish-brown colouration was chosen to match the sandstone of the Mersey Valley. The downstream channel was broken through to the existing river in October 1993 and the channel left to 'bed down' over winter.

## 8. BREAKTHROUGH AND OPERATIONS

In early summer of 1994 the upstream channel was broken through. Mersey flows were controlled over the next year by operation of the old weir and guard weir to allow the new system to settle and vegetation to become established on the banks, before running the siphon up to blackwater flows.



Fig. 9. Siphon during construction, viewed from stilling basin before formation of hood



Fig. 10. Fishpass, construction near complete

The weir has now been operating satisfactorily for over five years and gives a good match with design expectations. As expected, there is some 'lapping' noise from the upstream openings, reflecting the prime/break cycles, but this is not excessive and is well screened. There are also perceptible 'reflection' waves travelling upstream from the openings. Each bay acts slightly differently in this, due to minor construction and natural variations. With a wind shear gradient on the upstream surface the higher side tends to prime first. These details are considered desirable as they give interference and damping of the pressure effects.

#### 9. ENVIRONMENTAL AND COMMUNITY ASPECTS

The site lies in a pleasant local amenity area used by the local population for walking and bird watching, with a nearby SSSI managed by a conservation group. The Mersey Valley and river

water quality are being steadily improved; environmental considerations have featured accordingly. The new weir and fishpass provide interesting features. Landscaping bunds were formed at the start of the works to screen construction from nearby housing. An 'environmental channel' approach<sup>9</sup> was taken to design, with an ancient meandering channel rehabilitated to create an island for wildlife, areas of wetlands and water margins planted with reeds.

The works necessarily involved consultation with the NRA, the local authority and the community generally. A noise assessment was carried out with consultations before construction, with suitable controls on piling and some other operations. The client, contractor and consultant cooperated in keeping the local community well informed, including a display and explanatory video, resulting in good relationships throughout the works.

A wide range of planting was specified, including screening between footpaths and wildlife/bird-watching areas and elsewhere wildflower mixes, designed to promote species diversity. The final scheme has created a pleasant amenity area with space for nature and leisure, in har-

mony with important flood control works.

#### 10. CONCLUSIONS

The new Woolston Weir provides modern, effective flood control measures on the Manchester Ship Canal/Upper River Mersey system. The weir automatically controls flows of up to 140 cumecs, with less than a 200 mm rise in upstream water level. Higher flows, up to 700 cumecs or more, are passed in combination with the adjacent Ship Canal sluices, automated by telemetry, tuned in accordance with the computer and physical modelling.

The scheme has proved economic and effective and is a tribute to the many who worked hard on its design and construction. It was constructed on time and within budget and entailed



Fig. 11. View of weir from the south, near complete. Upstream erosion protection in progress

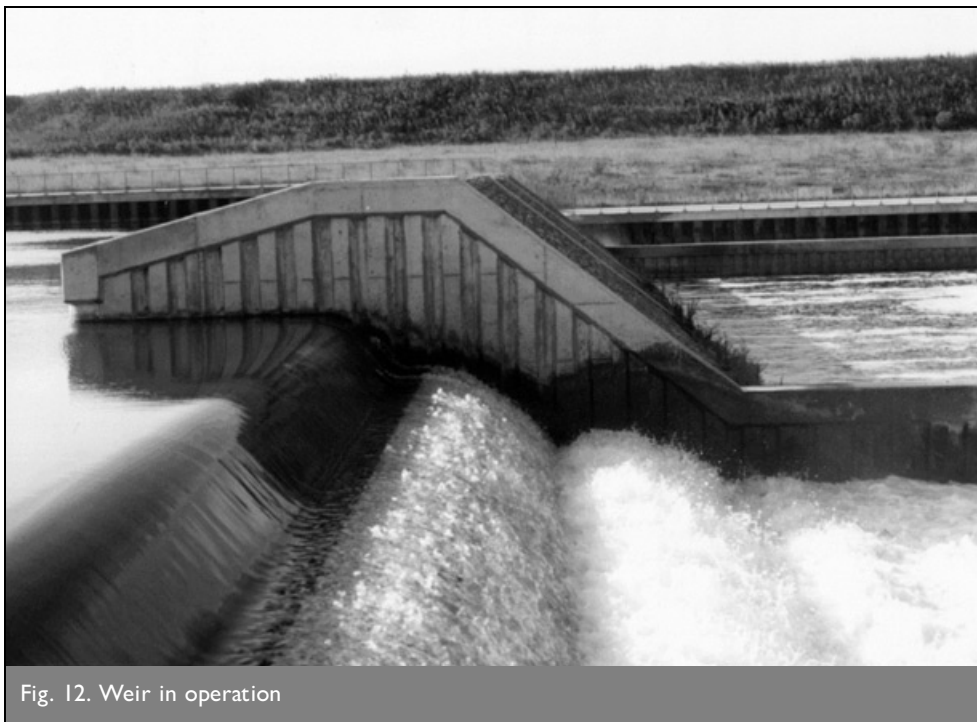

Fig. 12. Weir in operation

interesting and innovative work for all the main parties involved.

The weir is performing well and in line with the design expectations. It is also an attractive structure, blending well with the area and contributing as a feature.

## 11. ACKNOWLEDGEMENTS

The authors are pleased to acknowledge the contributions of numerous people from the project team and many interested

parties, including local authorities and the then National Rivers Authority. Particular mention should be made of the following: Manchester Ship Canal Company. Assistant Chief Engineer (Design), Mr David Ogilvie. HR Wallingford, Fishpass Specialist, Dr Eric Whitehead. Manstock Geotechnical Consultancy Services Ltd, Professor Peter Rankilor. Resident Engineer, Mr Mike Partridge. Assistant Resident Engineer, Mr Dilwyn Parry. Morrison Construction Ltd (contractor): Project Director, Mr Graham Charles; Contracts Manager, Mr Roger Chapman; Site Agent, Mr Tom Stainton. Wellpointing, W. J. Engineering. Sheet piling, Dews. Piling (driven concrete precast), Bachy.

## REFERENCES

1. LEECH B. *History of the Manchester Ship Canal*. Sherratt and Hughes, Manchester, 1907.
2. VAN BEESTEN C. The application of a siphon spillway for river flood control. *Proceedings of the Symposium on Design and Operations of Siphons and Siphon Spillways*, BHRA, Cranfield, 1975.
3. VAN BEESTEN C. Hydraulic structures in flood control systems. *Proceedings of the ICE, Civil Engineering*, February 1992, 30–38.
4. HEAD C. R. Low head air regulated siphons. *Proceedings of the ASCE*, 101, ASCE Hydraulics Division, 1975.
5. ACKERS P. and THOMAS A. R. Design and operation of air regulated siphons for reservoir and head water control. *Proceedings of the Symposium on Design and Operations of Siphons and Siphon Spillways*, BHRA, Cranfield, 1975.
6. MORRIS M. W. The role of computational and physical modelling in river management and flood control. *Proceedings of the International Symposium on Management of Rivers for the Future, November 16–18*, Department of Irrigation and Drainage, Malaysia, 1993.
7. HR WALLINGFORD. *Woolston New Cut and Control Structure*.

Report ex 2758. HR Wallingford, Wallingford, March 1993.

8. TONKS D. M. Woolston trial embankment for waste deposit lagoons. *International Reinforced Soil Conference*, BGS, Glasgow, 1990.

9. HR WALLINGFORD. *Handbook for the Hydraulic Performance of Environmental Channels*. Report SR490 (draft). HR Wallingford, Wallingford.

Please email, fax or post your discussion contributions to the secretary: email: [lyn.richards@ice.org.uk](mailto:lyn.richards@ice.org.uk); fax: +44 (0)20 7799 1325; or post to Lyn Richards, Journals Department, Institution of Civil Engineers, 1-7 Great George Street, London SW1P 3AA.

	DOCUMENT REF No:
	0974-400-PRG-001 Rev. 3
<b>SETS DEVELOPMENT ROAD MAP</b>	Page 52

### Record of Amendment

COMMENT FROM	DATE	REFERENCE	NOTES
PAD	29 Jan 10	Rev1	No amendments.
PAD	24 Feb 10	Rev2	Minor amendments to text and headings.
P. Roberts	01 Mar 10	Rev 3	SMEC technology development Road Map program updated.

2	Issued to SETS Board				
	P.M. Roberts	R. Tucker	-	R. Martins	26 Feb 2010
1	Issued to SETS Board				
	P.M. Roberts	R. Tucker	-	P.M.Roberts	29 Jan 2010
0	Issued for Information				
	P.M. Roberts	R. Tucker	-	P.M.Roberts	25 Jan 2010
REV	PREPARED BY	CHECKED BY	QA REVIEW	APPROVED BY	DATE