

CHAPTER 23

MORTAR RANGES

INTRODUCTION

2301. **General.** A mortar range needs little, if any, permanent construction. Selection of the range and preparation of the firing points (mortar line) by the mortar detachment may be all that is required. However, on permanent training ranges it may be advantageous for some permanent construction to be undertaken.

2302. **Training Area Status.** The status of the training area for firing mortars depends on the ammunition nature:

- a. **HE and Smoke.** These may only be fired on a designated range authorised in accordance with Reference A (Volume I).
- b. **Para-Illuminating.** This may be fired on a designated range or on military training areas subject to the approval of the RAU.

2303. **Aim.** This chapter describes the facilities that may be constructed on a mortar range and in particular:

- | | | |
|----|--------------------|-------------|
| a. | Introduction | 2301 - 2303 |
| b. | Range danger areas | 2304 - 2306 |
| c. | Construction | 2307 - 2310 |
| d. | Communications | 2311 - 2312 |
| e. | Maintenance | 2313 |

RANGE DANGER AREAS

2304. **Weapon Danger Area Templates.** The currently approved WDA templates for Light and Medium Mortars are shown in the Figures to this Chapter. The conditions for applying the templates are set out in Reference B (Pamphlet 21). However, the overhead mortar fire safety template (Figure 23-9) can only be used on ranges that permit this type of training (see Reference B (Pamphlet 21)). Any deviation in applying the WDA templates will require approval from HQ Infantry.

2305. **Topography.** At extreme ranges the difference in height between the firing position and the target has to be taken into account (see Reference B (Pamphlet 21)).

2306. **Impact Areas.** Refer to Chapter 2.

CONSTRUCTION

2307. **Siting.** The area selected for a mortar range has to contain the WDA and should be large enough to exercise the mortar platoon in fire and manoeuvre using, ideally, the maximum range of the weapons. The ADH and the requirement for notification as stated in Chapter 1 will need to be considered. In woodland, there must be sufficient muzzle clearance over the full arcs of fire at the mortar line.

2308. **Targets.** There are no specific targets for mortar ranges. They may be physical features, simulated defensive positions, figure targets or vehicles. The target area should be firm and dry ground to reduce the number of blinds.

2309. **Mortar Fire Controller Positions.** Mortar fire controller (MFC) positions on PTR may require prepared observation posts (OP) and surfaces for AFV.

2310. **Mortar Lines.** Tactically, mortars will be positioned 40 m apart but this may be reduced to 10 m if space is restricted. A permanent mortar line may require pre-positioned mortar positions and prepared sites or hides for AFV mounted mortars.

COMMUNICATIONS

2311. **External.** A means of summoning the emergency services, ideally a land laid telephone, is to be available.

2312. **Internal.** Radio or telephones must be provided between the RCO, MFC, mortar lines and range control. Permanent ranges will normally have their own range safety network.

MAINTENANCE

2326. Little maintenance is necessary on a mortar range. Constructed positions, such as MFC and dug-in firing positions, require to be inspected and kept in a safe state. Clearing undergrowth, dead wood, litter and debris reduces the fire risk.

Not to Scale
Not to be Copied

Reference: W
D/AG/TS/9/2/3/2/ dated 9 Sep 97

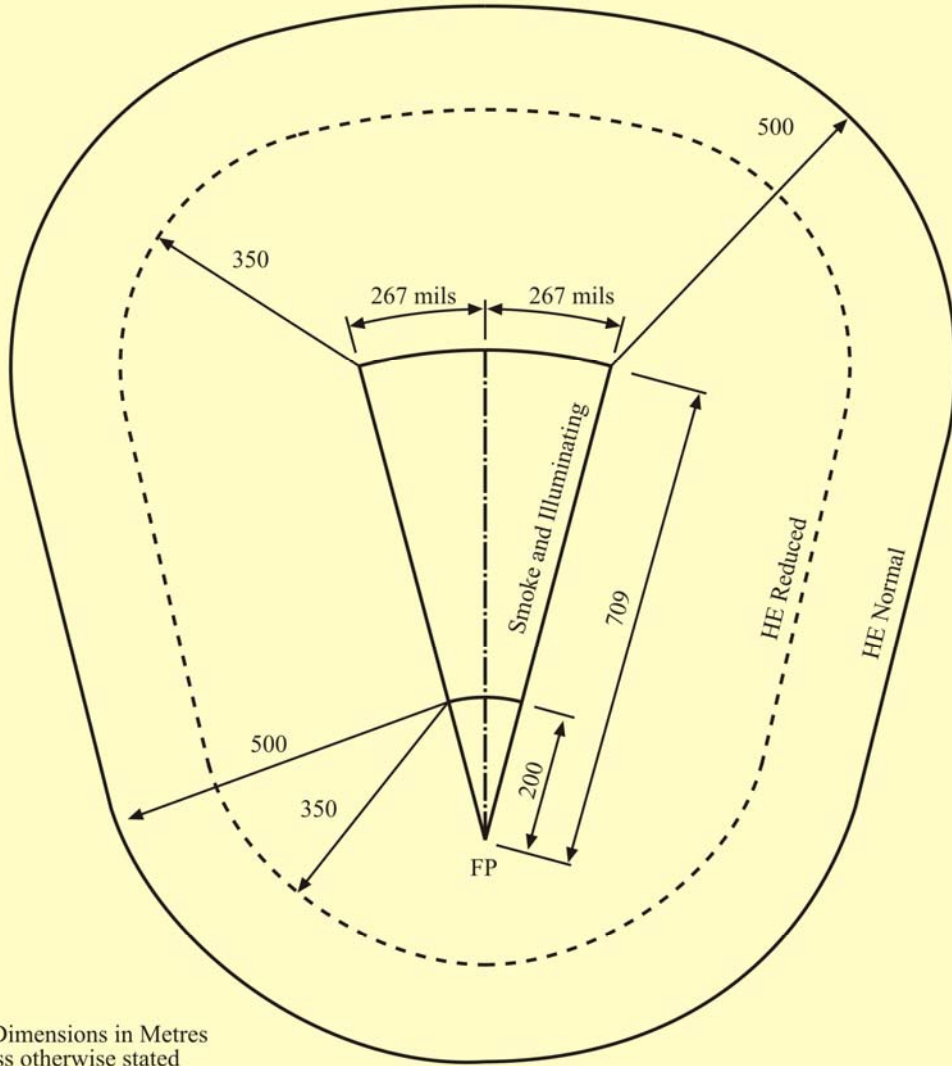

All Dimensions in Metres
unless otherwise stated

ADH: 1000 ft AGL.

Figure 23-1. WDA Template, 2 inch Mortar

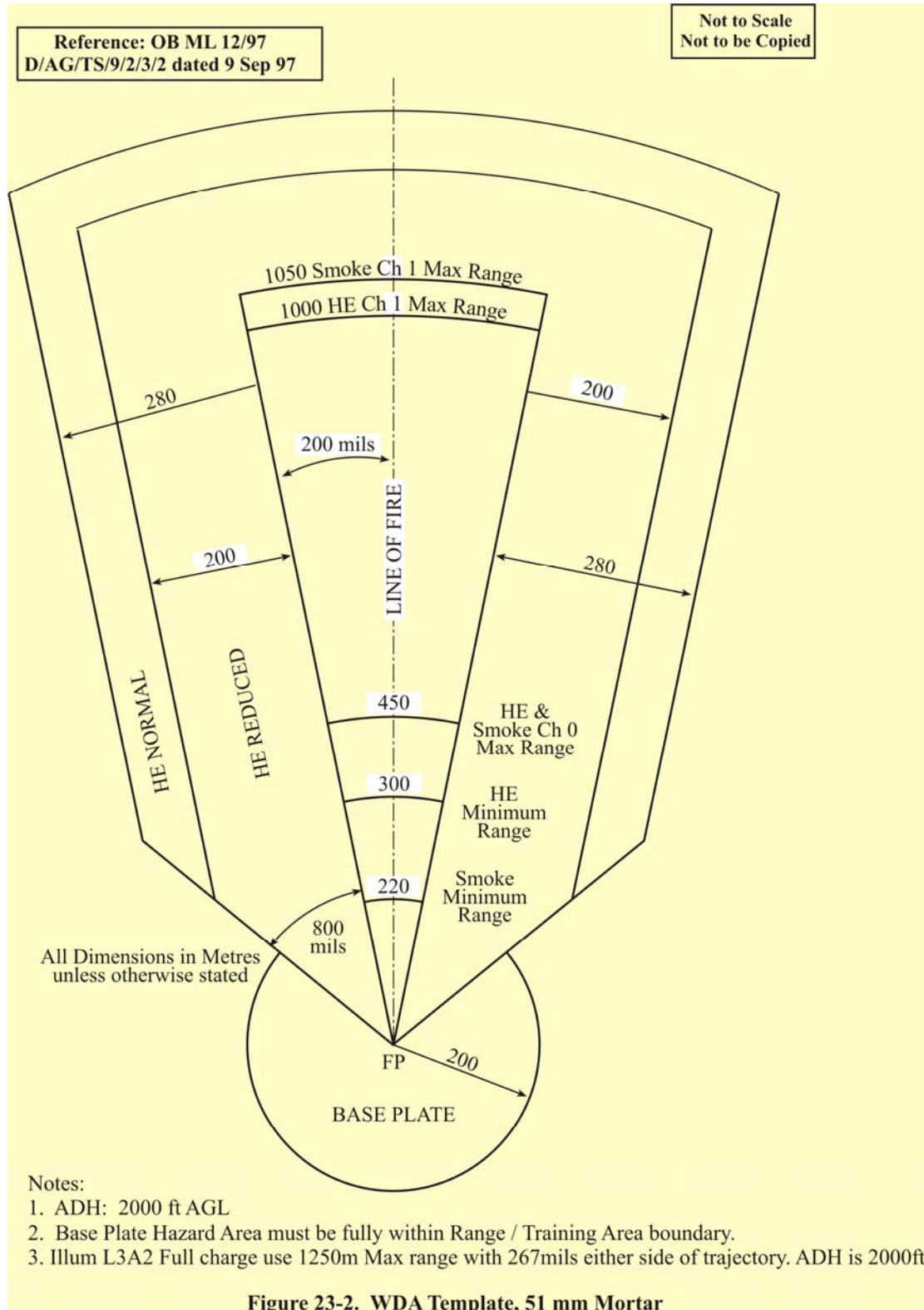

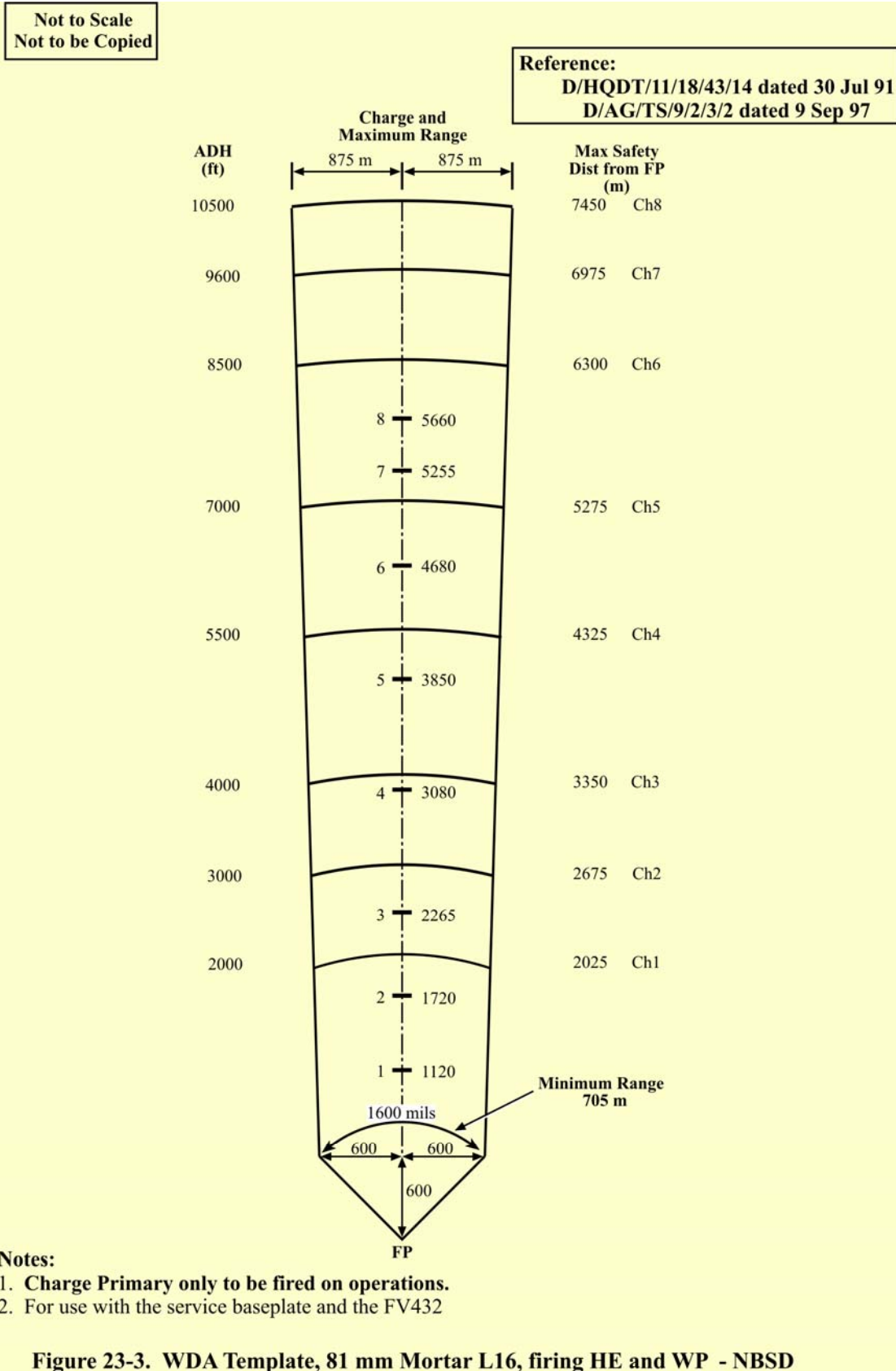

Reference:
D/HQDT/11/18/43/14 dated 30 Jul 91
D/AG/TS/9/2/3/2 dated 9 Sep 97

Not to Scale
Not to be Copied

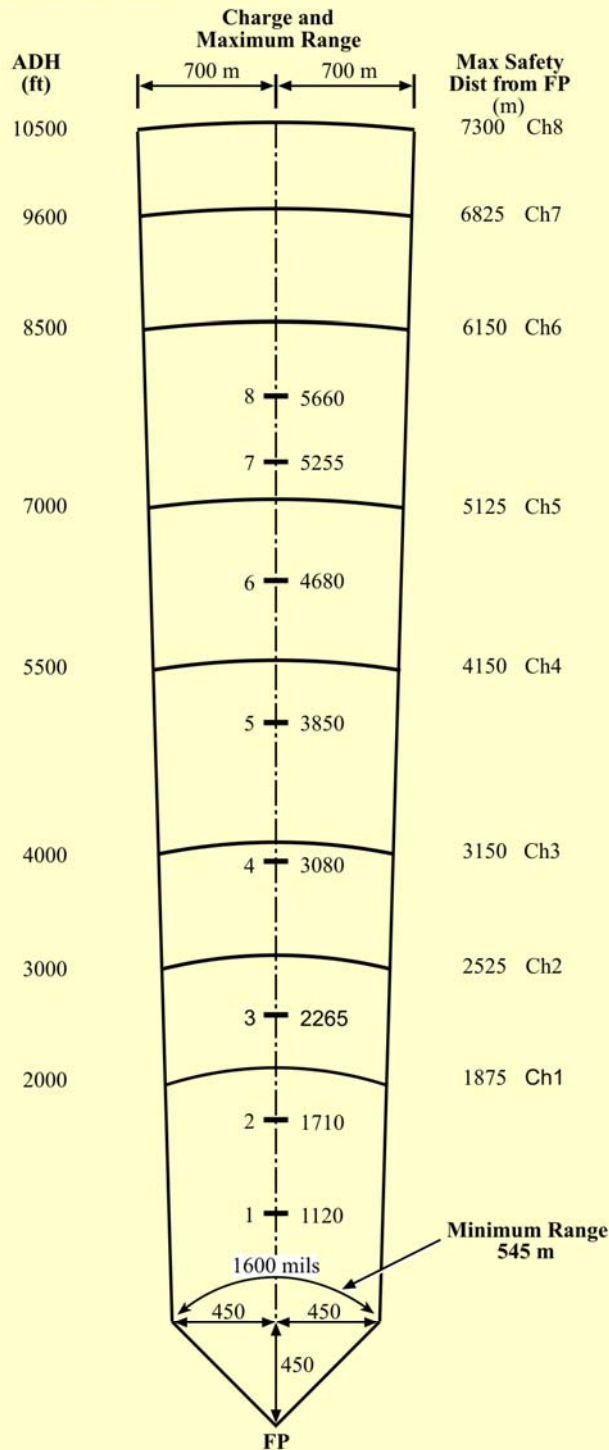

Notes:

1. Charge Primary only to be fired on operations.
2. For use with the service baseplate and the FV432

Figure 23-4. WDA Template, 81 mm Mortar L16, firing HE and WP - RBSD

**Not to Scale
Not to be Copied**

**Reference:
D/HQDT/11/18/43/14 dated 30 Jul 91
D/AG/TS/9/2/3/2 dated 9 Sep 97**

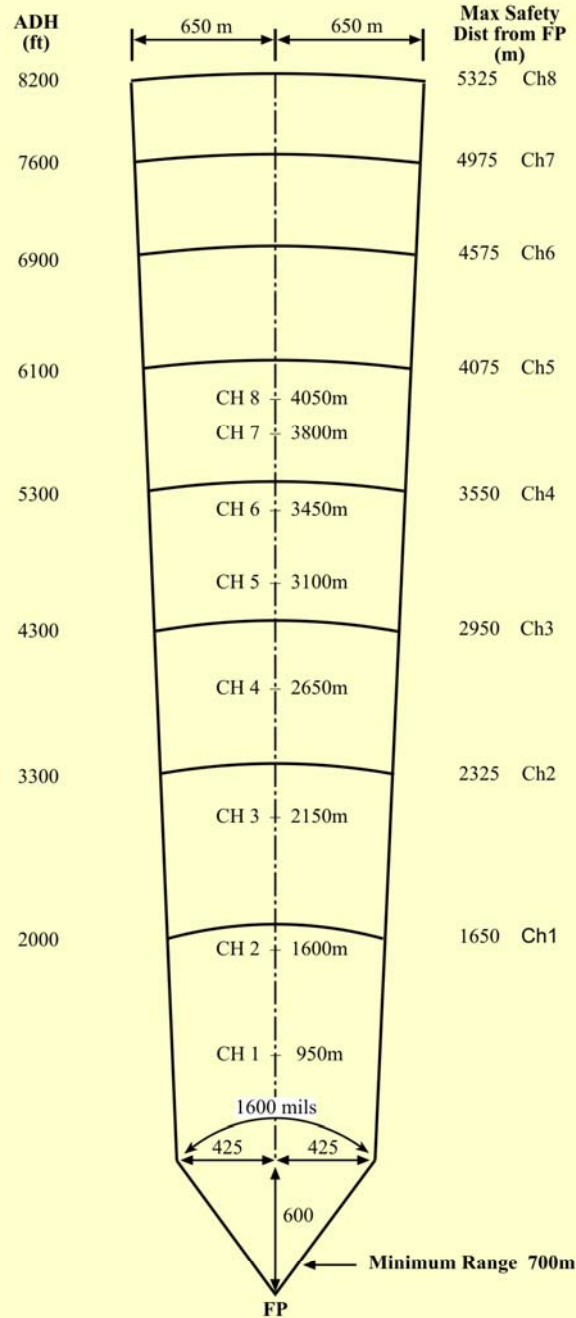

Notes:

- Charge Primary only to be fired on operations.**
- For a mean burst height greater than 800 ft add 0.6 x (mean burst height in feet - 800) metres to the width of the trace on either side.
- The template does not allow for the drift of the flare.

Figure 23-5. WDA Template, 81 mm Mortar L16, firing Para Illuminating

Reference:
D/OB/2201/2 dated 27 Jun 96
D/AG/TS/9/2/3/2 dated 9 Sep 97

Not to Scale
Not to be Copied

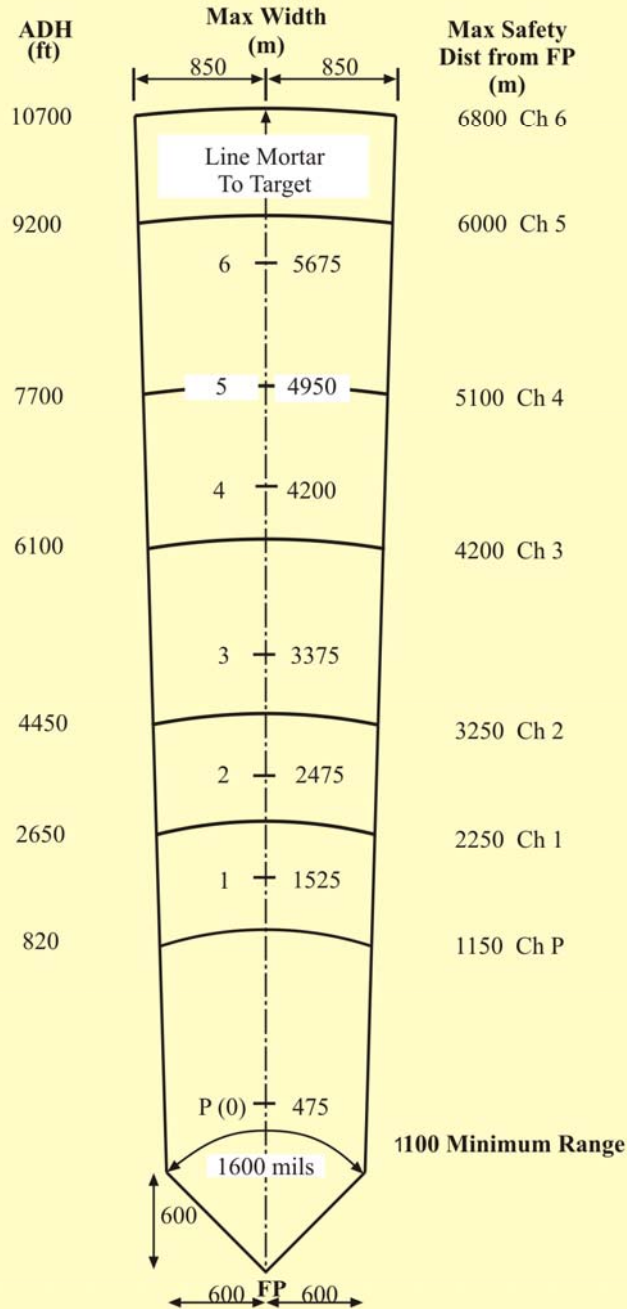

Notes:

1. Charge Primary only to be fired on operations.
2. For use with the service baseplate and the FV432

Figure 23-6. WDA Template, 81 mm Mortar L41 & L42, Mk4 Charge System - NBSD

**Not to Scale
Not to be Copied**

**Reference:
D/OB/2201/2 dated 27 Jun 96
D/AG/TS/9/2/3/2 dated 9 Sep 97**

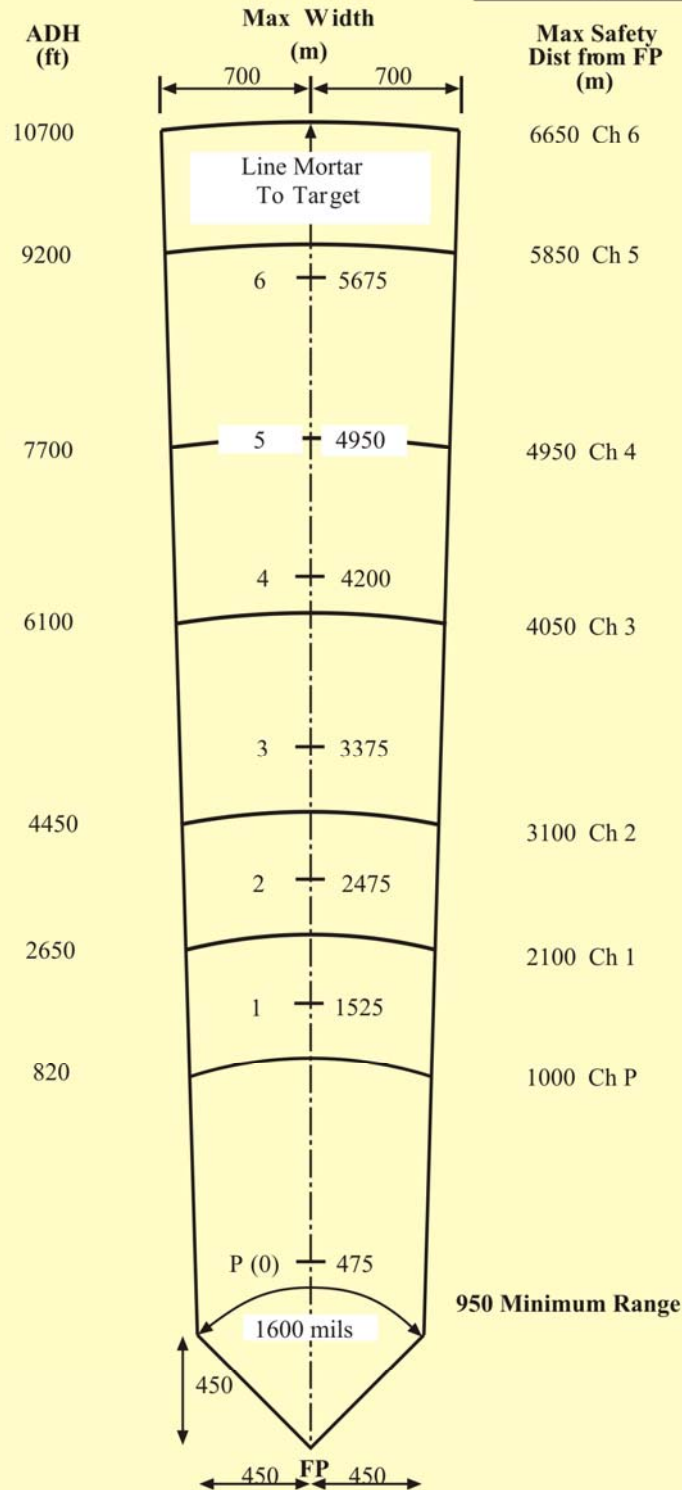

Notes:

1. Charge Primary only to be fired on operations.
2. For use with the service baseplate and the FV432

Figure 23-7. WDA Template, 81 mm Mortar L41 & L42, Mk4 Charge System - RBSD

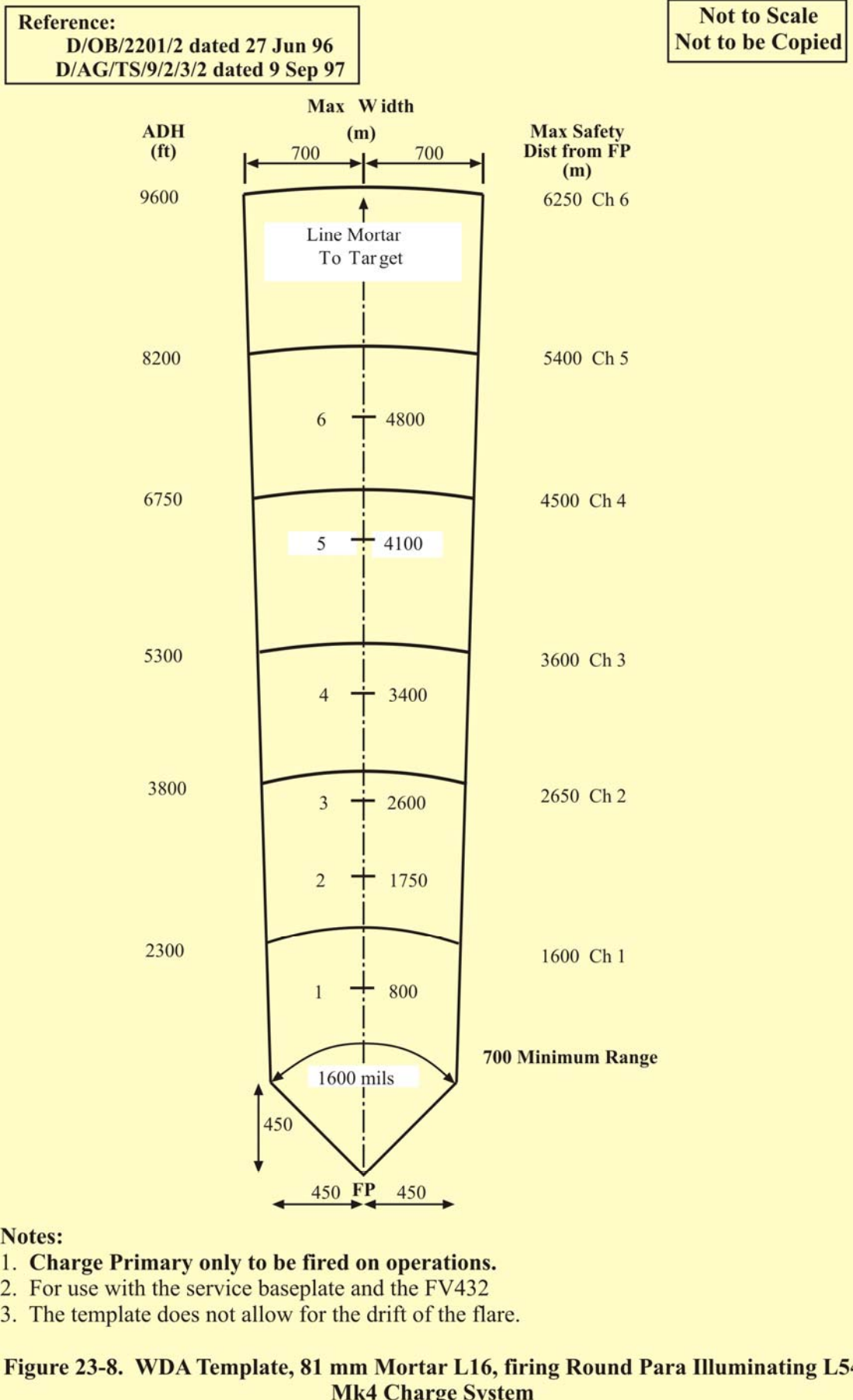

Not to scale Not to be copied

Reference: CSE/15/13/03b dated 12 Aug 04

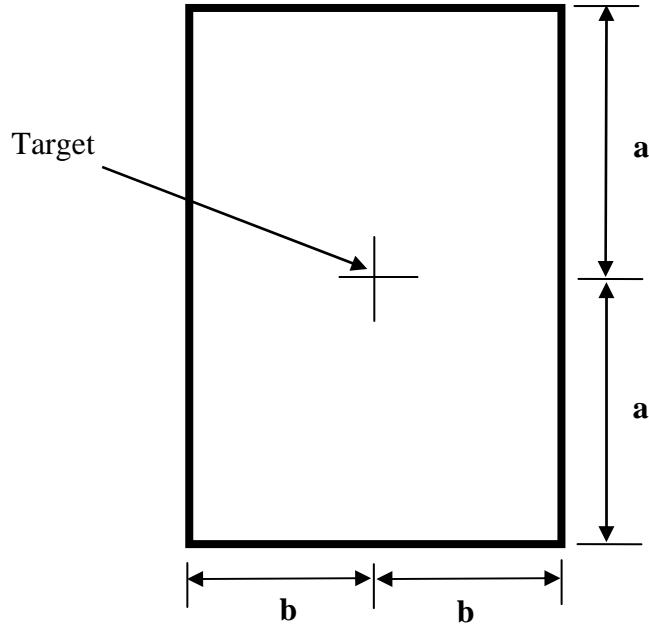

Charge	Normal (m)		Reduced (m)		Special (m)		Illum (m)	
	Length (a)	Width (b)	Length (a)	Width (b)	Length (a)	Width (b)	Length (a)	Width (b)
1	700	600	550	450	300	200	550	450
2	750	650	600	500	350	200	600	500
3	800	700	650	550	400	250	650	550
4	900	750	750	600	500	350	750	600
5	1000	800	850	650	600	350	850	650
6	1100	850	950	700	700	400	950	700

WDA

Notes;

1. The overall dimensions of the Overhead Fire WDA are measured from the centre cross to the outer edges of the box for each charge
2. For use in the Ground Role and with FV 432 and BV 206.

Figure 23-9. 81mm Mortar Mk.4 Charge System Overhead Fire Weapon Danger Area (WDA) Data.

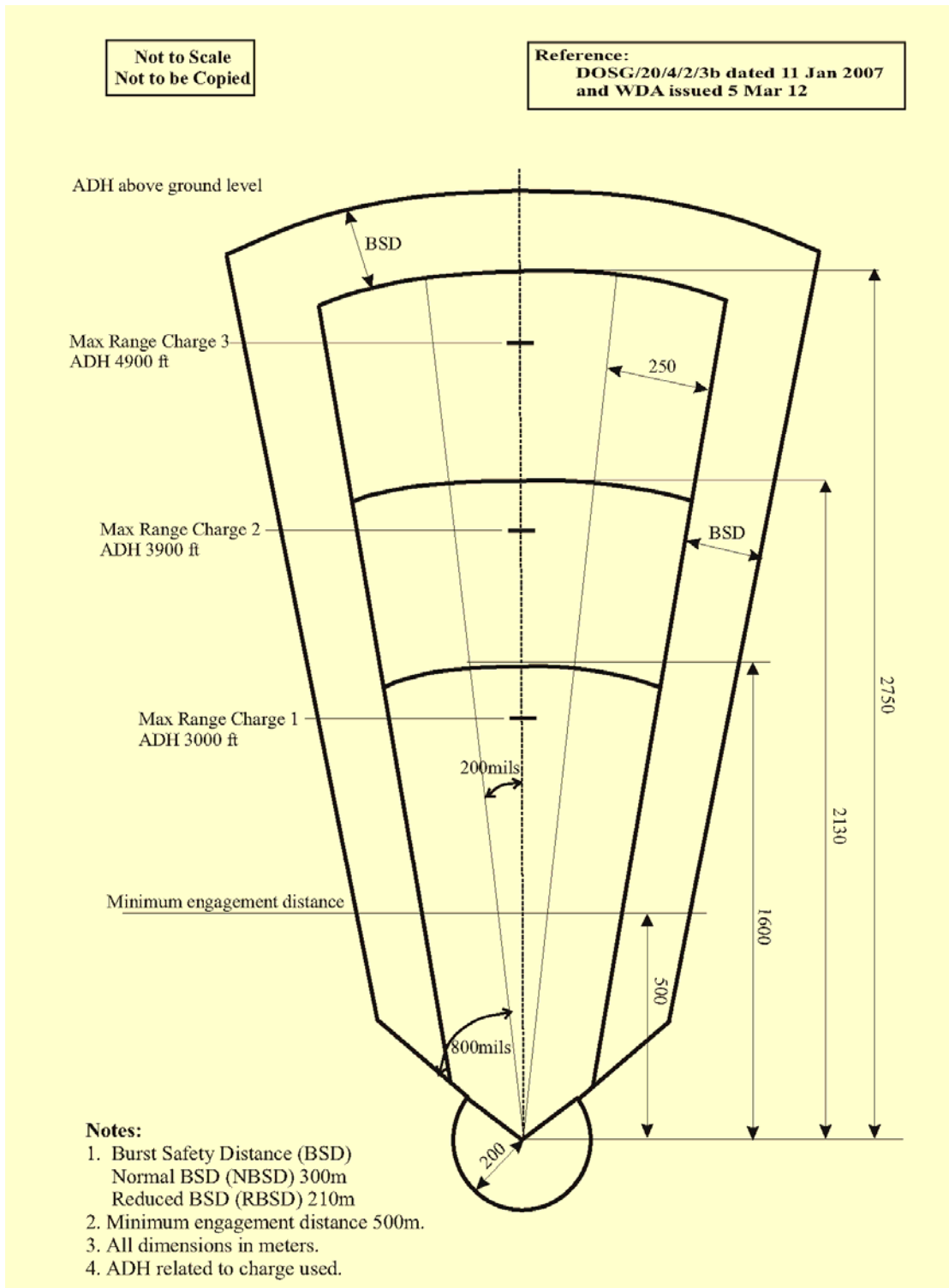

Figure 23-10. WDA Template , 60mm Motar M6-895 Light Role

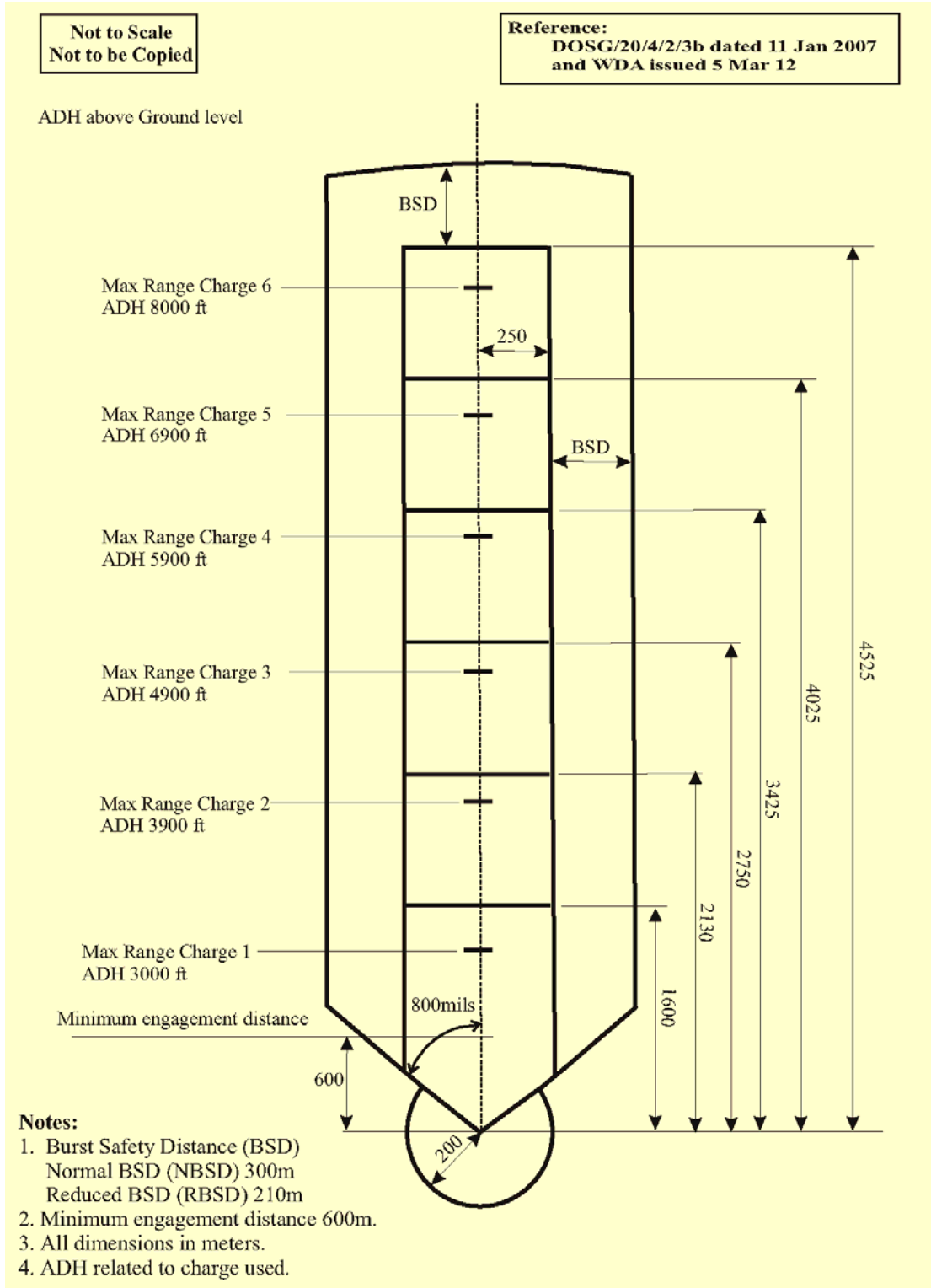

Figure 23-11. WDA Template , 60mm Motar M6-895 BipodRole

