

Track of G-BGHR Showing the Start of the Orbits  
 (Derived from ATC radar recording)

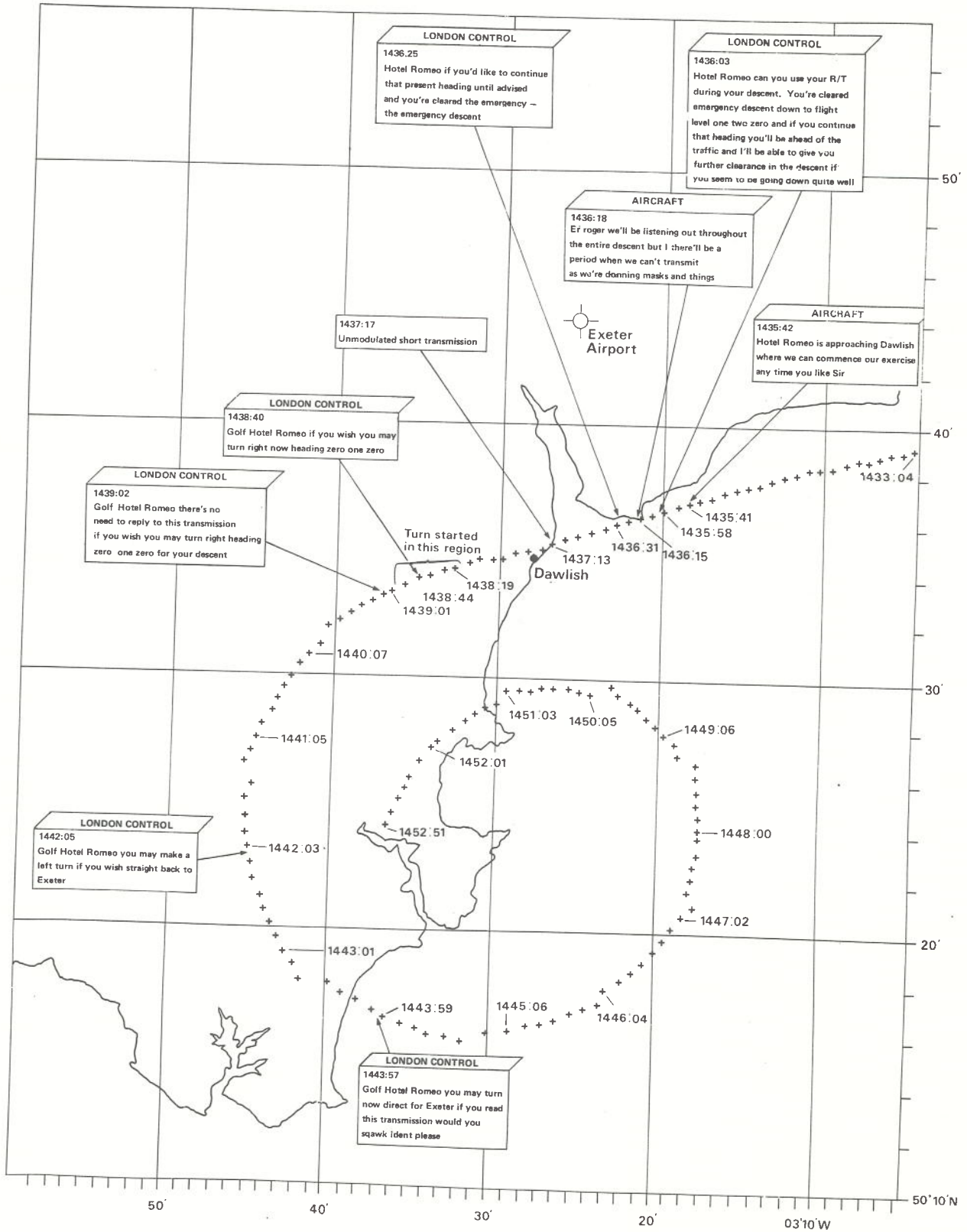

### Beechcraft Super King Air 200 Oxygen System

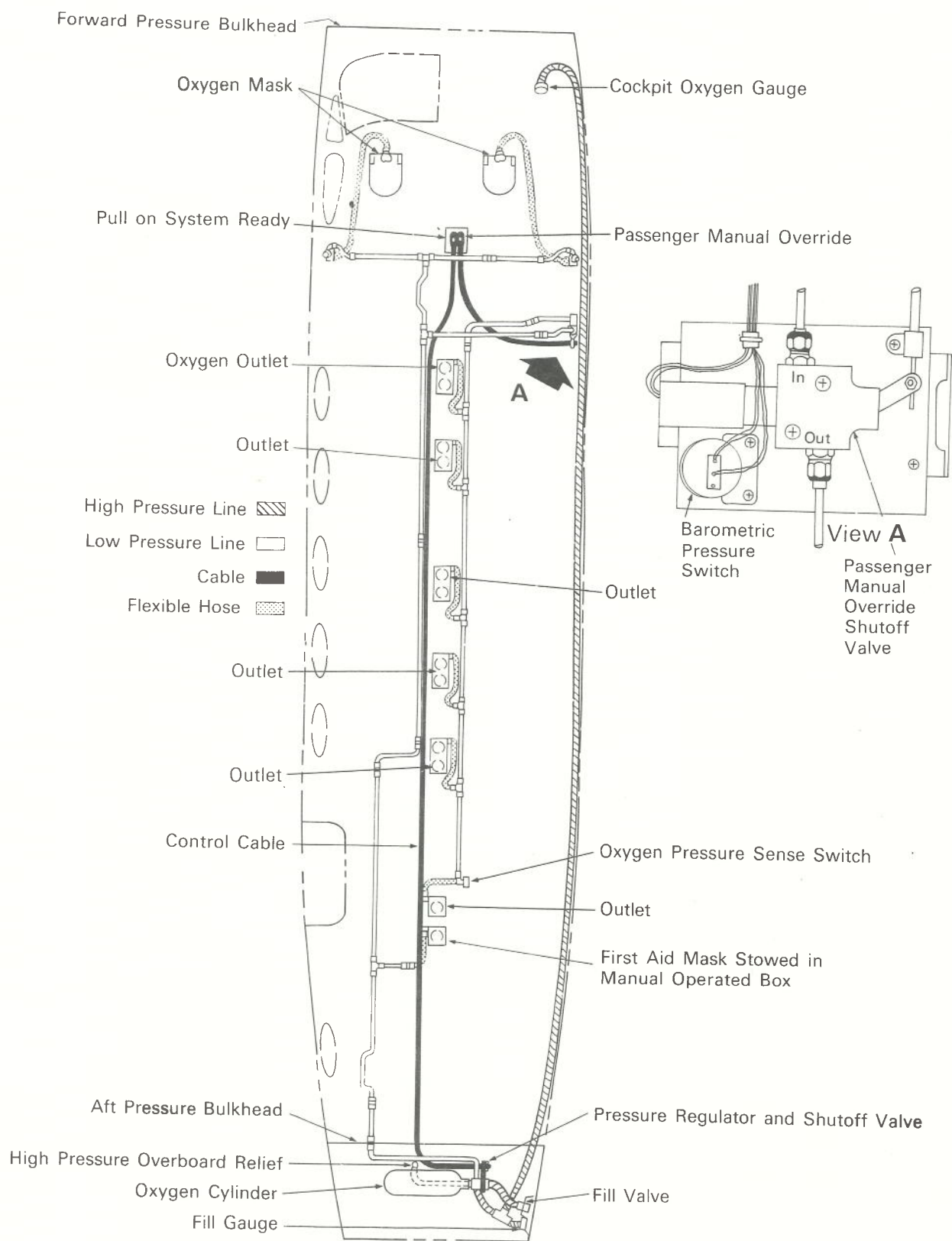

**Beechcraft Super King Air 200 Oxygen System  
Drop-Out Assembly Actuators**

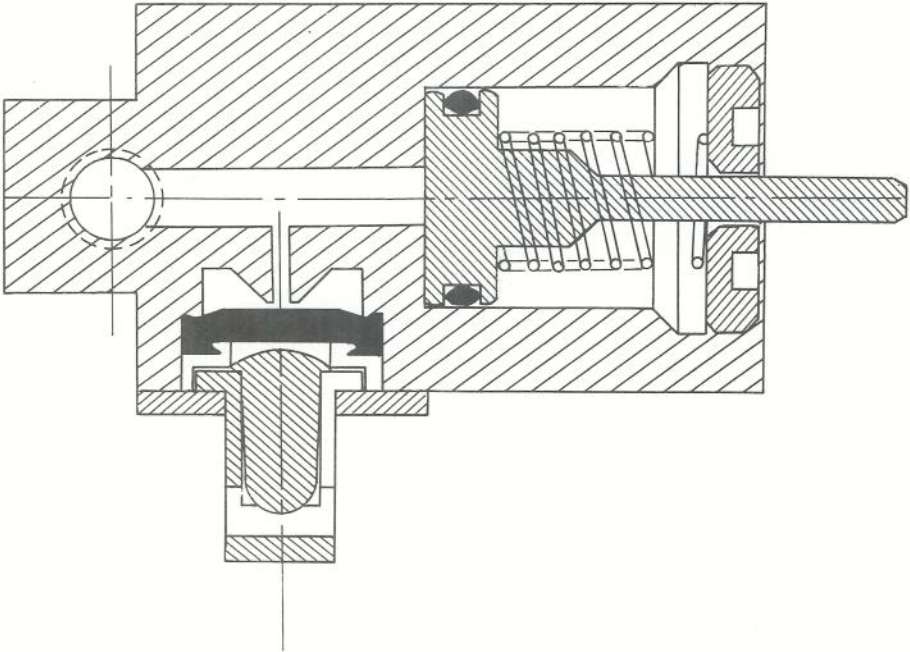
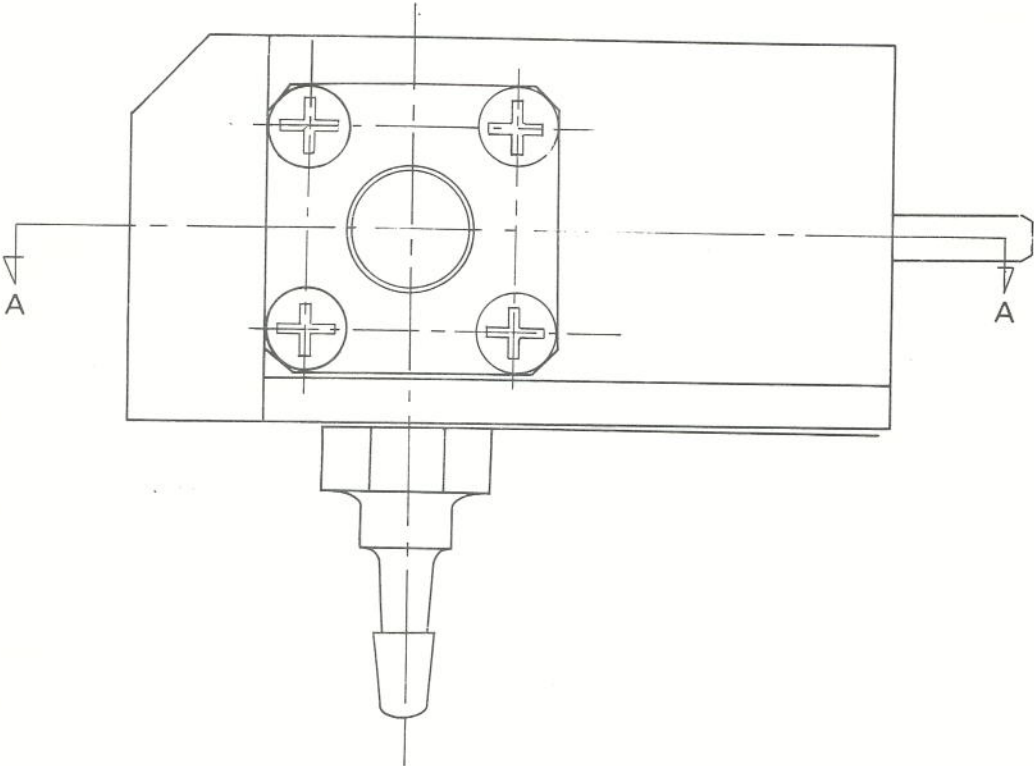

### Radiographic Examination of Oxygen System Drop-Out Assembly Actuators

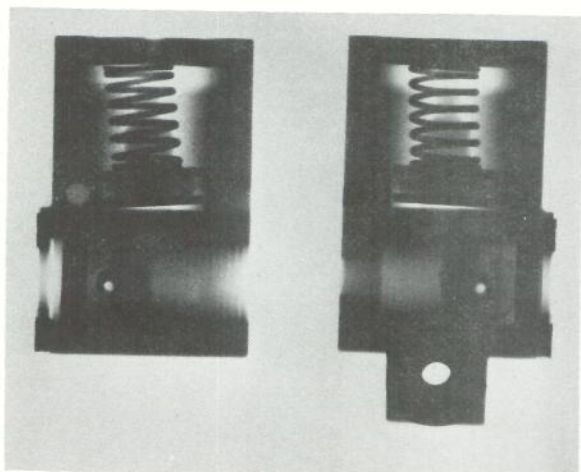

1B

1A

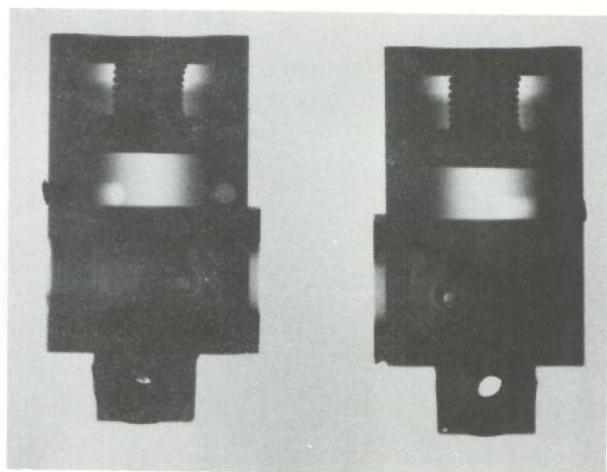

2A

2B

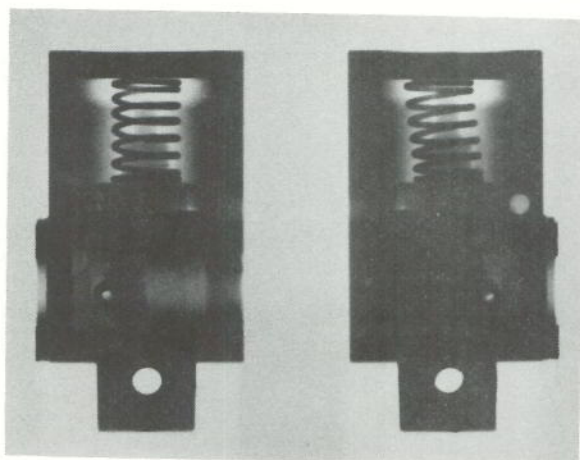

3B

3A

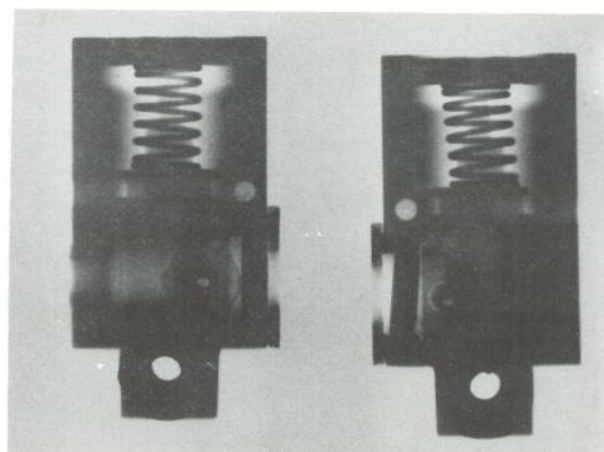

4A

4B

5B

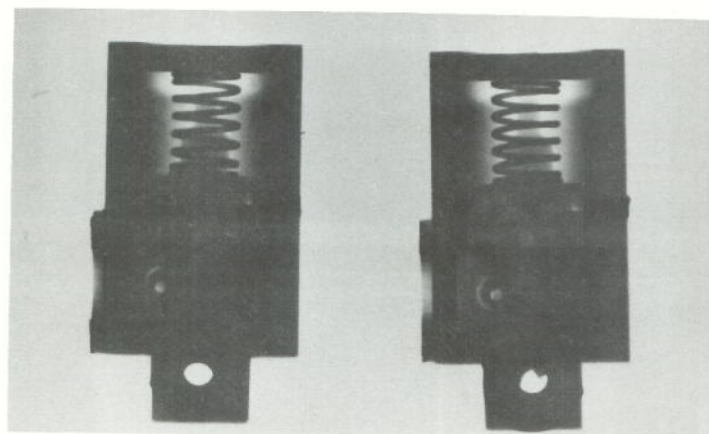

6B