

technopolis |group|

An evaluation of UKSA funding through the ARTES programme

Final Report

*Prepared for the UK Space Agency
June 2019*

An evaluation of UKSA funding through the ARTES programme

Final Report

technopolis _{|group|} June 2019

Neil Brown

Cristina Rosemberg

Aaron Vinnik

Marika De Scalzi

Acknowledgements

The authors would like to thank the large number of contractors and stakeholders who gave of their time generously to provide inputs to the evaluation. The information and evidence they provided was vital to the success of the study. Thanks are also due to staff at UKSA, for the information, guidance and support they provided during the study.

Executive Summary

The UK Space Agency (UKSA) commissioned Technopolis to evaluate the UK's participation in the European Space Agency's (ESA's) advanced research into telecommunications (ARTES) Programme. The study was commissioned to strengthen the body of evidence on the activities and outcomes of past UK investment in ARTES, to demonstrate benefits and value for money, and inform future decisions.

The study approach included desk-based research, a telephone-based survey of UK contractors (45 individuals from 40 organisations) and a series of 10 semi-structured interviews with representatives from ESA, UKSA, Innovate UK and industry. A further programme of 10 interviews supported the development of 7 case studies that looked in more depth at a selection of projects and contractors.

The ARTES Programme

Around 7% of ESA's budget (€389M) is allocated to telecommunications and integrated applications, within which ARTES is the main programme. It seeks to enable industry to explore innovative concepts and produce leading-edge satcom products and services, helping to secure the future of industry in the global market, while also developing solutions that meet the needs of institutions and society.

The programme funds a diverse set of activities, from market research to developing and demonstrating fully-functioning systems and novel technologies. Its sub-elements are grouped into three main areas:

- Core Competitiveness – a flexible framework for the support and development of new or next-generation satcom products and technologies up to their first flight opportunity
- Business Applications – to develop everyday applications and services that use satcoms technology to improve existing solutions or fill the gap left by terrestrial ones.
- Public-Private Partnerships – to leverage public and private investment and share risk with satellite operators and manufacturers to accelerate the introduction of new technologies into the market

In addition to funding, ARTES offers contractors access to technical advice and expertise, technical assets and communications and promotions support, for which Member States pay an overhead.

UK Investment in ARTES

UK space sector income grew to £14.8bn in 2016/17, up from £9.1bn in 2010/11. However, the UK has set an ambitious goal to capture 10% of the global market for space by 2030, which is to be achieved by further developing high-growth markets, pursuing exports and increasing investments through Europe.

The UKSA sits at the heart of UK efforts to benefit from space. The majority of its programme budget is invested through ESA programmes and it has contributed c. £765m to the ARTES programme since 2008. The UK has been at the forefront of shifting the focus of the ARTES programme over time towards commercially orientated activities. It has also invested heavily in the new IAP programme, which seeks to use space to enhance products or services and demonstrate their commercial potential in non-space sectors. The related establishment of ESA's newest facility (ECSAT), at Harwell in Oxfordshire, also seeks to stimulate market growth in the area related to new companies, products and services.

Programme Relevance

Stakeholders consulted for this study were clear that ARTES is a strategically important programme for the development and growth of the UK space sector (technology, capabilities, overall size and value). Satellite communications and their application are a key market segment for the UK and offer further significant potential for growth. Being a leader in this evolving market, and therefore being heavily involved in ARTES, is seen as crucial if the UK is to capture more of the global space market. Stakeholders also highlighted that ARTES operates as a bridge between the UK and Europe, and that this would likely become yet more valuable moving forward, as the UK leaves the EU.

Our survey of UK contractors found that additional funding was a main driver for programme involvement in nearly all cases, alongside a desire to increase the speed and scale of project activities that could be undertaken. Three-quarters of those consulted said that they would not have been able to go ahead with their project without the additional support investment provided by the programme. Some contractors were also attracted to ARTES because of the experience, knowledge and technical expertise offered by ESA. The reputational benefits of showing you could work to 'ESA standard' were also seen as important for raising the status of an organisation and opening up new opportunities.

Stakeholders were also clear that ARTES enables companies to expedite high-risk and innovative activities, which might otherwise take significantly longer to advance if funded solely through internal R&D budgets. Even for large UK firms that are part of multi-national companies, ARTES co-funding can help make the case for new developments (and internal investment) in the UK, not elsewhere.

Programme Benefits and Impacts

The study team assembled basic details of UK involvement in contracts funded through the main ARTES elements over the past decade (2009-18). We identified 375 projects with UK involvement, with 558 instances of UK participation in total (i.e. as primes and partners across these projects). Approximately 200 UK organisations have been involved, from across all parts of the UK, including 174 companies, 27 universities and colleges and 7 other public research bodies and institutions. The companies range from SMEs with turnover in the tens of thousands of pounds, to large multinationals with £100m+ revenues.

At the time that ARTES contractors were consulted for this study, most of their projects had concluded only within the past few years. As such, the results presented are preliminary and focused more on the immediate outputs and outcomes of participation; many of the benefits and impacts of the programme will only be realised and fully understood over the course of many more years. Nevertheless, contractors were also asked to provide informed opinions about the likely longer-term benefits and impacts of the programme on their organisation and in relation to the specific project idea or technology supported. In addition, there are also a number of examples of strong programme impacts that have already been identified at this stage, including within the selection of case study examples developed for the study.

Spin-in of organisations to the space sector – ARTES supports efforts to broaden and grow the UK space sector by encouraging new entities to ‘spin-in’ to space through the programme. Even amongst the sample of organisations consulted for this study we identified six firms (15% of those responding) that had not worked in the sector before. Several others were identified through our wider consultations. Stakeholders highlighted various sectors beyond space (insurance, transport, agritech, healthcare) that are increasing their interest in the value of utilising space applications and space-enabled technology. This has reportedly been helped by the ARTES ambassadors programme (and 5 regional ambassadors in the UK) that work with companies (and especially non-space firms) to develop their business ideas using space data and services, and to support their initial application to the ARTES programme.

More generally it is clear that ARTES has attracted a very wide range of organisations, spanning space manufacturing, applications, operations and ancillary services. There is also evidence that organisations already within the space sector are seeing an increased focus on space-related activities as a result of their participation, with most reporting improvements in awareness of their organisation as well as an expansion in their presence within upstream and downstream space markets.

New and strengthened partnerships - The ARTES programme seeks to forge partnerships within industry and three quarters of respondents to our survey said that their project involved collaboration with at least one other organisation. In a quarter of cases the respondent reported that at least one of their partners was *new* (i.e. they had never worked with them before the ARTES project) - with 10 new partnerships established in total across these projects. We estimate that over 73 such *new* collaborations between UK organisations will have taken place in total across the full portfolio of ARTES projects.

Nearly all of the organisations that had worked with a partner in their ARTES project reported that their relationship with these organisations had been strengthened during the project. Also, those that had worked with *new* partners were all found to have continued their relationships *beyond* the project.

New and improved knowledge, skills and capabilities - All contractors reported improvements to internal knowledge, skills and capabilities as a direct benefit of their participation in ARTES. Most also claimed to have used their new knowledge, skills and capabilities (e.g. relating to engineering, data analysis, project management and software) in other areas of their business.

Projects also engaged in activities to codify, disseminate and transfer knowledge. Based on responses provided, we estimate that every 100 ARTES projects with UK involvement might create around 90 refereed papers, ~25 other publications, ~40 dissemination activities and 5-10 patents.

Raising TRL levels – The study has found that most of the projects consulted that were at TRL 1-2 on application, had moved to TRL 3 or above by the end of their ARTES funding, while all (100%) of the projects starting at TRL 3-4 had progressed to TRL 5 or above. In fact, in most cases the projects reached TRL 7 or 8 (i.e. model or system demonstration for the intended environment).

Increased visibility and reputation of UK capabilities – Most participating organisations believe that ARTES has increased the visibility and reputation of their organisation and of their project idea or technology within the space sector. ARTES participation is also felt to have improved these organisations’ future-prospects in the space market (increased attractiveness to funders, increased likelihood of securing contracts and increased likelihood of expanded market presence).

Projects de-risked for further investment – Most contractors reported that their project had been de-risked through ARTES. In addition, two-thirds reported it had resulted in a reduction in the cost of their project idea, while three quarters claimed that it had reduced the time to market. Nearly two-thirds also claimed that their ARTES project had resulted in the demonstration of their technologies or concepts, while half reported new or improved technologies and products.

Generation of additional contracts and revenue – Despite most projects covered through our survey having only recently concluded, and the majority being in the lower TRLs at time of application, there are already many examples of projects generating additional revenue from their developments.

More than half reported having already generated new income, while another quarter are expecting this to be the case in the coming years. Only 6 (13%) reported that *no* new income was expected – either because the project had demonstrated a lack of feasibility, or because it was taken forward by another partner. This widespread generation of income is an impressive outcome for the programme, when one considers that a certain level of failure is expected when projects are exploring unproven technologies.

Not all contractors felt able to provide more details, but those that did reported ~£30M of new revenue and predicted £110-120M in the next 5 years. The case studies provide further examples.

Benefits to the wider UK economy and society – Three quarters of respondents reported that the products or systems developed through ARTES benefited end-users. These were spread across a range of sectors and offered various advantages over existing solutions (e.g. enhanced usability, more accurate information, new capabilities, reduced costs, and so on). A selection of the examples given include:

- Transport: Helping users find biking routes based on their ride preferences, drawing on open-access Earth imaging data coming from the Sentinel satellites
- Internet: Creating faster and more efficient media streaming services
- Disaster Relief: Developing back-up communication channels in the event of disasters
- Environmental monitoring: Monitoring live animal traps and sending notifications
- Agricultural: Farmers using an agronomic app to record the wheat growth stage
- Urban planning: Decreasing the risk of potential insurance premiums for construction
- Healthcare: Remote monitoring, fall prevention, wearable devices
- Safety: Technology to prevent and reduce the potential of bird strikes on civil aviation

Value for Money

The direct impact of the programme, based on the estimated value of **commercial and non-commercial contracts** emerging from ARTES projects, provides a very positive picture as to the value for money achieved from the UK's investment in the ARTES programme over the past decade.

- Surveyed contractors reported £156.1M in additional income (generated or expected, beyond the value of the contracts themselves) as a result of ARTES projects. Based on comparisons with contract values, we therefore estimate that each £1 of contracts leads to £14.4 in additional income.
- Based on this, the UK's investment through ARTES (c. £765M subscription since 2008) is likely to have led to £11bn in additional income (above and beyond the value of UK ARTES contracts).
- We also estimate each £1M in contracts leads to 15 additional jobs created or safeguarded

To assess value for money in terms of a **return on investment** (RoI), we follow the HM Treasury Green Book guidance (2018). This guidance is now more stringent. Previously, net additional income, as well as the knock-on effects on the economy (via multipliers), could be used as the basis for the value for money analysis. Under the current guidelines, however, only increases in the overall capacity of the economy –productivity gains or increases in labour supply - should be treated as net economic benefit.

- We estimate that the RoI from the UK participation is 7.5 based on *net* income. This means that each £1 invested by the UK (by UKSA and by UK contractors) leads to £7.50 in net benefit, in terms of additional net income (i.e. beyond the value of the contracts themselves).
- When one applies the more stringent rules of the new Green Book, we then find that each £1 invested by the UK leads to £0.9 in net benefit, in terms of additional profit.

These are conservative estimates, as they do not include the additional social benefits that may arise from, for instance, space-based applications being made available in a wide variety of industries, from agriculture to health, which have not been quantified in the context of this study.

The benefits of UK investment in ARTES

The Advanced Research in Telecommunications Systems (ARTES) programme has benefited **208 UK Organisations** across **375 projects** (2009-2018)

The ARTES Programme

Aims
 Developing new markets in advanced telecommunications
 Promoting industry to gain a significant foothold globally

A flexible framework of sub-programmes
 Funding activities from market research and feasibility studies, to demonstration and deployment

UK ARTES Contractors

174 Companies
 +
27 Universities
 +
7 PROs

Applications **58%**
 Manufacturing **24%**
 Operations **16%**
 Ancillary **13%**



Programme Benefits & Impacts

UK ARTES Contractors:

15% Were NEW "spin ins" to the space sector

24% Worked with NEW partners

82% Strengthened relationships through project

100% reported new & improved knowledge, skills & capabilities
 E.g. engineering, data analysis, project management, software tools

TRL 1-2 **82%** → TRL 3+

TRL 3-4 **100%** → TRL 5+
 5-6 → 7+

89% of projects increased TRL

Most reach TRL 7 / 8 (demonstration)

67% Projects de-risked for further investment

86% Reduced cost

78% Reduced time to market

Value for Money

Each **£1** of contracts
 ↓
£14.4 in additional income

80% of ARTES contractors believe the benefits outweigh costs

Wider Benefits for the UK

Advantages of ARTES-developed products / solutions:
 Reduce costs
 Greater reliability
 Reach new locations
 Enhance usability
 More accurate information
 New capabilities

Use Beyond the Space Sector:
 Safety
 Internet
 Transport
 Healthcare
 Agriculture
 Disaster Relief
 Urban Planning
 Environmental Monitoring



Increased Visibility & Reputation of UK Capabilities

ARTES involvement improves visibility and reputation

Contractors reporting increased:

- 91%** attractiveness as R&D partner
- 84%** visibility & awareness of their project / technology
- 89%** awareness & reputation of their organisation

ARTES involvement improves future prospects in the space market

Contractors reporting increased:

- 89%** attractiveness to funders
- 72%** chance of expanding presence in space markets
- 79%** chance of securing space contracts

Table of Contents

1	Introduction	1
2	The ARTES programme	2
2.1	Background and context to the ARTES programme	2
2.2	Programme aims and objectives	3
2.3	Programme structure / elements	3
2.4	Programme support	5
2.5	Programme Logic	5
3	UK involvement in the ARTES programme	7
3.1	UK projects, funding and participating organisations	7
3.1.1	Projects and elements	7
3.1.2	Organisations involved.....	8
3.2	Programme relevance.....	9
3.3	Motivations for involvement.....	10
4	Benefits and impact of involvement	12
4.1	Spin-ins to space	12
4.2	New and strengthened partnerships.....	13
4.3	New and improved knowledge, skills and capabilities	14
4.4	Codified knowledge and knowledge transfer.....	15
4.5	Raised TRL levels	15
4.6	Continuation of partnerships and collaborations (beyond the project)	17
4.7	Increased visibility and reputation of UK capabilities	18
4.8	Projects de-risked for further investment	19
4.9	Generation of additional contracts and revenue	20
4.10	Growth in the UK space sector.....	23
4.11	Benefits to the wider UK economy and society	25
4.12	Participant overall assessment.....	28
5	Value for money	29
5.1	Total commercial impact.....	29
5.1.1	Additional commercial and non-commercial contracts	29
5.1.2	Additional employment.....	30
5.2	Return on investment.....	31
Appendix A	Methodological annex	33
Appendix B	ARTES programme elements.....	41
Appendix C	Case studies	47

Tables

Table 1	Number of unique projects with UK involvement, per element	7
Table 2	Number of ‘participations’ and overall value to the UK, per element.....	8
Table 3	Outputs generated by survey beneficiaries.....	15
Table 4	Outputs generated by survey beneficiaries.....	20
Table 5	Income realised and expected by those already generating income	21
Table 6	Income expectations by those not yet generating income	22
Table 7	Specific examples of how the new technologies has been applied to different end users	26
Table 8	Additional income generated (based on survey responses).....	30
Table 9	Jobs created and safeguarded (based on survey responses).....	30
Table 10	Value for money assessment.....	32
Table 11	Indicators of programme inputs and activities	35
Table 12	Indicators of programme outputs.....	35
Table 13	Indicators of programme outcomes and impacts.....	36
Table 14	Overview of contact details available for the survey of UK contractors.....	38
Table 15	Overview of responses to the UK contractor survey, by programme element.....	39
Table 16	Overview of responses to the UK contractor survey, by organisation type	39
Table 17	Programme management / stakeholder interviewees.....	40
Table 18	Programme management / stakeholder interviewees.....	40
Table 19	Key features of ARTES elements	45

Figures

Figure 1	Overview of ARTES elements	3
Figure 2	Logic model for (UK investment in) the ARTES programme	6
Figure 3	Main factors motivating the organisation’s involvement in the ARTES programme	10
Figure 4	Technology Readiness Levels (TRL).....	16
Figure 5	Progression of TRL levels amongst respondents.....	16
Figure 6	Improvements to reputation, visibility and awareness through ARTES projects	18
Figure 7	Impact of ARTES involvement on future prospects in the space market	19
Figure 8	Likelihood that developments supported through ARTES will lead to new income (n=45).....	21
Figure 9	Longer term impacts of ARTES projects on participating UK organisations	24
Figure 10	Products or systems developed through the project benefit end-users in ... (n=45).....	25
Figure 11	Advantages offered by the Satcom technology (n=37).....	26
Figure 12	Assessment of costs vs benefits.....	28
Figure 13	Overview of ARTES elements	41

1 Introduction

The Evaluation

The UK Space Agency (UKSA) commissioned Technopolis to evaluate the UK's participation in the European Space Agency's (ESA's) advanced research into telecommunications (ARTES) Programme.

The programme aims to capitalise on R&D activities and transform them into operational satcom products and services. By offering varying degrees of support, it seeks to transform this investment into commercial success, helping to secure the future of member state industry in the global satcom market. The UK is a leader in satellite telecommunications and has been a key investor in the ARTES programme for many years, contributing around a quarter of all member state subscriptions.

The study has been commissioned to strengthen the body of evidence on the activities and outcomes of past UK investment in ARTES, both to demonstrate the benefits and value for money, as well as inform future decisions (e.g. the UK will decide on its future ESA investments at the Ministerial Council in 2019). The evaluation was asked to assess the extent of (positive) difference that UK ARTES funding has made within the UK, and the extent to which these benefits justify the costs and effort involved.

The approach

A mixed-method approach was employed, organised around three main packages of work. A short inception period was used to review available programme documentation and data, develop the programme logic model and evaluation framework, and finalise the evaluation approach. A main phase of evidence gathering then consisted of telephone surveys of beneficiaries, a small programme of stakeholder interviews and the development of a series of illustrative case studies focused on particular ARTES projects and contractors. A final phase of the study drew together and analysed the various information and evidence gathered in order to address the key requirements and questions of the study.

Only a limited amount of programme documentation and data were available to the study team, and so the approach relied heavily on a series of primary data collection activities. This included:

- A telephone-based survey of project leads (45 individuals from 40 organisations)
- Semi-structured interviews with 10 representatives from ESA, UKSA, Innovate UK and industry
- Interviews with 10 individuals in UK organisations to develop 7 in-depth case studies.

Further details of the study requirements, approach and methods are set out in Appendix A.

This report

Following this brief introduction, the remainder of this report is structured as follows:

- Section 3 – provides an overview of the ARTES programme, its aims and structure. Further details of individual programme elements are also provided in Appendix B.
- Section 4 – presents a summary of UK involvement in the programme (number and value of projects, number and type of organisation involved), before presenting feedback from contractors and stakeholders on the relevance of the programme and the main motivations behind UK participation.
- Section 5 – presents the results of the impact evaluation, which are organised according to the main areas of intended outputs, outcomes, benefits and impacts to the UK of involvement. This draws mainly on evidence collected through our survey of contractors, but is also enhanced with views and quotes taken from discussions with public and private sector representatives and stakeholders.

Examples are also provided, summarising elements of the seven in-depth case studies of ARTES projects and contractors. These cases are presented in full in Appendix C.

- Section 6 – provides an overall assessment of the programme's value for money, based on the estimated value of contracts resulting from ARTES projects and the effects of these on the economy

2 The ARTES programme

2.1 Background and context to the ARTES programme

More than fifty years ago, Britain became the third nation to launch a satellite, Ariel 1. It has since participated in numerous science missions and R&D programmes, while its space industry has grown rapidly. Space technology has also become critical for providing UK citizens and businesses with the infrastructure to underpin societal and economic wellbeing, from communications and navigation, to weather forecasting, environmental monitoring, and support for defence.

The UK has published several **space strategies** in the past decade. The Space Innovation and Growth Strategy (SIGS, 2010) set out a partnership between industry, government and academia to develop new space related opportunities. This led to the creation of the UK Space Agency, Leadership Council, Satellite Applications Catapult and the Space Gateway at Harwell. The SIGS was followed with an Action Plan (AP) in 2014, and update in 2015. In 2012, UKSA published a Civil Space Strategy, along with sector-specific strategies, and in 2015 the government published its first National Space Policy, which includes the aspiration to establish a spaceport. More recently, the Space Industry Bill (2018) seeks to streamline regulation and provide a framework for future activities, including the first space launches. The recent 'Prosperity from Space' strategy (2018) also sets out ambitions for enhanced growth of the UK space sector over the next decade, recommending a focus on four priorities: earth information services; connectivity services; in-space robotics; and low-cost access to space.

The **UK Space Agency (UKSA)** sits at the heart of UK efforts to explore and benefit from space and works to both showcase UK investment and ensure that this brings about real economic, societal and scientific benefits. In 2017/18, its programme budget was £380m, with nearly 80% allocated to the European Space Agency (ESA), and the remainder financed a range of smaller programmes, including the International Partnerships in Space Programme and the National Space Technology Programme (NSTP). Compared to other major countries in Europe, the UK's domestic space programme is relatively small. As a result, the UK space sector is very commercially-focused, generating just 14% of its income from the public sector (3.1% from space agencies), compared to a global average of 24%.

The **UK space sector** is growing, with income increasing from £9.1bn in 2010/11 to £14.8bn in 2016/17¹. It is also a recognised leader in the development of satellites, especially small satellites, drawing on its strong space research base. However, the SIGS AP sets out an ambitious goal for the UK to capture 10% of the global market for space by 2030, implying a UK sector worth £40 billion. This is to be achieved by: developing new high-growth markets; improving regulation; pursuing exports (by launching a national space growth programme, supporting international collaboration, running R&D calls aligned with technology roadmaps and implementing an export promotion plan); and increasing investment through – and returns from – Europe.

The **UK's involvement with ESA** has increased over recent years. Responding to the SIGS call to reach average investment (~£400m) by 2020, the Government raised its contributions from £220m (2010) to £300m (2015) and then in 2016 announced an allocation of €1.4 billion over 5 years (including an expanded €670.5M investment in satellite technologies and services). The UK is now the fourth biggest contributor to ESA (8.8% of Member State funding in 2019) and this visible commitment is thought to have improved the UK's credibility and given it a stronger voice within ESA.

ESA's annual budget (€5.7bn, 2019) includes €4.2bn from members, plus €1.5bn from the EU, Eumetsat and other sources. About 85% is spent on **industry contracts**. The value of membership is greater than fair return; with investments in programmes estimated to return £10 for every £1 invested².

Around 7% (€389M in 2019) of ESA's budget is allocated to the telecommunications and integrated applications domain, within which **Advanced Research in Telecommunications Systems (ARTES)** is the main programme. Telecommunications is by far the most mature of space applications, and ARTES seeks to enable industry to explore - through R&D activities – innovative concepts to produce leading-edge satcom products and services. By offering varying degrees of support, the programme aims to transform this investment into successful commercial products and services, helping to secure the future of member state industry in the worldwide satcom market.

¹ London Economics (2019) Size & Health of the UK Space Industry 2018

² London Economics (2015) Return from Public Space Investments

2.2 Programme aims and objectives

ESA support for telecommunications began in 1968 with funding for the Orbital Test Satellite that launched a decade later. Momentum picked up in the 1980s as industry grew and more targeted programmes began developing advanced systems for air/maritime communications. The 1992 ESA ministerial endorsed the combination of the Advanced Systems and Technology Programme with the Payload and Spacecraft Development and Experimentation programme, to create ARTES. As such, the ARTES programme was initially designed with a twofold mandate to: (i) develop new markets in advanced telecommunications; and (ii) to promote industry to gain a significant foothold globally. Twelve ARTES elements (sub-programmes) were initially approved in the 1990's.

ARTES is now ESA's main telecommunications initiative, funding a diverse set of activities from market research to developing fully-functioning systems and novel technologies. Its two core objectives are to maintain / improve the capability and competitiveness of participating countries in the global satcom market; and to develop satellite-based solutions that meet the needs of institutions and society³.

2.3 Programme structure / elements

Given its broad objectives, ARTES has evolved over time to meet changing needs. The various sub-elements of the programme are now grouped into **three main areas**, or 'branches' of activity:

- Support for the **Core Competitiveness** of European space industry – providing a single, streamlined, yet flexible framework that allows industry to start with an idea and develop it through to the introduction of new products and services to the market. There are two main components to this area of the programme: Advanced Technology; and Competitiveness and Growth.
- **Business Applications** – a relatively new approach in which commercial applications using any space assets are addressed, mainly through the Integrated Applications Promotion (IAP) programme. This branch of ARTES develops everyday applications and services that use satcoms technology to improve existing solutions or fill the gap left by terrestrial ones. A new class of activities called Kick-start has also recently been introduced to the business applications area to attract new players.
- **Public-Private Partnerships** - a mechanism to leverage public funding with private investment, ensuring that risk in new ventures is allocated to those best able to handle it⁴ and helping accelerate the introduction of new technologies into the market. ESA has developed a portfolio of ~15 ARTES PPPs, which between them involve all European satellite operators and primes. Some PPPs are ESA-initiated, while others are initiated by industry (through the ARTES Partner programme).

In addition to which are the **Future Preparations** (scoping studies) and **ScyLight** (development, demonstration and utilisation of innovative optical technologies) elements.

The **current ARTES elements** (see Figure 1) form a flexible framework across the full value chain, funding activities from market research and feasibility studies, to demonstration and deployment.

Figure 1 Overview of ARTES elements

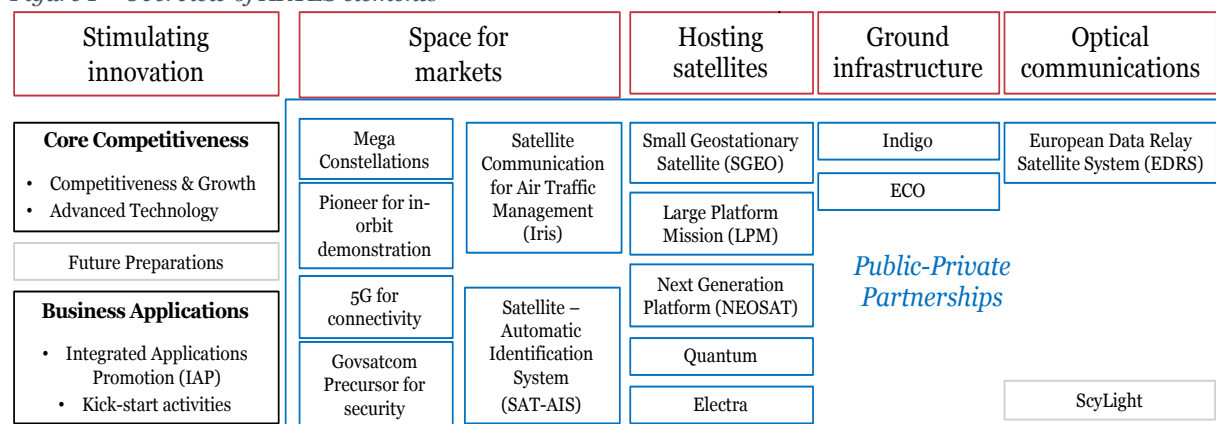

³ ELIA, C. 2011. *Overview of the ARTES Programmes: Building a winning proposal for the ESA-ARTES Programme*. ESA

⁴ With the programme absorbing more risks associated with technology development while a lead partner manages market risks related to operation, service provision and construction with other industry partners

UK effort and funding has focused particularly on certain elements of the programme. For example, the three areas introduced in boxes below collectively account for nearly two-thirds of the UK's c. £765M contributions to ARTES in the past decade. Additional information on all programme elements (including on those not mentioned below) is provided in Appendix B.

Core Competitiveness: a merger of the Competitiveness & Growth and Advanced Technology elements to improve the flexibility of funding and support to contractors. It supports developers of satcom products, services and partnerships, at any point in the development cycle, combining the benefits of former programme elements, as detailed below. UK subscription: c. £294M 2008-18.

Competitiveness & Growth: The development, qualification and demonstration of “products” (a piece of platform, payload or satellite equipment, a user terminal or full telecommunication system) and telecommunication applications, with the aim of facilitating competitiveness in the satcom industry. The C&G element targets four development phases to support nascent technologies as well as newcomer SMEs to reach maturity, providing varying levels of funding adjusted to the risk level of innovation. The four phases are:

- Definition (max 50% funding) – support for initial design concepts
- Technology (max 75% funding) – mitigation of technical risks during prototyping and testing
- Product (max 50% funding) – preparation for commercialisation
- Demonstration (max 50% funding) – support for market entry and piloting/validation.⁵

Advanced Technology: research and development activities for long-term satcom industry requirements, focusing on satellite technologies, ground and user equipment. The element's R&D foci are based on the Annual Workplan produced by the Future Preparations element which combines ESA and industry concerns for emerging telecommunications sector challenges and opportunities. Activities of contractors accepted to this element are 100% funded by the ESA

Integrated Applications Promotion (IAP) (UK subscription: c. £116M since 2008)

Supporting the development, implementation and pilot operations, through funding feasibility studies and demonstration projects that utilise data from space assets in combination with terrestrial services for new commercial and public functions. UK companies have used IAP to develop telemedicine services, advise farmers on fertilization, and target waste collection. Importantly, applications are developed in response to end-user requirements, rather than driven by a specific technology.

Next Generation Platform (NEOSAT) (UK subscription: c. £67M since 2008)

Specifically aimed at developing and demonstrating in-orbit, two new satellite platform product lines, Eurostar Neo and Spacebus Neo, to grow European capability in 3-6 tonne geostationary satellites. The core aim of NEOSAT is to reduce the cost of in-orbit data capacity, by electrifying craft propulsion, increasing payload, and reducing manufacturing costs through modular design and supply chain integration. Neosat is jointly managed by ESA and CNES, in partnership with industry.

⁵ <https://artes.esa.int/news/evolution-artes-3-4-and-5>

2.4 Programme support

ESA provides **varying levels of funding** to contractors through ARTES, ranging from 100% for early stage development of high commercial and/or technical risk technologies, 75% for projects with a clear market potential, and 50% for projects based on existing technologies with established market opportunities.⁶⁷ ARTES also awards SMEs with up to 75% (max €250,000) of R&D costs through its Competitiveness and Growth programme, to encourage more companies into the sector.

Contractors can apply for funding by responding to competitive ITTs, submitting unsolicited proposals to Open Calls for Proposals, as well as responding to the Call for Ideas for ARTES' Annual Workplan - an horizon scanning exercise, from which strategic Advanced Technology contracts are awarded.

In addition to funding, ARTES offers contractors access to other **programme support**, for which UKSA pays an overhead of around 15% (the actual amount varies by funding line). The support includes:

- **ESA technical advice and expertise:** Contractors participating in ARTES gain access to the programme's network of research, industry, administrative and regulatory expertise, which includes: system engineering; regulatory guidance; demonstration and promotion guidance; in-orbit Validation guidance; and partnership frameworks and brokerage.
- **ESA technical assets:** Contractors are also offered access to ESA equipment for use either on ESA premises or through loan agreements for use off site.⁸ This equipment includes satellite capacity, satellite systems emulators and simulators, and various radio frequency and testing resources.
- **Communications and promotions:** Besides the telecommunication pages of the main ESA portal, the ARTES programme reaches out to industry and user communities through dedicated websites for mainstream telecommunications (artes.esa.int) and applications (artes-apps.esa.int).

2.5 Programme Logic

Based on the information set out above, the study has developed a **theory of change** (see Appendix A.2) that draws connections between the investments by the UK government and UK-based industrial partners (inputs), the activities and support unlocked thanks to those investments and the immediate outputs that they generate. It also describes how those outputs could then materialise into short- and long-term outcomes (among UK contractors) and then further impact on UK industry and the economy.

The projects in scope are from different elements of the programme, which have different objectives and support different TRLs. However, the study needed to arrive to a final aggregated view of programme results overall. As such, we developed a programme-level **logic model** from the ToC that incorporates the rationale for UK investment and that identifies outputs and outcomes that are reasonable to expect from the different elements and from a technology programme of this nature, and where the potential outcomes of each project could be classified within the broader 'outcome/ impact' categories set at the programme level. That is not to say that all individual projects are expected to realise *all* of the benefits presented in the model, but – wherever they sit within the programme – their individual 'logic' should fit within this overarching framework. The logic model is presented in Figure 2.

⁶ <https://artes.esa.int/business-artes>

⁷ <https://artes.esa.int/news/evolution-artes-3-4-and-5>

⁸ <https://artes.esa.int/esa-technical-assets>

Figure 2 Logic model for (UK investment in) the ARTES programme

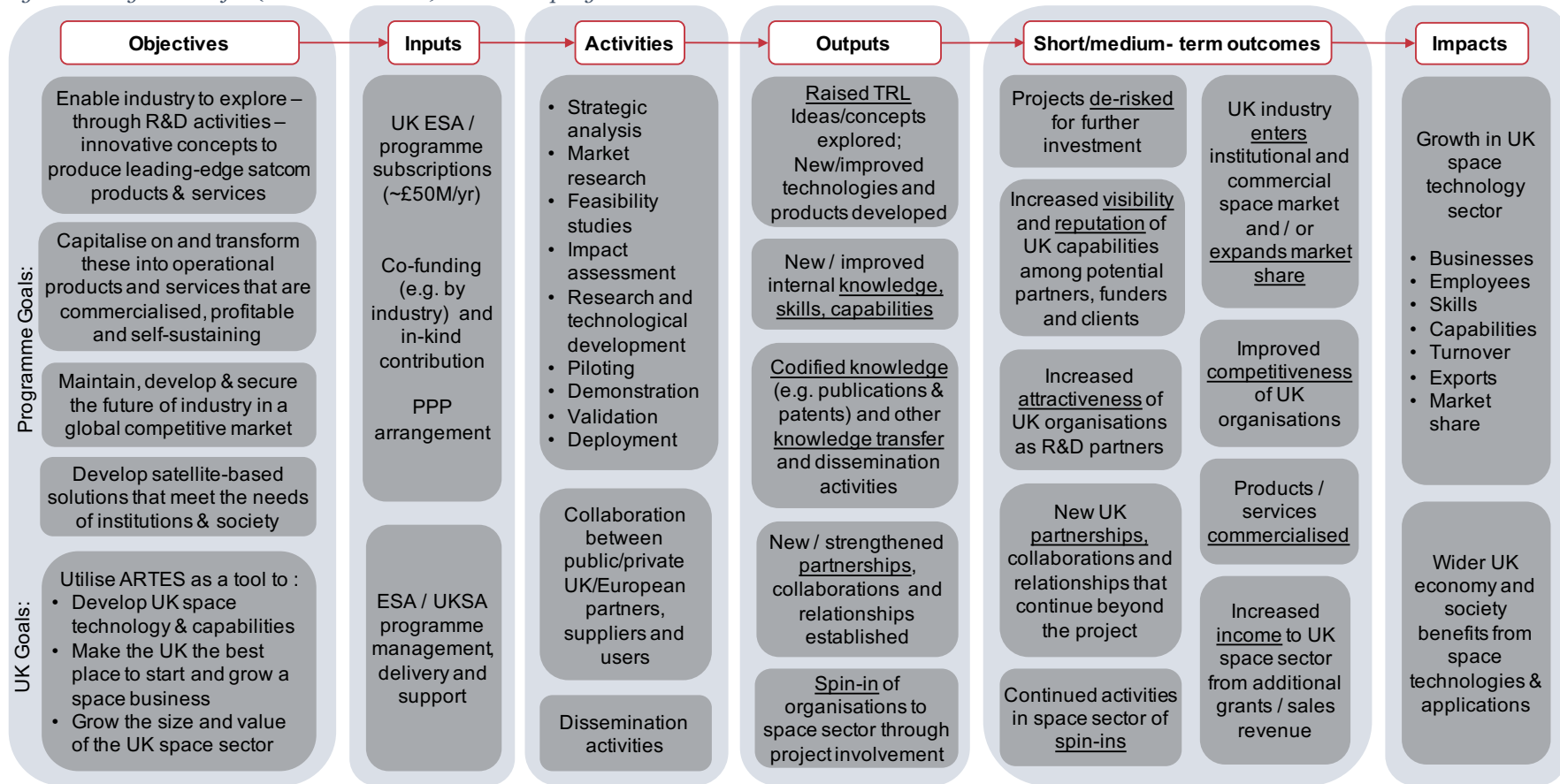

3 UK involvement in the ARTES programme

The UK is a global leader in satellite telecommunications and invests heavily in the ARTES programme (around a quarter of all member state subscriptions). Between 2000 and 2010, its annual investment ranged from €12M to €31M per year⁹, while more recently this investment has further increased.

At the most recent ESA Ministerial Council (2016), the UK announced a further €319 million investment in telecoms projects through ARTES over the following 5 years¹⁰. This included: €60 million to develop commercial use of space data via the IAP programme; €31 million for the IRIS programme (satellite communications to improve air traffic control and reduce CO2 emissions and costs); €38.5 million to the Inmarsat Communications Evolution (ICE) project (supply chain for next-generation satellite services, including IoT); and €30 million for a new navigation technology programme.

In total, the UK has made contributions of approximately £765M to the ARTES programme since 2008.

3.1 UK projects, funding and participating organisations

UKSA provided the study team with **details of UK involvement in contracts** funded through the Core Competitiveness programme (including Competitiveness and Growth, as well as Advanced Technology elements) and through the Integrated Applications Promotion (IAP) programme, for the period 2009 to August 2018. This included details of the contracts (title and value) and the organisations involved. The study team also extracted similar information (though not contract values) from the online ARTES projects database¹¹, covering the Future Preparations element, as well as selected PPPs (IRIS, LPM and SAT-AIS). Similar information for the other ARTES elements was not available.

Below we provide an overview of UK involvement across these main elements of ARTES, summarising the UK project portfolio and organisations involved, based on the information available.

3.1.1 Projects and elements

Across these elements of the programme, there are 375 projects with UK involvement. This includes 134 projects funded through IAP, 133 through C&G, 65 through Future Preparations and 26 through Advanced Technology elements. Around two-thirds of the projects were marked as completed (n=227), while the remainder were ongoing (133) or planned (15) – although this information may be out of date.

Table 1 Number of unique projects with UK involvement, per element

ARTES Element	Projects involving UK	Completed	Running	Planned
Future Preparations programme	65	59	6	-
Competitiveness and Growth programme	133	91	39	3
- Definition	9	8	1	0
- Technology	39	24	14	1
- Product	76	54	20	2
- Demonstration	9	5	4	0
Advanced Technology	26	9	17	0
Integrated Applications Promotion (IAP)	134	56	66	12
Satellite Communication for Air Traffic Management (IRIS)	10	7	3	-
Large Platform Mission (LPM)	5	3	2	-
Satellite – Automatic Identification System (SAT-AIS)	2	2	0	-
Total	375	227	133	15

⁹ <https://publications.parliament.uk/pa/cm200607/cmsselect/cmsstech/66/66o8.htm>

¹⁰ <https://www.gov.uk/government/news/uk-commits-to-european-collaboration-on-science-and-exploration-satellite-technology-and-services>

¹¹ <https://artes.esa.int/projects>

Because some contracts involve more than one UK organisation, there are a **larger number of (n=558) UK ‘participations’** in total across these 375 projects. This includes 298 instances of a UK organisation acting as prime and 260 instances where a UK organisation is a partner (sub-contractor) in the project. The table below shows the distribution of these across different elements, as well as overall **funding** to the UK where available (for the C&G, AT and IAP elements). As can be seen, the IAP projects tend to be smaller in size than those funded through the competitiveness and growth element.

Table 2 Number of ‘participations’ and overall value to the UK, per element

ARTES Element	UK org. as prime	UK org. as partner	UK participations total	Value to UK (millions)
Future Preparations programme	35	60	95	-
Competitiveness & Growth	119	39	158	142.3
- <i>Definition</i>	9	1	10	1.7
- <i>Technology</i>	36	15	51	37.6
- <i>Product</i>	69	17	86	100.2
- <i>Demonstration</i>	5	6	11	2.9
Advanced Technology	14	20	34	3.9
IAP	119	121	240	49.7
IRIS	6	16	22	-
LPM	4	2	6	-
SAT-AIS	1	2	3	-
Total	298	260	558	195.9

Of the 293 projects funded through the C&G, AT and IAP elements (those where we have contract values), some stand out because of the scale of funding going to UK contractors. For example:

- The **Highly Adaptable Satellite (HYLAS)** project was undertaken through the Core Competitiveness Phase 3 (product) programme, with Airbus Defence and Space Ltd (UK) leading, in partnership with Avanti Communications Ltd (UK). The project (UK contract value 12.5 Million) sought to develop and demonstrate a series of innovative, new payload technologies and broadband data services to end users in Europe, launching and operating the payloads on the HYLAS satellite.
- The ongoing **Cassis project** (Connected Automotive Satellite Service Integrated System) is funded within the Core Competitiveness technology programme, with total UK funding of 8.5 million. The project is led by the Satellite Applications Catapult, but also involve 5 other UK partners: Satixfy, Riverbeck, the University of Swansea, Avanti and Viper RF. The project seeks to develop a low-cost automotive terminal in Ka-band, together with a payload suitable for installation on a number of microsatellites and high-altitude platforms. This will offer hybrid communication solutions to deliver high capacity connectivity to cars, small vessels and small aircraft.

3.1.2 Organisations involved

There are **approximately 208 unique UK organisations** included within our combined database of 558 UK participations, including half that have acted as primes in at least one project (sometimes also subcontractors in others) and the remainder that are only known to have participated as sub-contractors to other UK or, less often, non-UK project leads. The most frequent UK participants include:

- Airbus Defence and Space (46 prime or sub-contractor roles)
- EADS Astrium [subsequently Airbus Defence and Space] (25)
- Avanti Communications (24)
- Inmarsat Navigation Ventures (19)
- Com Dev Europe (14)
- Satellite Applications Catapult (13)
- Thales Alenia Space (10).

There are a further 78 UK organisations involved in 2-9 projects and a long tail of 120+ that have been involved in just one.

3.2 Programme relevance

From the stakeholder interviews conducted for this study, it is clear that ARTES is regarded as a **strategically important programme** for the development and growth of the UK space sector (technology, capabilities, overall size and value). The UK Space Agency (and others) are actively involved in programme governance, and in the selection of individual investments (with the exception of Future Preparations programme, where the UK approves the work programme and funding decisions are then made by ESA), seeking to maximise the relevance and benefits of investment for the UK.

Many of the stakeholders we spoke to highlighted that satellite communications and their application are a key **market segment for the UK and offer further significant potential for growth**. With the UK objective of capturing 10% of the global space market by 2030, being a leader in the evolving telecommunications market, and therefore being heavily involved in ARTES, is seen as crucial.

Representatives from both UKSA and Innovate UK reported that ARTES is **well aligned with the UK's** Space Innovation and Growth Strategy 2014-2030¹² and with the objective of increasing the UK's share of the global space-enabled market. The UK's space strategy also places a lot of emphasis on down-streaming and commercialisation, which are key elements of the ARTES programme.

Indeed, most of those consulted highlighted the strong **focus on industry and commercialisation** and were positive about the help that ARTES provides to companies in supporting their products and applications to market. Similarly, the industry-led nature of the programme was commended, as was the co-funding aspect, whereby businesses also have to make the internal case for investment.

Several interviewees suggested that the **UK had been at the forefront** of shifting the focus of the ARTES programme over time, from academic research to commercially orientated activities. Several mentioned that the programme's orientation towards commercial success could in part be attributed to the UK's influence on the programme historically (e.g. with the UK's Technology Strategy Board and Innovate UK amongst programme delegates). One also noted that if you take a leadership position (significant investment, close involvement) you are able to get much better leverage, and that steering the priorities of the programme would not be possible if the UK were a more junior participant.

More recently, the UK invested significantly into the ARTES IAP element, in part to facilitate the establishment of the **ECSAT facility** in Harwell, Oxford. This was a strategic investment to stimulate the potential for market growth in the area related to new companies, products and services, and the centre has proved important for the growth of a wider space cluster at Harwell.

Stakeholder interviewees also noted that a highly valuable attribute of the ARTES programme is the **flexibility** it allows each contributing country in terms of the projects they shortlist / select for funding. This allows countries to invest strategically, based on activities most relevant to national requirements. This positive view of ARTES flexibility was echoed by industry representatives, who reported that the programme allows them to propose activities in line with their own strategy and market opportunities, allowing them valuable flexibility and the ability to justify their own internal investment in a more robust and transparent way. As one put it "ARTES is always available when industry is ready", while elsewhere arbitrary call deadlines and evolving work programmes can be at odds with company plans.

Interviewees also agreed that the **balance of UK investment** and involvement across the ARTES programme was good, including across satellite technology, ground technology and applications. This breadth allows for a range of instruments that can be deployed for different scenarios to develop different types of solutions. For example, PPPs help to enable risk sharing partnerships between UKSA, satcoms operators and satcoms manufacturers, which is beneficial for the industry within the UK; while competitiveness & growth (C&G) and core competitiveness (CC) exist as flexible mechanisms to support more commercial and agile companies, and also enabling inward investments to the UK.

Several also expressed that it was important to consider when not to invest in a programme element, however, based on the relative speed of the market. Getting caught up in a slow cycle of ESA funding could be disadvantageous to companies who were under pressure to remain competitive in a rapidly moving market – but the UK is generally felt to have chosen wisely in where it invests.

¹² <http://www.ukspace.org/wp-content/uploads/2013/11/Space-IGS-Space-Growth-Action-Plan-2014-2030-Nov-2013.pdf>

3.3 Motivations for involvement

Around one-fifth of the UK contractors that have participated in the ARTES programme over the past decade were consulted through a CATI survey undertaken for this study, and they were asked about the main factors that had originally motivated their organisation’s participation. Their responses are summarised in the figure below (note, each could select more than one motivation for involvement), with the categories organised into three broad groupings: those relating to the project/company (blue); those relating to working with ESA (green); and those relating to access to other organisations (orange). Each of these broad areas, and the specific motivations, are discussed further below.

Figure 3 Main factors motivating the organisation’s involvement in the ARTES programme

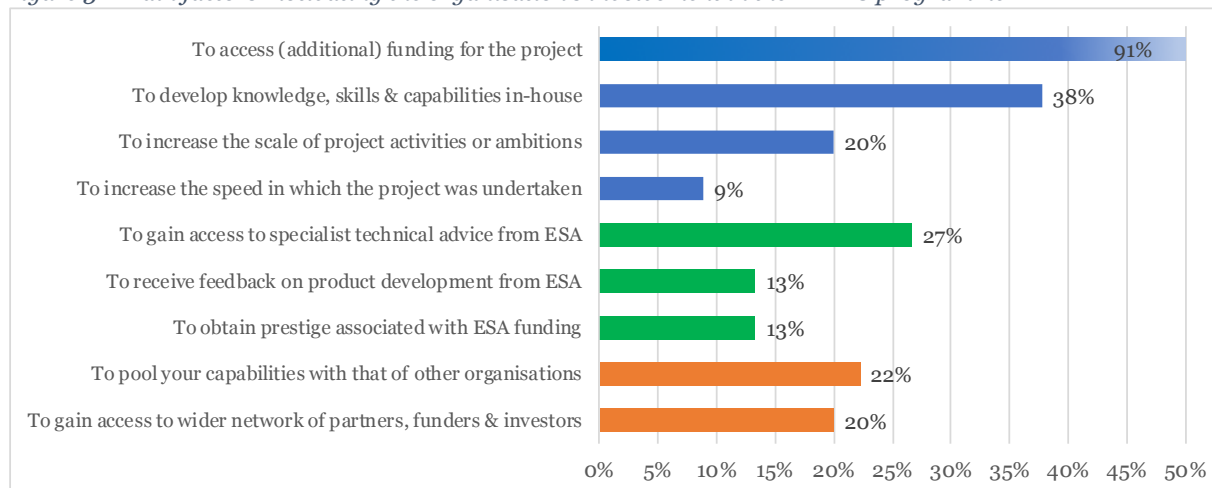

Source: Technopolis analysis of beneficiary survey (n=45)

It is clear from the results above that **additional funding** is a main driver behind most (91%) organisation’s original decision to seek to participate in the ARTES programme. Smaller proportions also pointed to the related motivations of increasing the **speed** (9%) or **scale** (20%) of the project activities that could be undertaken, where additional finance is likely to also be a key factor.

Indeed, most (76%) of the respondents went on to indicate that they would not have gone ahead with their project at all without the ARTES funding, suggesting this additional financial support had often been critical. Amongst respondents who believed their project may have proceeded anyway through other means, most felt there would likely have been negative implications in terms of a longer timeframe and / or a reduced scope for the project.

Some additional comments reinforcing the importance of the funding were provided. For example:

“We would not have been able to afford to further the project without funding”

“Without the funding, the timescale would have been too long-term to proceed”

“We would not have been able to cover the cost of the project without ESA”

“Without funding, we would not have been able to invest in the project, due to the risks involved”

“A key benefit of working with ESA [on the Iris PPP] is that it allows the implementation of projects that are of a scale (budget) that would not be possible otherwise, while also de-risking the private investment.”

Wider stakeholders consulted for the study also highlighted that co-funding through the programme enables companies to expedite high-risk and innovative activities, which might otherwise take significantly longer to advance if funded solely through internal R&D budgets. One also suggested that even for large UK organisations that are part of multi-national companies, the ARTES co-funding can help make the case for new developments (and internal investment) in the UK, rather than elsewhere.

More than a third of respondents to the survey pointed to one or more drivers relating specifically to the benefits of **working with ESA or an ESA programme**. This included access to specialist technical advice (a driver in 27% of cases), feedback on product development (13%) and, more generally, the prestige associated with working on an ESA project (13%). Again, some provided additional comment:

“We gained valuable expertise that has really helped with subsequent projects”

“Subject matter experts were very helpful, especially in areas where the company did not have extensive expertise”

“The ability to show that we worked alongside ESA provides more credibility to our organisation when looking to secure future contracts.”

Several interviewees, from both the public and private sector, also noted the particular added value of the experience, knowledge and technical expertise offered by ESA, above and beyond the obvious benefit of simply receiving the capital required to undertake a project. For example, some mentioned that the programme gives participating states access to ESA’s valuable market insights. The market insight from ESA also provides companies with the information they require in order that they can position themselves successfully within the EU market. It would not be possible, one person proposed, for the UK to run such a technically complex and large-scale programme with sub-components, on its own.

In addition, the ESA ‘seal of approval’ is thought to provide companies with the credentials necessary to be competitive within the marketplace. Stakeholders reported that having a mark that says you can do work to “ESA standard” is well recognised globally as a mark of achievement, helping to raise the status and reputation of participating industry and opening up opportunities for collaboration and exports. ESA’s social media, events and other promotional activities were also mentioned as additional factors that further enhance the reputational benefits of working with an ESA programme.

A relatively small proportion of survey respondents also indicated that **collaboration or networking** had been an important original motivator for their participation in ARTES – be that through the pooling of capabilities with others (22%), or through access to partners, funders and investors (20%).

Interviewees from both UKSA and Innovate UK confirmed that the added value of multi-national participation through the ARTES programme was likely to be limited because the majority of meaningful investments are made unilaterally. In most cases where UK organisations are working with other partners in their ARTES projects, these are also UK-based organisation. Indeed, a number of industry and government representatives that were spoken to mentioned that the facilitation of partnerships within the UK was the strength of the programme. They added that, while there is an aspect of convenience associated with the freedom to bring non-UK partners onboard where useful, experience of international collaboration suggests that this can complicate the scope of activities and slow progress.

However, stakeholders from industry also highlighted that, although the UK’s space sector is growing, it does not yet have all of the elements necessary to allow full capability. With this in mind, the multi-national component of the programme also encourages the establishment of international supply chains and acts as an enabler towards export. Indeed, many interviewees agreed that there was value in the multi-national nature of the programme, by facilitating wider opportunities for UK companies.

Finally, on a related note, stakeholders also highlighted that ARTES operates as a bridge between the UK and EU, and that this would likely become yet more valuable moving forward, as the UK leaves the EU. The Harwell Centre will also become even more significant, as the only ESA centre outside the EU. Connections through ESA, including through the ARTES programme, will continue to support the UK in forming collaborations, keeping in tune with EU policies and in helping to ensure alignment with other countries. One company also mentioned that ESA would be an increasingly important source of international R&D funding and collaboration, if UK industry is unable to participate in Horizon Europe.

4 Benefits and impact of involvement

This section concerns the assessment of the impact of ARTES. The overall purpose of the impact evaluation is to understand what difference the programme funding had made, in terms of the benefits and impacts for contractors, as well as for the UK skills base, space sector and economy more widely.

The section is structured around the main outputs, outcomes and then wider impacts that are intended or expected from the ARTES programme (see programme logic model, Figure 2), drawing mainly on the evidence collected through the survey of contractors, but also enhanced with views, examples and quotes taken from discussions with contractors and stakeholders and evidence from the case studies.

It is important to stress that at the time that ARTES participants were consulted for this study, most projects had only recently concluded or were still ongoing¹³. This means that the results presented are often preliminary and focused more on the immediate outputs and outcomes of participation; many of the benefits and impacts of the programme will only be realised and fully understood over the course of many more years. While we have asked participants to provide informed opinions about longer term benefits and impacts of the programme on their organisation and project idea / technology, there are obviously going to be limits on the extent to which respondents can know what the future holds.

The same is true of the case studies, which are highlighted at various points in this section and shown in full in Appendix C. While these were partly selected for inclusion because they provided early examples of successful outcomes from the programme involvement, it is clear that they are only that start of stories that will continue to unfold for many years yet. Ongoing initiatives, future plans and predictions for the future are often included, but these inevitably provide only a partial and incomplete view of the full long-term implications and impact of the programme.

4.1 Spin-ins to space

As the earlier portfolio analysis showed, the ARTES programme has attracted a very **wide range of participating organisations from the UK** over the past decade, including 174 companies, 27 universities and colleges and 7 other public research bodies and institutions. The companies range from SMEs with turnover in the tens of thousands of pounds, to large multinationals with £100m+ turnover¹⁴.

Most of the companies fall within three broad SIC codes: professional, scientific and technical activities (52 companies); information and communication (34); and manufacturing (26), although other sectors are also represented (administrative and support services, agriculture, other service activities, amongst others).¹⁵ Their space-related activities (self-reported through the survey) span:

- Space applications: the development of applications for satellite signals / data (58% of respondents)
- Space manufacturing: the design or manufacture of equipment and subsystems (24%)
- Space operations: the launch and/or operation of satellites and/or spacecraft (16%)
- Ancillary services: such as software, IT, market research and consultancy (13%)

Several of the stakeholders consulted for the study noted that the ARTES programme had also **encouraged new entities ('spin-ins')**, helping to support wider UKSA efforts to broaden, expand and grow the UK sector. This has been aided by efforts to simplify processes and paperwork, through the introduction of the kickstart initiative and by awareness raising activities. Even amongst the partial sample of participating UK organisations consulted for this study we identified a number that were new 'spin-ins' to the space sector at the time of their ARTES project.

¹³ We asked respondents to provide information about a specific ARTES project. In 67% of these cases the project had concluded within the past three years. In a further 17% of cases, the project was still ongoing. While there were many earlier projects included within the initial sample, it is more likely that contact information was out of date in these cases, and so they were underrepresented in the eventual responses (just 21% reported their project ended before 2016).

¹⁴ Information obtained from the FAME company database.

¹⁵ Information obtained from the FAME company database. Not all companies could be identified within the database, hence the total number of organisations with SIC codes (150) is lower than the actual number of participating organisations (174).

Of the 45 respondents to the survey, six (15%) said that they had not worked in the sector before their ARTES project. This included:

- A UK-based environmental consultancy that provides advice on the sustainable and legal sourcing of natural resources, with a focus on agricultural and forest commodities
- A tech start-up that combines space technologies and assets (e.g. relating to automation, artificial intelligence and machine learning) to bring efficiencies to protein production
- A telecommunication integrator that provides satellite products and services for military, broadcast and commercial applications.
- Providers of satellite mapping services and data [Proteus Geo, now merged with TCarta, and the focus of one of the case studies developed for this report – see Appendix C.4)
- An agriculture technology company, founded in 2014, that develops a technology to grow fruits and vegetables in arid conditions worldwide.
- A management and technology consulting firm, established in 2000

Other examples that were mentioned by stakeholders included:

- A drone manufacturer, that received support from ARTES to learn how to build satellite communication and navigation systems. This has helped the business move quite radically from aircraft manufacturer, to operator, to service provider.
- An international, non-governmental organisation dedicated to promoting responsible resource management. With ARTES support for a feasibility study (2012) and demonstration project (2015), the organisation has adopted space technology for the management of forestry and arboreal services.

Stakeholder interviewees also highlighted that a number of sectors ‘beyond space’ (e.g. insurance, transport, agritech and healthcare) are increasing their interest in and interaction with space-related data, or are recognising the value of utilising space applications and space enabled technology – and that activities in these areas are only expected to expand. UKSA actively participates in non-space conferences and industry events to discuss what the space sector can do in these industries and what the possibilities are – hoping to bring new people in and broaden the UK space sector as much as possible. This is also a key focus of ESA’s ARTES ambassadors programme, which the UK spends part of its subscription on. These ambassadors (the business applications UK ambassador platform is a network of 5 regional ambassadors) work with companies and individuals to develop their business ideas using space data and services and support their initial application into the programme. They particularly target non-space companies to highlight potential partnerships and encourage spin-ins to the sector.

Finally, it is worth mentioning that many other organisations – although they were already within the space sector – see an **increased focus on space-related activities** as a result of their involvement in ARTES. As will be discussed in more detail later, nearly all respondents reported that ARTES had improved the reputation and awareness of their organisation within the space sector, while two-thirds said that it had helped their organisation to expand its presence within space markets.

4.2 New and strengthened partnerships

The ARTES programme seeks to forge partnerships within industry¹⁶ and indeed nearly three quarters (73%) of respondents to our survey said that their ARTES project **involved collaboration with at least one other organisation**. Across the projects covered by respondents, there were between 1 and 4 organisations involved in each (2.1 per project on average), including the responding organisation.

In a quarter of cases where other partners were involved (8 of 33, 24%), the respondent reported that at least one of these partners was *new* (i.e. they had never worked with them before the ARTES project). There were 10 **new partnerships established** in total across these projects. If similar patterns were to hold across the wider portfolio of 375 ARTES projects with UK involvement, then we can estimate that around 73 *new* collaborations between UK organisations will have taken place in total¹⁷.

¹⁶ <https://artes.esa.int/about-tia>

¹⁷ 375 projects, of which 73% were multi-partner (i.e. 274). Of these, 24% (i.e. 66) involved at least one new collaboration, with 1.1 new partners on average – resulting in the estimated 73 new partnerships.

Nearly all of the organisations that had worked with at least one partner in their ARTES project (27 of 33, 82%) also reported that their **relationship with the partner(s) had been strengthened** during the project. They were split evenly between those who felt the relationship had been strengthened ‘to a small extent’ and those who felt it had been strengthened ‘to a large extent’.

Furthermore, a quarter (24%) of all respondents pointed to ‘strengthened relationships’ as one of the two **most important benefits** that they had realised through their involvement with ARTES.

It is worth noting that beyond the formal sub-contractors and partners in the project, there may also be wider supply chains in the UK benefiting from ARTES contracts. For example, Airbus reported that for their Quantum programme (an ARTES PPP) there are only a few UK SMEs directly involved – but then there are 20+ suppliers to the company that are already part of developments.

Similarly, Inmarsat highlighted that the PPP set-up allows the incorporation of companies operating in various sectors. The **Iris PPP** (one of the case studies developed for this study) is being undertaken in collaboration with a wider range of companies operating in the downstream sector, as well as outside of the space sector entirely. For example, the development of the service has been done in partnership with key players from air traffic management, air transport, aeronautics and the satcom industry, including Airbus, Boeing, and Thales Alenia Space, together with an airline. Other UK partners, working with Inmarsat include CGI IT UK Ltd, Helios Technology, Honeywell UK, NATS (En route) plc and SITA Information Network Computing UK Ltd.

Another of the case studies developed for this study provides a slightly different example of partnership strengthening. ARTES funding for the development of a satellite derived coastal bathymetry portal incentivised the merger of Proteus Geo (UK) and **TCarta** (US), whose existing work in undersea mapping and bathymetry datasets were highly complementary. Both firms also invested €1M in the project, diverting profits to match the programme investment. This project has also led to another partnership, this time with King’s College London (KCL), to develop a similar online platform for satellite derived air quality data. Again, this further development is supported through ARTES.

4.3 New and improved knowledge, skills and capabilities

Investigating and understanding technologies, plus creating new and enhanced capabilities within the space sector, sit at the heart of the ARTES programme, and this is one of clearest outputs to come from ARTES involvement amongst the UK organisations we surveyed. All of the 45 contractors consulted said that ARTES participation had led to **improved internal knowledge, skills and capabilities**, including two thirds (31, 69%) who cited a large improvement in this area. Most (32, 71%) also indicated that this was one of the two most important benefits they saw from their involvement in the programme.

Some elaborated in more detail about their knowledge improvements. For instance:

“We gained valuable expertise from ESA which really helped for future projects”

“We got the opportunity to learn about the ARTES programme and how to develop and pursue other opportunities”

“We gained insight and knowledge from our other partners”

Most respondents (89%) also claimed to have used their new knowledge and capabilities (developed through their ARTES project) **in other areas of their business**. For example:

“Increased engineering expertise – with wider applicability”

“Improvements to level of data analysis throughout business”

“Re-use of programmes developed for other projects”

“Improved project management capabilities”

“Broadened horizons - encouraging us to look for other opportunities”

“Improved software tools, resulting in increased/better data analysis”

One of the case studies provides a further example. **SatixFy** reported that it was able to leverage new knowledge gained as a result of ARTES funding in other development projects. For example, based on the knowledge gained during the early development of two new ASICs, they made new connections which led to the development and release of a new advanced satellite communication modem, alongside the new chips that were the focus of ARTES funding. Both now form part of their expanding portfolio of products.

4.4 Codified knowledge and knowledge transfer

While much of the new knowledge, skills and capabilities developed through the projects will rest within the organisations and staff concerned, projects also engage in various activities to codify, disseminate and transfer the new knowledge developed beyond the specific project and outside of the organisation.

As shown in Table 3, one-fifth (18%) of respondents to our survey reported publications in **referred journals** (5 each on average) resulting from their ARTES project, while a similar number reported **other types of publications**. Over a quarter (27%) also reported that their work had led to other **dissemination activities** – either to other parts of their organisation, or at external SATCOM-related events. There were three **patent applications** reported by one respondent in our sample.

The final column of the table provides an approximate estimate, based on the responses given, of the number of each of these outputs that one might expect to see from a sample of 100 ARTES projects. This suggests that every 100 ARTES projects with UK involvement might result in around 90 refereed papers, another ~25 publications, ~40 other dissemination activities and 5-10 patents.

Table 3 Outputs generated by survey beneficiaries

Output generated	No. reporting output	% of all respondents	Total number of outputs reported	Estimated outputs per 100 projects
Publications in referred journals	8	18%	39	87
Other publications	7	16%	11	24
Other dissemination activities	12	27%	16	36
Patent applications	1	2%	3	7

Source: Technopolis analysis of beneficiary survey

4.5 Raised TRL levels

ARTES seeks to **support the development of technology and ideas**, helping to accelerate innovation and to progress products along the Technology Readiness Level (TRL) scale (see below). A number of the stakeholders consulted for the study noted the high frequency with which ARTES projects led to progression in TRL. The core competitiveness programme in particular was highlighted, as it is specifically structured to facilitate progression towards commercialisation (funding proof of concept and product development, through to demonstration), but most activities across all elements of the programme were thought to have a high success rate in terms of TRL progression.

Figure 4 Technology Readiness Levels (TRL)

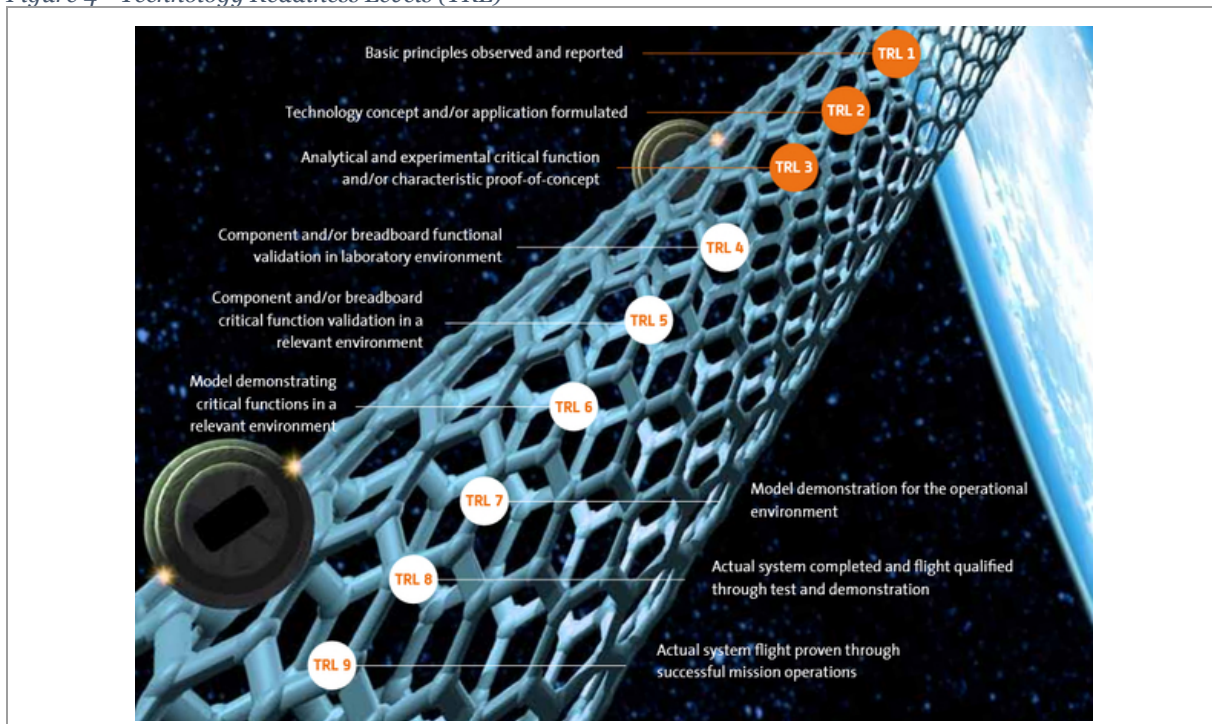

Source: ESA

We explored the extent of TRL progressions through our survey of ARTES beneficiaries. The sample of projects covered included those that were at TRL 1 or 2 at the time of application (64%), as well as some at TRL 3 or 4 (33%) and TRL 5 or 6 (3%). Of the respondents who could indicate, 89% said that there had been an **increase in TRL levels** between the start and end of their ARTES project. As shown below, this includes all (100%) of those whose idea or technology was at TRL 3 or above at the time of application. Indeed, in most of these cases the project reached TRL 7 or 8 (model/system demonstration for the intended environment). The vast majority (82%) at the lowest TRL levels (1-2) also progressed.

Figure 5 Progression of TRL levels amongst respondents

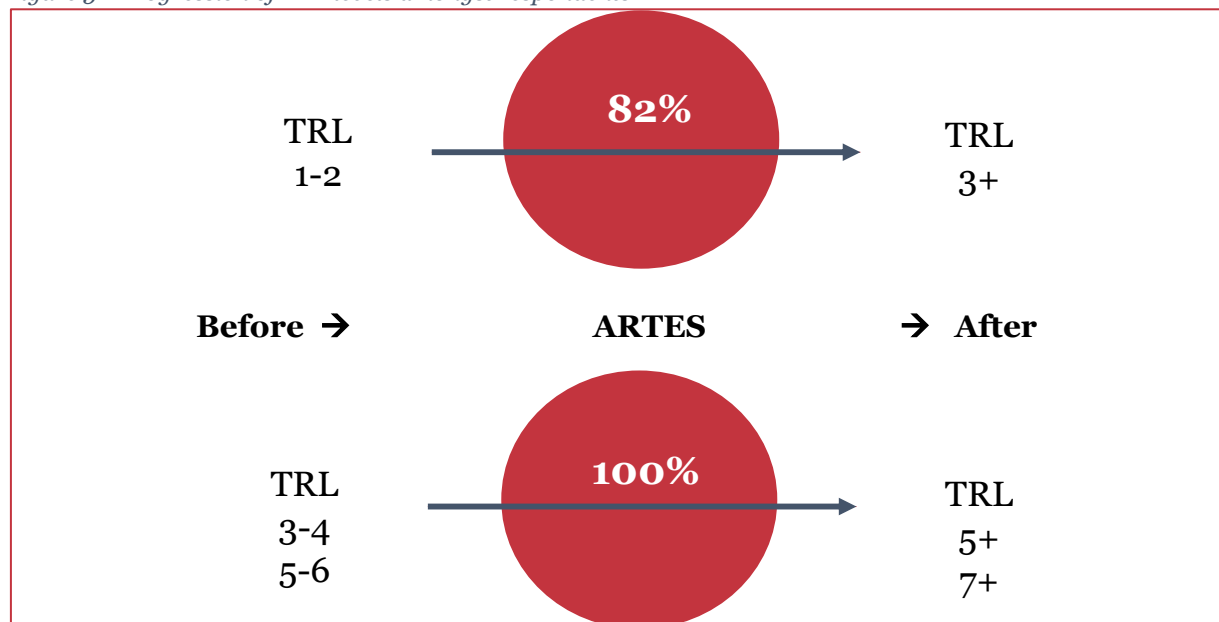

The case studies provide several clear examples of ARTES funding supporting the progression of projects and ideas through the TRL levels.

For example, **SatixFy** conceived of two new application specific integrated circuits (ASICs), capable of managing multi beam electronically-steered radar array. These would eliminate the need for traditional types of antennae, offering compact, light-weight and scalable circuit boards that could dramatically reduce production and launch costs. The ARTES funding that the company received was reported to have been essential for moving this concept forward and the company successfully created an engineering sample within their two-year project. The two new ASICs came to market in November 2018 and the first product based on these (a 256-element antenna), was released in February 2019.

Another case study, on **TCarta**, describes how the company used ARTES funding to develop a global database and online portal, providing access to satellite derived coastal bathymetry. Proteus Geo (which merged with TCarta for the project) was already working on the development of bathymetry databases, but the ARTES funding was said to have been critical, enabling the firm to move forward with the project far more quickly than would otherwise have been possible. In addition to the beneficial injection of funding, the programme requirement to create the Portal by the end of the project period was also felt to have kept the development team focused and on track, despite the pressures of other projects and clients. The company estimates that it would have taken 3-5 years to complete the project on their own, 50%-70% longer than was achieved with ARTES funding. At the speed their industry moves, TCarta believe it is likely that they would have missed their opportunity had they continued to develop the portal without external support.

4.6 Continuation of partnerships and collaborations (beyond the project)

By encouraging the formation of new partnerships, as well as through the strengthening of existing ones (as described in sections above), it is hoped that ARTES will also support strategic partnerships and collaborations within the UK space sector to continue, *beyond* the life of the individual projects.

We discussed earlier that there were seven examples of **new partnerships** formed within the sample of 45 projects addressed through our survey (and that we might extrapolate to ~64 such new collaborations being formed across the wider portfolio of ARTES projects with UK involvement). These new relationships were all found to have continued, in some form, beyond the life of the project.

Other contractors that were surveyed also commented on the **endurance of various relationships** that were developed through ARTES projects. For example:

“We worked again with partners, where relationships were developed in ARTES”

“We partnered with high profile organisations, which have led to ongoing links”

“We are still working with SMEs that we first worked with through the project”

“We are still working with partners from this project on a current ARTES project”

“We still communicate with our project partners on a formal and informal basis to this day, despite the fact that the project was almost a decade ago”

“We forged partnerships through the project with numerous organisations (potential clients) that will be useful in future years to come”

A large number of respondents also highlighted that their participation in ARTES had helped open up other new collaboration opportunities. Some 91% of respondents (39) believed that their involvement in the programme had improved the **attractiveness of their organisation as an R&D partner** in the space sector – including 28% who said it had done so to a large extent. For 18% of respondents (8), this increased attractiveness as an R&D partners was a key benefit of their involvement. For example:

“The project allowed us to demonstrate our ability to be versatile and adaptive while working with a global player”

“We will use this project as an example of our attractiveness as an R&D partner, in the space sector and beyond”

4.7 Increased visibility and reputation of UK capabilities

Most contractors reported that ARTES participation has improved the reputation, visibility and / or awareness of both their project idea or technology, and (more generally) their organisation: 84% believed that ARTES had improved **visibility and awareness of their project idea or technology**, including 20% who said it had done so to a large extent; while 89% believed that ARTES had improved **awareness and reputation of their organisation** in the space sector, including a third who felt it had done so to a large extent. Additionally, 38% of respondents (17) stated that the improved organisational reputation was one of the two main benefits associated with ARTES involvement.

Figure 6 Improvements to reputation, visibility and awareness through ARTES projects

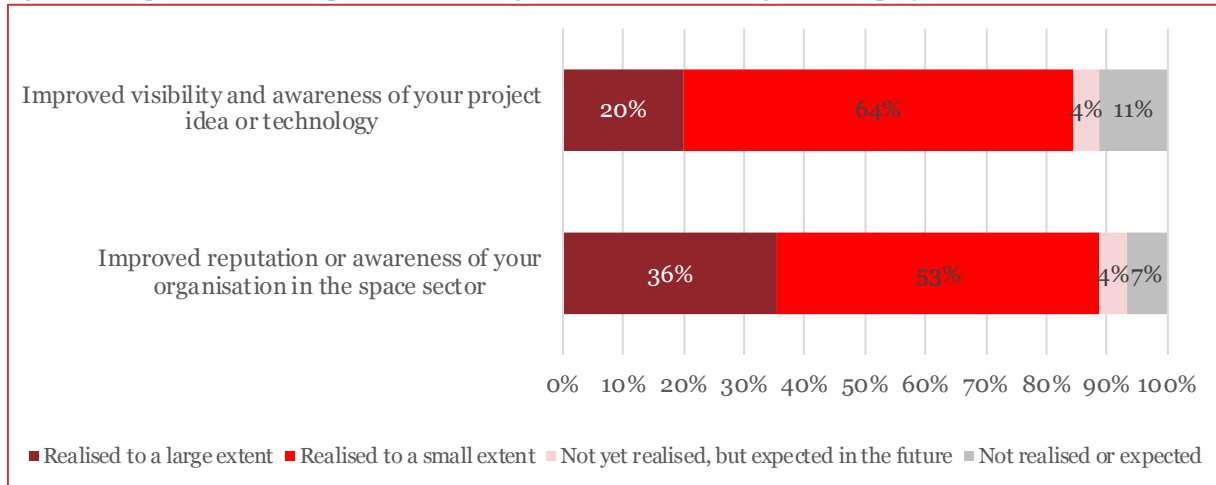

Some respondents also mentioned more specifically how increased organisational reputation had **opened up commercial opportunities**. For instance:

“The programme has allowed us to gain access to a much broader range of technical clients. We are now one of the top two suppliers in our field”

“One main reason for participation in the project was to demonstrate our organisation’s abilities and to gain recognition within this sector”

“Working with various partners within the space sector, we were able to network effectively and gather useful contacts”

“We have now established a strong presence in the UK space market, and the ARTES project was a critical step in gaining a foothold.”

“The project improved our reputation, which will make it easier to secure future funding – a necessity for the ongoing existence of the department”

One of the case studies provides a further, more detailed example. **TCarta’s** experience during the ARTES Bathymetry Portal project proved that they were capable of delivering projects that are global in scale. Their confidence propelled them to bring more aspects of the development process in house, making them a one stop shop for satellite derived data and platform development. ESA also aided TCarta with the production of videos and other promotional material linked to the original Bathymetry project, which dramatically increased TCarta’s exposure. The company was also asked to present at ESA events, which had a similar impact on the brand. The Portal itself has also proved to be a very successful marketing tool for the company. The company reported that many clients have got in contact after finding the Portal online, allowing TCarta to discuss their needs in more depth and provide custom data.

Most respondents to the survey also reported positively on the impact that ARTES participation had had in terms of their **organisation’s future prospects in the space market**. For example, by:

- Increasing their attractiveness to institutional / commercial funders (reported by 89%)
- Increasing the likelihood that they will secure contracts in the space sector (79%)
- Increasing the likelihood that they can expand their presence in space markets (72%)

Figure 7 Impact of ARTES involvement on future prospects in the space market

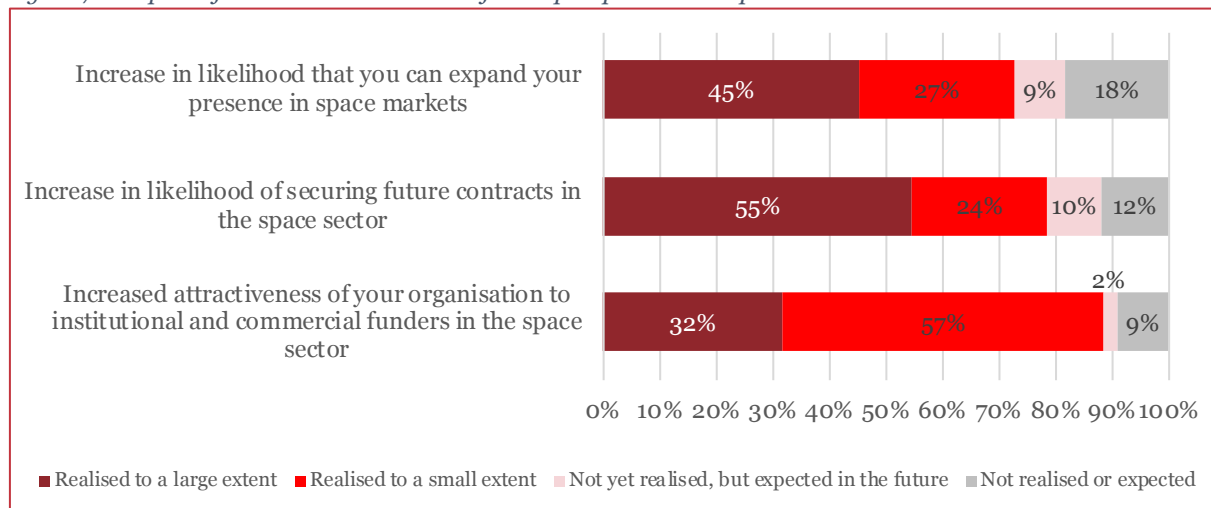

Around half of respondents pointed to the increased attractiveness to funders and / or increased likelihood of securing future contracts as being one of the key benefits of their ARTES involvement. Some additional comments were provided on this point:

“The project opened up new commercial opportunities”

“We won our next contract on the basis that we had a proven collaboration”

“The completion of this project has helped us to gain grants in other areas of development, such as a global accelerator programme in Silicon Valley”

“Participation in ARTES has assisted us in winning key contracts with other clients”

“We have won further contracts relating to spin off technologies”

“We gained increased visibility and access within the public sector, enabling us to communicate more intelligently with this customer base”

4.8 Projects de-risked for further investment

As well as awareness and visibility for the UK space sector and its technologies, the ARTES programme also supports the development and demonstration of project ideas to the point at which they are de-risked for further investment elsewhere, whether that be via other grants, internal funding, or through institutional or commercial contracts. Space is often a risky, long-term venture that dissuades investors from financing early-stage technologies, and the programme can help address this critical funding gap.

As the following table shows, nearly two thirds of respondents to our survey claimed that their ARTES project had resulted in the **demonstration** of their technologies or concepts, while over half said that **new or improved technologies and products** had been achieved. In two of the cases covered in the sample, the project resulted off-the-shelf technology being made available (one provided further detail, explaining that the new technology was a system that is able to provide timely notification and prediction of the presence of birds near civil airports), while a further 20% reported some form of **spin-out created** as a result of the project.

Table 4 Outputs generated by survey beneficiaries

Output generated	No. reporting output	% of all respondents	Total number of outputs reported	Estimated outputs per 100 projects
Technology or concept demonstrations	28	62%	38	84
New or improved technologies/products	25	56%	28	62
Off the Shelf Commercial application services or technologies	2	4%	11	24
Spin-outs created	9	20%	11	24

Two thirds of respondents (67%, 29) went on to say that ARTES had helped **de-risk their project for further investment**. In addition:

- 86% of respondents (38) claimed their ARTES project had led to a **reduction in the cost** of their project idea/technology – with one third (34%, 15) indicating this had been realised to a large extent.
- 78% of respondents (35) claimed that ARTES had led to a **reduction in time to market** for their project idea or technology – with one third (33%, 15) indicating this had happened to a large extent.

Some of the comments provided alongside these answers are shown below as examples:

“Artes allowed us to develop our model much further, to the point that we will produce the product within the next 12 months and begin to receive substantial income as a result”

“ARTES led to a much-reduced timeframe to develop the project from initial idea”

“ARTES enabled us to kickstart a project and provided a route to the next step. We are now working on turning the prototype created into an end product”

“The funding enabled the organisation to focus on one project and progress much quicker”

Another clear example is provided by the case on **Oxford Space Systems**, which has used ARTES backing to tackle high-value product development. ARTES provided critical co-funding to unlock venture capital investment, particularly in the early years of the company – enabling it to undertake the more expensive, longer-term and riskier projects that investors would typically avoid. In late 2018 OSS secured its third and biggest round of VC funding, £7.9M, making it the most highly funded UK start-up, upstream space technology business. In fact, since 2014, OSS has received more than £12m in private capital investment. The growing success of these public funding calls is an endorsement of ARTES support and a strong indication the company is moving toward commercial success.

4.9 Generation of additional contracts and revenue

Stakeholders noted that progress towards ‘success’ can be slow within the telecommunications industry and often projects stall, but then gain momentum soon after. In such instances it can be difficult to tease apart whether or not a project has truly failed or has just not had long enough to achieve success yet.

Nevertheless, more than half of our survey respondents (58%) reported that their organisation is **already generating new income** through the developments supported through the ARTES programme, while many others (29%) are expecting this to be the case in the coming years (though with differing levels of confidence). Only 6 respondents (13%) reported that *no* new income was expected. In four of these cases this was because the project showed a lack of feasibility – which is not an unexpected result from some proportion of the projects funded. Contract values are available for two of these four projects, showing that they both involved only small-scale investment (contract values of £25k and £60k). In the other two cases where no new income was expected, we were told this was because another partner in the project took the idea forward (rather than the organisation we spoke with).

The widespread generation of income (and likelihood of other projects generating income) is an impressive outcome for the programme, when one considers that a certain level of failure is expected when many projects are (by design) exploring unproven technologies and testing feasibility.

Figure 8 Likelihood that developments supported through ARTES will lead to new income (n=45)

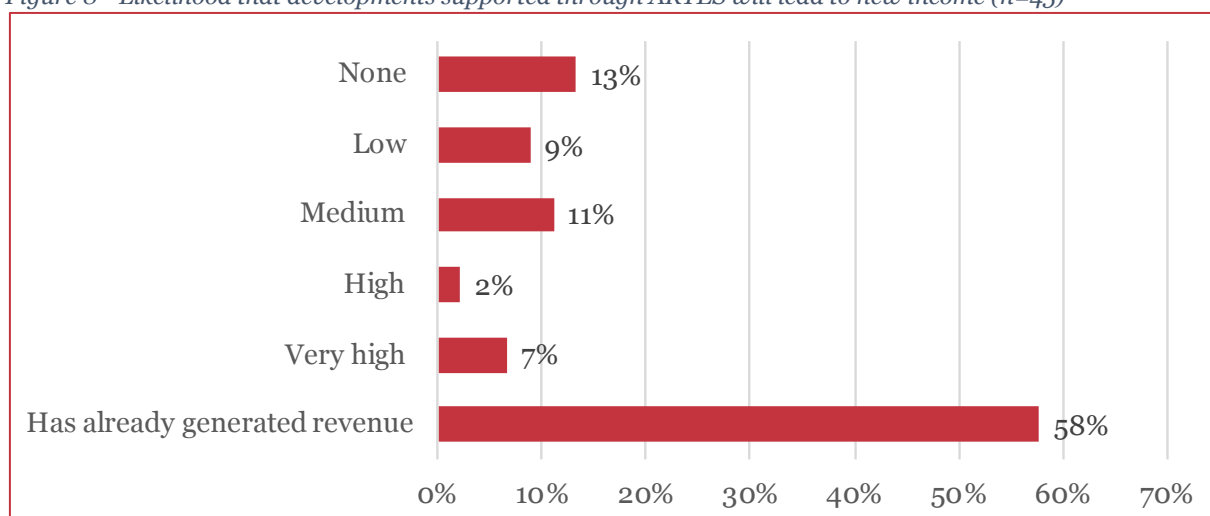

Source: Technopolis analysis of beneficiary survey

Of the 26 respondents reporting that they were **already generating additional revenue**, only around half could or would provide further details of the scale of income realised so far, or that was expected going forward. Also, many were happier providing wide bands (e.g. £1-5M), rather than specific figures (some also preferred to answer in Euros, others in Pounds). The following table summarises the inputs that were provided.

Despite this being an incomplete picture, it already provides some sense of the income generation potential of ARTES projects. For instance, the responses from 13 of the 26 organisations generating income already show that they have generated around £30M in the past year or two¹⁸. In addition, the responses from 16 of these organisations suggest that over £110M is predicted over the next five years.

In the majority of cases, the income generated so far has come from commercial sources (B2B or B2C), with only a handful of respondents suggesting some of their income has come from other sources (UKSA, ESA and the European Commission). For most, this income also tends to be split between UK and other European sources relatively evenly, with only a few pointing to non-EU income.

Table 5 Income realised and expected by those already generating income

Project end year	Income generated by 2017/18	Predicted income for next 5 years
2016	£20K	<not known>
2012	<not known>	£15M
2018	<not known>	£10-15M
2017	<£1M	<£1M
2018	<€1M	€1-5M
2016	<not known>	€1-5M
2017	£1.3M	£20M
2018	€500K	€2.4M
2018	£100K	£500K
2016	£50K	£1-5M
2018	<€1M	<not known>
2018	<£1M	€1-5M
2017	<not known>	£10-15M
2016	<not known>	€5-10M
Ongoing	£500K	£15M
2016	€250K	€1.25M
2014	£7M	£20M
Ongoing	€20M	€20M

¹⁸ We have used the mid-point where a band was given.

The 13 organisations who **may generate income in future** (but have not yet done so) were also asked about the probability, the timescale and the likely scale of income that they might see. Their responses are shown below and suggest another ~£15M in projected future income (although with varying levels of confidence). In section 5, the three assessments (likelihood, timescale and value) are combined to assess the past future revenue generation of the UK ARTES project portfolio.

Table 6 *Income expectations by those not yet generating income*

Project end year	Likelihood of future income	Timescale for start of income	Likely income over 5 years
2016	Very high	1-2 years	£3.5M
Ongoing	Very high	3-5 years	£1-5M
2016	Very high	1-2 years	<£1M
2018	High	3-5 years	<£1M
2018	Medium	<not known>	£1-5M
2016	Medium	1-2 years	<€1M
2018	Medium	<not known>	<€1M
Ongoing	Medium	1-2 years	<€1M
2018	Medium	<not known>	<£1M
2017	Low	3-5 years	<£1M
2017	Low	1-2 years	£1-5M
2018	Low	3-5 years	<£1M
2015	Low	<not known>	<£1M

The case studies developed for this evaluation also provide a number of good examples of ARTES projects leading to follow-on funding and commercial revenue. For instance:

- **Oxford Space Systems** has participated in four ARTES projects over the course of the past 5 years, resulting in commercially viable products and materials that are now on the market. ESA funding essentially provided the company with a seal of approval in the eyes of its competitors, investors, customers and government, and OSS has recently secured collaborations with Airbus, Thales and LuxSpace, alongside several rounds of VC funding (more than £12m in private capital investment over four years). The firm now has a number of core product lines and is approaching profitability.
- **Spire Global** is using ARTES Pioneer funding to become a complete Space Mission Provider (SMP). ARTES supported the company to develop and launch two new satellite systems with unique payloads to provide validation for parallel computing in space and for the exploitation of Global Navigation Systems Radio Occultation (GNSS-RO) signals for weather applications. The satellites were ready for launch just 6-months after award and within one week of deployment they were harvesting GNSS signals to provide frequent low earth orbit weather data (temperature, pressure, humidity). On top of their development into a SMP, ARTES funding has supported Spire in the development of potential new revenue streams (radio occultation data and parallel supercomputing in space). Both offer unique and higher quality data to their customers, and Spire estimate that the new weather data alone will be worth \$2.7 billion to the company over the next 25 years.
- ARTES funding was used by **TCarta** to develop a global database and online portal, providing access to satellite derived coastal bathymetry – i.e. water depth measurements by satellite – based on techniques developed by the firm. The portal is now live and allows customers to purchase data online, anywhere in the world, at any time. It is being used in a wide variety of areas, including engineering, construction, government data and the oil and gas industry. This has changed the company's business model from being dependent on individual projects to one where institutional and business clients pay to find and download data whenever they require it. This additional business has enabled it to increase in size, from 10 to 27 employees (including 13 in the UK). The original bathymetry project has also led to further collaborations and funding in other related areas. For example, TCarta is working with Kings College to develop a similar online platform for access to satellite-derived air quality data.

- **Remote Diagnostic Technologies (RDT)** used ARTES funding to expedite the development of a diagnostic, monitoring and telemedicine unit that uses satellite communication and navigation capabilities. The product Tempus Pro was cleared for market in 2013 and has already been sold to a number of NATO militaries, as well as companies in the oil and gas sector. Subsequent ARTES funding for a follow-up phase is helping to develop related products for broader implementation (e.g. in the context of civilian pre-hospital care). This includes the Tempus LS defibrillator, which has been adopted by, amongst others, the UK Helicopter Emergency Medical Services and the Dutch Ambulance Service. In 2017, RDT also launched the Tempus ALS system, which combined the monitoring capabilities of Tempus Pro with the Tempus LS defibrillator, to provide an integrated solution. The solution has allowed RDT access to the \$4 billion civilian pre-hospital monitor defibrillator market, with the company's annual turnover increasing from £10.3M in 2016 to £17.6M in 2018. In 2018, RDT were then wholly acquired by Philips Healthcare (for an undisclosed price), with RDT's now extensive portfolio of emergency care solutions neatly complementing Philips' Therapeutic Care business and strengthen its position in the €1.4 billion resuscitation and emergency care market
- **Rezatec** is a geospatial data analytics company that has received several ESA grants to develop their mapping and data services. An initial ARTES-funded feasibility study (Peat Spotter) created a satellite-derived service for sustainable peatland management and conservation. However, discovering that their monitoring services could also be applied elsewhere, further ARTES funding was then used to develop the M3i (map, measure and monitor) service for assets across water, forestry, conservation and agribusiness sectors. This has developed into a multi-million-pound revenue stream (the company estimates £10-15M in income over the next 5 years) and supported new equity funding and expansion into new satellite offices in North America and Ireland.

Other examples were given through the stakeholder interviews (though these don't necessarily relate to the period in scope for this study):

- **Airbus** provided a specific example of a particularly successful ARTES project in terms of ROI. This project involved developing digital process payloads, with a UK ARTES investment of £5.8M (including co-funding). As a direct result of this project, Airbus were able to win 2 large contracts from SES of Luxembourg (for SES12 and SES13) with large UK work orders (50% of the satellite building was completed in other EU states, while half came to the UK) valued at over £200M. This represents an ROI of greater than 30:1 for the UK and was a major export success. For Airbus, ARTES has been pivotal to securing contracts like this and without such funding Airbus would struggle to remain competitive within the market. Airbus suggested that there were also other examples they could give of significant return, but the details were currently commercially sensitive.
- A particularly successful example (provided by the Satellite Applications Catapult) was the **Skynet 5 Payload System**, which was originally developed with ARTES funding. This turned into a 3-billion-pound service that has been delivered to the MOD over the last 15 years. The UK military satcom system is already 15 years old, but is still one of the best in the world.
- The Satellite Applications Catapult reported that an ARTES-funded project on illegal fishing led to a **spin out company (Ocean Mind)**, which turns over ~£1.5M currently and is growing fast. A related activity is also underway looking at tracking overfishing and illegal discards of fish catch.

4.10 Growth in the UK space sector

The surveyed UK contractors were also asked about the **longer-term implications of their participation** in ARTES projects, and what the impacts might be in relation to various aspects of their organisation and its commercial success. The following figure shows a summary, indicating the proportion of respondents foreseeing a medium or high impact on their business, and the proportion foreseeing low or no impact. A majority suggested that there would be significant (medium/high) impact in most of the areas suggested. In particular, at least two-thirds foresaw significant impacts in terms of their reputation, productivity, profitability and turnover. Most also expected to see increased national and / or international competitiveness. Smaller, but not insignificant proportions, could also foresee a medium to high impact on their market share attributable to their past ARTES project.

Figure 9 Longer term impacts of ARTES projects on participating UK organisations

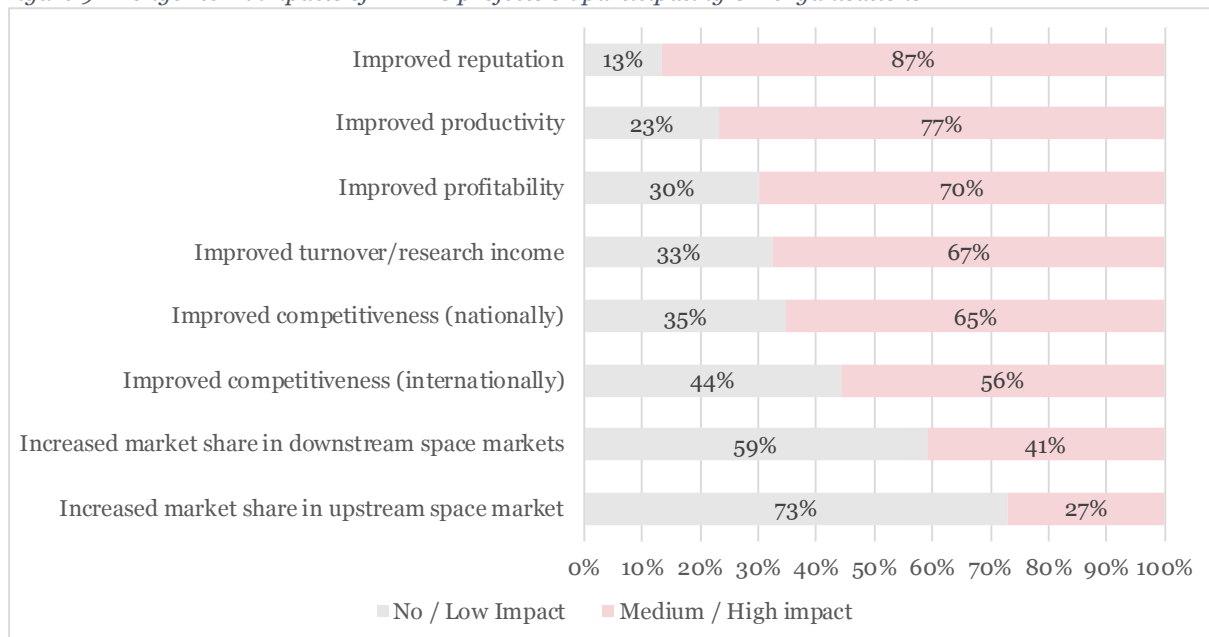

Stakeholder interviewees were clear that (significant) UK investment in the ARTES programme had helped **demonstrate a long-term commitment** to invest in space technology and support the space sector. The programme is regarded as strategically important for the UK and an important basis and driver for growth in the UK space sector – especially in the ‘new space age’, which the UK is looking to lead. The programme is felt to have provided **an important mechanism for UK space**, facilitating large-scale R&D investment in satcom, improvements to UK technical capabilities, consolidation of UK leadership in telecommunications and growth in both the value and size of the UK space sector.

A number of stakeholders also highlighted specifically the important role that the ARTES programme had played in the UK’s ability to **attract inward investment**, by attracting companies to establish in the UK, by encouraging multi-nationals to invest in their UK-based business, and through attracting further funding, investment and revenue off the back off ARTES projects.

One of the case studies developed provides a clear example of such inward investment to the UK to take advantage of ARTES investment. **SatixFy** are a satellite communications company, originally from Israel, but ARTES funding was enough to convince the company to establish itself in the UK. As mentioned previously, the first of many planned products (a 256-element antenna), based on chips developed with ARTES funding, was released to the public in February 2019, while a new advanced satellite communication modem was also developed and has been released off the back of the project. The increase in new products (including these payload solutions and advanced modems) has led to an increase in the company’s UK staff, from 27 to 77, spread across two design centres in Manchester and Farnborough. SatixFy has also invested €15M into these centres (IP, personnel and infrastructure) in preparation for new products and future growth, demonstrating their ongoing commitment to the UK.

Another example, put forward by stakeholders, is OneWeb – a US-led consortia that established their headquarters in London, reportedly in part because of ARTES opportunities. The organisation made a strategic investment in their UK operations, employing around 120 staff.

Stakeholders also noted that the ARTES programme helps to **keep the “brightest and best” companies in the UK**. They reported that the UK’s significant and consistent investment in the programme helps to anchor key industry players here, enable them to undertake higher-risk innovative R&D, and also to pull through a whole supply chain of businesses. Indeed, stakeholder interviewees from industry agreed that membership of ARTES creates a conducive environment and favourable framework for the space sector in the UK, which is attractive when planning long term investment.

The opportunities provided through programme also help the UK to keep and nurture newer, smaller enterprises. Stakeholders mentioned Clyde Space and Open Cosmos as clear examples of this. The case studies also include organisations that have quickly grown from micro- to medium-sized companies, in large part through the support they received through the ARTES programme. For example:

- **Oxford Space Systems**, established in 2013, brings an entrepreneurial approach to the development of deployable antennas and other structures for satellites, innovating to reduce complexity, development times and costs. With ARTES funding it set a record for the space sector, going from company formulation, new material development through to successful on orbit demonstration in just a few years. The company, headquartered in its own custom facility at the Harwell Space cluster, has grown quickly from 3 to 47 employees. Despite now having a number of products on the market, the company also continues to innovate aggressively, modifying its technology to meet bespoke needs for satellite builders globally.
- **Spire Global Inc** (a Californian firm) expanded into Europe by opening an office and manufacturing facility in Scotland with support from UKSA. It was then awarded £4m (€4.9m) of funding through the ARTES Pioneer programme, as part of ESA’s mission to develop companies into Space Mission Providers (SMPs) that are able to offer a broad spectrum of capabilities and competencies, alongside the infrastructure necessary to run satellite operations. Even with a successful proof of concept, companies often face long delays before an opportunity for in-space validation arises – and Spire is the only company in the UK launching satellites every few months, eliminating the long wait. The flexibility offered by Spire, will allow the burgeoning space sector in the UK to continue its growth. From an initial team of 10 in 2015, the company itself has also grown rapidly to 57 staff (March 2019) and invested £20 million into their local business infrastructure. There are also further opportunities for growth, with news that the UK will be developing a new spaceport in Scotland. Spire will then have the capacity to design, build, test, launch and operate their satellites in the UK. Although still a few years away, Spire is already excited about this prospect.

4.11 Benefits to the wider UK economy and society

Space is increasingly seen as a component of national infrastructure, rather than a stand-alone sector, within the UK. It is an enabling sector that has an impact across the whole UK economy. This is particularly evident within the IAP and PPP elements, where the link to other markets and sectors is often more immediate, but can also be true across all aspects of the ARTES programme.

Nearly all respondents (78%) to our survey of UK contractors reported that the products or systems developed through their ARTES project **benefited end-users**, and, as shown below, these end-users fall within a wide range of areas and sectors – including, most commonly, environmental monitoring.

Figure 10 Products or systems developed through the project benefit end-users in ... (n=45)

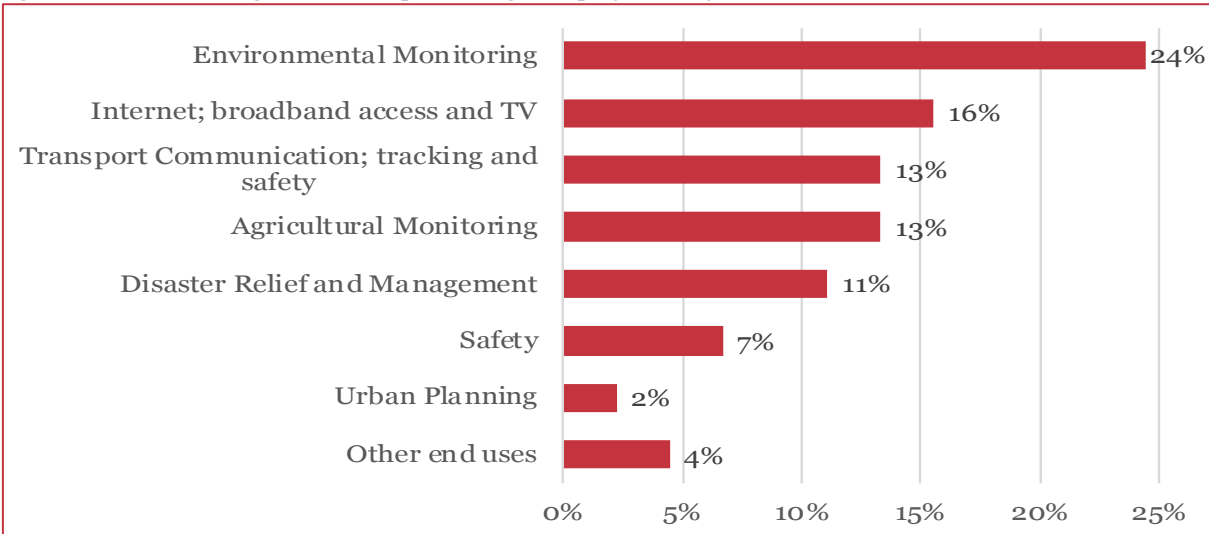

Source: Technopolis analysis of beneficiary survey. Note that figures will not sum to 100% as some respondents indicated more than one end user

The **advantages offered** by these new products or systems, compared with existing solutions, are also wide-ranging. This included, most frequently, the provision of more accurate information or entirely new capabilities, as well as enhancements to the usability of existing technologies.

Figure 11 Advantages offered by the Satcom technology (n=37)

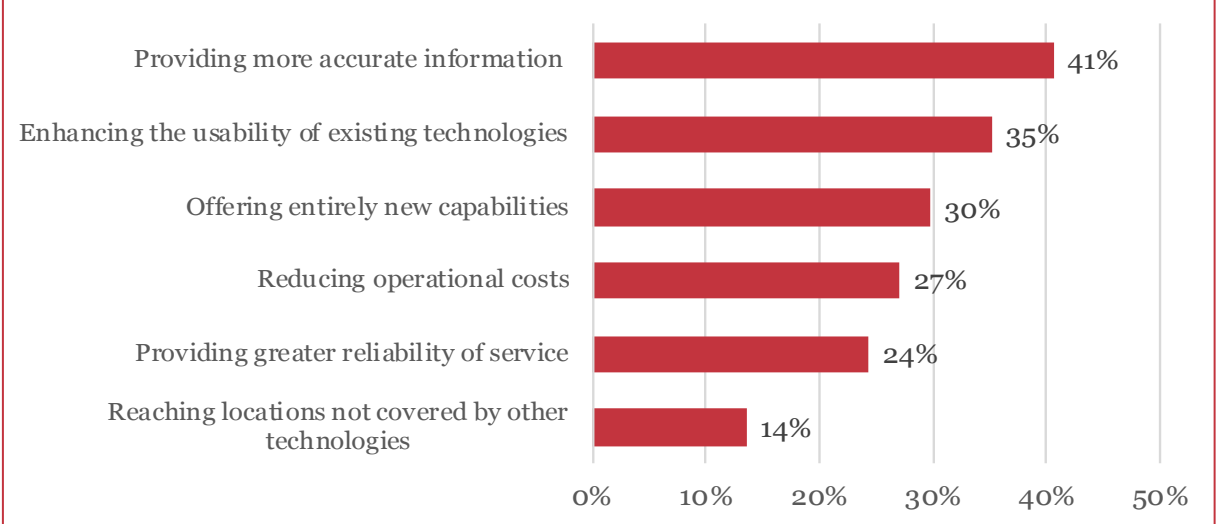

Source: Technopolis analysis of beneficiary survey. n = 30 respondents that indicated advantages of Satcom over existing technologies

Many of the respondents explained more specifically how their ARTES-developed technologies could **benefit end users in the different sectors**. Table 7 below outlines these in more detail.

Table 7 Specific examples of how the new technologies has been applied to different end users

Sector/area	Examples of benefit seen
Transport	Benefits tended to centre on producing more accurate locations, and on enabling better communication with transport operators. Examples of usage of the technologies include: <ul style="list-style-type: none"> • Producing better nautical charts • Improving the communication systems for global based operators e.g. the BBC (Airbus) • Aiding communication with air traffic control • Helping users find biking routes based on their ride preferences, drawing on open-access Earth imaging data coming from the Sentinel satellites • Introducing the use of Satellite Navigation into the rail network.
Internet, broadband access and TV	A range of different benefit types were given: <ul style="list-style-type: none"> • Enabling transatlantic data transmission via flight • Channel models, data and tools tailored for the design of High-Capacity Flexible Broadband Satellite Systems operating in Q/V and Ka bands • Creating faster and more efficient media streaming services • Creating lighter and smaller user terminals for communications • For use in ground service receivers
Disaster Relief	Benefits centre on acquiring and sharing more accurate information: <ul style="list-style-type: none"> • Using satellite data for flood prediction and storm warnings • Providing people with quicker access to information at a cheaper price • Developing back-up communication channels in the event of disasters • Helping relevant user communities in the public sector to understand the art of the possible with space technology • Enhancement of tactical satellite communications for European Defence Forces

Sector/area	Examples of benefit seen
Environmental monitoring	<p>Benefits here focused on having better quality information to enable more informed decisions on environmental management:</p> <ul style="list-style-type: none"> • Reducing space debris • Enabling marine environmental data collection • Policy Management around South East Asia providing information for partner organisation. • Producing a prototype of a device that monitors live animal traps and sending notifications to the end user when the trap is triggered • Giving people access to quicker and cheaper data • Increased efficiency with regards to decision support • Access to data and information that would not have been as easily accessed due to availability and cost. • Allowing customers to provide information more quickly, plus more flexibility in operations and the ability to control satellites in near real time
Agricultural monitoring	<p>Again, benefits centre on having better quality information to better inform farming decisions:</p> <ul style="list-style-type: none"> • Producing more environmentally friendly high protein feeds for animals in large scale farms • Farmers are using an agronomic recording app to receive data and record the actual wheat growth stage • Helping farmers generate higher yields • Opening up a new form of trading for fisheries • Accessing data and information more easily and cheaply
Urban planning	<ul style="list-style-type: none"> • Decreasing the risk of potential insurance premiums for construction and change of land use
Healthcare	<ul style="list-style-type: none"> • Remote monitoring, fall prevention, wearable devices.
Safety	<ul style="list-style-type: none"> • The technology has been applied to prevent and reduce the potential of bird strikes on civil aviation.

The case studies developed for this study also demonstrate particular examples of benefits flowing to the UK economy and society, beyond just the space sector:

- Two new chips developed by **SatixFy** with ARTES funding are capable of acquiring and tracking multiple signals, while simultaneously sending and receiving digital signals. Designed for use on antennae for satellite communications, the chips nevertheless also have potential elsewhere in minimising the size and weight, while improving the effectiveness of other connected devices (e.g. in relation to drones, defence, aeronautical communication on the move, or the internet of things). For example, Spire is currently collaborating with Singapore Technologies Electronics (STE) Limited to develop the ASICs for commercial aviation in-flight connectivity, with STE investing \$20M in the project (and SatixFy UK retaining the IP).
- ARTES funding of **Spire Global** contributed to the development of new products, including antenna and payloads for GNSS-RO signal acquisition. The satellites were ready for launch just 6-months after contract award, and within one week of deployment they were already harvesting GNSS signals to provide frequent low earth orbit weather data, demonstrating the possibilities and reliability of this source. The processed data will be made widely available and will provide scientists with temperature, pressure and humidity information that can be used in weather forecasting.
- **Remote Diagnostic Technologies** focuses on addressing the challenge of how to effectively monitor patients in remote locations and then securely transmit this real-time clinical data to the next level of healthcare. The company used ARTES funding to advance their existing technology and create a dual-use system (a single diagnostic, monitoring and telemedicine unit) that utilises

satellite communication and navigation capabilities. This has found varied applications from military medivac, civilian pre-hospital care to remote work locations such as oil platforms. The potential benefits to end-users included a reduction in costs resulting from avoided evacuations from remote sites; improved usability, allowing healthcare providers other than doctors to use the equipment; improved workforce utilisation; and enhanced capacity in remote sites via the integration and transmission of clinical data. All can dramatically improve health outcomes.

- **Inmarsat** is collaborating with a range of other UK companies through the **Iris PPP** to develop the next generation of Data Link Service to improve air traffic management. Iris will allow pilots and controllers to collaborate on flight trajectories and calculate the shortest available routes, cruise at optimum altitudes, and use continuous climb and descent paths. The system will become fully operational in 2028. As such, commercial gains for the UK companies involved are difficult to calculate at this point in time. However, there are various benefits that are expected to arise for airlines, including fuel savings and increased airspace and airport capacity (due to better route optimisation), plus incremental revenue from broadband-enabled cabins. Based on prior studies, and the share of passenger traffic of UK airlines, we estimate that the benefits of broadband-enabled ancillary revenue alone to the UK could be in the order of \$1.4million by 2035 (from broadband access, advertising, e-commerce and content streaming). Passengers and society will also benefit via reduced delays, shortened flight times and reduced CO2 emissions. The Iris solution is also expected to protect aircraft communications from cyber threats with secure gateways.

4.12 Participant overall assessment

Finally, we asked contractors to assess, overall, the costs and benefits of their involvement in the ARTES programme, from their own perspective.

The majority (80%) claimed the benefits outweighed any costs, while a further 8% reported that the benefits of involvement broadly aligned with the costs.

Only 13% of respondents (n=5) reported that the costs of involvement had outweighed the benefits they had realised.

When asked for reasons why their organisation had not been able to benefit more, there were some common threads.

Figure 12 Assessment of costs vs benefits

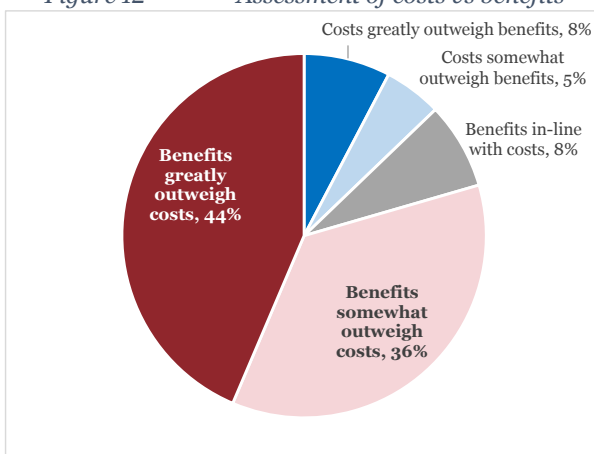

Several mentioned the length of the application and contractual process, while others pointed to administrative requirements that could be excessive compared to the value of contracts. Some also pointed to difficulties experienced in their interactions with ESA.

Our stakeholder interviews suggested that efforts have been taken to further improve and streamline various programme processes and ensure that ARTES is accessible and attractive to a wide range of beneficiaries. However, various further suggestions were also made for improvement, including streamlining of the application process, greater variability in the terms and conditions applied under different circumstances and an increase in programme transparency.

5 Value for money

This section provides a value for money analysis of UK participation in ARTES. We first discuss the direct impact of programme, based on the estimated value of commercial and non-commercial contracts emerging as a consequence of ARTES projects. Based on those estimates, we then provide an estimate of the return on investment from the programme, following HM Treasury Green Book guidelines.

5.1 Total commercial impact

5.1.1 Additional commercial and non-commercial contracts

As mentioned in the previous section, UK organisations were asked to provide their best estimates of the total value of contracts (commercial and non-commercial) that have emerged (or are expected to emerge) as a result of their participation in the ARTES programme, alongside details of the timeline for the start of this revenue and the probability that this would happen at all. Each organisation was asked to reflect on the effects generated by one specific ARTES project (i.e. one contract/participation).

As mentioned, in Section 4.9, more than half (58%) of our survey respondents reported that their organisation is already **generating new income** as a result of the developments supported through ARTES. This is despite many of these projects only concluding within the last few years. In addition, many of the other respondents (29%) are expecting to generate new income in the coming years (though with differing levels of confidence), even though they have not done so yet. Only 6 respondents (13%) within our sample reported that *no* new income was expected from their ARTES project.

Of the 26 respondents reporting that they were already generating additional revenue, around half could or would provide further details of the scale of income realised so far, or that was expected going forward (see first row of Table 8). This already provides some sense of the income generation potential of ARTES projects. For instance, the responses from these 26 organisations that are already generating income show that they have **already generated around £31M since the project finished**¹⁹. In addition, the responses from 13 of these organisations suggest that **a further £125.0M is predicted over the next five years**. This includes six companies expecting to generate £10M or more each.

In the majority of cases, the income generated so far has come from commercial sources (B2B or B2C), with only a handful of respondents suggesting some of their income has come from other sources (UKSA, ESA and the European Commission). For most, this income also tends to be split between UK and other European sources relatively evenly, with only a few pointing to non-EU income.

The twelve organisations who **may generate income in the near future** but have not yet done so were also asked about the probability, the timescale and the likely scale of income that they might see (second row of Table 8). Their responses suggest **another £8.3M in terms of expected income** (this is £16.5M in projected future income, but with a probability of 50% applied).

Overall, this equates to a **total of £156.1M in additional income** (generated or expected, beyond the value of the contract itself) across our sample. Based on comparisons with the total value of contracts (of companies providing information on income) we estimate that **each £1 of contracts leads to £14.4 in additional income**. Our case studies provide further evidence of new contracts or revenue (see Section 4.9 and Appendix C).

According to the UKSA, from 2008 the UK has made contributions of around £765M to the ARTES programme. Given the results from our survey, we estimate that **the UK's investment through ARTES has led to £11.0 billion in additional income** (£14.4 x £765M), above and beyond the value of UK contracts awarded through the programme. In this calculation we have used the *total* value of UK contributions, which includes both the value of the contracts and ESA's costs associated with running the tendering processes and providing project oversight and support. Our evidence suggests that the added value provided by ESA is a key factor in the success of the projects, not only because of the scale of projects that are made possible through the agency, but also because of the expertise provided by ESA teams and the reputational effects of taking part in ESA projects.

¹⁹ We have used the mid-point where a band was given. On average, projects have ended 2.65 years ago.

Table 8 Additional income generated (based on survey responses)

Type	Freq.	Total value of ARTES contracts ^a	Total income (so far)	Total expected income (next 5 years)	Additional income per £1 of contract
Companies <u>already generating</u> additional income	58%	£6.1M	£31.1M	£116.7M	£24.2
Companies <u>expecting to generate</u> additional income (within the next 5 years)	29%	£5.9M	£0	£8.3M ^b	£1.4
Companies that <u>do not expect</u> to generate additional income	13%	£0.2M	£0	£0	£0
Total	100%	£12.2M	£31.1M	£125.0M	£14.4^c
Responses (survey)	N=45	N=28	N=32	N=32	N=28

Notes. a. Total value of contracts for those that provided information on additional income (when relevant). The value excludes co-funding. b. Accounts for the probability of generating income, which on average is 50% (£8.3M=£16.5M*50%). c. Weighted average. Calculations include the value of income generated so far and the expected income in the next 5 years.

5.1.2 Additional employment

In terms of additional employment, we followed a similar approach, asking companies to estimate the number of jobs created and safeguarded due to ARTES contracts and any additional income generated.

Companies that were already generating additional income estimated a total of **118 jobs created and safeguarded**. This overall figure excludes information on a company that reported a total of 95 jobs created and safeguarded, as we take this to be an outlier. Consequently, our estimates are conservative.

Furthermore, companies who may generate income in the near future provided estimates of **an additional 17 jobs created and safeguarded**.

When compared with the total value of contracts (of those companies that provided information on jobs) we estimate that **each £1M in contract value leads to 15.2 jobs** (see Table 9).

Table 9 Jobs created and safeguarded (based on survey responses)

Type	Freq.	Total value of ARTES contracts ^a	Total jobs, created & safeguarded from funding	Jobs, created & safeguarded from funding per £1M contract
Companies already generating additional income	58%	£4.8M	118 ^b	24.5
Companies expecting to generate additional income (within the next 5 years)	29%	£5.0M	17	3.4
Companies that do not expect to generate additional income	13%	£0.2M	0	0
Total	100%	£10.0M	135	15.2^c
Responses (survey)	N=45	N=24	N=24	N=24

Notes. a. Total value of contracts for those that provided information on additional income (when relevant). B. Excludes one outlier that reported 95 jobs created & safeguarded. c. Weighted average.

5.2 Return on investment

The analysis of value for money (return on investment) presented below follows the HM Treasury Green Book guidance (2018). This recommends monetising all costs and benefits emerging from an intervention when possible. The calculations are summarised in Table 10 and explained further below.

Costs - According to Green Book guidance, the focus should be on additional opportunity costs incurred by the private and public sector as a result of the programme. In the case of ARTES this includes:

- The subscriptions paid by the UK to ESA, which covers the value of the contracts plus the costs associated with running the tendering processes and providing project oversight and support. As mentioned above, from 2008 the UK has contributed around £765M to the ARTES programme.
- The co-funding by UK companies to projects, based on the rules that apply to different ARTES elements (requiring between 25% and 50% co-funding), plus any other investments by companies. Surveyed companies were asked to provide information on co-funding contributions made by their organisation (including investments emerging from their own resources and from other public or private institutions). Based on those figures²⁰ we estimate that companies have contributed 85% of the value of the contracts (i.e. a 46% co-funding contribution)²¹ - all of which came from these organisations' own resources, except in one case where funding was provided by a private UK-based organisation. We have used this parameter (85%) to approximate the value of co-funding.

Benefits - Under the guidelines of the HMT Green Book, only increases in the overall capacity of the economy – i.e. productivity gains or increases in the supply of labour - should be treated as a net economic benefit. The focus of the cost-benefit analysis should therefore be understanding the direct and indirect effects of the programme in improving the productivity of firms and/or workers (i.e. the level of economic output (GVA) that firms and workers can produce with a given set of resources). These effects could arise because organisations can obtain higher prices because of benefits to consumers (e.g. due to a new or improved product or service) or because they can reduce their costs, and could be experienced in the form of greater profits for shareholders or through higher wages for workers.

This Green Book advice is now more stringent than it used to be, when net additional income as well as the knock-on effects on the economy (via multipliers) could be used as the basis for the value for money analysis. We understand that this new advice emerges from the recognition that taking into account those parameters underestimates the displacement effect that could emerge within the sectors involved in the programme, as well as between other sectors²². We have also applied an average profit margin of 12.2% to estimate the additional profit emerging from the additional income estimated. This is based on information on the UK economy, for private non-financial corporations for the period 2009-2010²³.

Counterfactual: The costs and benefits of the programmes should be compared to those that would have resulted from the alternative scenario in which the public sector did not intervene.

To our survey, 34 organisations (77%) reported that their organisations would not have gone ahead with the project in the absence of the ARTES funding, while 7 companies (16%) stated that they would have gone ahead with a longer timeframe or reduced scope, which we expect would have decreased the commercial benefits of the projects. Finally, only 3 companies (6%) stated that they would have proceeded with the project, making use of alternative private or public funding. We have assumed that the commercial benefits for this last group of companies would have materialised anyway and have therefore excluded their results from the value for money assessment.

Based on that we estimate that each £1 in value of contracts leads to £12.9 in net additional income, and £1.6 in net additional profit.

²⁰ These estimations exclude two outliers that report 14 and 64 times of co-funding.

²¹ i.e. if companies invest 85% of the value of the programme investment, then they contribute 46% of the total (company plus programme) investment

²² According to the new guidance, supply chain or induced multiplier effects should be ignored. These effects arise from the demand side (i.e. increased consumer or supply chain spending) and will place pressure on wages and other prices, causing other individuals or firms to reduce their consumption. As such, at the national level, there are unlikely to be any long run effects, and there is no reliable way of establishing effects of this type.

²³ We have also collected information on profit margins for UK companies that took part in ARTES, as recorded in Companies House (and accessible to the study team via the proprietary database FAME). Unfortunately, only 9 companies made their information publicly available. Their profit margins diverge substantially but are on average 10% (for the period 2009-2010).

The table below shows our overall calculations.

We estimate that the return on investment from the UK participation is 7.5 based on net income. This means that **each £1 invested by the UK (by both UKSA and UK contractors) leads to £7.70 in net benefit, in terms of net income** (i.e. beyond the value of the contracts themselves).

The results are lower when one applies the more stringent rules set out in the Green Book, whereby we find that **each £1 invested by the UK (UKSA and contractors) leads to £0.9 in net benefit, in terms of additional profit**.

These are conservative estimates, as they do not include the additional social benefits that may arise from, for instance, space-based applications being made available in a wide variety of industries, from agriculture to health, which have not been quantified in the context of this study.

Table 10 Value for money assessment

Cost	Key parameters/ assumptions	Value
Subscriptions	Covering the period 2008-2018	£765M
<i>Inc. value of contracts</i>	<i>Taking into account average ESA overhead (15%)</i>	<i>£650M</i>
<i>Inc. overhead</i>	<i>15% ESA overhead (UKSA estimate)</i>	<i>£115M</i>
Companies investments	85% investment by companies (% of value of contracts)	£553M
Total investment [A]	Subscriptions plus companies investments	£1,318M
Benefits		
Additional net income [B]	Additional <u>net</u> income (per £ subscription): 12.9	£9,853M
Additional net profit [C]	Additional <u>net</u> profit (per £ subscription): 1.6	£1,202M
Value for Money		
VfM 1 [B]/[A]	Based on net income	7.5
VfM 2 [C]/[A]	Based on net profit	0.9

Appendix A Methodological annex

A.1 Aim and scope of the evaluation

The evaluation was asked to assess the extent of (positive) difference that UK ARTES funding has made within the UK, and the extent to which these benefits justify the costs and effort involved. There were therefore two main elements required: (i) **an impact evaluation** - What difference did the funding make?; and **a value for money assessment** – How do the costs and benefits compare?

The study was asked to identify and explore the full breadth of benefits and impacts from ARTES funding, but with particular focus on (quantifying the) economic impact. This was to be based on a project-level assessment, although with the intention of then using this evidence to provide an aggregated, programme-level view of the benefits and impacts of the UK's investment.

The focus is **projects funded since 2008**, and in particular those that have already concluded. However, certain newer or long-running activities (e.g. the IRIS PPP) were also included on a selective basis. Related to this, the evaluation was to include a series of detailed case studies to provide a richer narrative that would help further demonstrate and exemplify the impacts (and impact pathways) by following individual examples / developments from across different parts of the programme. The cases include PPPs as well as in-depth looks at particular projects and companies.

A wide range of potential **benefits and impacts** have considered and explored. This includes (amongst others) the influence of funding on technology development (TRL levels), skill development, innovation and product development, reputation, collaboration, jobs (created or safeguarded), competitiveness, and additional sales revenue/profitability amongst the beneficiaries. Similarly, the study considered the wider impacts of UK investment in ARTES, including spillovers beyond the funded projects and organisations. The study also considered the wider impacts of investment, for instance in increasing the role the UK is able to play in directing space priorities and investments.

The assessment includes both current and **likely future benefits** and impacts (particularly economic) of ARTES funding and is both qualitative and quantitative, but with key measures (indicators) quantified

A.2 Programme logic / theory of change

The evaluation was guided by a theory of change (ToC) that draws connections between the investments made by the UK government and UK-based industrial partners (inputs), the activities and support unlocked thanks to those investments and the immediate outputs that they generated. The theory of change also describes how those outputs could then materialise into short- and long-term outcomes (among UK-based industrial partners), and further impact to industry and the UK economy.

The ARTES projects in scope are from different elements, which have different objectives and support different TRLs. However, the evaluation needed to arrive to a final aggregated view of programme results overall. As such, we developed a programme-level logic model and ToC that incorporates the rationale for UK investment and that identifies outputs and outcomes that are reasonable to expect from the different elements and from a technology programme of this nature, and where the potential outcomes of each project could be classified within these broader 'outcome/ impact' categories.

The ToC provided the basis for our evaluation framework, which is also grounded in the research policy literature and the methodological guidelines on impact assessment that we prepared for ESA in 2012 and on our evaluations of the ARTES programme and of the ARTES PPP projects, also for ESA.

We start our description of the theory of change by identifying the **objectives** of the ARTES programme and the objectives that the UK government seeks to achieve by taking part in this optional programme. The ARTES programme aims to:

- Enable industry to explore – through R&D activities – innovative concepts to produce leading-edge satcom products & services

- Capitalise on and transform these into operational products and services that are commercialised, profitable and self-sustaining
- Maintain, develop & secure the future of industry in a global competitive market
- Develop satellite-based solutions that meet the needs of institutions & society

Additionally, the UK government utilises ARTES as a tool to:

- Develop UK space technology and capabilities
- Make the UK the best place to start and grow a space business
- Grow the size and value of the UK space sector (with the ambition of growing of the UK share of the global space market from 6.5 per cent to 10 per cent by 2030)

The **case for government intervention** is grounded in standard market failure arguments, as space technologies are often high risk and there is a long lead time between initial R&D and wealth creation, which creates sub-optimal levels of investment.

In terms of **inputs**, the UK contributes a total ~£70M a year to ARTES (based on UKSA estimate of £765M in subscriptions, 2008-18). Approximately 85% of this goes to funded projects, while the remaining 15% is dedicated to fund ESA's management and support to the programme (overhead). Projects are co-funded by industrial partners that provide cash and in-kind contributions. Each element has different funding rules as described in Appendix B.7.

ARTES is led by the Telecommunications and Integrated Applications (TIA) directorate at ESA. The TIA directorate is responsible for co-ordinating, shaping and supporting innovation in satellite telecommunications and for the promotion of applications that involve the combined use of space-based telecommunications, earth observation and navigation systems. As described in Section 0, support from ESA includes technical expertise and access to dedicated assets such as satellite capacity, satellite systems and emulators / simulators, as well as dedicated equipment (such as modulators, demodulators and modems of DVB-S2/S2X, a digital satellite television broadcast standard).

The programme funding supports a wide range of **activities**, including strategic analysis, market research, feasibility studies, impact assessment, research and technological development, piloting, demonstration, validation and deployment. Industry is responsible for bringing the end result to market, while retaining the IPR. In addition, the funding also goes to support dissemination activities organised by ESA to support intelligence and information flow the European satellite industry regarding new developments and market trends.

In terms of **immediate outputs**, it is expected that some projects will lead to an increase in TRL as ideas and concepts explored, and new/improved technologies and products and systems are developed. This could in turn lead to projects being de-risked for further investment (**short term outcome**) and, eventually, lead to products and services being commercialised and additional grants / sales revenue generated (**long-term outcome**). This could also lead to UK industry expanding its institutional and commercial space market.

Since the ARTES supports projects across various TRLs, it is expected that further investments will be needed to achieve those short and long-term outcomes, at least in the case of core competitiveness projects and business applications. The ARTES PPPs, on the other hand, are designed to bring innovative products and systems into the marketplace immediately after the end of the mission, or at least in a relatively short time after the mission is completed, as such it is reasonable to expect that those outcomes (commercialisation and additional income) will materialise in the short term.

ARTES projects could also lead to new / improved internal knowledge, skills, capabilities, as well as to codified knowledge (e.g. publications & patents) and other knowledge transfer and dissemination activities.

Participation in the ARTES programme could also lead to new or strengthened UK partnerships, collaborations and relationships that continue beyond the project. Even though the programme

includes well established space companies such as Airbus, Thales and Inmarsat, it also encourages the participation of companies that are relatively new to the space sector but that have technologies and products of relevance for the SATCOM market. This could lead to the spin-in of organisations that remain active in the space sector even after the end of the project, and lead to UK industry entering institutional and commercial space market.

There is also an issue of the economic leverage produced by the reputational effect of developing a technology or service under ARTES/ESA support. Our prior work evaluating ARTES and other ESA programmes show that this is due to two factors. First, any product or service developed under an ARTES contract would have had to meet ESA’s technical and quality standards, which is deemed by the industry as synonymous of reliability. Second, some contracts offer the opportunity for first flights/ heritage, and de-risks the technology. Participation in ARTES could also increase the attractiveness of UK organisations as R&D partners.

Overall, all those different **impact pathways** could lead to an increase in competitiveness of UK organisations, as well as growth in UK space technology sector. As such, there is some expectation that there would be positive spillover effects to other industrial actors (not involved in the programme). This could materialise through, for instance, the development of new integrated applications that are made possible due to the developments of infrastructure or ground systems supported by the programme.

Finally, there are also spillover effects that could emerge from support to industries that use space-enabled technologies and consequent wider economic and social benefits to UK economy and society, such as the narrowing of the digital divide through access to space-based broadband in remote areas where other (terrestrial) solutions are not viable; the increase in competitiveness of maritime sector due to access to two-way communications that improves communication with and between ships and or improved air traffic management. Some of those positive spillovers will materialise, however, outside of the UK.

These dynamics are presented in a schematic way in Figure 2 of the main report, while Table 11, Table 12 and Table 13 below show the indicators that were then used to quantify these different inputs, outputs, outcomes and impacts. The tables also show the sources of information used to produce those estimates. The subsequent section provides details of the methodology we then followed.

Table 11 Indicators of programme inputs and activities

Category	Indicator	Source
UK contribution	Value of UK contribution 2008-2018	UKSA
Co-funding	Value of the co-funding contribution	Survey
Additional costs	Value of additional costs to Industry	Survey

Table 12 Indicators of programme outputs

Category	Indicator	Source
Raised TRL	<ul style="list-style-type: none"> • % of projects that raised TRL levels, at the end of the projects • % of projects that moved from TRL 1-4 to TRL 5+ 	Survey
New / improved internal knowledge, skills, capabilities	<ul style="list-style-type: none"> • % of respondents that agree that participation in ARTES has led to improved internal knowledge, skills and capabilities • Examples or testimonials of new / improved internal 	Survey Interviews Case studies
Codified knowledge (e.g. publications & patents) and other knowledge transfer and dissemination activities	<ul style="list-style-type: none"> • Number of publications (in refereed journals and books emerging, and others) emerging from ARTES projects • Number of publications patent applications emerging from ARTES projects • Number of licenses emerging from ARTES projects • Number of technology or concept demonstrations emerging from ARTES projects • Number of new or improved technologies, products or systems emerging from ARTES projects • Number of new spin-outs emerging from ARTES projects 	Survey

Category	Indicator	Source
New / strengthened <u>partnerships</u> , collaborations and relationships established	<ul style="list-style-type: none"> • Number and % of projects that included new partners • % respondents that agree that participation in ARTES has led to strengthened relationships with partner organisations in the project • Examples or testimonials of strengthened relationships 	Survey Interviews Case studies
<u>Spin-in</u> of organisations to space sector through project involvement	<ul style="list-style-type: none"> • Number and % of companies new to the space sector before participation in ARTES 	Survey

Table 13 Indicators of programme outcomes and impacts

Category	Indicator	Source
Projects <u>de-risked</u> for further investment	<ul style="list-style-type: none"> • % of respondents that agree that participation in ARTES has led reduction in the cost of their project idea / technology • % of respondents that agree that participation in ARTES has led reduction in time to market for their project idea or technology • % of respondents that agree that participation in ARTES has led the de-risking of project for further investment 	Survey
Increased <u>visibility</u> and <u>reputation</u> of UK capabilities among potential partners, funders and clients	<ul style="list-style-type: none"> • % of respondents that agree that participation in ARTES has led to improved attractiveness of organisation as an R&D partner in the space sector • % of respondents that agree that participation in ARTES has led to improved reputation or awareness of organisation in the space sector • % of respondents that agree that participation in ARTES has led to improved visibility and awareness of your project idea or technology 	
Increased <u>attractiveness</u> of UK organisations as R&D partners	<ul style="list-style-type: none"> • % of respondents that agree that participation in ARTES has led to improved attractiveness of their organisation as an R&D partner in the space sector 	Survey
New UK partnerships, collaborations and relationships that continue beyond the project	<ul style="list-style-type: none"> • % and number of new partners with whom there is continuous working relationship after the end of the project 	Survey
Continued activities in space sector of spin-ins	<ul style="list-style-type: none"> • % of spin in companies that actively work in the space sector as a consequence of participation in the ARTES programme • Examples or testimonials from spin-in companies 	Survey Interviews
UK industry enters institutional and commercial space market and / or expands market share	<ul style="list-style-type: none"> • % of respondents that agree that participation in ARTES has led increased attractiveness of their organisation to institutional and commercial funders in the space sector • % of respondents that agree that participation in ARTES has led to an increase in likelihood that you can expand your presence in space markets • % of respondents that agree that participation in ARTES has led to an increase market share in upstream space markets • % of respondents that agree that participation in ARTES has led to an increase market share in downstream space markets • Examples or testimonials of expansion into institutional and commercial markets 	Survey Interviews Case studies
Products / services / systems commercialised	<ul style="list-style-type: none"> • Number of Products / services / systems commercialised • Examples or testimonials of products / services / systems commercialised 	Survey Interviews Case studies
Increased income to UK space sector from additional grants / sales revenue	<ul style="list-style-type: none"> • % of respondents that agree that participation in ARTES has led to an increase in likelihood of securing future contracts in the space sector • % of respondents that agree that participation in ARTES has led new income streams • Value of additional sales revenue generated thanks to the participation in the ARTES programme 	Survey Economic modelling
Improved competitiveness of UK organisations	<ul style="list-style-type: none"> • % of respondents that agree that participation in ARTES has led to an increase in productivity • Value of productivity increase (GVA per worker) due to participation in ARTES • % of respondents that agree that participation in ARTES has led to improved competitiveness (nationally and internationally) 	Survey Economic modelling

A.3 Overview of approach and methods

We employed a mixed method approach, organised around three main work packages:

- **WP1: Scoping** – A short inception period, to review available programme documentation and data, develop the programme logic model and evaluation framework, and finalise the evaluation approach
- **WP2: Primary data collection** – The main phase of evidence gathering, including telephone surveys of contractors and stakeholder interviews, as well as the development of illustrative case studies
- **WP3: Analysis and reporting** – A final phase, drawing together and analysing the various available information and evidence gathered through the study to address key requirements and questions.

Programme documentation and data available to the study team was limited, and so the approach relied heavily on a series of primary data collection activities. This included: a telephone-based survey of project leads (45 individuals from 40 organisations); interviews with 10 members of the team at UKSA and wider stakeholders; and interviews with 10 individuals to develop a series of 7 in-depth case studies. We explain each of the main methods in more detail below.

A.3.1. Desk research / portfolio analysis

UKSA provided the study team with details of UK involvement in contracts funded through the Core Competitiveness programme (including Competitiveness & Growth and Advanced Technology elements) and through the Integrated Applications Promotion (IAP) programme, for the period 2009 to August 2018. This included details of the contracts (title, value) and the organisations involved. The study team also extracted similar information (though not contract values) from the online ARTES projects database²⁴, covering the Future Preparations element, as well as selected PPPs (IRIS, LPM and SAT-AIS). Similar information for the other ARTES elements was not available.

The results of our analysis of available data, alongside a review of publicly available documentation on the ARTES programme (and the UK's involvement) are presented in this report (in sections 2 and 3, as well as in the programme logic set out above). Further desk research was undertaken specifically in relation to the case studies developed (see below).

A.3.2. Survey of contractors

A contractor survey was undertaken to collect information on UK-based participants in ARTES projects. The exercise included UK-based organisations that had participated, either as a prime or a sub-contractor, in projects within the past decade. We focused on completed projects only, and so the number of contracts quoted below is sometimes lower than is presented in the portfolio analysis.

Contact information

The approach was based on project-specific interviews and so required details of specific UK contact points (name, email address and phone number) associated with individual ARTES contracts. We were able to identify just over 100 such contacts, as follows:

- The UKSA database of completed **Core Competitiveness projects** with UK involvement, included 84 unique contracts, involving 115 UK participations (with 86 instances of a UK prime and 29 of a UK partner). There were 37 unique companies listed (based on organisation name). Contact names and email addresses were provided against half of the participations. The study team were able to then identify a relevant phone number to use in most of these cases. There were 33 unique contacts in total, covering 17 organisations, and associated with 47 participations in 43 contracts.
- For **ARTES IAP projects** with UK involvement, the main database provided by UKSA (and used for the portfolio analysis) did not contain contact information. A separate dataset of contacts was therefore provided, which covered around 40% of these IAP projects. There were 45 unique contacts in total, covering 43 organisations, and associated with 54 participations in 53 completed contracts. A contact name and /or email address was provided and the study team identified phone numbers.

²⁴ <https://artes.esa.int/projects>

- The study team also extracted online information on the 71 completed contracts with UK involvement within the **Future Preparations, IRIS, LPM and SAT-AIS** elements – including details of named contacts where these were available (i.e. where the UK was the prime contractor). Across these elements there were 41 unique organisations participating 101 times (38 as prime, 63 as a partner). We identified 29 unique contacts in total, associated with 38 participations.

There was very little duplication of identified contacts within the different parts of the ARTES programme. Only one individual is named for contracts in more than one element.

The following table summarises the coverage of contacts across the seven elements of the programme for which we had data. The table also shows, for comparison, the total number of UK contracts and participations as a whole, based on the portfolio analysis in the main report.

Table 14 Overview of contact details available for the survey of UK contractors

Element	Source	UK Contracts	UK Participations	Named contacts
FP	ESA ARTES online database	65	95	23
C&G	UKSA Database	133	158	31
AT	UKSA Database	26	34	3
IAP	UKSA additional data	134	240	44
IRIS	ESA ARTES online database	10	22	3
LPM	ESA ARTES online database	5	6	2
SAT-AIS	ESA ARTES online database	2	3	0
		375	558	107

Where we had not identified any named contacts against a participating organisation, we used the ESA p-star database to obtain a central contact point within the organisation to approach for assistance. This provided another 25 (central) contact points.

Finally, at a later stage in the study (and because of low response numbers in the core competitiveness area), UKSA provided the names and details of 9 (senior) contact points within non-responding organisations. These individuals had agreed to be approached to discuss whether relevant project contacts could be identified within their organisation.

Approach

The main list of 107 UK-based contacts were approached initially by email, with an introduction to the study and the study team, and with notification of the forthcoming request for input. Each was then approached by phone (up to five times), to request an interview relating to the ARTES project for which they had been identified. Where they were named against more than one project, they were asked to select the project they were most familiar with to speak about.

The approach taken for the 34 central contacts identified was slightly different. In these cases, we requested assistance in identifying relevant project-specific contact points within their organisation, and then followed up on these suggestions in the same way as above. This approach had some limited success and enabled us to speak with another ~15 project contacts.

For the interviews we used a Computer Assisted Telephone Interview (CATI) survey approach, as this is the most effective way to obtain quantitative and qualitative information consistently from a relatively large number of organisations. The CATI interviews followed a structured questionnaire, which was developed with the input of UKSA and sought information on most of the indicators identified in our evaluation framework above. It included mostly closed-option questions that would allow for the calculation of quantitative indicators (e.g. value of co-funding in £) and quasi-quantitative indicators (e.g. % of respondents that agree that participation in ARTES has led to the increased attractiveness of their organisation to institutional and commercial funders in the space sector). A small number of open questions were also included, to allow respondents to clarify or expand on particular points.

Response

Responses were obtained from 45 individuals, who provided information about projects from across the ARTES programme. The distribution across the programme elements is shown below.

Table 15 Overview of responses to the UK contractor survey, by programme element

Element	UK Contracts (where known)	Named contacts identified	Interviews undertaken
Future Preparations	65	23	5
Core Competitiveness	159	34	11
IAP	134	44	26
PPPs (IRIS, LPM, SAT-AIS, NeoSat)	17	5	3
	375	106	45

Overall, 40 separate organisations were consulted. This included 5 large companies, 20 SMEs, 10 micro companies and 5 universities and other public bodies (see list below). This covers 19% of the 208 organisations known to have participated in these elements of the ARTES programme over the past decade, and includes many of the most frequent participants (the other top participants have been consulted through the stakeholder interviews and in the development of case studies).

Table 16 Overview of responses to the UK contractor survey, by organisation type

Large Companies	SMEs
Airbus Defence and Space	AgSpace
Cobham Technical Services	Ampac ISP UK
Inmarsat	Avanti Communications Ltd
Global Invacom	COM DEV Europe (Honeywell Aerospace UK)
Surrey Satellite Technology Ltd.	DMCii
Micro Companies	e2E Services
Archangel Imaging	Entocycle
DryGro Ltd.	Environment Systems
Efeca	Helios
iSat	IPF (Courtyard)
Lukairos	MDA space and robotics
Riverbeck	Nottingham Scientific Ltd.
SafetyNet Technologies	Quicklink (video distribution services)
siHealth	Rezatec
Spottitt (prev. Qurus)	Sunwynd Ltd.
TeamSurv	TCarta (prev. Proteus Geo)
Universities / other	TEKEVER
Manchester Metropolitan	Telespazio Vega
NPL	Thales Alenia Space
RAL Space	VTOL Technologies
University of Strathclyde	
University of Surrey	

A.3.3. Interviews

A series of 10 semi-structured interviews were undertaken with programme management (UKSA/ESA) personnel and other key stakeholders. A list of those consulted is shown below.

Table 17 Programme management / stakeholder interviewees

Name	Role	Organisation
Ian Downey	UK Ambassador Platform Network Coordinator	ESA
Catherine Mealing-Jones	Director Growth	UKSA
Emily Gravestock	Head of Application Strategy	UKSA
Tim Just	Head of Space	Innovate UK
Craig Brown	Lead Space Technologist	Innovate UK
Peter Aspden	Chair	TechUK
Ben Stocker	Project Engineering and Telecomms Director	SSTL Ltd
Stuart Martin	CEO	Satellite Applications Catapult
Bert Meijvogel	Senior Advisor, Technology Transfer & Telecomms	Netherlands Space Office
Aleix Megias	VP Programmes	Open Cosmos

These conversation varied slightly depending on the position and expertise of the individual, but in each case looked to cover aspects relating to programme impact, value for money and delivery.

A.3.4. Case studies

The evaluation also included the development of a series of 7 detailed case studies (shown in Appendix C) that provide a richer narrative and help further demonstrate and exemplify impacts (and impact pathways) by following individual examples from across different parts of the ARTES programme.

The case studies focus on the following list of organisations and projects. In developing the cases, we drew upon primary data collection (surveys and interviews), complemented with additional desk research. A note of the individuals consulted is shown against the relevant case below.

Table 18 Programme management / stakeholder interviewees

Organisation	ARTES project(s)	Interviewee
Oxford Space Systems	<ul style="list-style-type: none"> Material Investigation of Flexible Composites (NeoSat) Deployable Filar Array Antenna (SAT-AIS) Scalable Deployable Panel Array Deployable Steerable Patch Panel Antenna Array for Microsats 	<ul style="list-style-type: none"> Mike Lawton, Founder and CEO Michael Loweth, Business Development Manager
SatixFy	<ul style="list-style-type: none"> Development of Beat RFIC / Prime ASIC chips 	<ul style="list-style-type: none"> Moche Cohen, VP of Research and Development
Spire Global	<ul style="list-style-type: none"> ARTES Pioneer programme funding 	<ul style="list-style-type: none"> Hina Khan, Project Coordinator
TCarta / Proteus Geo	<ul style="list-style-type: none"> Bathymetrics Data Portal 	<ul style="list-style-type: none"> Richard Flemmings, Operations Director
Remote Diagnostic Technologies	<ul style="list-style-type: none"> AMAZON project 	<ul style="list-style-type: none"> Leigh Cornock, Director of R&D
Rezatec	<ul style="list-style-type: none"> Peat Spotter project 	<ul style="list-style-type: none"> Tim Vallings, VP Global Resources Christina Wood (EFECA) David Smith (South West Water)
Inmarsat	<ul style="list-style-type: none"> IRIS PPP 	<ul style="list-style-type: none"> Dale Irish, Head of Aviation product management

Appendix B ARTES programme elements

B.1 Overview

Given its broad objectives, ARTES has evolved over time to meet changing needs. The various sub-elements of the programme are now grouped into three main areas of activity:

- Support for the **Core Competitiveness** of European space industry – providing a single, streamlined, yet flexible framework that allows industry to start with an idea and develop it through to the introduction of new products and services to the market. There are two main components: Advanced Technology; and Competitiveness and Growth.
- **Business Applications** – a relatively new approach in which commercial applications using any space assets are addressed by the Integrated Applications Promotion (IAP) programme. A new class of activities called Kick-start has also been introduced to attract new players
- **Public-Private Partnerships (PPPs)** – a mechanism for leveraging public funding with private investment, ensuring that risk in new ventures is allocated to those best able to handle it²⁵. ESA has developed a portfolio of ~15 ARTES PPPs, which between them involve all European satellite operators and primes. Some PPPs are ESA-initiated, while others are initiated by industry (the latter are conducted through the ARTES Partner programme).

In addition to which are the **Future Preparations** (scoping studies) and **ScyLight** (development, demonstration and utilisation of innovative optical technologies) elements.

The current **ARTES elements** (see Figure 13) form a flexible framework across the full value chain, funding activities from market research and feasibility studies, to demonstration and deployment.

Figure 13 Overview of ARTES elements

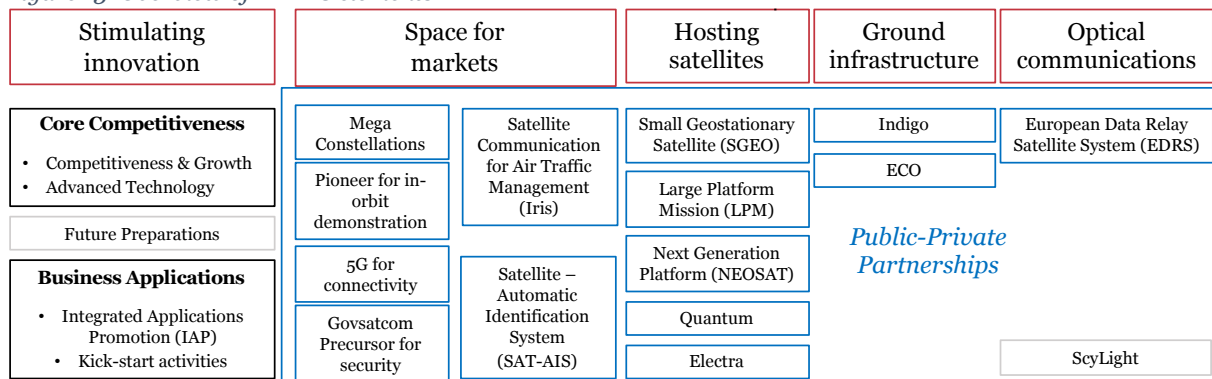

In the sub-sections below we introduce each of the main programme elements in more depth. UK effort and funding has focused particularly on three elements (competitiveness & growth, IAP and NeoSat), which collectively account for nearly two-thirds of the UK's c. £765M contributions to ARTES in the past decade.

B.2 Stimulating innovation

Future Preparations: provides horizon scanning, strategic analysis, market analysis, technology and system feasibility studies, as well as work on defining regulations and standards required by new satcom innovations. The FP unit produces an Annual Workplan that incorporates responses (from industry and research) to a Call for Ideas, setting out priority workstreams and PPP opportunities. The unit also supports the European Commission to optimise European telecommunications infrastructure and systems. Contractors are eligible for 100% funding.

²⁵ With the programme absorbing more risks associated with technology development while a lead partner manages market risks related to operation, service provision and construction with other industry partners

Core Competitiveness: a recent merger of the Competitiveness & Growth, and Advanced Technology elements to improve the flexibility of funding and support to contractors. It supports developers of satcom products, services and partnerships, at any point in the development cycle, combining the benefits of former programme elements, as detailed below. UK subscription: c. £294M 2008-18.

- **Competitiveness & Growth:** the development, qualification and demonstration of “products” (a piece of platform, payload or satellite equipment, a user terminal or full telecommunication system) and telecommunication applications, with the aim of facilitating competitiveness in the satcom industry.

The C&G element targets four development phases to support nascent technologies as well as newcomer SMEs to reach maturity, providing varying levels of funding during each phase adjusted to the risk level of innovation. The four phases are:

- Definition (max 50% funding) – support for initial design concepts
- Technology (max 75% funding) – mitigation of technical risks during prototyping and testing
- Product (max 50% funding) – preparation for commercialisation
- Demonstration (max 50% funding) – support for market entry and piloting/validation.²⁶

- **Advanced Technology:** research and development activities for long-term satcom industry requirements, focusing on satellite technologies, ground and user equipment. The element’s R&D foci are based on the Annual Workplan produced by the Future Preparations element which combines ESA and industry concerns for emerging telecommunications sector challenges and opportunities. Activities of contractors accepted to this element are 100% funded by the ESA.

Integrated Applications Promotion: supporting the development, implementation and pilot operations of Integrated Applications, through funding feasibility studies and demonstration projects that utilise data from space assets in combination with terrestrial services for new commercial and public functions. UK companies have used IAP to develop telemedicine services, advise farmers on fertilization, and target waste collection. Importantly, applications are developed in response to end-user requirements, rather than driven by a specific technology. UK subscription: c. £116M since 2008

B.3 Space for markets

Satellite Communication for Air Traffic Management (Iris): Iris fulfils the satellite component of the unified 4D air traffic management (ATM) communication system created by the Single European Sky Policy (SESP). The new system will align Europe’s 60+ individual sectors through a central data link instead of the fragmented and outdated VHF radio-based systems currently used. Iris is a collaboration between ESA and the Single European Sky ATM Research Programme (SESAR). The SESP and Iris roll-out will be incremental with finalisation expected in 2028, to allow time for many external and end-user adaptations required and alignment of standards to those set by EUROCAE.

Satellite – Automatic Identification System (SAT-AIS): AIS is a short-range tracking system used on ships to provide identification and positioning information to vessel and shore stations. SAT-AIS will provide AIS data via satellite, greatly increasing the range of AIS services to potentially anywhere on Earth. The ESA SAT-AIS element is conducted in partnership with the European Maritime Safety Agency (EMSA) aiming to enhance the capabilities of European shipping industries. SAT-AIS will be delivered through three phases: technology predevelopment activities; implementation and validation of a Data Processing Centre; and system integration and commercialisation of services leveraging PPPs.

Other recently announced market-related initiatives include:

- **Govsatcom Precursor:** a programme aligned with the EDA Govsatcom demonstrations, to demonstrate the benefits of pooling and sharing governmental and commercial satellite services for the provision of secure and guaranteed 5G governmental applications for purposes such as security, crisis management and infrastructure monitoring. This preparatory programme brings together so-

²⁶ <https://artes.esa.int/news/evolution-artes-3-4-and-5>

called 'paxis', i.e. partnerships between European governmental satcom operators, to demonstrate the system benefits of pooling satcom resources. The first iteration of paxis developed secure mission control systems and operations centres, including capabilities for Remotely Piloted Aircraft Systems (RPAS). Five more paxis have been identified to form a federation representing most European satellite operators and service providers, to run demonstration projects from 2017-2020. A final phase will test and demonstrate the value of pooled resources for pan-European 5G coverage.

- **Mega Constellations:** 'mega constellations' of hundreds, even thousands of satellites will be necessary to transmit the large amounts of data required by emerging disruptive innovations such as the Internet of Things. ESA is funding and supporting mega constellation contractors throughout the entire value chain and development process in order to ensure Europe and Canada remain competitive amongst the multiple mega constellation initiatives announced globally. Calls for Proposals to this element closed in June 2018.
- **Satellite for 5G:** aligning with and building upon the efforts of the European Commission on 5G and other national and international initiatives, ESA is forming PPPs with the European space industry to: trial 5G services in vertical market sectors such as transport, public safety, media and entertainment; coordinating cross-cutting activities for applications development, standardisation, resource management, interoperability demonstrations, supporting technologies, and outreach technologies. This element was committed to by ESA and 16 satellite industry leaders in 2017.
- **Pioneer in-orbit demonstration:** addresses a gap in the market for in-orbit demonstration services that are otherwise expensive and time-consuming to arrange via conventional market opportunities. Pioneer is a 'one-stop shop' for the industry to access timely, cost-effective validation services. The Pioneer programme currently has four validation 'Space Mission Provider' (SMP) PPPs – Open Cosmos (UK), Sitael (Italy), Airbus (France) and Spire Global (UK),

B.4 Hosting satellites

Small Geostationary Satellite (SGEO): a telecommunications satellite platform capable of accommodating a wide range of commercial payloads and missions, from TV broadcasting to multimedia applications and Internet access. This element is a PPP in which ESA focuses its support on R&D, while the industrial partner team (consisting of OHB System AG and subsidiaries LuxSpace and OHB Sweden) focus on development phases and commercialisation. SGEO was launched in 2017 and provides satellite services to Spain, Portugal, the Canary Islands and South America.

Large Platform Mission (LPM): the development and deployment of the Alphasat platform and the first satellite to use it (Alphasat), launched 2013. It is a public private partnership operated by UK based Inmarsat and built by EADS-Astrium. Alphasat incorporates innovative on-board processing technology and promotes novel user services, providing data services to users across Europe, Asia, Africa and the Middle East. Alphasat is the largest public-private space product ever produced in Europe and at the time of launch was the most sophisticated communications satellite ever built.

Next Generation Platform (NEOSAT): Specifically aimed at developing and demonstrating in-orbit, two new satellite platform product lines, Eurostar Neo and Spacebus Neo, to grow European capability in 3-6 tonne geostationary satellites. The core aim of NEOSAT is to reduce the cost of in-orbit data capacity, by electrifying craft propulsion, increasing payload, and reducing manufacturing costs through modular design and supply chain integration. Neosat is jointly managed by ESA and CNES, in partnership with industry. UK subscription: c. £67M since 2008

Quantum: a programme to design telecommunication satellites that can be reprogrammed whilst in orbit to adopt new operations and even change orbital position to respond to geographical or performance demand. The satellite payload is optimised by its software which predicts, operates and manages the on-board configuration to achieve responsive adaptation and efficiencies. This new design of satellite will have impacts across the value chain, affecting how telecommunication satellites are procured and manufactured in Europe as design moves from custom/one-off to more generic and modular construction. Quantum is implemented by a PPP between ESA and Eutelsat (France), developed by a core team managed by Eutelsat consisting of Airbus (UK) as satellite and payload prime,

SSTL (UK) for provision of the platform, Airbus (Spain), Space Engineering (Italy), Norspace (Norway), and Airbus (Netherlands) providing various subsystems.

Electra²⁷: support to European industry to develop, launch and validate in-orbit an electric propulsion telecommunications satellite in the 3-tonne launch mass range. Electric propulsion can achieve up to 90% cost savings compared to chemical propulsion. Electra was established to coordinate the development and demonstration of the new platform and associated technologies in order to gain market acceptance and deliver fuel efficiencies for the benefit European industries and end-users.

B.5 Ground infrastructure

Indigo: the development of ground segment technologies necessary to capture the benefits of next generation high-throughput telecommunication satellites. Indigo is a PPP between ESA and Intelsat (Luxembourg) and Newtec (Belgium) to enhance Newtec's Dialog platform, which will in turn increase throughput and the capability to deliver new services and expand opportunities into new markets for platform users.

ECO (Every Child Online): developing and introducing ground technologies and services in Africa to leverage the greater capabilities of Avanti's Hylas 4 telecommunication satellite. A PPP between ESA, Avanti (UK), Newtec (Belgium) and SatADSL (Belgium) – ECO will run from 2016 to 2021, testing a range of services across 1400 sites in 6 African countries in a range of rural and urban sectors. This programme aims to ensure European telecommunication service providers remain competitive in Africa as the region develops, by developing the ground infrastructure required to provide high-quality competitive telecommunication services to the region.

B.6 Optical communications

European Data Relay Satellite System (EDRS): development and implementation of the EDRS system. EDRS consists of a ground control system, transmission infrastructure and geostationary satellites to relay information to / from non-geostationary satellites, spacecraft, other vehicles and fixed Earth stations, allowing them to permanently transmit and receive data. EDRS strengthens Europe's telecommunication infrastructure to meet the requirements of increasingly data intensive public and commercial uses, which are otherwise compromised by delays in data transfer and reliance on non-European space assets, thus affecting EU strategic independence.

ScyLight (Secure and Laser Communication Technology): This element complements the existing EDRS and EDRS Global (formerly GlobNet), enabling ESA to have optical communication technologies implemented as a standalone programme. Optical Communication Technologies (OCT) present a major opportunity and disruption for current satellite communications, achieving a new generation of transmission rates, data security and resilience. Demonstration of this opportunity, however, is currently limited and European and Canadian industry capacity in this field is underdeveloped. Through the ScyLight element, ESA is seeking to develop, demonstrate and utilise innovative optical technologies for satellite communication (as well as new market opportunities), and to support industry to develop or seize related market opportunities.²⁸ ESA is also conducting system and market studies on behalf of industry partners in order to better understand the needs of users and coordinate the European research and development effort.

The programme offers varying support to projects with different levels of operational / commercial maturity (e.g. providing more support for riskier/more innovative projects, while industry co-invests more when closer to market). The following tables summarise some of the key features and scope of the different programme elements.

²⁷ https://www.esa.int/Our_Activities/Telecommunications_Integrated_Applications/Electra

²⁸ <https://artes.esa.int/scylight/overview>

B.7 Summary of key features

Table 19 Key features of ARTES elements

Element / PPP	Key Features
Future Preparations	<ul style="list-style-type: none"> • Focus: Horizon scanning, preliminary studies and investigations, emerging sector challenges/opportunities, regulations and standards. Defining Annual Workplan. • Funding: 100% (through the Advanced Technologies element) • TRL: 1 – 3 • Eligibility: Open to all member states and industries, no authorisation by national delegation required.
Core Competitiveness: Competitiveness & Growth	<ul style="list-style-type: none"> • Focus: development, qualification and demonstration of products and telecommunications applications that serve to enhance competitive trajectory of European and Canadian sat-com industry as a whole • Funding: <ul style="list-style-type: none"> – 1) Definition phase (max 50% funding); – 2) Technology development phase (max 75% funding); – 3) Product phase (max 50% funding); – 4) Demonstration phase (max 50% funding) – SMEs: 75% (max €250,000) of costs for all development phases • TRL 1 – 9 • Eligibility: Open to all member states and industries. Authorisation by national delegation required.
Core Competitiveness: Advanced Technology	<ul style="list-style-type: none"> • Focus: R&D of new technologies for telecommunication satellites, ground and user equipment as prioritised by the Future Preparations Annual Workplan • Funding: 100% • Eligibility: only industries from member states participating in this element, must have authorisation from national delegation.
Integrated Applications Promotion	<ul style="list-style-type: none"> • Focus: feasibility studies and demonstration projects that utilise satellite data in combination with terrestrial services • Funding: <ul style="list-style-type: none"> – Zero-equity €60k - €2M+ – Feasibility study: up to 100% – Demonstration project: up to 50% – Kickstart activity: up to 75% (max €60k/6 months) • TRL 6 – 9 ('user-driven applications leading to pre-operational services') • Eligibility: Open to all subscribed member state industries / organisations
Next Generation Platform (NEOSAT)	<ul style="list-style-type: none"> • Focus: develop and qualify the Eurostar Neo and Spacebus Neo, to enable European capacity in 3-6 ton launch mass range. • Prime contractors: <ul style="list-style-type: none"> – Eurostar Neo: Airbus Defence and Space (Airbus DS) (France) – Spacebus Neo: Thales Alenia Space (France)
Large Platform Mission (LPM)	<ul style="list-style-type: none"> • Focus: development and deployment of the Alphabus platform and Alphasat • Prime contractors: <ul style="list-style-type: none"> – Operator: Inmarsat (UK) – Construction: EADS-Astrium
European Data Relay Satellite System (EDRS)	<ul style="list-style-type: none"> • Focus: development and implementation of EDRS satellite and data control infrastructure • Prime contractor: Airbus Defence and Space (Germany) • Contractors: <ul style="list-style-type: none"> – Eutelsat (France) – OHB (Denmark) – Avanti Communications (UK) – TESAT Spacecom GmbH / German Aerospace Centre (Germany)
Satellite Communication for Air Traffic Management (Iris)	<ul style="list-style-type: none"> • Focus: research and development in collaboration with SESAR to modernise air traffic control, including core technologies for 4D air traffic management system use by the Single European Sky Policy (SESP) • Partners: <ul style="list-style-type: none"> – SESAR

	<ul style="list-style-type: none"> - EUROCONTROL - ICAO
Small Geostationary Satellite (SGEO)	<ul style="list-style-type: none"> • Focus: telecommunications satellite platform for range of commercial payloads and services • Prime contractor: OHB System AG (Germany)
Satellite – Automatic Identification System (SAT-AIS)	<ul style="list-style-type: none"> • Focus: developing satellite-based AIS data to enhance European shipping industry tracking capability • Key institutional partner: European Maritime Safety Agency
Govsatcom Precursor	<ul style="list-style-type: none"> • Focus: development and demonstration of satellite services for governmental 5G applications • Key institutional partners: <ul style="list-style-type: none"> - European Commission - European Defence Agency • Eligibility: all member state satellite operators and service providers
Mega Constellations	<ul style="list-style-type: none"> • Focus: wide ranging support throughout R&D to all satellite constellations delivering communication services • Eligibility: all member state industry, institutional and trade-association entities from across the value chain
ScyLight	<ul style="list-style-type: none"> • Focus: development, demonstration, utilisation, and system and market studies for Optical Communication Technologies • Eligibility: industry parties authorised by participating member states' national delegations
Satellite for 5G	<ul style="list-style-type: none"> • Focus: trialling and coordinating satellite services for 5G roll out, in alignment with the European Commission on 5G • Joint statement signed by 16 European satellite industry leaders, including (from the UK) Avanti, Inmarsat, Network Access Associates and Satixfy.²⁹
Quantum	<ul style="list-style-type: none"> • Focus: telecommunication satellites that can be reprogrammed whilst in orbit to respond to geographical and demand variation. • Lead: Eutelsat (France) <ul style="list-style-type: none"> - Airbus (UK) - satellite and payload prime - SSTL (UK) - provision of platform - Sub-systems: Airbus (Spain), Space Engineering (Italy), Norspace (Norway), and Airbus (Netherlands)
Pioneer in-orbit demonstration	<ul style="list-style-type: none"> • Focus: a specialist in-orbit validation facility for European space industries, providing timely and cost-effective validation services. Partner companies deliver the platform's services. <ul style="list-style-type: none"> - Open Cosmos (UK) - Spire Global (UK) - Sitael (Italy) - Airbus (France)
Electra	<ul style="list-style-type: none"> • Focus: support to European industry to develop, launch and validate in-orbit an electric propulsion telecommunication satellite in the 3-tonne launch mass range.
Indigo	<ul style="list-style-type: none"> • Focus: development of ground segment technologies to optimise use of the next generation of high-throughput telecommunication satellites • Prime: Intelsat (Luxembourg) <ul style="list-style-type: none"> - Newtec (Belgium)
ECO	<ul style="list-style-type: none"> • Focus: development and demonstration of ground technologies and services in Africa to optimise use of Avanti's high-throughput satellite. Securing European competitiveness in the region • Prime: Avanti (UK) <ul style="list-style-type: none"> - Newtec (Belgium) - SatADSL (Belgium)

²⁹ <https://artes.esa.int/sites/default/files/20180622%20Joint%20Statement%20-%20-%205G%20-%20Signatories.pdf>

Appendix C Case studies

This appendix presents seven in-depth case studies, which look at a selection of ARTES projects and UK contractors recommended by UKSA. The cases have been developed based on desk research, survey results and interviews with relevant contractors and partners. They include the following:

- **Oxford Space Systems**, which has participated in four ARTES projects since it was established in 2013. The firm has quickly gone from company formation, through new material development, to successful in-orbit demonstration in just a few years, and has recently become the most highly funded UK start-up space technology business. OSS now has a number of core product lines in place, developed with ARTES support, and the company is approaching profitability.
- **SatixFy**, which moved to the UK to benefit from ARTES funding and has now invested €15M into two design centres with 77 staff. The company developed two new application specific integrated circuits (ASICs) through ARTES funding, which can replace traditional antennae on satellites. The first of many planned products based on these (a 256-element antenna) was released to the public in February 2019 and SatixFy is now developing the chips for commercial aviation connectivity.
- **Spire Global UK Ltd**, which is using ARTES Pioneer funding to become a complete Space Mission Provider (SMP) ecosystem – providing everything from design, build, test and operations facilities to public and private 3rd party customers that are in need of in-space validation. ARTES supported the development and launch of two new satellite systems with unique payloads to provide validation for parallel computing in space and for the exploitation of Global Navigation Systems Radio Occultation (GNSS-RO) signals for weather applications. Both offer the potential for unique and higher quality data for customers and offer new revenue streams for the company.
- **Proteus Geo and TCarta**, who merged and used ARTES funding to develop a global database and online portal that provides access to satellite-derived bathymetry (water depth measurements) data for coastal regions. The portal is now live and being used in a wide variety of areas, including engineering, construction, oil and gas, allowing TCarta to double in size. A follow-on project to develop a similar online platform for access to satellite-derived air quality data has also now begun.
- **Remote Diagnostic Technologies**, which has undertaken a series of ARTES projects relating to remote monitoring and resuscitation solutions. The ‘AMAZON’ project, for example, involved the development of a dual-use system (medical monitoring and telemedicine requirements in a single, compact, integrated unit) that made use of both satellite communication and navigation capabilities. The technology was cleared for market in 2013 and has already been sold to a number of NATO militaries, as well as companies in the oil and gas sector. Following the development of a series of follow-on technologies, RDT was wholly acquired by Philips Healthcare in 2018.
- **Rezatec**, which led several ARTES projects, including the ‘Peat Spotter’ study, concerned with the development of a data service (a landscape intelligence portal, based on satellite imagery) to enable more cost- and time-effective assessment and sustainable management of peatland. Further ARTES funding then supported the development of an updated and extended mapping, measuring and monitoring service (M3i) of land-based assets for the water, forestry, conservation and agribusiness sectors. Revenue from this new service is expected to total £10-£15M in the next five years.
- **Inmarsat**, which is the prime contractor for the ARTES public private partnership ‘Iris’, working to develop the next generation of Data Link Service to improve air traffic management in Europe. The system will only become fully operational in 2028, but is expected to bring various benefits for airlines, including fuel savings and increased airspace and airport capacity, as well as revenue from broadband-enabled cabins. Passengers and society will also benefit via reduced delays and flight times, as well as reduction in CO₂ emissions generated through improved flight trajectories.

Summary information is presented from all of the case studies to illustrate different outputs, outcomes and benefits discussed in the main body of the report.

C.1 Oxford Space Systems

Summary

- Oxford Space Systems (OSS) was established in 2013 and is headquartered in its own custom facility at the Harwell Space Cluster. It develops deployable antennas and structures for satellites, using novel, proprietary materials.
- The company brings an entrepreneurial approach to the sector, innovating to reduce complexity, development times and costs, and it aims to fill a gap in the market by offering a technology portfolio that can be scaled to accommodate the needs of a range of clients.
- OSS set a record for the space sector, going from company formulation, through new material development, to successful in-orbit demonstration in only a few years. ARTES has been a critical avenue for their growth, allowing the company to tackle high-value product development, the cost of which would be unattractive for the company's investors alone
- The company has participated in four ARTES projects over the course of the past 5 years, resulting in commercially viable products and materials that are now on the market. It has grown from 3 to 47 employees in this time.
- ARTES provided critical co-funding to unlock VC investment into OSS, particularly in the early years of the company – enabling them to undertake the more expensive, longer-term and riskier projects that investors would typically avoid
- The support from ESA has also been beneficial for attracting follow-on contracts and investment, both with primes (the programme helped OSS secure collaborations with Airbus Defence & Space, Thales Alenia Space and LuxSpace) and with the venture capital investment community.
- In late 2018 OSS secured its third and biggest round of VC funding, £7.9M, making it the most highly funded UK start-up, upstream space technology business (£12M in total in 4 years).
- The company now has a number of core product lines and is approaching profitability. But it also continues to innovate aggressively, modifying its core technology to meet bespoke requirements for satellite builders globally, especially targeting so-called 'mega-constellations'

Oxford Space Systems (OSS) develops deployable antennas and structures for satellites, utilising its novel and proprietary materials. It is based in its own custom facility at the Harwell Space Cluster near Oxford, giving it the largest clean room on campus and the capability for volume production.

Although a stand-alone company, its founder, Mike Lawton, and his original team had numerous connections and experience from their time in high technology research and development at space battery business, ABSL Space Products. The intention with the establishment of OSS was to bring an entrepreneurial approach to a space sector dominated by legacy companies, and revolutionise it by reducing the complexity, development times and launch costs of satellites.

Nearly every satellite that is launched has a deployable structure for solar power generation and communication. Yet, despite this inherent demand and large potential market, few disruptive advances had been made in the relevant technologies. OSS believes this makes it a drastically underserved and undeveloped market. The company is addressing this opportunity through the design of structures – it uses its own proprietary flight-proven materials, combined with conventional space materials and origami engineering techniques to provide a new range of products for the commercial space sector.

For example, it has developed and flight-proven a novel carbon composite material, known as AstroTube™ used for booms and antenna structures. It has also made use of another composite material that is capable of returning to an engineered shape upon deployment under micro gravity as a deployable reflector antenna.

OSS uses such approaches to decrease size, weight, cost and complexity, which also leads to shorter lead times, thus lowering overall launch costs. In a sector where a satellite launch can cost over £20k per kilo, any reduction in mass can be significant.

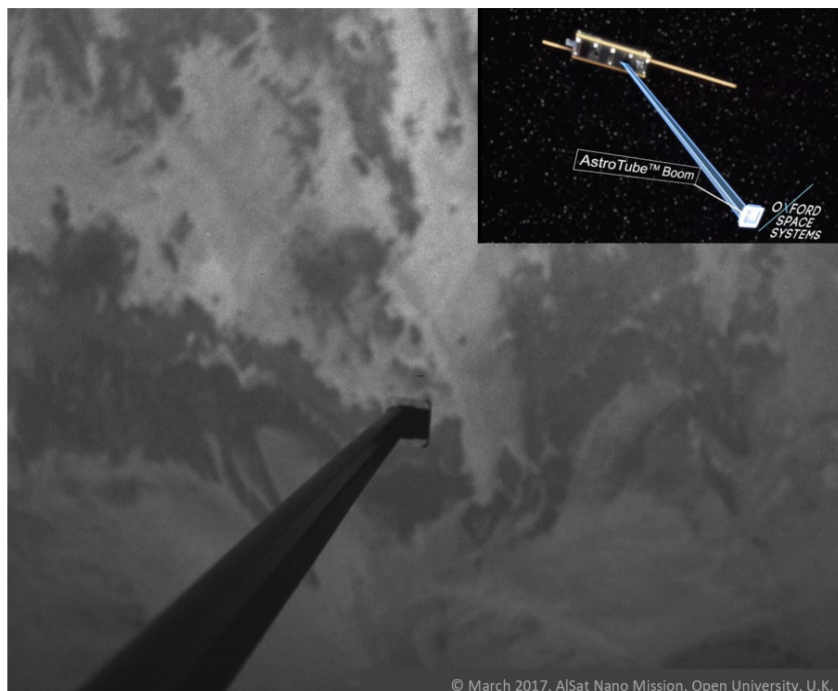

The Oxford Space Systems' AstroTube™ Boom developed and deployed on orbit in record time in October 2016. The technology will underpin a new range of deployable antennas and flexible solar arrays

OSS has also striven to challenge the economics of the space industry in other ways. The high cost of satellites is linked to high complexity, over-engineering, and complex double or even triple redundancies that are often built in. Designing their products to be fit for purpose, with very specific lifespans, OSS is able to reduce the time and cost from concept to orbit. So, whereas ESA and NASA state that the time from concept to launch of a new space material and then a product based upon that material can be up to 10 years, OSS has accomplished this in as little as 30 months.

Since 2013, OSS has participated in four ARTES projects³⁰. While some of these projects have led directly to commercially viable products and materials (which have now come to market), there have also been high levels of 'cross-fertilisation' between projects, particularly in the use of new materials.

OSS also commented that ARTES funding is an excellent mechanism to secure non-diluting funding, meaning the company had to raise less from the investment community and thus surrender less equity. This meant that the company was instead able to offer more enticing compensation to potential and current employees, including share options in the company. It can be difficult to attract top talent when large primes are competing for staff with higher salaries, so being able to offer something unique makes the company more attractive – every employee owns part of OSS.

Since its inception, the company has been able to grow from 3 to more than 47 employees – in part as a result of ARTES support. Indeed, the company believes that its trajectory would have been far more difficult without ARTES support, particularly during the early years.

The programme support has also meant that it has been able to act strategically, preparing for the long-term success of the company. Some of the projects that they undertake are very expensive and long term, and these are often the types of projects that investors shy away from. In seeking funds through the ARTES programme, the company has been able to reduce the risks to the company and its investors. By sharing the costs of development with the programme, the company has also been able to approach profitability far faster than anticipated.

For a small company, support from ESA also acts as a 'seal of approval', both with potential investors and with large primes. In many ways, working with ESA 'credentialed' the company and demonstrated its potential. With such significant institutional support, many investors were willing to buy-in. It also aided OSS in getting work from other firms including LuxSpace, Airbus and Thales Alenia Space.

³⁰ These are: Material Investigation of Flexible Composites [NeoSat]; Deployable Filar Array Antenna [SAT-AIS]; Scalable Deployable Panel Array (C&G); and Deployable Steerable Patch Panel Antenna Array for Microsats.

In late summer of 2018 OSS secured its third round of VC funding, with £7.9m from a syndicate of investors (including IQ Capital, Longwall Ventures, Foresight-Williams, OTIF, Midven and Wren), making it the most highly funded UK start-up, upstream space technology business.³¹ Since 2014, OSS has received more than £12m in private capital investment in total. The growing success of these public funding calls is a strong indication that the company is moving toward commercial success.

However, the company remains committed to further innovation in the satellite sector.

With a foundation of products now forming the core business of OSS, the company can now look to expand its product lines for satellites of all types. By developing a bespoke technology portfolio, OSS hopes to be able to alter any of their products and materials to meet most mission requirements. However, as OSS continues to push the boundaries of the satellite sector, the company is certain that it will continue to look to the ARTES programme for economic and institutional support.



New Oxford Space Systems' facility in Harwell, Oxfordshire. Photo Credit to OSS

Interview details:

- Interview with Mike Lawton, Founder & CEO of OSS
- Interview with Michael Loweth, Business Development Manager, OSS

³¹ <https://www.ukspace.org/news-item/oss-new-funding/>

C.2 SatixFy

Summary

- SatixFy are a satellite communications company, originally from Israel. The possibility of ARTES funding convinced the company to open two research centres in the UK.
- The company conceived of two new application specific integrated circuits (ASICs), capable of managing multi beam electronically-steered radar array. These would eliminate the need for traditional types of antennae, offering compact, light-weight and scalable circuit boards that could dramatically reduce production and launch costs.
- ARTES funding was essential for moving this concept forward and SatixFy successfully created an engineering sample within their two-year ARTES project. The two new ASICs came to market in November 2018 and the first of many planned products based on these (a 256-element antenna), was released to the public in February 2019.
- The chips also have potential applications beyond satellite communications – and SatixFy are working in collaboration with STE to develop the ASICs for commercial aviation in-flight connectivity. STE will invest \$20M in the project, but with the IP remaining with SatixFy UK
- Knowledge gained during the early stages of the ARTES project also led to the development and release of a new advanced satellite communication modem
- The increase in new products has led to an increase in the company's UK staff, from 27 to 77 – who are now spread across two design centres (Manchester and Farnborough). SatixFy has invested €15M into these centres in preparation for new products and future growth

SatixFy had conceived of two new application specific integrated circuits (ASICs), capable of managing a multi beam electronically steered radar array:

- The Beat radio frequency independent circuit (RFIC), capable of sending and receiving ku-band signals across any polarisation; and
- The Prime ASIC, which is able to electronically combine radiation patterns into a signal and do so across multiple beams and polarisations.

The combination of the two would allow for the development of compact and scalable electronically steered radar arrays, able to acquire multiple signals simultaneously. This would mean that a satellite using the chips could communicate with multiple ground stations along its path, while a land-based antenna could communicate with multiple satellites at different positions in the sky. The chips would eliminate the need for traditional types of antennae by forming, processing, sending and receiving a signal electronically. They would also improve the size and weight of satellites, by replacing traditional dish systems with circuit boards, dramatically reducing the cost of production and launch.

No similar products existed on the market, and so this would put SatixFy at the forefront of satellite communication technology. However, it was difficult to be sure in advance whether (or to what extent) the satellite community would adopt this revolutionary technology. Although the ASICs were well within SatixFy's capabilities and offered a lot of potential, their commercial success was not guaranteed. The

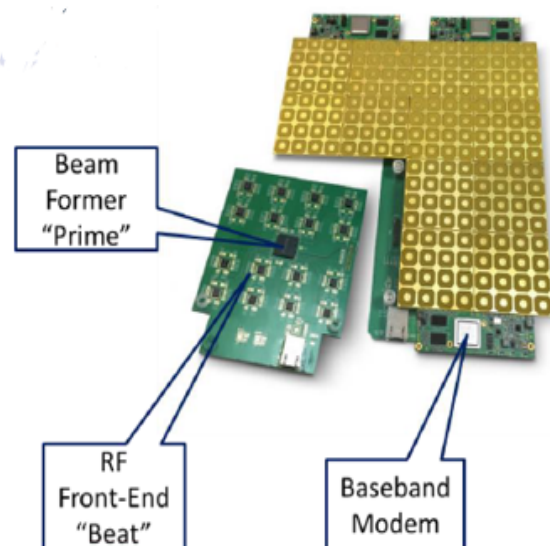

A circuit board with the Prime ASIC and Beat RFIC. Photo courtesy of the ESA

high development costs and unclear commercial future of the product were therefore enough to mean that SatixFy were unable to develop the ASICs independently, through their own funding or investment.

ARTES was the only funding stream that SatixFy was aware of that supported satellite technology during early stage development. Its core-competitiveness programme was known to assist next-generation technologies up until their first launch and proof of concept, and this was exactly what SatixFy were in search of. A proposal was therefore submitted for funding to support the development of the ASICs.

At a very early stage in the negotiations, there were indications that the UKSA and ESA were interested in supporting the project (based on the agency responses to 10 early stage questions, and the Outline Proposal), but there was a significant obstacle; SatixFy were based in Israel and had no presence in ESA member states. However, with ESA willing to fund up to 75% of the development and 50% of the product activation costs, SatixFy decided to open a new office in Farnborough, UK, with 27 employees.³²

In total the ARTES programme provided £11M of funding for the project, which was put towards the development of the two ASICs (Beat RFIC and Prime). The stated goal of the project was to create an 'engineering sample' within two years, which would represent the final step before beginning production. SatixFy met this goal and have subsequently brought the two new ASICs to market in November 2018. The first of many planned products based on the ASICs, a 256-element antenna, was also released to the public in the first week of February 2019.³³

Despite these successes, there is still some uncertainty about how the product, and the satellite communication marketplace more generally, will grow in the coming months and years. At this early stage, the only user of the chips is still SatixFy – but other collaborations are currently in development.

The capacity of the chips makes them useful in applications that require a satellite link. However, the chips also have potential applications beyond satellite communication, for example in relation to drones, defence, aeronautical communication on the move, or the internet of things (cars, tractors, etc.). As such, Singapore Technologies Electronics (STE) Limited are now working with SatixFy to exploit the new ASICs for commercial aviation in-flight connectivity. STE will invest \$20M into this project, with the technological ownership (IP) remaining with SatixFy in the UK.

The company has also been able to leverage new knowledge gained as a result of ARTES funding in other development projects. For example, based on the knowledge gained during the early development of the ASICs, they made new connections which led to the development and release of a new advanced satellite communication modem, alongside the new chips.

The increase in new products (both the payload solutions and advanced modems) has required SatixFy to hire more staff. Since receiving ARTES funding, the company (in the UK) has grown from an initial staff complement of 27 to a total of 77, divided between their (now) two design centres in Manchester and Farnborough. SatixFy has invested €15m into these centres (IP, personnel and infrastructure) in preparation for the development of new products and further growth in the future.

SatixFy reflected that ARTES funding has had a 'tremendous impact' on the company, propelling it forward in a number of ways and creating opportunities that otherwise would just not have existed. The value of the programme extends far beyond simply supporting the cost of development.

The completion of the project on time, with the successful production of the ASICs, has validated SatixFy's capabilities in the sector. The Minister for Investment at the Department for International Trade, as well as the Chief Executive of the UK Space agency, have both held up SatixFy as an example for others to follow.

Interview details:

- Interview with Moche Cohen, VP of Research and Development, SatixFy

³² <https://www.prnewswire.com/news-releases/satixfy-uk-announces-availability-of-2-new-asics-digital-beam-former-prime-and-ku-band-rfic-beat-enabling-amazingly-thin-electronically-steered-multi-beam-antennas-300746547.html>

³³ <http://www.satixfy.com/news/satixfy-launches-worlds-first-silicon-based-electronically-steered-multi-beam-array-antenna/>

C.3 Spire Global

Summary

- Spire Global is a satellite-powered data company that gathers unique and proprietary data from a large constellation of nanosatellites. It specialises in the design, build, launch and management of a global constellation of low-earth-orbit nanosatellites, LEMUR satellites.
- The company has launched more than 90 satellites since their inception in 2012, combined with 30 ground stations to provide proprietary and unique data to their customers.
- Spire is using ARTES Pioneer funding to become a complete Space Mission Provider (SMP) ecosystem – providing everything from design, build, test and operations facilities to public and private 3rd party customers that are in need of in-space validation.
- Specifically, ARTES supported the development and launch of two new satellite systems with unique payloads to provide validation for parallel computing in space and for the exploitation of Global Navigation Systems Radio Occultation (GNSS-RO) signals for weather applications. Both projects offer the potential for unique and higher quality data for customers and therefore serve as precursors for new revenue streams for the company.
- The satellites were ready for launch just 6-months after contract award, and within one week of deployment they were harvesting GNSS signals to provide frequent low earth orbit weather data (temperature, pressure, humidity). Spire estimate that this new weather data will be worth \$2.7 billion to the company over the next 25 years.

Spire Global Inc (Spire) was founded in 2012 in San Francisco, California. In 2015, the company expanded into Europe, opening an office and satellite manufacturing facility in Glasgow, Scotland. They were supported in this expansion by UKSA and a grant from Scottish Enterprise. Scotland was attractive for the company because of the relatively low costs, and the ample supply of highly trained technicians, engineers and scientists. This is reflected in the rapid growth of Spire in the UK, from an initial team of 10 in 2015, to their current staff of 57 (as of March 2019). Although they did not receive ARTES funding before they opened their office in Glasgow (without a base in Europe they were ineligible), the support given to the space sector in the UK was a meaningful part of the decision-making process. Since then Spire have invested £20 million pounds into their local business infrastructure.³⁴

Spire offer data services for a number of applications including maritime and airborne tracking, as well as data for use in weather forecasting. Spire boasts the world's largest ship tracking, aviation tracking and commercial weather data constellations. They do not interpret the data themselves, but offer data through B2B services on which clients develop comprehensive products for their customers. The data is then used in many applications to provide valuable insight to end users, preparing them to make critical business / operational decisions.³⁵

Unlike almost every other actor in the sector, Spire have developed their own space programme, designing, building and managing a constellation of low-earth-orbit nanosatellites. There are currently 72 Spire satellites in orbit, gathering data across the globe with a variety of payloads. Spire decided to develop its own space programme in order to have complete control over the quality of the satellite derived data at every point in the supply chain. From the satellites to payloads, ground stations and data processing, Spire can maintain the high standards necessary for their clients. This means that Spire is able to offer this service, as a complete package, to other payload designers.

³⁴ <https://www.holyrood.com/articles/inside-politics/scotland-space-%E2%80%93-spaceports-and-satellite-manufacturing>

³⁵ <https://spire.com>

Spire was awarded £4m (€4.9m) of funding through the ARTES Pioneer programme, as part of ESA's mission to develop companies into Space Mission Providers (SMPs). This should result in an entirely new ecosystem in which SMPs are able to offer a broad spectrum of capabilities and competencies, alongside the infrastructure necessary to run satellite operations. This is distinct from other aspects of the ARTES programme, which often require the development of a specific product. Pioneer challenged Spire to demonstrate their capacity as an SMP for in-space validation, with the intention of increasing opportunities for 3rd party public and private customers to test, prove, and validate products in orbit. To accomplish this, Spire acted as its own client, developing entirely new payloads that could be launched on their existing satellite bus architecture.

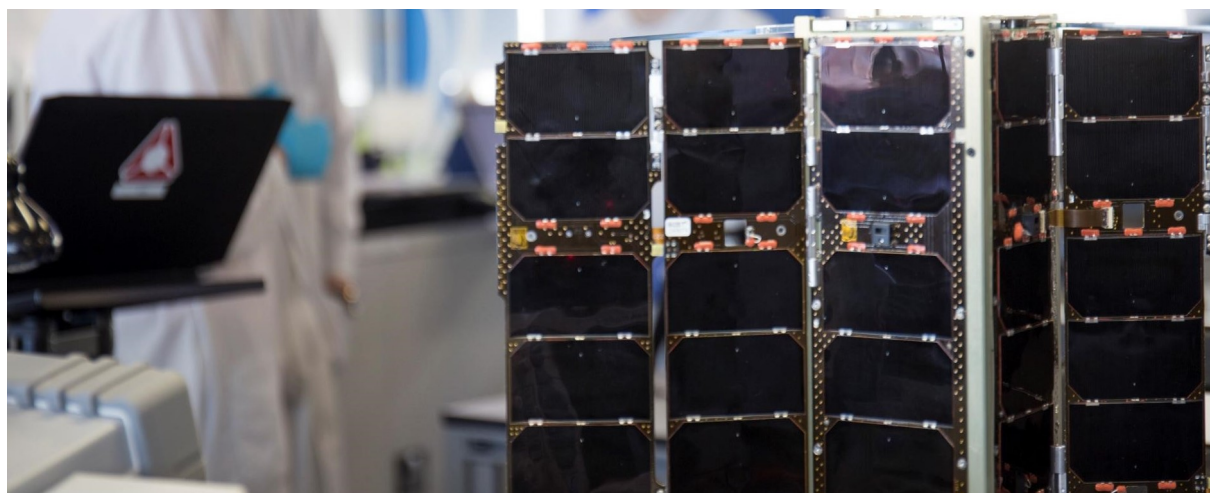

Detail of an unfurled LEUMUR Satellite. Photo Credit to Spire Global

The rationale for developing SMPs is to lower the costs and other barriers to entry in the space sector. Even with a successful proof of concept, companies often face long delays before an opportunity for in-space validation arises. Spire is the only company in the UK and one of only one or two companies globally launching satellites every few months, eliminating the long wait. Since their satellites are all of the same variety, Spire are also able to adjust their launch schedules according to the readiness of the payloads. This provides their 3rd party clients the flexibility required for new businesses, that often experience difficulties leading up to a first launch. This capacity is critical to the ARTES Pioneer programme. The flexibility offered by Spire, will allow the burgeoning space sector in the UK and Europe to continue its growth unabated.

Over the course of this project, Spire was able to build and test (e.g. updating of hardware and software) the new satellites within three months, which was significantly shorter than the 2-3 years that most commercial and government projects require.³⁶ This was driven by Spire's rapid development cycles, typically lasting between 2-3 weeks. With all of their testing, prototyping and engineering in house, Spire are able to adapt quickly to any required changes. The satellites for the ARTES programme were then launched in November 2018, just nine months after contract award, and are now actively demonstrating their potential. They would have made it to orbit even more quickly, with an intended launch in September 2018 (6-months from the start of the project), if not for the failure of an unrelated Soyuz rocket. These are the types of timescales that will be possible for clients seeking to launch payloads with Spire.

³⁶ <http://www.iceaaonline.com/ready/wp-content/uploads/2014/03/Davis-Satellite-ICEAASoCal-090915.pdf>

There are even further opportunities for growth, with news that the UK will be developing a new spaceport in Scotland. Spire will then have the capacity to design, build, test, launch and operate their satellites from Scotland. Although this capacity is still a few years away, Spire is already excited about this prospect according to CEO, Peter Platzter.³⁷

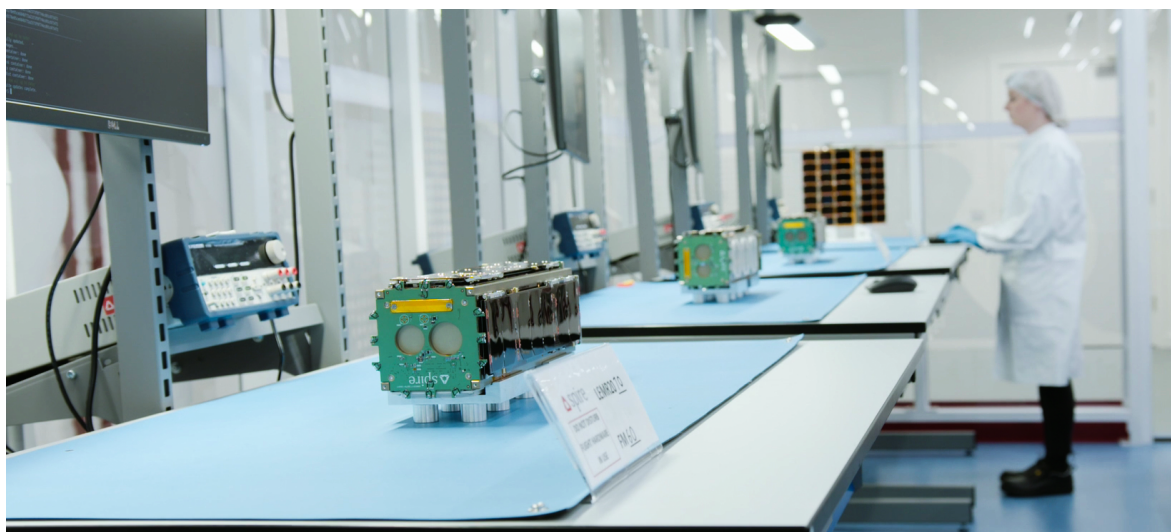

Spire Satellite cleanroom in Glasgow, Scotland. Photo Credit to Spire Global

Other portions of the funding contributed to the development of new products, including antenna and payloads for GNSS-RO signal acquisition and parallel supercomputing in space. Working with ESA has significantly de-risked this development work by covering half of the costs. Both of these projects develop new capacities for Spire, offering new types and higher qualities of data for use by their customer base. To date, not all aspects of the project have completed in-orbit demonstrations. The next phase of these projects will be to transition them from the demonstration phase, funded by ARTES, and into full scale production.

Using the already established network of GNSS, the nanosatellites use the existing signal to provide low-earth orbit weather data. They are capable of harvesting 25% of GNSS-RO signals available and this capability was operational just one week after launch.³⁸ The processed data will be made available more widely, and will provide scientists with access to temperature, pressure and humidity information, all of which can be used in weather forecasting.³⁹ The capacity to gather this data was drawn from their existing work acquiring the same type of data from GPS satellites. This collection of GNSS-RO data exhibited the framework required and reliability of GNSS-RO data to ESA. This should lead to further exploitation of this data by the ESA in the future. The link between Spire and the EU positioning system ensures that there will be continuous and long term access to this vital data stream. The data has the potential to be a critical revenue driver for Spire, with an estimated worth of \$2.7 billion over the next 25 years.⁴⁰

In seven short years Spire has grown rapidly, having completed three rounds of VC investment totalling \$135m USD. They have also expanded globally, opening offices in Singapore and Luxembourg. ARTES has created opportunities for Spire to enter into new and exciting markets. Spire has leveraged their participation in ARTES to benefit from their heritage and track record in nanosatellite development. Spire would undoubtedly work with ESA again in the future.

Interview details:

- *Dr. Hina Khan (Project Coordinator, Spire Global UK Limited)*

³⁷ <https://www.scotland.org/news/scotland-to-reach-new-heights-with-europes-first-small-satellite-launch-fac>

³⁸ <https://globenewswire.com/news-release/2018/12/11/1665433/0/en/Spire-Taps-Galileo-for-Space-Based-Weather-Data.html>

³⁹ https://www.esa.int/Our_Activities/Telecommunications_Integrated_Applications/Lift_off_for_Pioneering_nanosats

⁴⁰ <https://www.cnbc.com/2018/12/11/spire-global-gets-2point7-billion-weather-data-partnership-from-galileo.html>

C.4 TCarta / Proteus Geo

Summary

- TCarta/Proteus Geo specialise in using satellite data to derive databases and online platforms.
- ARTES funding was used to develop a global database and online portal, providing access to satellite derived coastal bathymetry – i.e. water depth measurements by satellite – based on techniques developed by TCarta.
- Bathymetric data near the shoreline can be expensive to obtain, requiring extensive investment in personnel and equipment. Collecting this via satellite eliminates the primary costs, while also reducing the production time.
- ARTES funding incentivised the merger of Proteus Geo (UK) and TCarta (US), leveraged €1M from each firm, and enabled the platform to be developed at twice possible otherwise. ESA also supported promotional activities, giving the company and project wider exposure.
- The portal is now live and allows customers to purchase data online, anywhere in the world, at any time. It is being used in a wide variety of areas, including engineering, construction, government data and the oil and gas industry.
- This additional business has enabled TCarta to increase in size, from 10 to 27 employees (including 13 in the UK).
- The original bathymetry project has also led to further collaborations and funding in other related areas. For example, TCarta is working with Kings College to develop a similar online platform for access to satellite-derived air quality data (again, with the support of ARTES funding).

Although satellite derived bathymetry (SDB) – i.e. water depth measurements by satellite - has been possible for some time, its use has been limited mainly to academic circles. Proteus Geo, later merging to become TCarta, wanted to change that.

The company felt that it was possible to create a user friendly and more widely accessible platform for commercial satellite derived bathymetric data. A clear gap in the market was also identified in relation to coastal regions, where little data was available because of interference from both man-made objects and variance in sea floor sediments. Despite these difficulties, Proteus Geo felt they could offer accurate SDB data, while also transforming their own business model from being dependent on individual projects to one where institutional and business clients could pay to find and download data whenever they required it. They sought ARTES funding to support the development of a portal to do just this.

TCarta and Proteus Geo were both involved with undersea mapping prior to their merger. TCarta had a global dataset of ocean depths at 90m resolution, collected from multiple data sources. Proteus Geo was already working on the development of its datasets for the Bathymetry portal, while also developing SDB data for individual projects and clients. Their businesses complemented each other, and they decided to merge in 2017. The prospect of ESA funding provided an added incentive to do so.

The stage-gate approach employed during the ARTES application process was reportedly very helpful for the company. Each stage forced the company to further hone their objectives and validate their approach. This ultimately made the eventual implementation of the project go more smoothly.

The ARTES funding was contingent on matched company investment, and ARTES and TCarta each contributed €1m to develop the platform within a timespan of 18 months. The company was so confident that they diverted their own profits to match the ESA funding, instead of seeking the money from external investors. However, the ESA funding was still critical, enabling TCarta to move forward with the project far more quickly than would otherwise have been possible. In addition to the beneficial injection of funding, the ARTES requirement that they create the Bathymetry Portal by the end of the project period also kept the development team focused and on track to succeed during the course of the project. The company estimates that it would have taken 3-5 years to complete the project on their own,

50%-70% longer than was achieved with ARTES funding. At the speed that the EO industry moves, it is likely that the company would have missed their opportunity had they continued to develop the portal without external support.

At the end of the eighteen-month award, the Bathymetry Portal went live for users, providing shallow water SDB data for the entire globe. The portal is designed to have three resolutions available (2m, 30m and 90m), with costs increasing as the resolution improves. The 90m dataset was a legacy of TCarta before the merger. The SDB data (2m and 30m), incorporated as part of the project, can be provided to the end user at a much lower cost and with much greater speed, than that collected by aircraft or boat. SDB also allows for the provision of data where security, environmental and political concerns may prevent in-situ work.

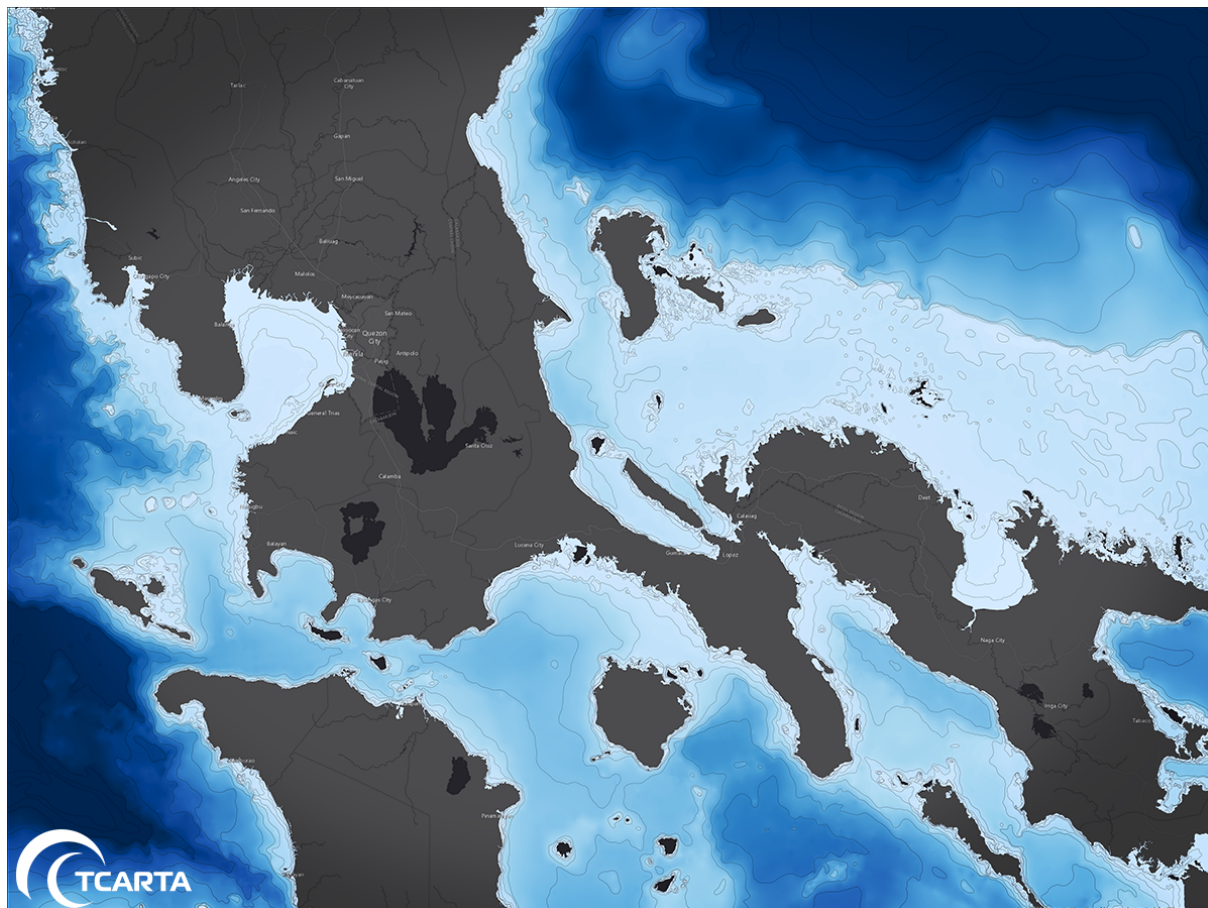

A 90m resolution two-dimensional satellite derived bathymetry map of the Philippines produced by TCarta

ESA aided the company with the production of videos and other promotional material linked to the project, which have dramatically increased TCarta's exposure.⁴¹ The company was also asked to present at ESA events, which had a similar impact on the brand. The Portal itself has also proved to be a very successful marketing tool for the company. Many clients have got in contact after finding the Portal online, allowing TCarta to discuss their needs in more depth and provide a custom data set.

The primary users of the new Bathymetry Portal service are engineering consultancies, governments and the oil and gas industry. TCarta worked with AECOM, a global infrastructure services company, to test the Portal initially, and other users are now employing it in construction, coastal development, modelling, seabed exploration and even filling gaps in existing government data.

Prior to the start of the ARTES project, Proteus Geo only had a team of 4 people. The funding allowed the company to immediately hire more staff, as well as support the idea of a merger between Proteus

⁴¹ <https://www.youtube.com/watch?v=ADo8TuxWSWI>

Geo and TCarta. The merger increased the total staff to 10. Today, with increased business, there are 27 staff spread across their offices in Bristol (13), Denver (10), and Abu Dhabi (4).

The Bathymetry Portal project has also fed into new work with satellite derived data. For example, TCarta have since formed a partnership with King's College London (KCL) to develop an online platform for satellite derived air quality data (also ARTES-funded).

KCL already used sensors in London to provide an accurate map of air pollution in the city. Many other municipalities around the world had asked for a similar service, but without the data collection it was impossible to replicate. Now TCarta has developed a satellite derived model of measuring cars on the move, which contribute an array of harmful pollutants. Combining this satellite derived data, with KCL's air quality model will allow for a satellite derived global air quality chart, allowing them to meet wider demand.

TCarta's experience during the Bathymetry Portal project proved that they are capable of delivering projects that are global in scale. Their confidence has propelled them to bring more aspects of the development process in house, making them a one stop shop for satellite derived data and platform development.

Interview details:

- Interview with Richard Flemmings, Operations Director, TCarta

C.5 Remote Diagnostic Technologies – AMAZON project

Summary

- Remote Diagnostic Technologies (RDT) is a medical device company developing remote monitoring and resuscitation solutions.
- It has undertaken a series of related ARTES projects, including AMAZON, which sought to develop a dual-use system (medical monitoring and telemedicine requirements in a single, compact, integrated unit), making use of both satellite communication and navigation capabilities.
- The ARTES funding for AMAZON enabled RDT to expedite the development of this technology, which was cleared for market in 2013 and has already been sold to a number of NATO militaries, as well as companies in the oil and gas sector.
- Subsequent ESA funding is helping to develop related products for broader implementation (e.g. in the context of civilian pre-hospital care). This includes a defibrillator that has been adopted by, amongst others, the UK Helicopter Emergency Medical Services and the Dutch Ambulance Service.
- In 2018, RDT were wholly acquired by Philips Healthcare (for an undisclosed price), with RDT's extensive portfolio of emergency care solutions complementing Philips' Therapeutic Care business.

Remote Diagnostic Technologies (RDT), established in 1997, is a medical device company specialising in the end-to-end development of remote monitoring and resuscitation solutions for pre-hospital and critical care settings⁴². Their focus is on addressing the challenge of how to effectively monitor patients in remote locations and then securely transmit this real-time clinical data to the next level of healthcare.

They achieved their first success with a 2006 ESA-backed project to develop a remote telemedicine system for use by non-medical professionals within the commercial aviation industry. The resulting technology, Tempus IC⁴³ allowed airlines (e.g. Virgin Atlantic, BMI, Etihad and Emirates) to access medical monitoring equipment that enabled staff to connect with medical experts on the ground. The technology was also successful in other sectors, such as the luxury yacht industry and ship building¹.

RDT then received further ESA funding via the ARTES programme, for a project entitled AMAZON.

Frequently, clinical staff working in remote and under-served locations only have access to traditional vital sign monitoring solutions or non-integrated telemedicine systems, which can potentiate the challenges associated with an already difficult environment. The purpose of AMAZON was therefore to further develop the Tempus IC technology to provide a dual-use system. This would provide all medical monitoring and telemedicine requirements in a single, compact, integrated unit⁴⁴, making use of multiple space assets including satellite-communication and satellite-navigation⁴⁵. Specifically, the enhanced device was to include: additional diagnostic and monitoring capabilities (including ECG, temperature sensors and invasive blood pressure), the ability to integrate with other systems (e.g. digital stethoscope, digital x-ray and third-party electronic patient data sharing), and the utilisation of space-based services (e.g. broad and narrow band satcom, VoIP, data and image sharing and GPS positioning).

The potential benefits to end-users included a reduction in costs resulting from avoided medical evacuations from remote sites; improved usability, allowing healthcare providers other than doctors to use the equipment; improved workforce utilisation in existing customer sites; and enhanced capacity in remote sites via the integration and transmission of clinical data.

International SOS (Intl SOS), which provides medical and security services to industrial and governmental organisations across the globe, were brought onboard as a subcontractor for the duration

⁴² <https://www.rdtltd.com/about-rdt/>

⁴³ <https://www.rdtltd.com/products/tempus-ic2-telemedicine-monitor/what-is-tempus-ic2/>

⁴⁴ https://business.esa.int/sites/default/files/20_AMAZON_exerpt%20council%20brochure.pdf

⁴⁵ <https://www.rdtltd.com/products/tempus-ic2-telemedicine-monitor/what-is-tempus-ic2/>

of the project. Intl SOS were able to provide access to a number of pilot test sites for the technology and were also well positioned to provide operational feedback⁴⁶. In addition, they were able to gather feedback from a broad range of potential end-users regarding usability (which is a key consideration in the development of medical devices) and provide a platform for validation of the service⁴⁷.

The project involved two validation campaigns, of 6 weeks duration, at project sites of Intl SOS (Algeria and Nigeria), which were completed in 2012⁴⁸. During this time, 53 successful connections were achieved, reaching a cumulative total of over 5.5 hours of telemedicine calls⁴⁹. The project outcomes were assessed using a tool that was developed by a separate project – ASSIST⁵⁰ - funded through ESA's General Studies Programme. The ARTES funding enabled RDT to expedite the development of the Tempus technology, which would have taken significantly longer without this investment. In turn this maintained their competitiveness and market position while also providing them with the significant kudos associated with ESA funding. This was of particular benefit given the relatively small size of the company at the time and the fact that it allowed RDT to recruit further staff.



A Tempus Pro device. Currently in service with public, private, and military end-users

Tempus Pro was cleared for market with both CE marking and 510k (FDA) approval in June 2013⁵¹ and has already been sold to a number of NATO militaries and the oil and gas industry.

As a direct follow-on to the AMAZON project, RDT were also awarded further ESA funding to develop a range of products to facilitate broader implementation and to allow access to broader markets including the civilian pre-hospital care market through added cardiac electro-therapy solutions⁵². This new project phase is called Jackson. To date the defibrillator (Tempus LS) has received a CE mark and has

⁴⁶ The company has global infrastructure consisting of an extensive network of offices in over 1,000 locations. These offices are staffed by over 5,200 medically trained personnel including physicians, nurses and paramedics who are able to provide rapid and direct medical care when required.

⁴⁷ <https://business.esa.int/sites/default/files/2.1-RDT-presentation-ESA-Mar-12-v3.pdf>

⁴⁸ <https://business.esa.int/sites/default/files/2.1-RDT-presentation-ESA-Mar-12-v3.pdf>

⁴⁹ <https://business.esa.int/projects/amazon>

⁵⁰ <https://business.esa.int/projects/assist>

⁵¹ <https://www.accessdata.fda.gov/scripts/cdrh/cfdocs/cfPMN/pmn.cfm?ID=K130773>

⁵² <https://business.esa.int/projects/jackson-amazon-ccn1-temp>

since been launched in key adopter sites including the Helicopter Emergency Medical Services (HEMS) in the UK and the Dutch Ambulance Service. In 2017, RDT also launched the Tempus ALS system, which combined the monitoring capabilities of Tempus Pro with the Tempus LS defibrillator, to provide an integrated solution. The solution has allowed RDT access to the \$4 billion civilian pre-hospital monitor defibrillator market, with the company's annual turnover increasing from £10.3M in 2016 to £17.6M in 2018⁵³.

The company has also made a significant investment into its software platform, CorsiumSuite, which complements the Tempus monitoring technology, allowing clinicians access to real-time data, enabling them to make more informed clinical decisions that in turn have the potential to improve patient outcomes. The platform received a full CE mark in November 2018 and has received a strong initial market response. The software is currently being launched in key adopter sites and is expected to further differentiate RDT from their competitors⁵².

More recently, in June 2018, RDT were wholly acquired by Philips Healthcare [for an undisclosed price]⁵⁴, on the basis that RDT will strengthen Philips' ability to enter new markets and drive digital transformation and innovation within the healthcare sector. Furthermore, it was felt that RDT's extensive portfolio of emergency care solutions would complement Philips' Therapeutic Care business and strengthen its market position. This was seen by ESA as an important 'financial exit' for their investment in RDT, via the ARTES Business Applications element and will strengthen Philips position in the €1.4 billion resuscitation and emergency care market⁵⁵.

Moving forward RDT are looking to expand their R&D pipeline, specifically considering areas such as community medicine, where remote telemonitoring devices could be used to monitor chronic diseases. In settings such as this, telemonitoring could optimise the allocation and use of resource within the NHS, freeing up clinician time and negating the need for patients to travel long distances to be seen in clinics.

Interview details:

- Interview with Leigh Cornock, Director of R&D, RDT Ltd.

⁵³ RDT income statement 2018.pdf

⁵⁴<https://www.philips.com/a-w/about/news/archive/standard/news/press/2018/20180627-philips-and-jackson-health-system-sign-groundbreaking-11-year-agreement-for-enterprise-monitoring-as-a-service.htm>

⁵⁵ <https://business.esa.int/news/Philips-acquire-ESA-BA-funded-RDT>

C.6 Rezatec – Peat Spotter

Summary

- Rezatec – a spin-off from UCL - provides geospatial data analytics to a broad range of customers in the agribusiness, oil and energy, water, forestry, urban infrastructure and commodities sectors.
- The company has led several ARTES projects, including an initial feasibility study (Peat Spotter) to develop a data service (a landscape intelligence portal, based on satellite imagery) to enable more cost- and time-effective assessment and sustainable management of peatland. Such land is important for carbon capture, as a source of drinking water, and as a habitat for plants and animals.
- Further ARTES funding was then obtained for a demonstration project for an updated and extended mapping, measuring and monitoring service (M3i) of land-based assets for customers in the water, forestry, conservation and agribusiness sectors. This included pilot projects with water utility, forest management and tropical conservation organisations. South West Water (UK) participated in one pilot, providing ground-collected data in exchange for insight into the potential uses of remote technology within their business.
- In the period since 2014, Rezatec has expanded their client base considerably, from 5-6 regular users to 30-40 users at present. It has been awarded £1M in seed financing (2016), as well as new equity funding (2018), and now has a multi-million pound revenue stream from the M3i service (the company estimates £10-15M in income over the next 5 years). The company has also set up two satellite offices, in North America and Ireland.
- Rezatec is continuing to build upon its work with ESA, and plans to provide an ever increasing array of satellite data to its customer base.

Rezatec spun-out of University College London (UCL) and provides geospatial data analytics to a broad range of customers in Agribusiness, Oil & Energy, Water, Forestry, Urban Infrastructure and Commodities sectors⁵⁶. Now headquartered within the Harwell Space Cluster in Oxfordshire, the company has led several projects under the ARTES programme.

Peat Spotter, launched in 2014, was supported as part of the ARTES Integrated Applications Promotion (IAP) programme. The project was originally conceived with the aim of developing a cost-effective data service to enable sustainable peatland management, to reduce the amount of expensive and time-consuming field work traditionally required to gather information regarding peatland location, intactness and carbon content⁵⁷. The project objective was to give landowners an easier and cheaper way of calculating the potential economic value of conserving or restoring their peatlands to allow them to monitor their investment. The technology uses satellite imagery to locate and create initial mappings of peatlands, which are then validated with ground data collected by field agents using handheld devices. For context, Peatlands account for only 3% of landmass but capture twice as much carbon as all of the planet's forests combined⁵⁸. They are also a vital source of drinking water and exist as a habitat for many rare plants and animals, therefore the conservation of these areas is highly important.

The nine-month feasibility study which completed in late 2014 resulted in the development of the landscape intelligence portal⁵⁹. This allows users to monitor a landscape using map layers derived from Earth Observation imagery, combined with other satellite data sets, as a cost-effective alternative to extensive field work campaigns. As a follow-on to the study, Rezatec received further ARTES funding to undertake a demonstration project to develop and commercialise its M3i (map, measure and monitor) service⁶⁰. The subscription-based M3i service provides an updated application which maps, measures

⁵⁶ <https://www.rezatec.com/about-us/>

⁵⁷ <https://business.esa.int/projects/peat-spotter>

⁵⁸ http://www.esa.int/Our_Activities/Telecommunications_Integrated_Applications/Satellites_for_peat_s_sake

⁵⁹ <https://business.esa.int/projects/showcases/geospatial-data-analytics-for-landscape-intelligence>

⁶⁰ <https://business.esa.int/projects/m3i>

and monitors land-based assets for customers in the water, forestry, conservation and agribusiness sectors. Three separate pilot projects, including commercial partners, were completed in the sectors of water utility, forest estate management and tropical conservation.



Rezatec combined in-situ and EO data to provide accurate peat measurements across large areas

Water utility companies using the service have the ability to identify areas of degraded peatland and therefore make restoration efforts at source, thereby reducing the potential water treatment required to meet stringent drinking water standards². One of the pilot projects was undertaken with South West Water (SWW) in the UK, who were able to provide Rezatec with ground-collected data to validate the M3i service. This was a beneficial experience for SWW who were able to gain access to the platform at low to zero cost during this pilot phase, in addition to gaining valuable industry insight regarding the broader potential uses of remote technology within their business, such as water leak risk analysis. A number of the beta testers employed during the feasibility study, remain as end-users

today.

Rezatec noted that the ARTES programme actively encourages projects to progress from feasibility towards demonstration in a non-competitive manner, creating a reliable pipeline towards commercial viability. For them, the funding was key to their early commercial success as a company and allowed them to expedite their journey within a competitive market. In addition, the reliability and structure of the ARTES funding, allowed them to plan and forecast which was 'hugely valuable' for them as a SME.

Since the beginning of the Peat Spotter feasibility study Rezatec has expanded considerably both in terms of client and employee numbers. The introduction of their M3i service, allowed Rezatec to increase their client base from 5-6 regular users to approximately 30-40 users at present. In 2016, Rezatec announced the completion of a £1 million seed financing round, led by Run Capital with support from the Harvard Business School Alumni Angels, which facilitated the expansion of Rezatec's global sales and marketing infrastructure, allowing the company to respond to its rapidly increasing global customer base⁶¹, especially within the much larger global forestry and water sectors. This expanding global presence was compounded by the creation of 2 satellite offices in North America and Ireland. More recently, in 2018 the company achieved further equity funding through a new investor, Newable Private Investing, who provided further investment in response to a number of new customer contracts in North America and Asia-Pacific⁶². Rezatec credits their ability to achieve this follow-on funding, both via grants and venture capital, to the exposure they were able to achieve through ESA funding.

As a result of their commercial success, with an estimated potential income over the next 5 years at £10-15 million, the company now uses grant funding as a means to expedite product launch, rather than to ensure commercial survival. Rezatec have also been able to expand their company skill set and knowledge base. Specifically, the development of robust data models and reliable methodologies underpinned by agnostic source data, has allowed the team to expedite follow-on product development and apply a client centric approach based on their bespoke user requirements. The company currently offers a range of satellite-derived landscape intelligence products (across water management, forestry, agriculture, urban infrastructure and commodities) which can all be tracked back to the early work completed during the Peat Spotter feasibility and M3i demonstration projects. The company are also

⁶¹ <https://www.rezatec.com/rezatec-announces-1m-pound-seed-funding-round-to-deliver-satellite-data-analytics-to-customers-worldwide/>

⁶² <https://www.rezatec.com/rezatec-supports-continued-company-growth-move-new-global-headquarters/>

planning to launch a more comprehensive solution for their clients within the forestry sector within the next few months.

Another ARTES funded project, URGED, involved the use of Earth Observation (EO) data to address the growing global requirement for predictive decision support tools related to urban infrastructure. Specifically, this data was to be used to develop a service whereby managers of urban infrastructure could be better placed to be resilient and proactive towards environmental and societal threats⁶³. The system makes use of EO data, GNSS and Satellite Communications to provide data relating to water utilities (pipeline failure risk), urban infrastructure management (subsidence and flood risk), town/city authorities (mapping urban green space, roof space and thermal monitoring).

Interview details:

- Interview with David Smith, South West Water (took part in pilot studies, although they did not go on to procure follow-on services).
- Interview with Christina Wood, EFECA (subcontractor)
- Interview with Tim Vallings, VP Global Resources, Rezatec.

⁶³ <https://business.esa.int/projects/urged>

C.7 IRIS (Inmarsat)

Summary

- Inmarsat is a UK satellite telecommunications company, offering global mobile services. It is the prime contractor of Iris, an ARTES Public Private Partnership developing the next generation of Data Link Service to improve air traffic management.
- Iris will allow pilots and controllers to collaborate on flight trajectories and calculate the shortest available routes, cruise at optimum altitudes, and use continuous climb and descent paths, saving fuel and improving the environment. Also, the Iris solution is expected to protect aircraft communications from cyber threats with secure gateways.
- Iris is part of a much broader European push to modernise air traffic, and it has included the participation of a large number of key players from air traffic management, air transport, aeronautics and the satcom industry. Other UK partners include CGI IT UK Ltd, Helios Technology, Honeywell UK, NATS (En route) plc and SITA Information Network Computing UK Ltd, all of which are expected to benefit from participation in the programme.
- The system will become fully operational in 2028. As such, commercial gains are difficult to calculate at this point in time. However, there are various benefits that are expected to arise for airlines including fuel savings and increased airspace and airport capacity (due to better route optimisation), incremental revenue from broadband-enabled cabins. Passengers and society will also benefit via reduced delays and flight times, as well as reduction in CO₂ emissions.
- Based on prior studies, and the share of passenger traffic of UK airlines (BA), we estimate that the benefits of broadband-enabled ancillary revenue to the UK could be in the order of \$1.4million by 2035.
- Inmarsat also points out other benefits emerging from collaboration with ESA, including access to large scale budgets, the ability to incorporate companies working in different downstream areas out of the space sector, the ability to link up with regulators, and technical knowledge and support (mostly related to the issue of standards).

Iris is a Public Private Partnership led by Inmarsat (a UK satellite telecommunications company, offering global mobile services). Iris is a Data Link Service (DLS) satellite system funded and promoted by ESA and lead by Inmarsat (prime contractor). It is based on Inmarsat SwiftBroadband-Safety technology that is already certified for oceanic use, and will be extended for use in continental airspace for the provision of advanced DLS (referred to as ATN B1 and B2), as well as advanced Airline Operational Communications (AOC), using ATN/OSI protocols.

In simple terms, Iris will provide air-ground communications for initial '4D' flight path control, and as such will pinpoint an aircraft along four dimensions: latitude, longitude, altitude and time. This precise tracking of flights will allow pilots and controllers to collaborate on flight trajectories and calculate the shortest available routes, cruise at optimum altitudes, and use continuous climb and descent paths, saving fuel and improving the environment. Also, the Iris solution is expected to protect aircraft communications from cyber threats with secure gateways.

Iris is part of a much broader push to modernise how air traffic is managed in close collaboration with the SESAR Joint Undertaking launched in 2006 by EUROCONTROL and the EU. The new communication system will be standardised by the European Organisation for Civil Aviation Equipment (EUROCAE) and the International Civil Aviation Organisation (ICAO).

It has been set up with the ambition of providing an integrated DLS system-of-systems to meet current and future performance, safety, and capacity requirements that will become more stringent in line with increases in air traffic and data-hungry services⁶⁴.

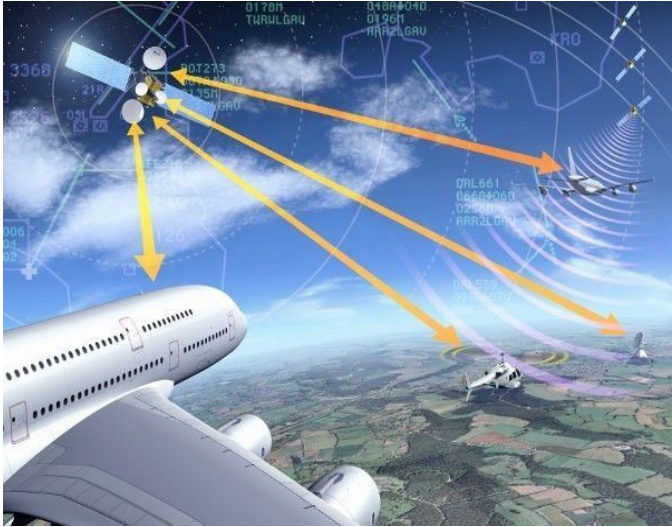

IRIS is an ESA programme to develop satellite-based

Currently, aircraft are tracked by radar when over land and in coastal areas, and pilots communicate with Air Traffic Control (ATC) by voice, over radio frequency. These channels are congested, and with the projected doubling of aircraft in Europe’s airspace by 2035, are expected to reach capacity within the next decade⁶⁵.

Iris started in 2014 and has been implemented in various stages, as shown in the figure below⁶⁶. It is anticipated that Iris will be fully operational in 2028, at which point the data link will be the primary means of communications between controllers and cockpit crews⁶⁷.

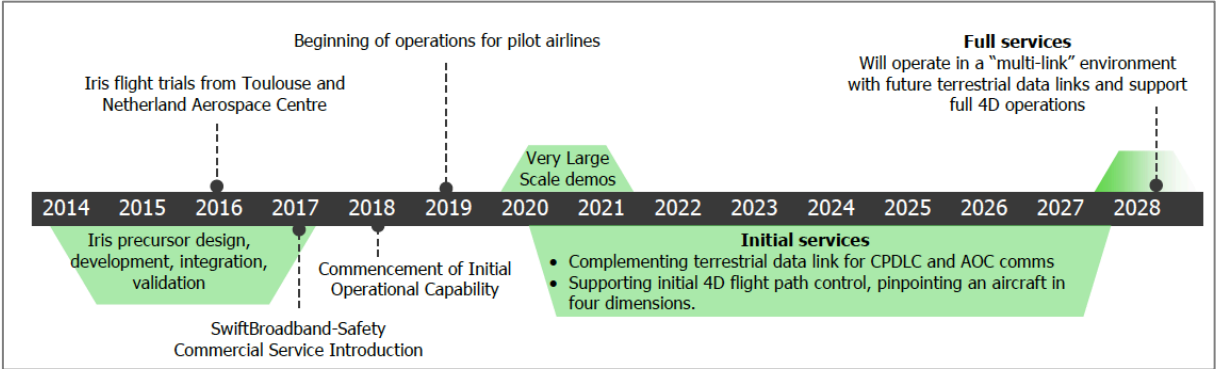

In terms of the benefits arising from participation in the PPP, Inmarsat lists three that are key. First, working with ESA allows the implementation of projects of a scale (budget) that would not be possible otherwise and allows for the de-risking of private investment.

Second, the set-up of the PPP allows it to incorporate companies operating in various sectors. The project is being undertaken in collaboration with a wider range of companies operating in the downstream and outside of the space sector. As an example, the development of the service has been done in partnership with key players from air traffic management, air transport, aeronautics and the satcom industry, including Airbus, Boeing, and Thales Alenia Space, together with the Iris programme’s first airline partner, Alitalia (Italy)⁶⁸. **Other UK partners CGI IT UK Ltd, Helios Technology,**

⁶⁴ https://artes.esa.int/sites/default/files/Iris_Documentation_2019.pdf
⁶⁵ http://www.esa.int/Our_Activities/Telecommunications_Integrated_Applications/Iris_for_aviation
⁶⁶ Inmarsat, ESA (2017) Iris, Delivering Air Traffic Modernization
⁶⁷ https://artes.esa.int/sites/default/files/Iris_Documentation_2019.pdf
⁶⁸ <https://www.inmarsat.com/press-release/inmarsat-european-space-agency-esa-enhance-air-traffic-management-europe-iris-service-evolution/>

Honeywell UK, NATS (En route) plc and SITA Information Network Computing UK Ltd. Honeywell, for instance, is providing the terminal equipment (antennas) needed in the aircrafts. This could lead to substantial commercial opportunities, as every plane wanting to use the system will have to carry the appropriate equipment in their cockpits.

Additionally, ESA has strong links with the relevant regulatory bodies and EU institutions (SESAR, EC) that are in charge of setting up the frameworks under which this new standard will operate. Technical knowledge and support provided by ESA is valuable, mostly around the quality of standards.

In terms of **commercial benefits** to Inmarsat (and other UK companies), it is too early to make those estimations as the system will be fully operational in 2028⁶⁹.

In terms of **wider benefits**, Inmarsat identifies benefits to airlines and to passengers⁷⁰. For airlines, benefits will materialise in terms of fuel savings and increased airspace and airport capacity (due to better route optimisation). Furthermore, there are economic benefits that would arise from passengers' access to onboard broadband and the consequent incremental revenue from broadband-enabled cabins.

A recent study from the London School of Economics and Political Science (LSE)⁷¹ estimates that broadband-enabled ancillary revenue will reach an estimated \$30 billion for airlines by 2035. The four primary areas of broadband enabled ancillary revenue (as defined in the LSE study) include (1) Broadband access, (2) Advertising, encompassing interruptive advertising and pay-per-click, (3) E-commerce and destination shopping and (4) Streaming, including premium content.

In Europe, that incremental revenue is estimated to be of around \$8.2 million by 2035. BA in the UK accounts for 17%⁷² of the passenger traffic in the Europe, **which means that the benefits to the UK could be in the order of \$1.4million by 2035 by concept of broadband-enabled ancillary revenue**. It is of course not possible to directly link those potential gains to Iris; however, it would be safe to say that Iris will enable European airlines tapping into those economic gains.

Additionally, Iris is expected to bring three main benefits to passengers (in the UK and Europe)⁷³:

- Reduced delays: better communications will allow more flights departing and landing on time, your waiting time at the airport and on the runway will be minimised.
- Reduced flight times: satellite connectivity has allowed planes flying oceanic routes to file and fly individually tailored flight plans, resulting in significantly shorter flight times. Bringing advanced satcom-enabled cockpit capabilities to narrow-body planes through Iris over Europe will bring the same benefits to continental flights.
- More environmentally friendly: more direct and efficient flights (able to identify their exact locations for landing) will reduce fuel use and consequently will reduce the carbon footprint for European aviation and travellers.

Interview details:

- Interview with Dale Irish, Head of aviation product management, Inmarsat.

⁶⁹ There is also a potential threat. ICAO and companies like Airbus (in the US) favour the implementation of Internet Protocol for Air Traffic Service (ATS) applications and other safety services, given its status de facto communications standard (as opposed to the ATN/OSI protocols in which Iris is based). However, that could take another 10 years to be fully operational (for air traffic). Additionally, US does not have the traffic congestion or the network density that Europe, which means that the latter operates in a more restricted environment. As such, ATN/OSI could still provide ATM enhancements not available otherwise, at least for a period of time.

⁷⁰ Inmarsat, ESA (2017) Iris, Delivering Air Traffic Modernization

⁷¹ Grous, Alexander (2017) "Quantifying the commercial opportunities of passenger connectivity for the global airline industry". Sky High Economics, London School of Economics and Political Science. <http://www.lse.ac.uk/business-and-consultancy/consulting/consulting-reports/sky-high-economics>

⁷² Based on data International Civil Aviation Organisation (ICAO) published by the ONS (<https://www.gov.uk/government/statistical-data-sets/aviation-statistics-data-tables-avi#major-airports-and-airlines-worldwide-avi03>).

⁷³ Inmarsat, ESA (2017) Iris, Delivering Air Traffic Modernization

technopolis |group| United Kingdom
3 Pavilion Buildings
Brighton BN1 1EE
United Kingdom
T +44 1273 204320
E info@technopolis-group.com
www.technopolis-group.com