AAIB Bulletin

5/2018

***TO REPORT AN ACCIDENT OR INCIDENT
PLEASE CALL OUR 24 HOUR REPORTING LINE***

01252 512299

Air Accidents Investigation Branch
Farnborough House
Berkshire Copse Road
Aldershot
Hants GU11 2HH

Tel: 01252 510300
Fax: 01252 376999
Press enquiries: 0207 944 3118/4292
<http://www.aaib.gov.uk>

AAIB investigations are conducted in accordance with Annex 13 to the ICAO Convention on International Civil Aviation, EU Regulation No 996/2010 and The Civil Aviation (Investigation of Air Accidents and Incidents) Regulations 2018.

The sole objective of the investigation of an accident or incident under these Regulations is the prevention of future accidents and incidents. It is not the purpose of such an investigation to apportion blame or liability.

Accordingly, it is inappropriate that AAIB reports should be used to assign fault or blame or determine liability, since neither the investigation nor the reporting process has been undertaken for that purpose.

AAIB Bulletins and Reports are available on the Internet
<http://www.aaib.gov.uk>

This bulletin contains facts which have been determined up to the time of compilation.

Extracts may be published without specific permission providing that the source is duly acknowledged, the material is reproduced accurately and it is not used in a derogatory manner or in a misleading context.

Published 10 May 2018

Cover picture courtesy of Stephen R Lynn
(www.srllynphotography.co.uk)

© Crown copyright 2018

ISSN 0309-4278

Published by the Air Accidents Investigation Branch, Department for Transport
Printed in the UK on paper containing at least 75% recycled fibre

CONTENTS**SPECIAL BULLETINS / INTERIM REPORTS**

None

SUMMARIES OF AIRCRAFT ACCIDENT ('FORMAL') REPORTS

None

AAIB FIELD INVESTIGATIONS**COMMERCIAL AIR TRANSPORT****FIXED WING**

Boeing 737-8AS	EI-EBW	14-Jan-17	3
----------------	--------	-----------	---

ROTORCRAFT

None

GENERAL AVIATION**FIXED WING**

Piper PA-28R-201 Cherokee Arrow III	G-CEOF	25-May-17	16
-------------------------------------	--------	-----------	----

ROTORCRAFT

None

SPORT AVIATION / BALLOONS

Silence Twister	G-JINX	14-May-17	36
-----------------	--------	-----------	----

AAIB CORRESPONDENCE INVESTIGATIONS**COMMERCIAL AIR TRANSPORT**

ATR 72-212A	EI-REM	18-Dec-17	59
-------------	--------	-----------	----

GENERAL AVIATION

Cessna 182T Skylane	G-LANS	09-Dec-17	61
Piper PA-28-140 Cherokee	G-ATPN	11-Feb-18	66
Piper PA-28-161 Cherokee Warrior II	G-BSXB	16-Nov-17	69
Piper PA-28-161 Cherokee Warrior III	G-WARY	16-Feb-18	73
Piper PA-28-181 Cherokee Archer II	G-BSIZ	07-Jan-18	76
Rotorway Executive 162F	G-CCMU	26-Oct-17	78

SPORT AVIATION / BALLOONS

Dynamic WT9 UK	G-RMHE	04-Feb-18	80
Ikarus C42 FB100 Bravo	G-OSPH	16-Feb-18	81
Jabiru UL-450	G-JAXS	05-Feb-18	82
Pegasus Quik GT450	G-PUGZ	17-Feb-18	84
Rans S6-ES Coyote II	G-BYSN	08-Oct-17	86

CONTENTS Cont

AAIB CORRESPONDENCE INVESTIGATIONS Cont

UNMANNED AIRCRAFT SYSTEMS

None

MISCELLANEOUS

ADDENDA and CORRECTIONS

None

List of recent aircraft accident reports issued by the AAIB 89
(ALL TIMES IN THIS BULLETIN ARE UTC)

AAIB Field Investigation Reports

A Field Investigation is an independent investigation in which AAIB investigators collect, record and analyse evidence.

The process may include, attending the scene of the accident or serious incident; interviewing witnesses; reviewing documents, procedures and practices; examining aircraft wreckage or components; and analysing recorded data.

The investigation, which can take a number of months to complete, will conclude with a published report.

ACCIDENT

Aircraft Type and Registration:	Boeing 737-8AS, EI-EBW
No & Type of Engines:	2 CFM International CFM56-7B/3 turbofan engines
Year of Manufacture:	2009
Date & Time (UTC):	14 January 2017 at 1645 hrs
Location:	On descent to Manchester Airport
Type of Flight:	Commercial Air Transport (Passenger)
Persons on Board:	Crew - 6 Passengers - 89
Injuries:	Crew - 1 (Serious) Passengers - None
Nature of Damage:	None reported
Commander's Licence:	Airline Transport Pilot's Licence
Commander's Age:	31 years
Commander's Flying Experience:	4,977 hours (of which 4,833 were on type) Last 90 days - 156 hours Last 28 days - 29 hours
Information Source:	AAIB Field Investigation

Synopsis

Whilst descending in to a high altitude jetstream, an associated rise in headwind caused the aircraft to overspeed. The commander disengaged the autopilot (AP) and used manual control inputs to stop the speed increasing, but in doing so applied a significant nose-up pitch input on the control column. The resulting manoeuvre caused two cabin crew members to fall, and one of them sustained a broken ankle. The operator has issued additional guidance to its pilots regarding overspeed recognition and recovery.

History of the flight

At FL 400, in the London terminal control area, the crew requested descent clearance from ATC to coincide with the top of descent point which had been calculated by the aircraft's flight management computer (FMC). The aircraft was heading in a north-westerly direction.

The pilots were aware the aircraft might encounter a forecast northerly jetstream during the descent.

The commander, who was PF, stated to the operator that the margin below the aircraft's maximum operating Mach number (M_{MO}) was small due to the aircraft's high altitude¹.

Footnote

¹ At high altitudes, the margin between the indicated minimum and maximum speed is less than at lower altitude.

ATC issued the crew with a descent clearance to FL200 and requested that they fly at 270 kt on speed conversion², which was higher than the operator's default conversion speed of 245 kt³. The aircraft then initiated its descent on the intended descent path at 0.77-0.78 Mach and with 109 nm to touchdown.

The autopilot and autothrottle were engaged, with the autopilot coupled to the PF's flight guidance, in accordance with standard operating procedure. The aircraft's flight path was controlled by LNAV⁴ and VNAV PATH⁵ autopilot modes, and the FMC ECON⁶ speed schedule.

No turbulence was present and the passenger seatbelt signs were off.

Recorded data showed that from FL392 in the descent, the windspeed displayed on the primary flight display (PFD) started to rise gradually. Then, when passing FL367, it increased at a greater rate, rising by 22 kt over 28 s. This corresponded with an increase in the aircraft's speed from 0.78 M to a maximum of 0.818 M, where an overspeed was recorded. The commander recalled that the speed trend vector⁷ had simultaneously extended rapidly well into the overspeed warning zone⁸ by around a corresponding 15-20 kt.

The commander reported that because the autopilot appeared not to be correcting the condition, and thinking that he had little time to react, he simultaneously pressed the autopilot disengage button on his control wheel and pulled back on the control column. His intention was to avoid the overspeed as smoothly as possible using manual control inputs.

The following parameters were recorded.

There were marked changes in normal acceleration⁹ on the aircraft over a short period.

Further analysis of the data by the manufacturer showed that in the one second during which the autopilot became disengaged the force exerted on the control column by the commander changed from -0.51 lbs to +42.76 lbs.

Immediately following autopilot disengagement, the overspeed protection logic caused the vertical flight mode to revert from VNAV PATH to LEVEL CHANGE¹⁰.

Footnote

- ² Speed control to apply following the point at which the indicated aircraft speed changes from Mach to IAS in the descent.
- ³ The operator's default conversion speed is pre-programmed into each aircraft's FMC, and can be manually changed if necessary.
- ⁴ LNAV – a flight director mode which couples the aircraft's lateral navigation to the route programmed in the FMC.
- ⁵ VNAV PATH – a flight director mode which couples the aircraft's vertical navigation to the profile programmed in the FMC.
- ⁶ ECON – an FMC mode which controls the aircraft's speed according to pre-programmed economic and aircraft performance parameters.
- ⁷ Speed trend vector – an arrow on the airspeed indicator, the tip of which predicts the airspeed in the next 10 s based on current airspeed and acceleration.
- ⁸ The striped portion of the airspeed indicator which extends upwards from the maximum operating airspeed or Mach number.
- ⁹ Normal acceleration – The component of the linear acceleration of an aircraft along its normal or vertical axis.
- ¹⁰ Level change – a flight director mode that adjusts the aircraft's pitch to maintain a selected airspeed during climb or descent.

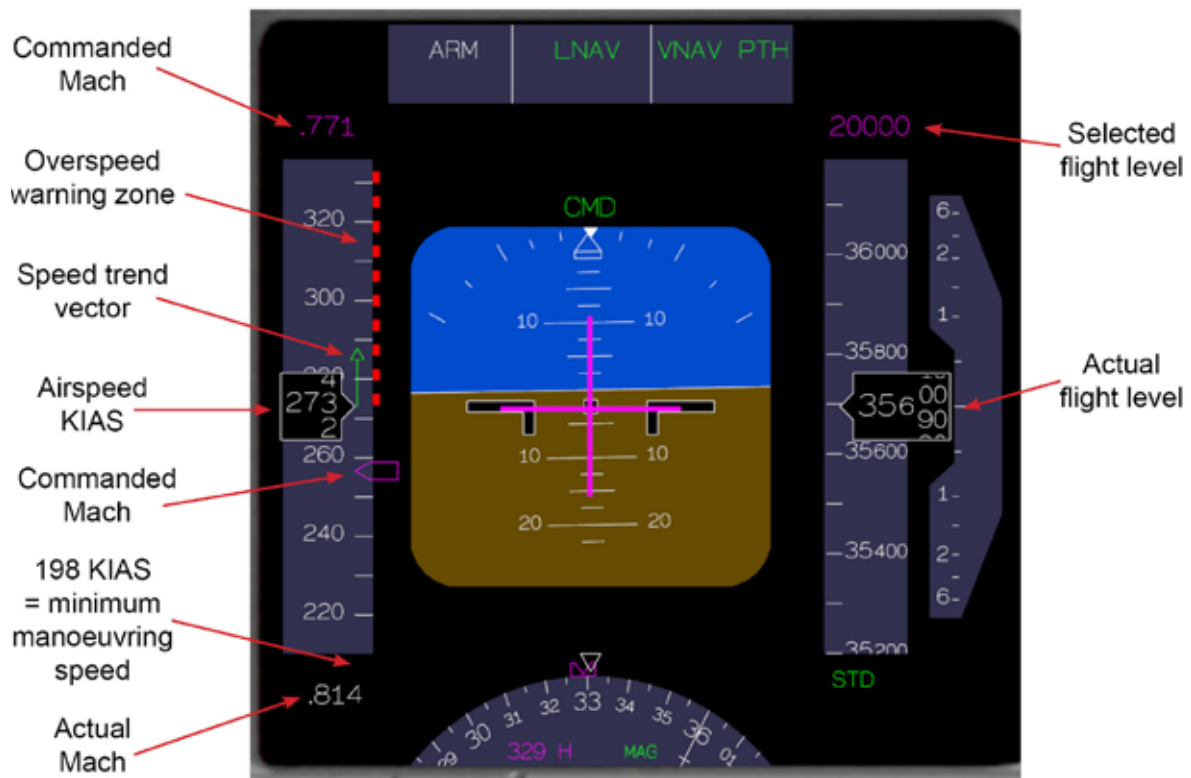

Figure 1

Example image of a PFD under conditions similar to EI-EBW just prior to autopilot disengagement

During the event, two cabin crew standing in the rear galley fell to the floor. One sustained a fractured ankle. All passengers were seated throughout.

The co-pilot reported to the operator after the event that, when the autopilot disengaged, he cancelled the aural alert and followed through with the control column inputs being made.

The commander stated that he had not noticed the windspeed indication on the PFD increasing. Both pilots reported to the operator that they noted and discussed the ensuing airspeed increase.

The commander reported that he was aware of the possibility of encountering a jetstream in the descent, but had not seen the airspeed increase to this extent before. He perceived that there was startle effect¹¹ in his response due to both the rate of the airspeed increase towards M_{MO} , and by the magnitude of the impending overspeed indicated by the speed trend vector. At the time, he believed he was managing the manoeuvre gently but with hindsight he suspected that startle effect caused him to exert more force on the control column than intended.

Footnote

¹¹ 'Startle effect' – a reflex action elicited by exposure to a sudden, intense event that violates a pilot's expectations.

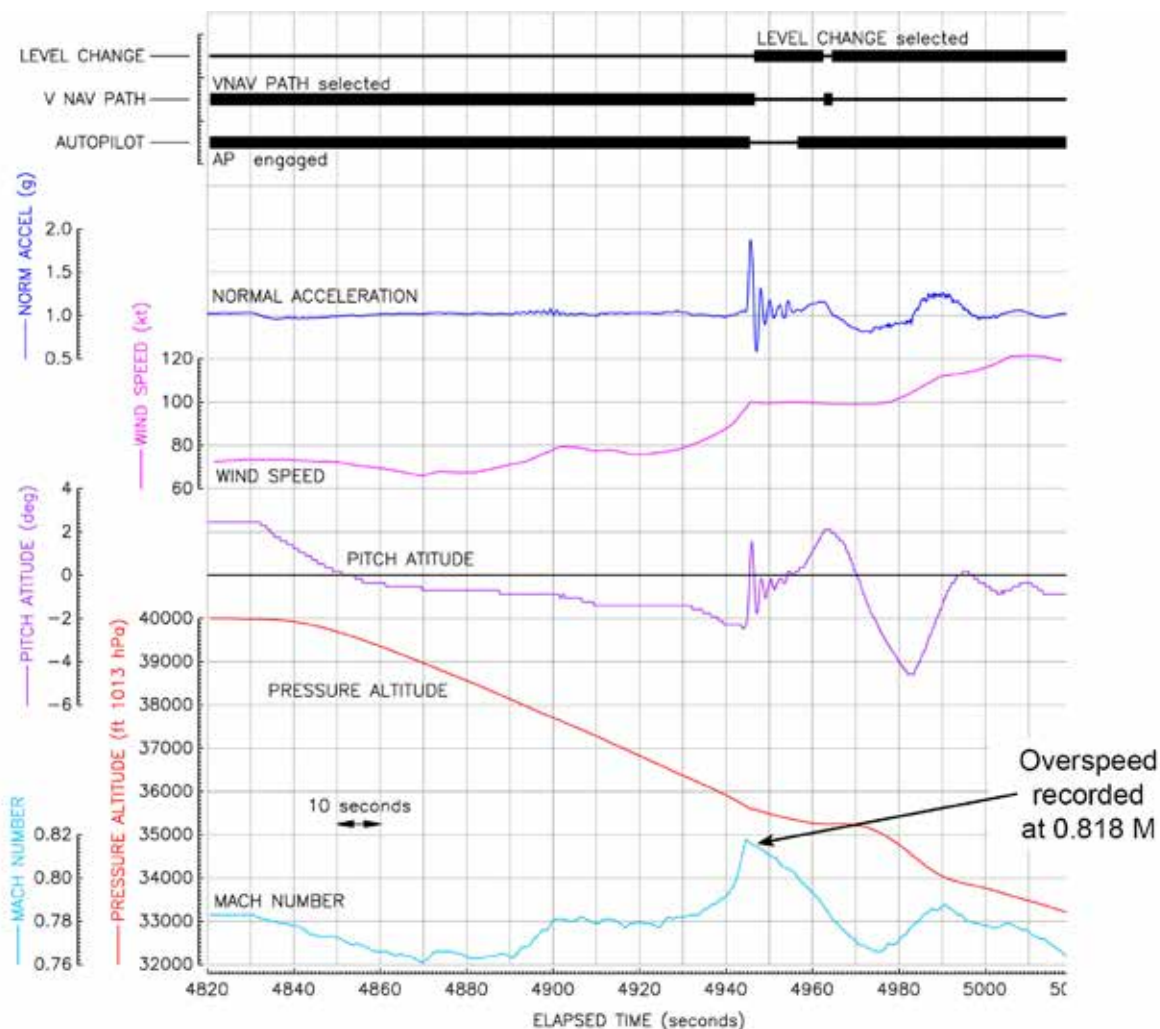

Figure 2
Recorded information

Operating procedures

Descent planning

The pilots planned the aircraft's descent according to standard operating procedures.

The operator's Operations Manual Part A covers '*Pre-descent considerations*', and states:

'The top-of-descent point shall be determined taking into account the standard descent distance adjusted for wind component, anticipated ATC routing and possible holding, icing, safety heights, and runway in use. This is computed by the FMC based on routing and constraints entered.'

'The descent will be conducted in such a way as to achieve fuel economy. This is best achieved by VNAV and ECON speed.'

The manufacturer's Flight Crew Operating Manual (FCOM) and Flight Crew Training Manual (FCTM) form part of the operator's standard operating procedures. The FCOM 'Descent and Approach Setup and Briefing' section states:

'Threat and Error Management is a dynamic process by which pilots identify threats and errors, and implement management strategies to maintain safety margins. It should not be seen as a "box-ticking" exercise at the beginning of briefings, but rather as a tool to prevent undesired aircraft states through effective management techniques. The pre-descent briefing shall use the acronym "DALTA" which stands for Descent, Approach, Land, Taxi and Apron.'

The section, 'Threats – Pilot Flying and Pilot Monitoring', states:

'Prior to commencing the DALTA process, crew shall anticipate and discuss the threats that could be associated with their departure and initial climb. Subsequently, crews should be in a constant state of anticipation as the descent, approach and landing phase progress. These typically might [include]... overspeed'

Overspeed procedures

The FCTM section on 'Overspeed' states:

'VMO¹²/MMO is the airplane maximum certified operating speed and should not be exceeded intentionally. However, crews can occasionally experience an inadvertent overspeed. Airplanes have been flight tested beyond VMO/MMO to ensure smooth pilot inputs will return the airplane safely to the normal flight envelope.

During cruise at high altitude, wind speed or direction changes may lead to overspeed events. Although autothrottle logic provides for more aggressive control of speed as the airplane approaches VMO or MMO, there are some conditions that are beyond the capability of the autothrottle system to prevent short term overspeeds.

When correcting an overspeed during cruise at high altitude... If autothrottle corrections are not satisfactory, deploy partial speedbrakes slowly until a noticeable reduction in airspeed is achieved. When the airspeed is below VMO/MMO, retract the speedbrakes at the same rate as they were deployed.

During descents at or near VMO/MMO, most overspeeds are encountered after the autopilot initiates capture of the VNAV path from above or during a level-off when the speedbrakes were required to maintain the path... During descents using speedbrake near VMO/MMO, delay retraction of the speedbrakes until after VNAV path or altitude capture is complete. Crews routinely climbing or descending in windshear conditions may wish to consider a 5 to 10 knot

Footnote

¹² V_{MO} – Maximum permitted operating airspeed.

reduction in climb or descent speeds to reduce overspeed occurrences. This will have a minimal effect on fuel consumption and total trip time.

When encountering an inadvertent overspeed condition, crews should leave the autopilot engaged unless it is apparent that the autopilot is not correcting the overspeed. However, if manual inputs are required, disengage the autopilot. Be aware that disengaging the autopilot to avoid or reduce the severity of an inadvertent overspeed may result in an abrupt pitch change

During climb and descent, if VNAV or LVL CHG pitch control is not correcting the overspeed satisfactorily, switching to the V/S¹³ mode temporarily may be helpful in controlling speed.'

The FCOM mentions another aspect of the autopilot's overspeed protection logic in the 'VNAV Descent and Approach Path' section:

'Note: When passing top of descent and using high target speeds (within approximately 6 knots of V_{mo}/M_{mo}), VNAV may revert to LVL CHG to prevent overspeed...'

In the case of EI-EBW, this mode reversion occurred just after the autopilot disengagement. Subsequently the flight director commanded a pitch-up to slow the aircraft.

The commander stated that at the time of the accident he was aware of the content of these overspeed procedures, and the automatic protections.

Aircraft information

Control column input

The aircraft's Flight Control Computer had been loaded with software version P8.0.

One of the effects of the P8.0 software update was a change in the autopilot's response to force override through the control column or wheel. Prior to the update, force override would result in an automatic transition to pitch and/or roll control wheel steering (CWS)¹⁴ mode when the autopilot was engaged or at the time of engagement. With installation of the P8.0 software, this method of transition to CWS mode was removed. The manufacturer's Service Letter 737-SL-22-065-A states:

'Application Program Changes: 1) For a column and/or wheel force override of single channel autopilot, in either the approach or non-approach modes, the autopilot will disconnect and set the standard autopilot disconnect warning while maintaining any active flight director pitch and roll modes...'

Footnote

¹³ Vertical speed mode – Flight director mode which controls the aircraft's vertical profile according to a manually set rate of climb or descent.

¹⁴ CWS mode allows the pilot to manoeuvre the aircraft using manual control column and wheel inputs whilst the autopilot remains engaged.

Therefore, on EI-EBW force override would result in the autopilot disconnecting.

The aircraft's control column is mechanically linked to the elevator actuators and, except for small effects involving cable stretch, any motion of the control column results in motion of the elevator actuators and elevators (see Figure 3). Three forces are applied to the mechanical linkage: the feel computer, the autopilot servos and pilot control column input. The sum of these three forces will determine the position of the mechanical linkage, and thus the inputs to the elevators.

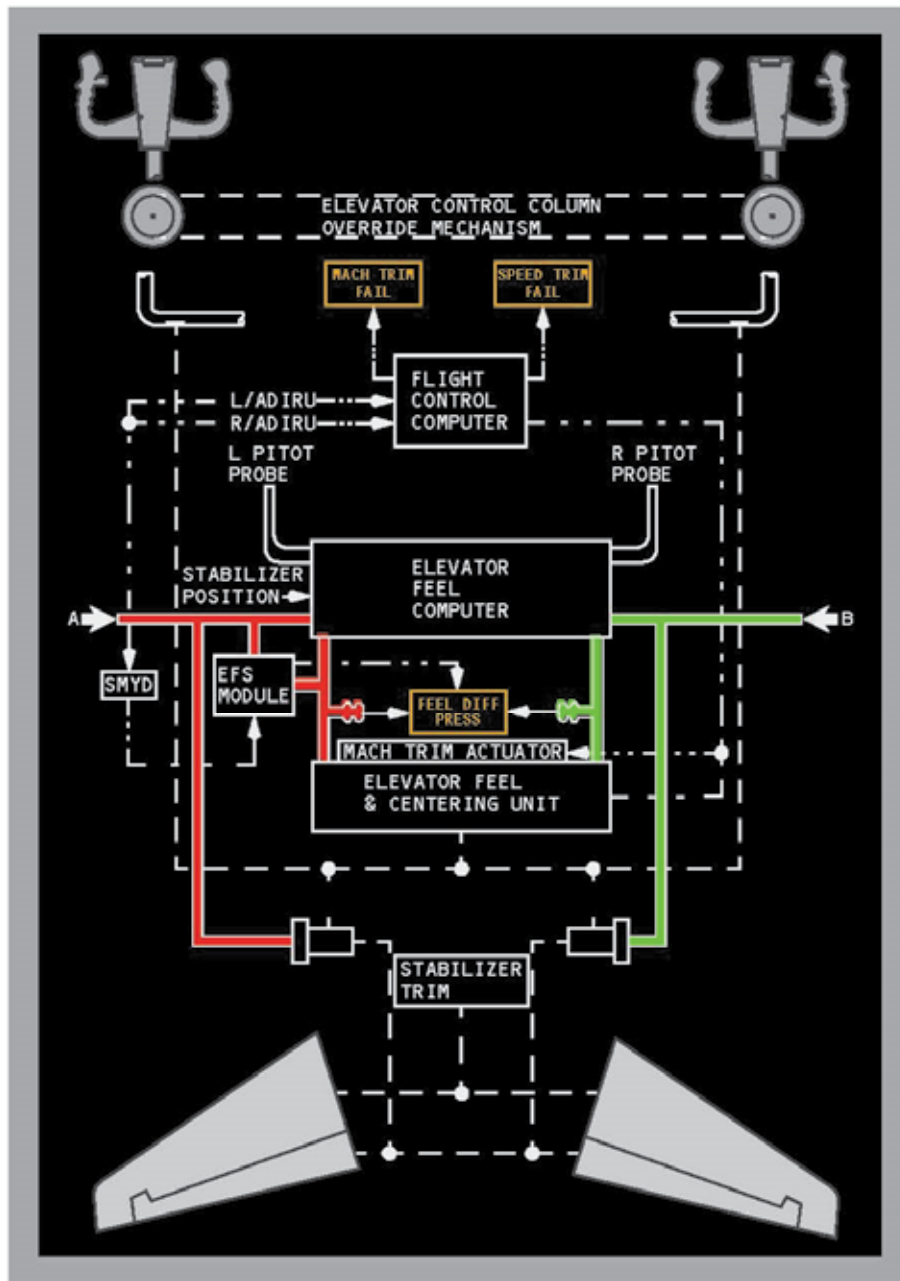

Boeing Proprietary. Copyright © Boeing. May be subject to export restrictions under EAR. See title page for details.

Figure 3

Pitch control system schematic

The feel computer behaves like a centering spring whose stiffness varies with airspeed. It provides a restoring force towards the neutral position of the control column. The autopilot servos are limited to 25 lb of force for single channel operation. Separate force sensors measure pilot column input and the autopilot will disconnect if the force applied by the pilot(s) exceeds 21 lbs.

To have any effect on elevator position with the autopilot engaged, the pilot input force must overcome the sum of the autopilot applied force and the feel computer.

If the autopilot acts to keep the control column in its neutral position, both the autopilot and the feel computer will be resisting any pilot input. In this case, the 21 lb manual input threshold will be reached before the autopilot actuator needs to exert an opposing 25 lb to maintain the column's neutral position, resulting in the autopilot disconnecting before there is any motion transmitted to the elevators.

Parameters relevant to autopilot disconnection for this accident were recorded. The sample rate was such that the timing of disconnection could be determined within a window of 0.3 s. The column force exerted by the commander rose above the autopilot disconnect threshold of 21 lb during such an interval of 0.3 s. Accordingly, it was not possible to determine whether autopilot disengagement was caused by force override or by the commander's use of the autopilot disengage button.

The manufacturer performed a simulation to ascertain how abrupt the pitch change would have been if the autopilot had been disengaged using the button only, without any control column input by the pilot. The simulated pitch rate was approximately 1.1° per second, whereas the pitch rate during the event on EI-EBW at disconnect was 4.6° per second.

High altitude aerodynamics

As an aircraft climbs, its flying characteristics change as the air density reduces. At higher altitudes, a given control movement results in a higher pitch rate, less aerodynamic damping¹⁵ and a higher angle of attack¹⁶. Furthermore, the margin between M_{MO} and the stall speed for a given load factor decreases with altitude. Accordingly, it is necessary to use careful handling at high flight levels.

Previously, at the request of the FAA, the NTSB had formed an industry working group¹⁷ to address high altitude loss of control accidents and incidents. The group produced a document entitled '*Airplane Upset Recovery – High Altitude Operations*' (Rev. 2, 2008).

'At altitudes where the operational envelope is reduced: Be alert... Do not use large control movements... Be smooth with pitch and power to correct speed deviations'

'The [high altitude] upset¹⁸ startle factor: When not properly avoided, managed or flown – assures a self-induced upset'

Footnote

¹⁵ The restoring moment created by the changed relative airflow in response to manoeuvres of the aircraft around its centre of gravity.

¹⁶ Angle at which relative airflow meets an aerofoil.

¹⁷ The Airplane Upset Recovery Training Aid Team.

¹⁸ Aircraft upset – Sudden and undesirable disturbance to flight path.

Weight and balance

The load sheet for the flight showed the aircraft's weight and balance to be within the specified limits.

Meteorology

A Met Office aftercast showed that the actual weather around the time of the accident approximately matched that forecast at the time the crew would have been performing their pre-flight preparations.

The aftercast showed that an area of high pressure was centred to the southwest of the UK, causing a northerly airflow. Some moderate turbulence was present between FL220 and FL380 due to a 100 kt jetstream aligned north to south over the UK. Satellite imagery showed that the sky was clear of cloud. No significant meteorological information reports (SIGMETs)¹⁹ had been issued in the London FIR that day, suggesting that there had been no aircraft reports of severe turbulence.

The weather for Manchester Airport between 1620 and 1720 hrs was reported as: surface wind of 7-9 kt from 300°; visibility 10 km or more; no cloud; temperature 6°C; and QNH 1021 hPa.

The following table shows the forecast winds for the descent which were annotated on the Operational Flight Plan provided to the pilots, along with the actual wind speeds recorded by the aircraft. The latter are rounded to the nearest thousand feet.

Flight Level	Forecasted wind direction/ velocity	Recorded wind speed ¹ (kt)
FL400	348/062	073
FL390	347/068	067
FL380	349/073	070
FL370	Not available	076
FL360	353/084	082
FL350	356/094	098
FL320	Not available	118
FL310	359/112	Not available
FL200	350/081	Not available

Note:

- ¹ The wind direction was not available from the data, however, aftercast weather information shows that the upper winds were from a similar direction to that forecast.

Footnote

- ¹⁹ SIGMET – a weather advisory that contains meteorological information concerning the safety of all aircraft.
-

Personnel

The commander had an EASA ATPL. At the time of the accident he had 4,997 total flight hours, of which 4,833 hours were on type.

The co-pilot had an EASA ATPL. His total hours at the time of the accident were 2,984 hours, of which 2,833 hours were on type.

Training

The commander completed his type rating with the operator in 2010, the co-pilot in 2012.

Training records indicated that throughout their employment the operator considered both pilots' simulator performance as satisfactory, with the commander achieving mostly grades 3 ('good') and 2 ('very good').

The records indicated that both pilots completed the following training prior to the accident unless otherwise stated.

High altitude operations

Mach buffet²⁰ training was included in both pilots' type rating courses.

The recurrent simulator session (RST) during 2014 and 2015, covered high altitude operations. Its associated presentation explained the reduced speed margins at higher flight levels, g load awareness, and outlined the actions to take in the event of an overspeed, as follows:

'Ideally, leave autopilot engaged; If autothrottle response is unsatisfactory, deploy partial speedbrakes slowly; Once speed is less than Vmo/Mmo, retract speedbrakes at the same rate of deployment.'

Instructors were asked to inform crew of another operator's accident²¹ in which a cabin crew member was seriously injured when the pilots took manual control. The guidance notes explained:

'There are increased risks associated with manual flight input during high altitude operations; on this [EI-CVA] occasion "An abrupt manual pitch input resulted in higher than usual g forces being experienced by the Cabin Crew Members".'

Since the accident both pilots have undergone an RST which included g awareness. The pre-simulator study guide stated:

Footnote

²⁰ When an aircraft exceeds its critical Mach number and enters the transonic speed range, airframe buffet can occur.

²¹ Air Accident Investigation Unit Ireland report on Airbus A320-214, EI-CVA – Autopilot disconnection and a manual flight control input at high level caused a cabin crew member to fall and sustain a broken ankle.

'[At] high altitude [and] high Mach number/TAS, even small column deflections can induce significant G loading on the aircraft. [At] low altitude [and] lower Mach number/TAS, the aircraft is not as sensitive to control column inputs, and will not generate the higher G loads for the same control deflections.'

Flight path management

The pilots type rating courses included: acceleration to and deceleration from V_{MO}/M_{MO} ; auto flight director system (AFDS) speed limiting and reversion modes; and 'VNAV speed training.' Each pilot certified that they had watched "Jet upset and recovery" training videos.

The RST in 2012 and 2013, included fundamental aerodynamics for large aircraft, and energy management²² training. The co-pilot did not undertake this session because he was completing his initial type rating.

In 2014, use of the AFDS was discussed. The pre-simulator study notes stated:

'Responsibility for flight path management remains with the pilots at all times... pilots should remember; first and foremost – fly the aeroplane. At any time, if the aircraft does not follow the desired airspeed or vertical or lateral profile do not hesitate to change to a lower level of automation...'

In 2015 and 2016, pilots practiced raw data manual handling. The associated presentation discussed energy management and automation²³ management, and reviewed the autothrottle overspeed protection at V_{MO} .

The pre-simulator study guide states:

'More specifically the training will focus on the following: smooth and accurate aircraft control, appropriate to the situation; detecting deviations from the desired aircraft trajectory and taking appropriate action; keeping the aircraft within the normal flight envelope; controlling the aircraft safely using the relationship between aircraft attitude, speed and thrust; maintaining the desired flight path while managing other tasks and distractions'

Since the accident, both pilots have completed an RST which focussed on overspeed recovery. It demonstrated autothrottle overspeed protection at V_{MO} , recovery from an overspeed using speedbrake and AFDS reversion to LVL CHG in conditions of impending overspeed.

Footnote

²² The monitoring and control of an aircraft's kinetic and potential energies to mitigate hazards caused by unsafe or degrading energy states.

²³ Automation – control systems and information technologies that reduce the need for human intervention.

Related occurrence

In March 2017 a Boeing 737 encountered an increasing headwind during descent which resulted in indications that the aircraft would overspeed²⁴. The pilot flying responded using a manual control input which caused the autopilot to disengage. Two cabin crewmembers suffered injuries during the resulting aircraft manoeuvre.

The aircraft manufacturer has indicated that it is aware of other similar occurrences.

Analysis

The FCTM highlights that the primary response to an aircraft overspeed is to use the speed brake, and that the autothrottle logic provides some overspeed protection through more aggressive speed control as the aircraft approaches V_{MO}/M_{MO} . The effects of this autothrottle logic had been demonstrated in the simulator to both pilots. The FCOM mentions that further overspeed protection is offered by the vertical mode transitioning from VNAV PATH to LVL CHG in conditions of impending overspeed.

The FCTM overspeed procedure also states:

'pilots should leave the AP engaged unless it is apparent that it is not correcting the overspeed. However, if manual inputs are required, disengage the autopilot'.

The aircraft's speed rose from 0.78 M to almost 0.82 M in 28 s. If the commander only realised the severity of the impending overspeed just before it occurred – and believed that the autopilot was not correcting the condition – then he may have felt compelled to disengage the autopilot, as described in the procedure.

Pilots are reminded during training that they must not hesitate to use a lower level of automation if required to maintain the aircraft's flight path.

When taking manual recovery action at high altitude it is important to consider the need for careful handling. Whilst an overspeed is undesirable, there is typically a large margin between the onset of the overspeed warning and any undesired aerodynamic characteristics. Hence, there is often less risk in exceeding V_{MO}/M_{MO} slightly than there is in manual manoeuvring.

In this instance, the pilot considered that he was startled by the increasing speed and magnitude of the trend indication. Whilst he believed at the time that he was manoeuvring gently, the resulting overriding force on the control column was 42.76 lb – approximately double that required to disconnect the autopilot – and was large enough to cause a manoeuvre sufficient to unbalance the two cabin crew and for one to suffer a serious injury.

As well as recovery techniques for a high altitude overspeed event, some preventative measures exist, such as flying at a lower altitude, descending early, and slowing down when

Footnote

²⁴ Report of the Australian Transport Safety Bureau regarding VH-VZZ: https://www.atsb.gov.au/publications/investigation_reports/2017/air/ao-2017-030/

able do so – if necessary declining ATC requests to fly a higher speed. These activities, requiring active monitoring, may also reduce the risk of startle.

The commander commented that he learned from this experience, particularly in relation to managing the reduced operational margins and handling sensitivities of the aircraft at high altitudes.

Conclusion

The serious injuries suffered by a cabin crew member occurred because significant manual control inputs were applied in response to an impending overspeed, which resulted in the aircraft manoeuvring abruptly. An increasing headwind associated with a jetstream had caused the airspeed to rise. The narrow speed margins and handling sensitivities of the aircraft at high altitudes were contributory factors.

Safety action

After this event, the operator released a memo to all pilots entitled '*Overspeed (Impending/Actual) Recognition and Recovery*', dated 3 May 2017. This document reiterates the manufacturers FCTM guidance on overspeed, and provides supplementary guidance for use of the mode control panel (MCP)²⁵, speed brake, autothrottle and autopilot in an overspeed condition. It states:

'...this guidance applies to all phases of flight. Crew, however, must recognize the difference between correcting an overspeed in level flight and correcting an overspeed when climbing or descending. Furthermore, when attempting to correct an overspeed condition, crew must also recognize the additional challenges associated with disengagement of (1) the auto throttle and (2) the autopilot.'

The memo also provides guidance for use of the MCP, speed brake, autothrottle and autopilot during the different phases of flight, in relation to overspeed recovery.

In relation to descent it states:

'Autopilot: Monitor. Disengage ONLY if [the] autopilot [is] exacerbating the overspeed, or if required due to severe turbulence'

The aircraft manufacturer stated that it is considering a revision to the overspeed guidance in the 737 Flight Crew Training Manual to state more explicitly that the preferred response to impending overspeed at high altitude is to leave the autopilot engaged and instead deploy partial speedbrakes slowly.

Footnote

²⁵ Mode control panel – Instrument panel for controlling the AFDS.

ACCIDENT

Aircraft Type and Registration:	Piper PA-28R-201 Cherokee Arrow III, G-CEOF	
No & Type of Engines:	1 Lycoming IO-360-C1C6 piston engine	
Year of Manufacture:	1988 (Serial no: 2837008)	
Date & Time (UTC):	25 May 2017 at 1050 hrs	
Location:	Two miles north-east of Skipness, Kintyre peninsula	
Type of Flight:	Private	
Persons on Board:	Crew - 1	Passengers - 1
Injuries:	Crew - 1 (Fatal)	Passengers - 1 (Fatal)
Nature of Damage:	Aircraft destroyed	
Commander's Licence:	Private Pilot's Licence	
Commander's Age:	62	
Commander's Flying Experience:	Approximately 219 hours (of which 38 were on type) Last 90 days - 8 hours Last 28 days - 5 hours	
Information Source:	AAIB Field Investigation	

Synopsis

During a flight from Oban to Carlisle, the aircraft flew into an area of low cloud, fog and mist that extended from the Irish Sea, around the Isle of Arran and into Loch Fyne. As the aircraft travelled down Loch Fyne it descended into the sea, approximately two miles north-east of Skipness on the Kintyre peninsula. The pilot and passenger were fatally injured in the accident.

History of the flight

The pilot chartered the aircraft from Carlisle Lake District Airport on 20 May 2017 to fly to Oban Airport where he planned to meet friends and walk up Ben Nevis. The intention was to return to Carlisle on 24 May 2017. After a brief flight check with a local instructor, the pilot and a friend departed Carlisle at 1600 hrs for the flight to Oban. Oban Airport closed at 1715 hrs and although the flying club at Carlisle had attempted to arrange for an out-of-hours arrival before his departure, the paperwork had not been correctly submitted. Consequently, en route to Oban the pilot was informed by Scottish Information that Oban Airport would be closed at his predicted arrival time and he was advised to divert to Cumbernauld Airport. The pilot landed at Cumbernauld at 1638 hrs.

The following morning the pilot had a discussion with instructors at Cumbernauld on the routing to Oban. G-CEOF departed Cumbernauld at 1151 hrs and arrived at Oban at

1246 hrs on 21 May 2017¹. The weather on 24 May 2017 was not suitable for the planned return flight to Carlisle, so the flight was delayed until 25 May 2017.

The pilot and passenger arrived at Oban Airport at approximately 0900 hrs on 25 May 2017. There was fog and low cloud in the area at that time and the conditions were not suitable to depart Oban and fly to Carlisle. The pilot was seen by several witnesses checking the weather using an application on a mobile device; however, it was not possible to confirm which application he used. At some point, the pilot contacted the flying school at Carlisle and was told that the weather at the airfield was poor but was expected to improve. The pilot discussed the weather with the Flight Information Service Officer (FISO) at Oban and mentioned that there was low cloud at Campbeltown and Islay, and that he would delay his departure. At approximately 0950 hrs, the pilot contacted the flying school at Carlisle and was informed that the weather had improved at the airfield. He told them that he would depart Oban shortly and asked the school to book a taxi to meet the aircraft to take him and his passenger to Carlisle train station. Several witnesses stated that the pilot told them that he intended to head to Campbeltown; one witness said that the pilot told him that he would route closer to Prestwick. The departure at 1025 hrs was uneventful and the aircraft changed frequency to Scottish Information shortly after leaving the ATZ.

At 1040 hrs, the pilot of G-CEOF relayed a message to Scottish Information, via a second aircraft, that he was over Lochgilphead at 1,000 ft and that he was routing to Carlisle via the Turnberry VOR. Scottish Information, in turn, relayed a message informing the pilot of G-CEOF that he would receive a Basic Service and to squawk 7401. He was also advised that better two-way communication could be expected as the aircraft routed south towards the Turnberry VOR. The flight details were passed to Prestwick ATC as Scottish Information anticipated transferring the aircraft to Prestwick once it was in the vicinity of Bute.

Approximately 20 minutes after the relay call to G-CEOF, Scottish Information had still not heard from the pilot of G-CEOF and therefore the FISO attempted to communicate with him. As there was no response from the pilot, and the FISO could see no evidence of the aircraft on his Flight Information Display, he checked with ATC at Prestwick, Glasgow, Campbeltown, Oban and Carlisle to determine if any of these units were in contact with the aircraft. As none of these units had made contact with the pilot, at 1115 hrs the FISO at Scottish Information reported his concern for the safety of the aircraft to the Airways Watch Manager and the Distress and Diversion (D&D) Cell at Swanwick. Floating wreckage and the bodies of both occupants were later recovered from the sea.

Aircraft information

The Piper 28R-201 is a four-seat, low wing monoplane of all metal construction, with retractable landing gear and conventional controls.

G-CEOF was powered by a fuel injected piston engine fitted with a three-blade, constant-speed propeller and when cruising at 120 kt used approximately 40 litres of fuel

Footnote

¹ The arrival date was incorrectly logged by Oban ATC as 22 May 2017.

per hour. Fuel was stored in two wing tanks with a total useable capacity of 38 gal US (146 litre) in each. A three-position rotary fuel selector valve situated on the left cockpit wall, allowed the pilot to select the LEFT or RIGHT fuel tanks, or both tanks OFF. A fuel contents gauge for each tank was situated on the lower part of the instrument panel. In addition to the mechanical fuel pump on the engine, the aircraft was also fitted with an electric fuel booster pump that could be selected ON / OFF by the pilot. A fuel flow gauge was fitted and co-located with a manifold pressure gauge, adjacent to the engine rpm gauge.

G-CEOF was approved to operate in IMC conditions and was fitted with a Mode C capable transponder that transmitted the aircraft's altitude to an accuracy of ± 50 ft. It had two altimeters and the attitude indicator was driven by suction provided by a mechanical pump fitted to the aircraft's engine.

The front seat occupants were secured by a lap and diagonal seatbelt. There were no lifejackets or a life raft on the aircraft during the accident flight.

Maintenance

G-CEOF was operated on a Certificate of Airworthiness and maintained to the Light Aircraft Maintenance Programme (CAP 766). The annual maintenance was completed on 1 September 2016 at 11,377 Flight Hours and the last maintenance activity, a six month / 50-hour check was completed on 7 March 2017 at 11,396 Flight Hours. The Airworthiness Review Certificate was issued on 1 July 2016 at 11,376 Flight Hours and was valid until 3 July 2017.

No significant faults had been recorded in the aircraft documentation. An instructor who flew G-CEOF regularly, and who undertook the check flight with the pilot on the day he departed for Oban, reported that all the equipment on the aircraft operated satisfactorily and when the pilot demonstrated a recovery from a stall, the stall warner operated correctly.

Search and Rescue organisation

Distress and Diversion Cell

The Distress and Diversion (D&D) Cell is a Royal Air Force Unit based at the London Area Control Centre in Swanwick. The unit undertakes a number of tasks including assistance to aircraft in an emergency and carrying out tracing action for missing / lost aircraft.

Aeronautical Rescue and Coordination Centre

The Aeronautical Rescue and Coordination Centre (ARCC) is based at the National Maritime Operations Centre (NMOC). The ARCC² is responsible for coordinating all Maritime and Coastguard Agency Search and Rescue (SAR) helicopters and for providing an aeronautical SAR service in conjunction with the D&D Cell.

Footnote

² Responsibilities are detailed in MCA; ARCC Transition Programme; Concept of Operations for the Aeronautical Rescue Coordination Centre function by Her Majesty's Coastguard. Version 6.8 dated October 2015.

Missing / overdue aircraft

The D&D Cell are the lead organisation for overdue action and for instigating tracing action which includes checking alternative airfields, contacting other Air Traffic Control Centres and reviewing radar replays.

Missing aircraft are assigned one of three emergency phases that are defined in the ICAO IAMSAR³ taxonomy:

Uncertainty Phase: A situation wherein doubt exists as to the safety of an aircraft or its occupants.

Alert Phase: A situation wherein an aircraft or its occupants are having some difficulty and may need assistance, but are not in immediate danger.

Distress Phase: A situation wherein there is reasonable certainty that an aircraft or its occupants are in danger and require immediate assistance.

Concerns regarding the safety of an aircraft can be received from a number of sources including the general public and one of the 62 different Air Navigation Service Providers (ANSP) within the UK. Establishing the situation of General Aviation (GA) aircraft can be difficult as they do not generally file a flight plan and while they might request and obtain a Basic Service from an ANSP, the fundamental aspect of such a service is that it is non-surveillance. GA pilots who are not receiving a service are at liberty to change their route, or timings without informing anyone. Therefore, the D&D Cell will take into consideration the maximum endurance of GA aircraft before escalating the emergency phase. It is also not unusual for the D&D Cell to undertake tracing action for a GA aircraft to discover that the aircraft is parked in a hangar, or has flown to a different airfield.

Search and Rescue operation

On being informed by Scottish Information at 1115 hrs of their concerns for G-CEOF, the D&D Cell assistant on duty was tasked by his controller with contacting the operator of the aircraft, who reported that the aircraft was not due to arrive at Carlisle until 1200 hrs. When the aircraft did not arrive at the expected time, the D&D Cell initiated tracing action which included contacting the same ATC units as Scottish Information. However, there was no internal record of the actions taken. After the initial tracing action had been carried out, the D&D Cell requested a radar replay from NATS which identified a target, believed to be G-CEOF, which faded from the radar at 1050 hrs when it was approximately two miles north-east of Skipness.

At 1320 hrs, the D&D Cell alerted the ARCC of the incident, who verified the information by conducting their own inquiries which included contacting the same ATC units as the D&D Cell and Scottish Information. At 1356 hrs, the D&D Cell informed the ARCC of the outcome of the radar replay and the last known position of the missing aircraft. At 1401 hrs the ARCC

Footnote

³ International Aeronautical and Maritime Search and Rescue.

tasked a Coastguard helicopter that was operating in the Edinburgh area with conducting a search for the aircraft in the area where it was last seen on radar.

When the helicopter reached the search area at 1440 hrs, the crew received reports from a nearby vessel that wreckage had been sighted. The helicopter crew identified the wreckage near the last reported radar position of the aircraft at 1441 hrs and then two minutes later sighted a casualty in the water. The casualty, who was recovered by winch, had sustained fatal injuries. A second casualty, who was found close by and had also sustained fatal injuries, was recovered by an RNLI lifeboat. Neither the pilot or passenger were wearing a lifejacket.

Aircraft wreckage

Floating wreckage

The crew of the Coastguard helicopter reported that they had identified one of the aircraft wings floating in the water. The crew of the RNLI lifeboat recovered both pilot's seats, a bag containing the aircraft technical log and some personal items including the passenger's camera. The captain of a charter boat operating in the area reported that they had sighted the fuselage and cabin of the aircraft, which was missing both wings and the tail section. For safety reasons, the Coastguard instructed the captain not to put a line on the fuselage.

Underwater search

An underwater search of the area where the floating wreckage and casualties were sighted was carried out by the MoD Salvage & Marine Operations Project Team on 6 June 2017 using a towed side-scan sonar and an underwater, light weight, remotely operated vehicle.

The depth of water varied between 35 m and 55 m and the seabed consisted of undulating fine sand and mud which made the detection of small items difficult. Nevertheless, the left wing was found in 48 m of water, approximately 800 m from the shore of the Kintyre peninsula.

Location of wreckage and casualties

The locations of the casualties and wreckage extended over an area 800 m long and are plotted in Figure 1. It is possible that in the 12 days between the accident occurring and the underwater search beginning, some items of wreckage might have moved as a result of the extensive bottom trawling that is carried out in this area.

At the time of the accident, the wind was calm and the predicted tidal flow was 0.2 kt to the south; therefore, the floating section of wing could not have been the same section of wing found on the seabed. Given the tidal flow, it is likely that the floating wreckage may have settled in an area south of the accident site where submerged cables between Skipness Point and Arran are routed along the seabed; an underwater search could not be conducted in this area. The wreckage might also have remained afloat for some considerable time and moved further down the Firth of Clyde.

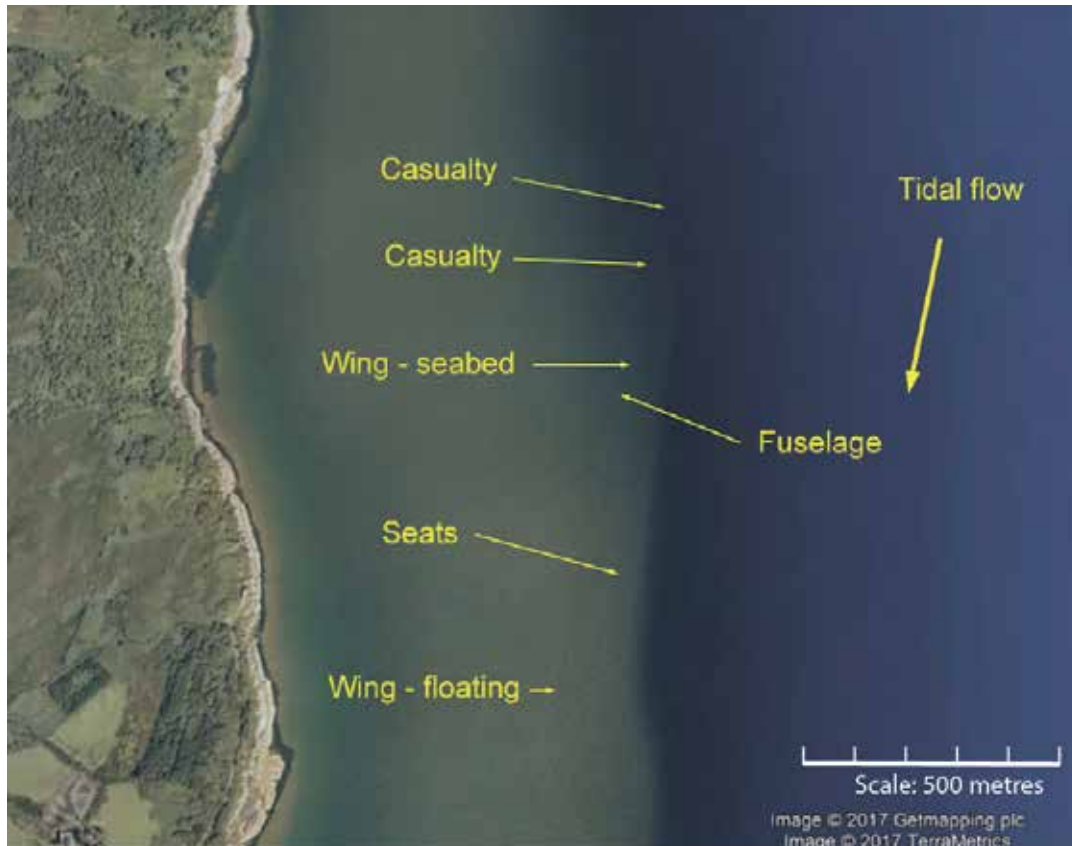

Figure 1

Reported position of casualties and wreckage

Meteorology

Met Office forecast

The Met Office forecast (below 10,000 ft), which was valid from 0800 hrs until 1700 hrs on 25 May 2017, reported extensive areas of poor visibility extending from the Irish Sea into Loch Fyne. The wind at 1,000 ft in the area of Skipness was forecast to be from the south at approximately 12 kt. The synopsis map is at Figure 2 and the accident occurred in Zone A. The Met Office text relating to Zone A reported:

'Zone A:

Widespread 3000 M in mist and occasional 200 M in fog, along with widespread hill fog. Isolated moderate turbulence was forecast near the fog until 1100 UTC. Cloud structure (all heights AMSL) was expected to be widespread stratus with bases 200-600 FT with tops 1500 FT, bases on the surface were allowed for in fog. Above this stratus, isolated areas of broken stratocumulus were expected in the far N.'

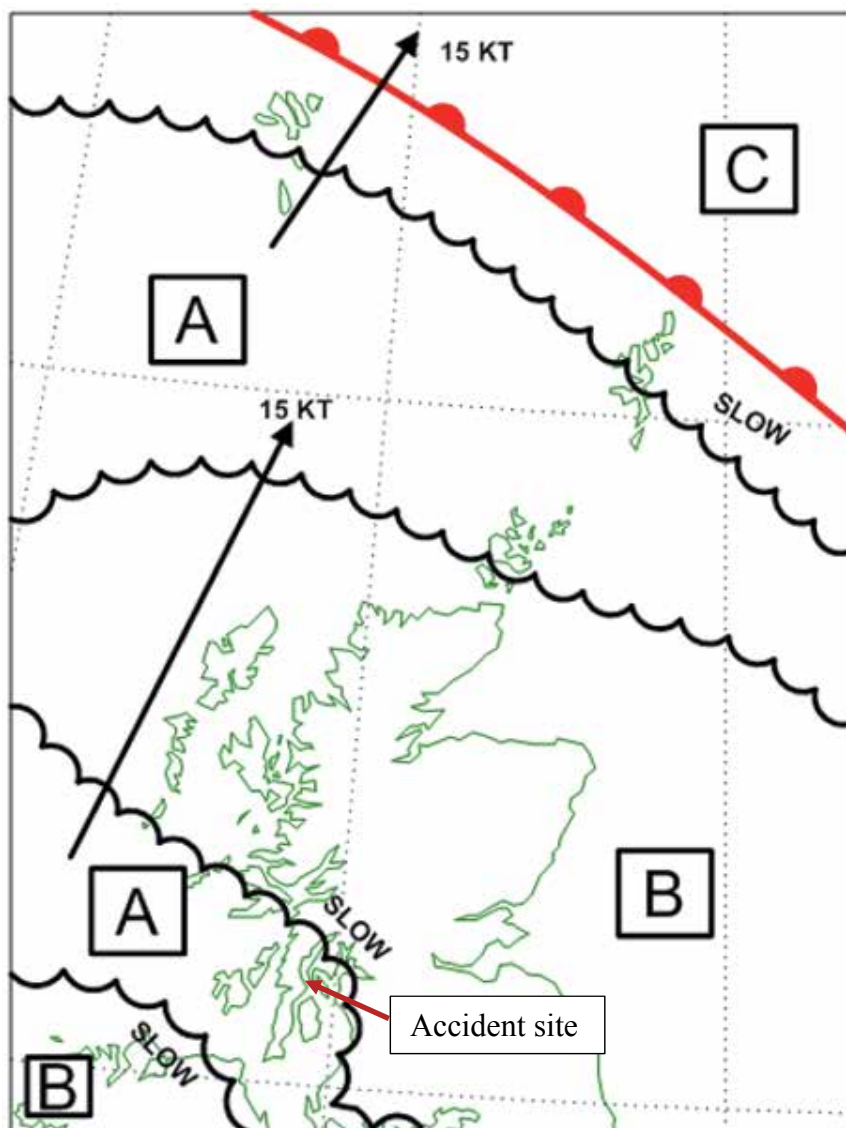
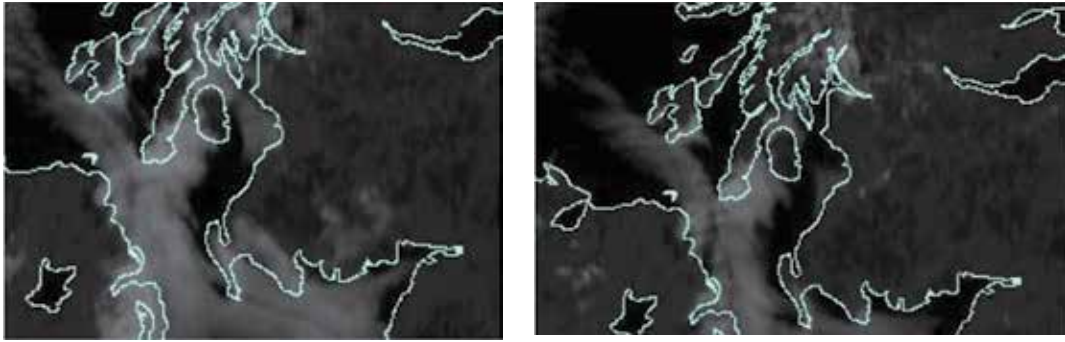

Figure 2

Met Office forecast, below 10,000ft, valid from 0800 hrs until 1700 hrs on 25 May 2017

High resolution visible satellite images

The Met Office high resolution visible satellite images taken at 1000 hrs and 1100 hrs on 25 May 2017 show areas of stratus or fog extending into Loch Fyne, with clear areas to the lee of high ground (Figure 3).



1000 hrs on 25 May 2017

1100 hrs on 25 May 2017

Figure 3

High resolution satellite image for 1000 hrs and 1100 hrs on 25 May 2017

Other observations

Two ferries operating in the vicinity of the accident site suspended services due to poor visibility. The MV Isle of Cumbrae operated a service across Loch Fyne between Tarbert and Portavaidie. The MV Catriona operated between Lochranza on the north of the Isle of Arran and Claonaig on the Kyle peninsula (Figure 4).

**Figure 4**

Routes of ferry services

In the ship's log for MV Isle of Cumbrae it was reported that at 0920⁴ hrs the visibility was less than 1 nautical mile, the service had been suspended and the ship remained in Portavadie until the weather improved at 1145 hrs. The ship's log reported the weather and sea state at 0730 hrs as '*SE AIRS, CALM SEAS, MOD-POOR VIS*' and at 0900 hrs as '*VAR AIRS, CALM SEAS, POOR VIS*'.

The entry for the ship's log for the MV Catriona at 1040 hrs was '*FOG FILLED IN AGAIN, 40 MTRS VIS, INFORMED ... SERVICE SUSPENDED*'. The weather and sea state at 0700 hrs was recorded as '*WIND NONE, MIST PATCHES, SEA CALM*' and at 1200 hrs as '*VERY THICK FOG, VISIBILTY DOWN TO 40 MTRS, NO WIND, SEA CALM*'.

The Tarbert harbour CCTV, which was located around 6.5 miles north of the accident site, showed drifting fog / mist in the entrance to the harbour. The AAIB estimated that the visibility at 1120 hrs was around 600 m.

Recorded information

From a camera recovered from the accident site, photographs and video clips were downloaded by the AAIB which showed the flight from Cumbernauld to Oban on 21 May 2017. Several of the images showed two mobile devices that were running a flight planning and mapping application.

Photographs

An image of the instruments taken when the aircraft was west of Glasgow showed the aircraft flying at an altitude of 1,250 ft and speed of 130 kt. Another image showed a printout of the Pilots Log (PLOG) for the flight, which had been generated by the flight planning application. The PLOG recorded that the pilot planned to fly to Oban at a cruise speed of 120 kt.

Mobile devices

The mobile devices were not recovered. However, the company that developed the application provided the date and time that these devices last communicated with the company's servers and provided the AAIB with copies of the flight plans that had been saved to their servers.

This information showed that the pilot had planned a return flight from Oban to Carlisle which was last modified on 25 May 2017 at 0649 hrs. His device last contacted the company's servers at 1022 hrs, which was around the time that G-CEOF departed from Oban. The planned route was from Oban, to the island of Luing, which lies approximately 18 miles to the south-west of Oban, south down the Sound of Jura towards Gigha Island before overflying Campbeltown and then onwards towards Carlisle.

Footnote

⁴ The times recorded in the ships logs and on the CCTV footage were all in Local and have been adjusted to UTC.

Three flight plans that had been saved to the company's servers on the evening of 20 May 2017 were recovered and showed planned routes from Cumbernauld to Oban. One of these routes showed a direct track from a point just south of Stirling to Oban, whereas the other two routes showed similar paths but included within their titles the words '*low level*'. The '*low level*' flight plans used Lochgilphead as an en route waypoint and roughly followed the Crinan Canal which is an area of low lying land.

Radar data

Radar data was obtained from two radar heads located at Tiree and Lowther Hill which showed the actual route of the aircraft during the flight to Oban on 21 May 2017 and the return flight to Carlisle on 25 May 2017 (Figure 6).

On 21 May 2017, the aircraft followed one of the planned '*low level*' routes, passing overhead Lochgilphead and routing to Oban via the Crinan Canal at an altitude which varied between 1,000 and 2,000 ft amsl.

On 25 May 2017, G-CEOF initially followed the planned route from Oban to the island of Luing, but then deviated inland flying along the Crinan Canal towards Lochgilphead, before heading south down Loch Fyne towards the Isle of Arran. The radar data showed that G-CEOF was abeam Lochgilphead at 1042:41 hrs at a height of 1,050 ft and then flew for a further 15 nm down Loch Fyne with the last radar return occurring 7 minutes 43 seconds later when it was at a height of 150 ft. During the first 10.1 nm from Lochgilphead, the aircraft descended approximately 300 ft until it was at a height of 750 ft abeam Tarbert. During the next 4.9 nm, there was an increase in the rate of descent which was estimated to be approximately 500 ft/min towards the end of the flight.

From the radar data, the AAIB was able to derive the aircraft's approximate groundspeed using a moving average calculation, which has been plotted, along with the altitude, at Figure 5 against the distance from the last radar return. There is a gap in the radar data as the aircraft passed Lochgilphead and before it was picked up by the second radar head.

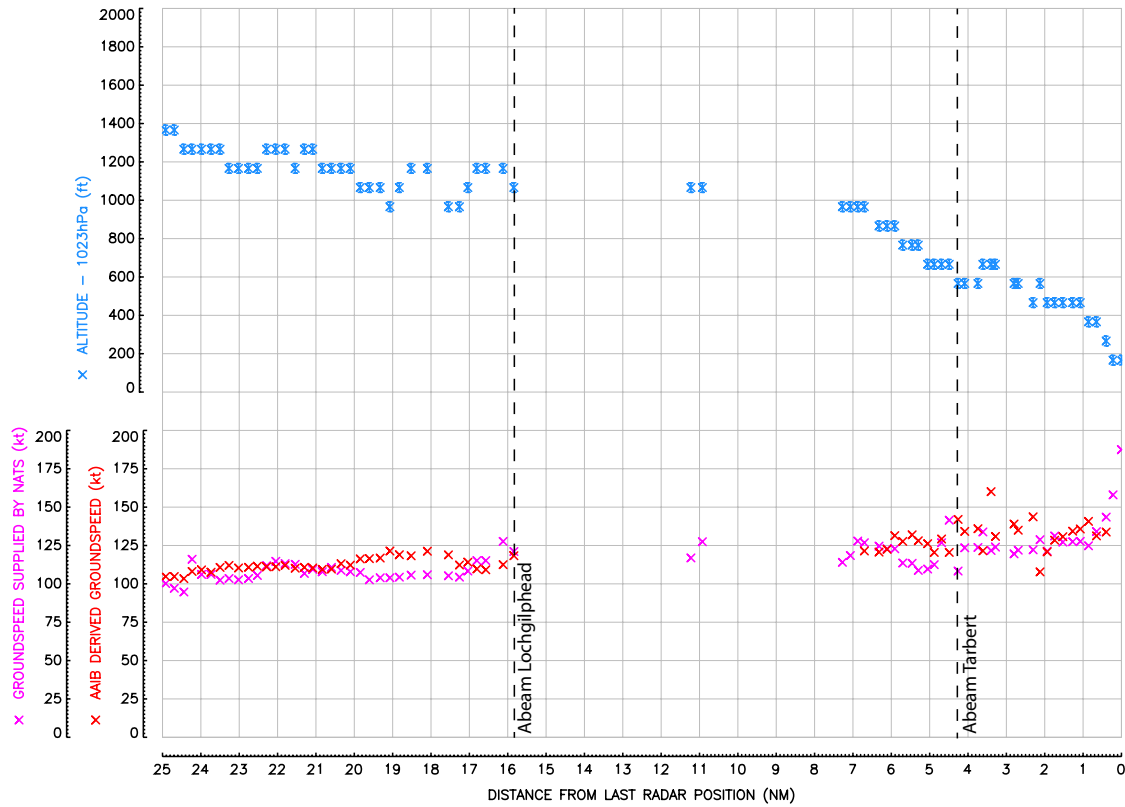

Figure 5

Aircraft altitude and derived airspeed plotted against the distance from the last radar return

Combined data overlay

Plotted at Figure 6 are the radar tracks for the flights from Cumbernauld Airport to Oban on 21 May 2017, the accident flight, and the planned route to Carlisle stored on the company’s servers. The tracks are overlaid with the Met Office satellite imagery taken at 1100 hrs on 25 May 2017.

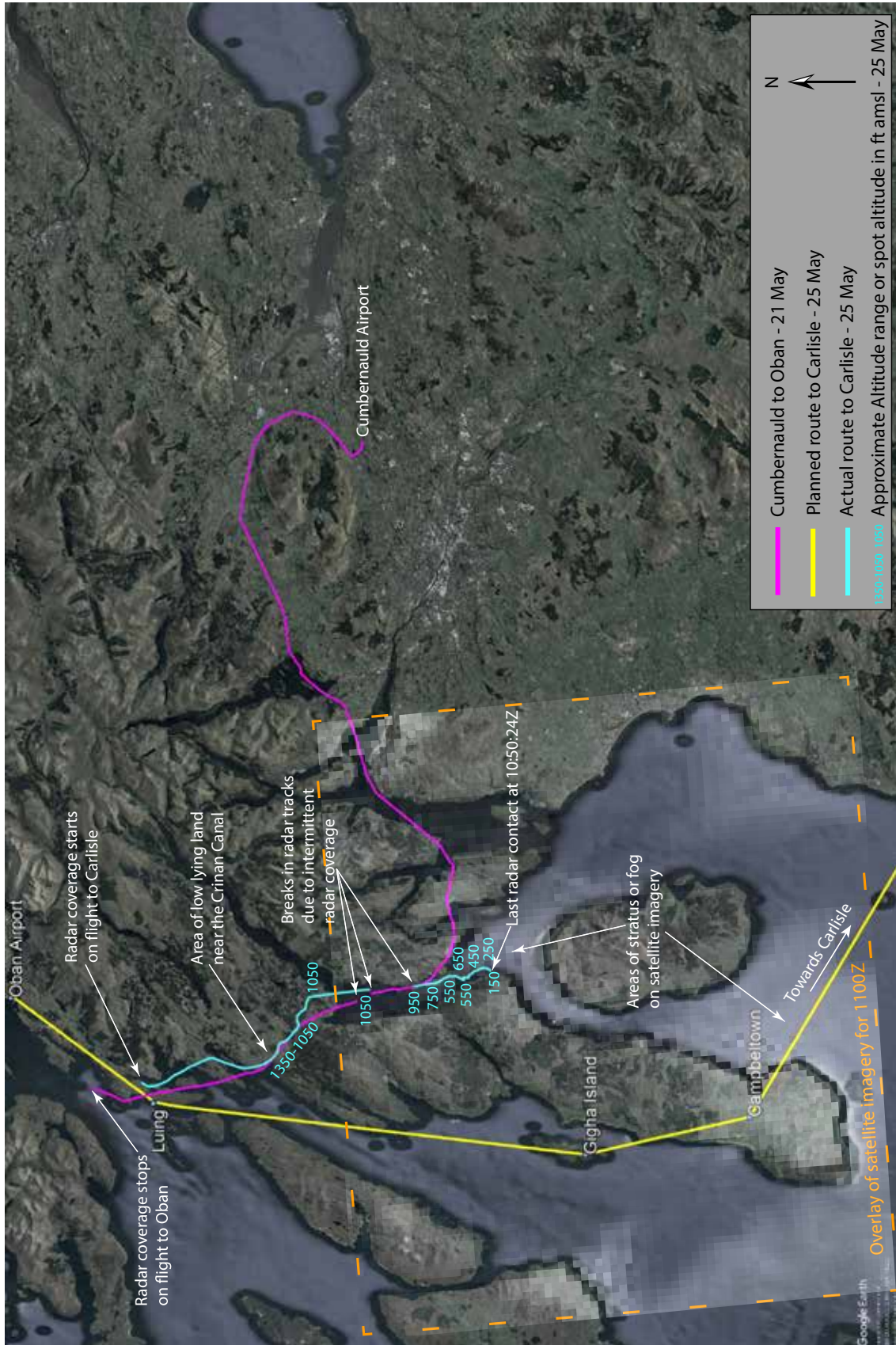

Figure 6

Radar track data and Met Office satellite imagery for 1100 hrs

Aircraft examination

Wreckage

The witness descriptions of the floating sections of the aircraft, the AAIB examination of the aircraft seats, and the condition of the left wing found on the seabed (Figure 7) all indicate that the aircraft broke up when it struck the water.



Figure 7

Left wing on seabed

Instruments

A video film recovered from the passenger's camera contained footage of the aircraft instruments when it was on base leg at Oban on 21 May 2017. From this footage it was determined that, with the exception of the Garmin GPS 150, all the avionics equipment was switched on and functioning. The needle on the suction gauge was at 5 in Hg and all the flight instruments appeared to operate normally. The engine parameters were in the normal range and the fuel selector was at the RIGHT position. The left fuel gauge indicated 30 US gal and the right gauge was at F (Full).

Fuel

The fuel records at Oban Airport show that at 1100 hr on 24 May 2017, 28.14 litre (7.4 gal US) of AVGAS was uploaded into the 'S' (right) fuel tank on G-CEOF. The fueller reported that the pilot only asked for the right⁵ fuel tank to be replenished in order to balance the plane. A video taken by the passenger after the aircraft landed at Oban showed the left fuel gauge reading 28 gal US and the right gauge approximately 30 gal US. There would therefore

Footnote

⁵ A photograph of the aircraft gauges show that on the ground it is the left fuel tank that had the lowest quantity.

have been approximately 250 litres (66 gal US) of fuel on the aircraft when it departed Oban, giving an endurance of approximately 6 hours.

The batch of fuel had been delivered on 11 April 2017 (15,000 litres) and the daily sampling checks carried out between 17 and 26 May 2017 found the fuel to be clear of water. There were no reports of any aircraft experiencing problems after uploading this batch of fuel.

Visual Flight Rules (VFR)

For a flight to operate under VFR, it must remain in VMC which is defined in terms of minimum visibility and distance from cloud. G-CEOF was operating below 3,000 ft amsl in Class G (uncontrolled) airspace. Regulation (EU) No 923/2012, SERA.5001, states that in such circumstances the minimum permitted visibility for flight under VFR is 5 km and the aircraft must also remain clear of cloud and within sight of the surface. However, SERA.5001 allowed the CAA to reduce the flight visibility requirement to 1,500 m for aircraft operating at speeds of 140 kt or less. The cruise speed of G-CEOF would have been less than 140 kt and therefore the pilot was permitted to fly VFR with the visibility as low as 1,500 m.

Medical

During the renewal of his Class 2 medical, a minor issue was noted on the pilot's electrocardiogram (ECG) trace and he was required to undertake a further and more extensive ECG examination. While this examination noted the existence of a conduction defect, it was considered sufficiently minor for his medical to be reissued without restriction or the need for further treatment. The post-mortem report for the pilot also noted an issue with an enlarged heart and that may have been symptomatic with a cardiac arrhythmia. Medical opinion was that such a symptom would not have been sufficient to constitute a factor in the pilot's capacity to operate the aircraft. There were no other relevant medical issues identified in the post mortem report.

Pilot's qualification and experience

The pilot's log book was lost in the accident and the following information was established from records held by two flying schools, a copy of his licence and two pages of his log book that were made by the operator when he hired the aircraft.

The pilot completed his PPL(A) Skill Test on 10 May 2014 and the only endorsement on his licence was SEP (Land). He converted to the PA-28 Arrow on 10 April 2016 and flew the aircraft regularly with an aircraft group based at Blackbushe Airport.

His training records show that during February and March 2016 he undertook three instrument flying training flights that included climbs and descents, rate 1 turns, partial panels, recovery from unusual attitudes and ILS approaches. His log book entries show that he then commenced IMC training on 20 December 2016 and over the following two months undertook three flying lessons that lasted for a total of 3 hours and 50 minutes of which 1 hour 30 minutes was logged as instrument flying. A flight undertaken on 5 January 2017 logged 50 minutes of Dual / P2 night flying.

One hour of simulated instrument flight on an FNPT1⁶ simulator at Wycombe Airport was logged in the pilot's log book for 8 and 13 March 2017. The instructor who conducted the simulator session stated that the pilot had said that he wanted to practise instrument flying and that as he had not started an IMC course the hours did not count towards his IMC rating.

In April 2017, the pilot started the process of converting onto the Cessna 182 and flew two flights on 6 and 12 April 2017 totalling 1 hour 40 minutes.

The summary for the last entry in the pilot's log book, that included flights up to and including 20 May 2017, recorded that he had flown a total of: 5.8 hours night flying; 12.5 hours instrument flying and 2 hours simulated instrument flying.

The pilot did not complete the IMC course syllabus and at the time of the accident did not hold an IMC / Restricted Instrument Rating (IR/R).

Human factors

Difficulty in judging height over water

Pilots flying under VFR rely on visual references, such as the horizon, to establish the attitude of the aircraft. If the horizon is obscured or difficult to define, then the attitude of the aircraft can be maintained by visual reference to the surface below. However, when flying in low visibility conditions over a calm expanse of water there might be insufficient visual cues to allow the pilot to establish the attitude and height of the aircraft without reference to the aircraft's flight instruments.

Decision making by a pilot

In the AAIB report into an accident involving a Piper PA-30 that flew into high ground during poor weather⁷, the AAIB discussed the factors which affect a pilot's decision making. The report also quoted Sydney Dekker who in his book *The Field Guide to Understanding 'Human Error'* states:

'Conditions often deteriorate gradually and ambiguously, not precipitously and unequivocally. In such a gradual deterioration, there are almost always strong initial cues that suggest that the situation is under control and can be continued without increased risk. Later cues that suggest the plan should be abandoned ... even while people see them and acknowledge them, often do not succeed in pulling people into a different direction.'

Footnote

⁶ Flight Navigation Procedures Trainer (FNPT), as defined in EASA CS-FSTD (A) for fixed-wing aircraft, but in essence a lower level training device than a Full flight simulator or Flight training device.

⁷ AAIB Report EW/C2017/01/01, Piper PA-30, registration G-ATMT.

CAA advice to GA pilots

The CAA publishes the Skyway Code⁸ which provides advice to GA pilots on the planning and the safe conduct of their flights.

The Code contains the following advice to pilots:

VFR minima

For operations in class G airspace the legal VFR minima allow flight in potentially very poor conditions. Clear of cloud and visibility of 1500 m is all that is required if below 3000 ft AMSL and flying at less than 140 kts.

In reality, the limiting factor is usually cloud rather than in-flight visibility – in conditions approaching 1500 m visibility, the cloud ceiling would likely mean flying dangerously low. The legal minima are not a good reference point for decision making because safe VFR flight normally ceases to be possible long before the visibility is that poor. They are limits not targets.

Full flight plan

Details of how to file a full VFR flight plan using the AFPEX system are contained in the 'International Flying' chapter (see p.154). A full flight plan may be filed for any flight, but it is a requirement for flying internationally. It is also recommended to file one if:

- > Flying over water, more than 10 NM from the UK coastline;*
- > When flying to the Scottish Highlands and Islands aerodromes; and*
- > Over other sparsely populated areas where search and rescue might be difficult.'*

Analysis

Aircraft

G-CEOF was equipped to fly in IMC conditions and a video clip and photographs taken during the flight to Oban by the passenger showed the flight and navigation instruments working normally. The operator reported that there were no known faults on the aircraft and the pilot and passenger made no mention of problems with the aircraft after arriving at Oban.

From the refuelling records at Oban, and cockpit photographs that showed the aircraft fuel gauges after it landed, it was estimated that on the return flight to Carlisle the aircraft had sufficient fuel on board to remain airborne for approximately 6 hours.

Footnote

⁸ http://publicapps.caa.co.uk/docs/33/CAA6395_Skyway_Code_AW_150817_SCREEN.pdf

Wreckage

The wreckage of the aircraft was found close to the last radar contact. While the aircraft was not recovered, the floating wreckage and the condition of the left wing found on the seabed indicate that the aircraft did not undertake a controlled ditching, but broke up when it struck the sea. The post-mortem examination revealed that the pilot and passenger both sustained fatal injuries during the impact, which was not survivable.

Prevailing weather conditions

The Met Office forecast fog, mist and low cloud in the area south of the Crinan Canal with visibility in some places as low as 200 m. The cloud base was forecast at 200 to 600 ft with the tops at 1,500 ft. High resolution satellite images, Tarbert harbour CCTV and the entries in the logs of two ferries all confirmed the presence of low stratus cloud or fog, south of Lochgilphead at the time of the accident.

The pilot delayed his departure until 1025 hrs when the weather at Oban and Carlisle had improved. From his conversation with the FISO at Oban, when he told him that there was low cloud at Campbeltown and Islay, it is evident that the pilot had checked the weather en route; however, the source of where he obtained this weather forecast could not be established.

While the flight started in VMC, after the aircraft passed Tarbert, it is likely that the visibility had reduced below 1,500 m such that the aircraft was being flown in IMC.

The pilot

The pilot had a current Class 2 medical and the post-mortem and review of his medical records did not identify any condition that would affect his ability to operate the aircraft. The instructor who conducted the check flight at Carlisle raised no concerns at the pilot's ability to fly the aircraft. The pilot had logged 12.5 hours of instrument flying and had undertaken two hours of instrument training in a simulator two months before the accident; however, he was not qualified and had not completed the required training to fly unsupervised in IMC.

The accident flight

The pilot had mentioned to a number of witnesses that he intended to return to Carlisle via Campbeltown, which was consistent with the planned flight recovered from the planning and mapping application. Another witness mentioned that the pilot had told him on the morning of the flight that he would route closer to Prestwick. The radar track of the accident flight shows that the pilot did not fly the planned route, but instead flew along low-lying land to the east of the Crinan Canal. The pilot was familiar with this area as he had flown through it several days earlier on his flight from Cumbernauld to Oban. This route would also have shortened the flying time by approximately 10 minutes and would have kept the aircraft clear of high ground around Campbeltown. However, the route would have taken him towards an area of poor visibility.

The pilot reported, via a relay call to Scottish Information, that he was overhead Lochgilphead at a height of 1,000 ft; the radar trace showed the aircraft at 1,050 ft to the east of

Lochgilthead. The pilot made no mention of any problems with the aircraft. Over the next 10.1 nm the aircraft descended 300 ft until it was abeam Tarbert at a height of 750 ft. Over the next 4.9 nm the aircraft's rate of descent increased and was approximately 500 ft / min before it disappeared from radar.

The NATS and AAIB derived ground speeds remained relatively constant as the aircraft approached and passed Lochgilthead, with no evidence of the aircraft having slowed down. From the forecast winds provided by the Met Office, the aircraft flew down Loch Fyne at an airspeed of approximately 130 kt, which is consistent with the cruise speed of the aircraft and the speed that it was flown on the flight from Cumbernauld to Oban.

As the pilot flew south down Loch Fyne the reducing visibility would have made it more difficult to identify the horizon. Therefore, he would have been dependent on other visual cues such as the surface of the water or the shoreline on either side of the Loch. However, the surface of the water would have been relatively calm and it would have been difficult for the pilot to detect changes in height without reference to the aircraft instruments. His PPL training would have taught him that the preferred course of action following inadvertent IMC was to perform a 180° turn. His other option was to climb above the cloud. It is possible that the high ground on both sides of Loch Fyne may have deterred him from performing a 180° turn. While he did not hold an IMC qualification he had experienced instrument flying which might have been sufficient for him to climb above 1,500 ft where the visibility would have been considerably better.

With a gradual reduction in visibility, the pilot might not have been aware how poor the conditions had become and there was no evidence that he reduced his airspeed to give himself more time to react to any external visual cues. He was probably using the application on his mobile device to remain on track and clear of high ground, which may have reduced the time available to scan his flight instruments and look for external visual cues. The descent as the aircraft passed Tarbert might have been flown in order to remain in sight of the water and to increase the pilot's forward visibility as he descended clear of the cloud base. However, he was flying into a fog bank which started at sea level.

This was the passenger's third flight in a light aircraft so it is unlikely, in these conditions, that he would have been able to assist the pilot. Flying in such conditions would have markedly increased the pilot's workload, and stress, while reducing his capacity to make decisions. He might, therefore, not have considered the other options and may have instead focused on identifying external visual cues to the detriment of using his altimeter to maintain a safe height above the water.

Time pressure

The pilot had already been delayed by 24 hours and before departing Oban had arranged for a taxi to meet him at Carlisle to take him and his passenger to the railway station. The change from the flight plan on his mobile application would have shortened the flight time by around 10 minutes. However, the investigation was unable to establish if the pilot felt that he was under any time pressure to return to Carlisle.

Conclusion

Poor visibility had been forecast south of Lochgilphead and as the aircraft flew down Loch Fyne, the visibility would have reduced to below that permitted for VFR flight. The pilot was not qualified to fly in IMC and it is concluded that the accident probably occurred as a result of the aircraft being flown, in poor visibility, into the sea.

AAIB comment

The AAIB investigates a number of accidents that are similar to this one each year, which occur throughout the UK. Common themes in these accidents are: marginal weather conditions, the pilot does not recognise that the weather has deteriorated below safe limits, or continues to press on. In many cases, actions such as performing a 180° turn, rerouting, diverting or climbing to a minimum safe altitude are not always taken.

Missing / overdue action was initiated by the FISO within 20 minutes of the aircraft accident, and information was passed to the D&D Cell who started tracing action. However, SAR assets were not tasked until two hours 45 minutes later, after the last position of G-CEOF had been identified on radar by the D&D Cell. The RNLI life boat and the Coastguard helicopter arrived on the scene 40 minutes after they had been tasked. While the occupants of G-CEOF were fatally injured in the impact, had they survived a ditching, or a forced landing in a mountainous or remote area, then the outcome might have been dependent on the speed of response. It is for this reason that both the CAA and the D&D Cell recommend that GA pilots who fly in the Scottish Highlands and Islands, or other remote areas, should file a flight plan.

Safety actions

While this accident was not survivable, the Department for Transport and the Royal Air Force D&D Cell have initiated a number of safety actions to reduce duplication of effort and ensure that the required actions are carried out in a timely manner.

The D&D Cell

The D&D Cell undertook a broad review of their procedures for dealing with missing / overdue GA aircraft in order to reduce the timeframe during the uncertainty phase. They have introduced a standard checklist for their staff which has been shared with NATS and the ARCC. The D&D Cell have also reduced the time for requesting a radar replay for GA events and the request to NATS will now be actioned no later than 30 minutes after an aircraft's Estimated Time of Arrival, or the start of tracing action. The new procedures will also help to reduce duplication of effort across the ANSPs, the D&D and the ARCC. The introduction of improved log keeping and data gathering will also help to better inform future decision making.

Review of the D&D Cell and ARCC processes

The Department of Transport has initiated a review of the processes and procedures carried out by the D&D Cell and ARCC. The intention is to map the roles and responsibilities of both organisations, identify any duplication and consider if processes can be streamlined.

ACCIDENT

Aircraft Type and Registration:	Silence Twister, G-JINX
No & Type of Engines:	1 Ulpower UL260iSA piston engine
Year of Manufacture:	2013 (Serial no: LAA 329-15102)
Date & Time (UTC):	14 May 2017 at 1330 hrs
Location:	MOD Abingdon, Oxfordshire
Type of Flight:	Commercial operation
Persons on Board:	Crew - 1 Passengers - None
Injuries:	Crew - 1 (Serious) Passengers - N/A
Nature of Damage:	Aircraft and engine severely damaged
Commander's Licence:	Private Pilot's Licence
Commander's Age:	49 years
Commander's Flying Experience:	1,154 hours (of which 259 were on type) Last 90 days - 15 hours Last 28 days - 13 hours
Information Source:	AAIB Field Investigation

Synopsis

During a formation aerobatics display of a pair of aircraft at MOD Abingdon the engine of the number 2 aircraft lost power and then stopped in flight. The subsequent attempted forced landing onto the runway at Abingdon was unsuccessful.

The investigation found that the engine seized following the loss of its oil during the accident flight.

Several safety actions have been taken by the engine manufacturer, the owner, and the Light Aircraft Association.

History of the flight

The accident aircraft was the following or 'number 2' aircraft¹ in a formation of two Silence Twisters that were scheduled to fly a formation aerobatic display at the Abingdon Air and Country Show, at MOD Abingdon, Oxfordshire.

The two aircraft flew from their base in Buckinghamshire and landed at Abingdon prior to their display. During the preparation for the display, the pilot of G-JINX checked the engine's oil quantity and found it was indicating full.

Footnote

¹ Aircraft flying in formation may be numbered according to their position in the formation. The formation leader is number '1' and subordinate aircraft are numbered '2' onwards.

As the aircraft from the previous display positioned to land, the two Silence Twisters took off in formation, and were cleared to commence their display by the display controller once these aircraft had landed. At the time the weather was fine with wind from 260° at 12 kt. Runway 18 was in use with the western side of the runway established as the 150 m crowd line² (Figure 1).

The first few minutes of the display proceeded without incident. However, the accident pilot became aware that G-JINX's engine appeared to have been underperforming during the 'barrel' rolls that formed the second manoeuvre in the display sequence, and transmitted to the leader to reduce power slightly because he was unable to maintain the correct formation position.

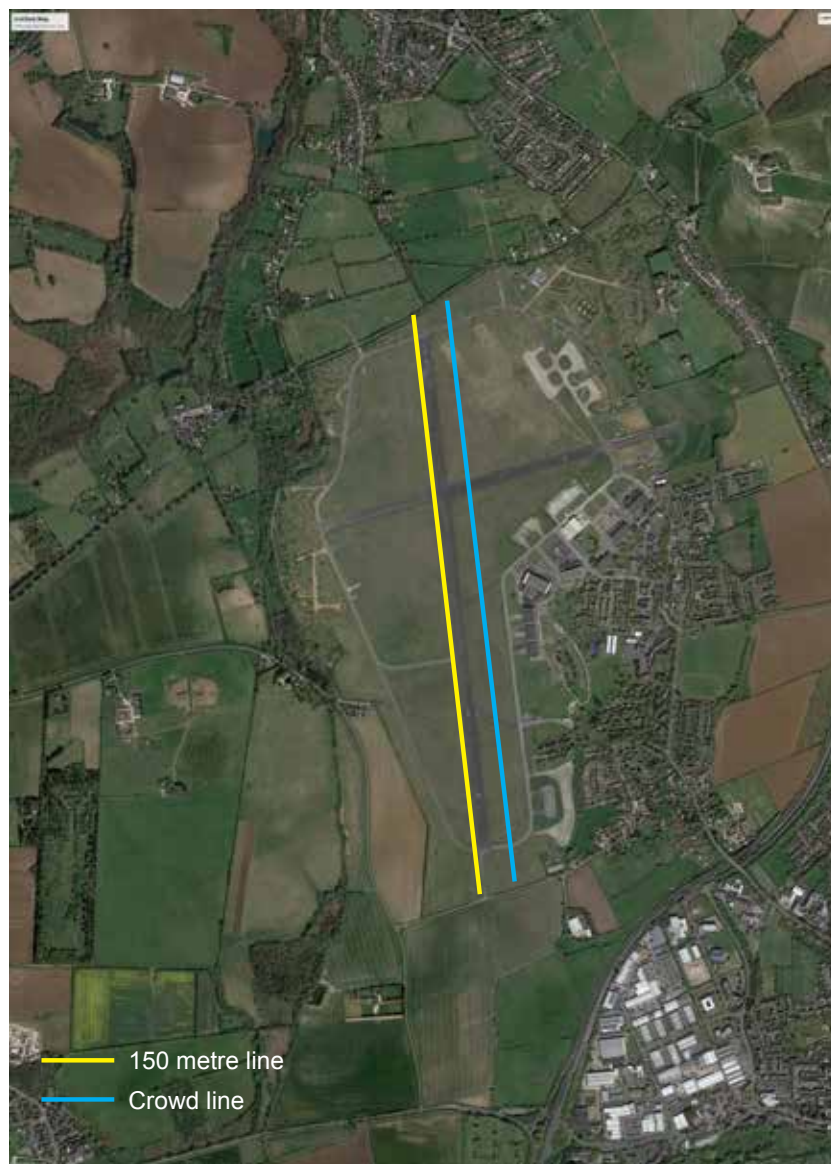

Figure 1
Overview of MOD Abingdon Airfield

Footnote

- ² 150 m is the minimum distance from the crowd line that display aircraft, with a MTOM less than 1,200 kg and speed less than 150 KIAS, are permitted to fly, in accordance with CAP 403.

After the next manoeuvre, a stall turn, the leader transmitted “ARE YOU GOING TO BE OK...YOU’RE A BIT LOW” to which the accident pilot replied “I AM VERY LOW ON ENERGY HERE” followed a few seconds later by “I’VE GOT A PROBLEM, I’M LANDING OFF THIS [manoeuvre]”. At this point G-JINX was downwind, about half way along Runway 18, approximately 200 ft aal and 200 m displaced from the runway’s centreline. The pilot then converted the aircraft’s remaining excess speed to height and momentarily turned left, to try to displace the aircraft further away from the runway. Whilst the engine was still running the pilot commenced a tight descending right turn to align with the runway. During the turn the engine stopped. The aircraft struck the grass to the east of the runway, with its landing gear and flaps retracted, in a wings-level and slightly nose-down attitude. The aircraft bounced and slid to a halt. The formation leader, who was unaware of the accident, continued with the display.



Figure 2

G-JINX after accident
(Picture courtesy of Peter Thomas)

The display controller declared an aircraft accident and sent all on-site rescue resources to the scene, the first arriving within 50 seconds of the aircraft coming to a halt. The pilot was found slumped forward in the cockpit unconscious. The RFFS could not find a way to open the canopy and, as the pilot’s head was very close to the canopy, did not want to break it. The pilot then regained consciousness and opened the canopy from the inside. He was subsequently lifted out of the aircraft and taken to hospital where it was discovered he had sustained serious injuries.

Accident pilot’s comments

The pilot of the accident aircraft commented that the difference in performance between the two aircraft, that he experienced during the barrel rolls and the quarter clover, was not unusual. He had experienced comparable differences, with some difficulties staying in position, during previous displays. He added that it is a “subtle art” to remain in close formation given that the aircraft’s engine has 107 hp.

The pilot commented that he made a “quick scan” of the engine instrument after the barrel rolls, when he was not close to the leader, and during the time that he closed back into the correct position before the next manoeuvre, noting that all engine parameters were within limits. However, he became aware he had an engine problem during the stall turn. At the end of this manoeuvre the engine was still turning and producing power, and despite a brief glance at the instruments, the pilot did not notice any engine warnings. He added it was possible he may have missed any warnings during the ‘glance’, as most of his attention was outside of the cockpit as he subsequently concentrated on the landing the aircraft.

Having elected to discontinue the display the pilot made a quick assessment of potential landing options. However, given his low height and proximity to the runway, and with no suitable options ahead or to the left (ie away from the crowd) due to wooded areas and villages, he elected to attempt to land on the runway. At that point the engine was still turning but its power was reducing rapidly. The pilot believed the engine stopped about 2 to 3 seconds before the impact.

The pilot recalled that he flew a tighter turn than he would have wished due to the limited lateral offset available to line up with the runway and the presence of the crowd line beyond. He commented that there is an imperative placed upon display pilots not to breach the separation distances from the crowd.

Aircraft information

General

The Twister is classed as a ‘Group A’ aircraft and the basis for its design approval is the EASA Certification Specification for Very Light Aeroplanes (CS-VLA). A Type Approval (TADS 329) was issued by the Light Aircraft Association (LAA).

G-JINX was registered on 14 October 2011 and was operated on a CAA Permit to Fly administered by the LAA. The last Certificate of Validity was issued on 6 April 2017 and was valid until 5 April 2018.

Aircraft

The Twister is a single-seat, low-wing aircraft fitted with conventional flying controls, a retractable landing gear and flaps. The aircraft is constructed from honeycomb composites, reinforced with carbon and glass fibre, and incorporates a cockpit safety cell manufactured from Kevlar. The aircraft has a safe load factor of +6/-4g at the maximum takeoff weight at a manoeuvre speed of 98 kt. The pilot sits in a reclined position on an energy absorbing seat cushion and is secured by a four-point harness and a separate lap strap.

Canopy

The aircraft is equipped with a one-piece bubble canopy hinged along the right side. The canopy is unlatched by operating a white handle on the left side of the cockpit (Figure 3). To jettison the canopy, the white handle must be operated at the same time as a second black handle on the right side of the cockpit, which removes the pins from the canopy hinges (Figure 4).



Figure 3

White canopy opening handle



Figure 4

Black canopy jettison handle

There are no canopy opening or jettison handles on the outside of the cockpit; however, it can be unlatched by reaching through the small ventilation window and operating the white handle (Figure 5). There were no instructions visible from outside the cockpit explaining how the canopy is opened.

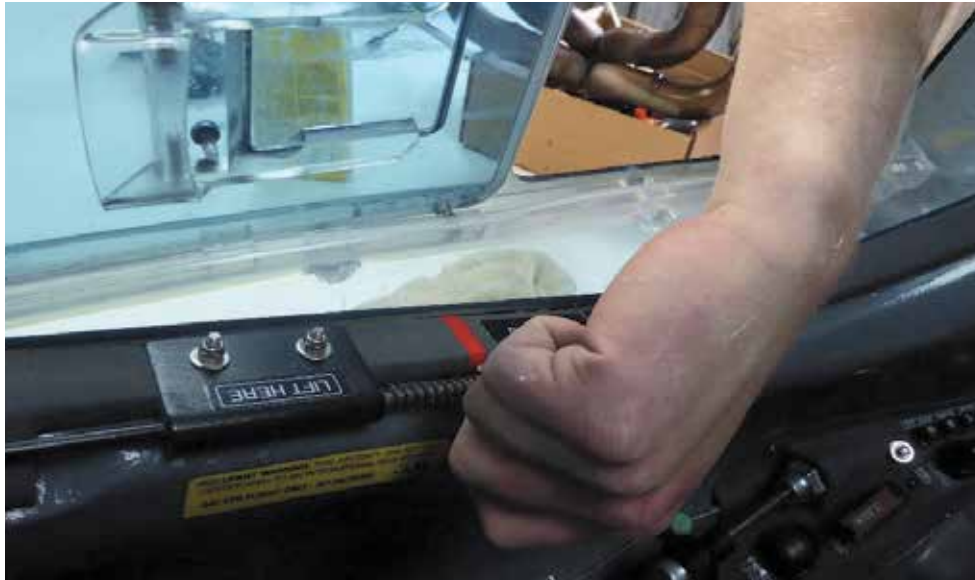

Figure 5

Opening the canopy from outside of the cockpit

The CAA advised that the Certification Specifications (CS) for Very Light Aeroplanes (CS-VLA) may be considered as guidance for the Silence Twister. Article 807 refers to emergency exits, Article 1541 to markings and placards, and Article 1555 to control markings:

'CS-VLA 807, Emergency exits

(b) The opening system must be designed for simple and easy operation. It must function rapidly and be designed so that it can be operated by each occupant strapped in his seat, and also from outside the cockpit...

CS-VLA 1541, markings and placards General

(b) Each marking and placard ...

(1) Must be displayed in a conspicuous place ...

CS-VLA 1555, control markings

(d) When an emergency exit is provided in compliance with CS-VLA 807, each operating control must be red. The placards must be near each control and must clearly indicate its method of operation.'

The cockpit and canopy on the Twister is similar to that used on sailplanes, which are required to conform to CS-22. Article 22.780 details the colour markings and arrangement of the cockpit controls and specifies that the canopy operating handle should be white and the jettison handle red. It also states that if the opening and jettison handle are combined in one handle then the colour must be red.

The Silence Twister is not required to conform to these specifications.

Avionics

G-JINX was one of three aircraft built from a kit by the current owner and was fitted with a Dynon Avionics EFIS-D10A (Electronic Flight Information System) ADAHRS³ that incorporated the engine and fuel sensors, and EMS-D10 (Engine Monitoring System) that incorporated the engine and fuel sensors. The EMS constantly monitors several parameters and displays the value as a number and position on a digital gauge. When the parameter is within the normal operating range the needle, or indicator on the digital gauge, will be in the green range. If the parameter is outside of the normal operating range then a yellow or red alert will be generated. This is indicated to the pilot by the background to the numerical value flashing yellow or red. The red alert is also accompanied by a red message across the bottom of the screen. The EMS was capable of producing an audio alert to the pilot, through the intercom, but this function was not enabled at the time.

Display smoke

G-JINX was fitted with a tank, located behind the pilot's seat, which contained the oil that was injected into the exhaust pipe during the display to produce smoke.

Engine - general

G-JINX was fitted with a 107 HP, UL260iSA four cylinder, air cooled, four stroke piston engine and a two blade fixed pitch propeller. The UL260iSA is a modified version of the UL260iS engine developed for use in aerobatic aircraft. The cylinders are numbered as shown in Figure 6 with cylinders 3 and 4 at the rear of the engine.

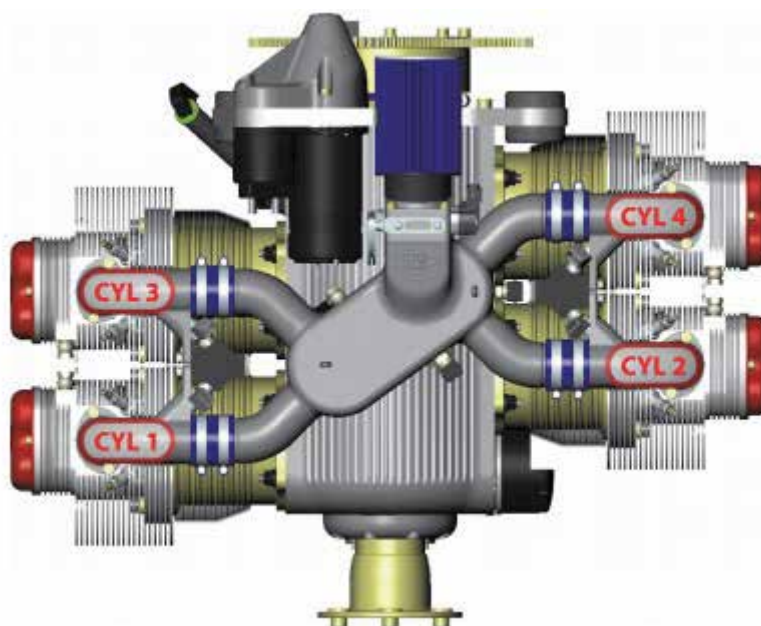

Figure 6

Numbering of engine cylinders

Footnote

³ Air Data, Attitude and Heading Reference System.

The engine is equipped with a dual electronic ignition and a multi-point fuel injection system controlled by an Electronic Engine Management System (EEMS). Prior to the accident involving G-JINX, the engine operating manual stated that the engine was permitted to run on unleaded automotive fuel (MOGAS) with a minimum octane rating of 98 RON, or AVGAS 100LL if the specified fuel was not available.

The engine operating manual stated that the UL260iS variants can be run at the maximum power setting of 107 hp at 3,300 rpm for five minutes, and for an unlimited period at the maximum continuous power setting of 95 hp at 2,800 rpm. The engine manufacturer advised the AAIB that providing the other engine parameters are within limits, the engine can be operated at the maximum power setting beyond the specified limit of five minutes.

Engine – aerobatic variant

The UL260iSA engine is a modified version of the UL260iS engine where changes have been made to the engine casing, oil sump and oil 'pick-up' system to allow the engine to be flown inverted for extended periods. The owner of G-JINX worked with the engine manufacturer in developing the aerobatic variant of the engine and was the first customer to fit this variant to his aircraft. At the time of the accident, several hundred UL260iS engines and between 12 and 15 UL260iSA engines were in service.

The owner of G-JINX had four aerobatic engines which he rotated between his three Twister aircraft that he used for the aerobatic displays. The engine fitted to G-JINX had completed 676 engine hours and was thought to be the fleet leader. The other three engines had accumulated 198 hours, 523 hours, and 540 hours respectively.

Engine – oil system

The engine oil system is equipped with two oil inlet pipes, with one pipe fitted at the top and one fitted at the bottom of the engine. Both pipes are connected to an 'inverted oil valve', which consists of a valve body with three ports and two steel balls kept apart by a spring. Gravitational forces act on the steel balls, which move against the springs to uncover and close the oil inlets at the top and bottom of the engine. The inlet pipe at the bottom of the engine is fitted to a swivel coupling, which can rotate rearwards by 60° and forward by 30°, to ensure that the mouth of one of the inlet pipes is always submerged as the pitch attitude of the aircraft changes.

The oil breather system incorporates an oil separator tank which is connected by flexible inlet breather pipes to the top and bottom of the engine. A separator tank is also connected to the engine exhaust by the exit breathe pipe. A valve within the separator tank, operated by gravitational forces, opens and closes the inlet breather valves depending on the attitude of the aircraft. Oil collected by the separator is retained in its tank and the air is discharged through the exit breather pipe to the engine exhaust. The owner reported that it is normal for a small amount of oil to be discharged into the exhaust when the aircraft transitions from erect to inverted flight.

The engine oil is cooled by an external oil cooler mounted at the front of the engine. The minimum and maximum oil levels for the engine are 2.5 and 3.5 litres. The normal oil

pressure depends on the oil temperature, but should be between 30 and 75 psi. The engine operating manual states that the engine should not be operated if the oil pressure is below 14.5 psi. On G-JINX, the owner had set the EMS to generate warnings when the oil pressure was between 20 and 27 psi (yellow warning) and below 20 psi (red warning).

Engine – cooling

The engine is cooled by ambient air and engine oil. Ambient air is directed through two inlets at the front of the engine cowling and is guided by ducts over the cylinder heads and the upper part of the cylinders.

At an engine speed of 3,000 rpm, the oil flows through the engine at approximately 24 litres per minute. This oil is directed to the crankshaft, camshaft, and rocker arms to provide lubrication and cooling. The oil leaving the crankshaft and conrod bearings is directed to the bottom of the pistons where a mist of oil is created that lubricates the piston walls and cylinder bores.

The manufacturer advised that it is not unusual for the two rear cylinders (numbers 3 and 4) to run slightly hotter than the front cylinders.

Flight manual

The aircraft's flight manual states that the minimum speed with flaps retracted is 44 kt (V_s). It also states the following in the section on emergency procedures:

'Emergency landing with stopped engine

- 1. Airspeed 65 kts*
- 2. Make Mayday radio call*
- 3. Fuel selector valve closed*
- 4. Ignition off*
- 5. Lower the undercarriage (if landing area is uneven or soft, land with undercarriage retracted)*
- 6. Flaps as necessary (30° is recommended)*
- 7. Main switch off (when landing is absolutely certain)'*

Aircraft examination

The aircraft and engine were initially examined by the AAIB at the owner's workshop after he had moved the aircraft, with the permission of the AAIB, from the accident site. The engine was dismantled under the supervision of the AAIB and returned to the manufacturer for a more detailed examination.

Aircraft

The airframe and wings were damaged during the impact; however, the canopy, cockpit area and fuel system remained intact. There was sufficient fuel in each of the two fuel tanks

for the aircraft to have completed the flight. Both electric fuel pumps operated normally, the fuel was clear and there was no evidence of debris in the gascolator.

The EEMS, EFIS, and EMS operated normally when electrical power was applied to the aircraft.

The outlet pipe from the display smoke oil tank fractured during the accident allowing oil to leak into the cockpit area.

Engine

The oil cooler had been damaged during the accident and the owner reported that the engine oil had leaked out subsequently. When the AAIB examined the engine, the oil level did not register on the dipstick. There was no evidence of an external oil leak other than from the oil cooler.

The engine could not be rotated by hand. Externally there was no obvious damage other than to the oil cooler and propeller. On removing the cylinder heads it was discovered that the No 3 piston had been badly damaged and a significant section had broken away (Figure 7). There was no evidence of detonation or cracking of the piston. The inside of the cylinder was dry, and marks on the side of the piston and inside of the cylinder bores indicated that the piston had seized in the cylinder. The piston rings and scraper had all been damaged. The remaining three cylinders were also dry and there was damage to the sides of all the pistons and cylinders indicating that the pistons had expanded and had started to 'grab' the side of the cylinder.



Figure 7

Damage to No 3 piston and cylinder

The spark plugs, piston and cylinder heads were a light grey in colour indicating that the

engine management control system and spark plugs had operated correctly. The connecting rod bearing shells showed signs of wear and slight damage. The piston pins and conrods all had a blue tint which is an indication of overheating. The cooling vanes adjacent to the cylinder head securing bolts were slightly distorted, which normally indicates that the cylinder has overheated.

A thorough examination of the oil system was carried out. The oil pump drive was intact, the pump was free to rotate, the filter was clean, and there were no blockages in any of the oilways or pipes. The amount of oil in the breather separator tank was not excessive. As far as could be ascertained, all the oil system components operated satisfactorily and the AAIB could identify no path for the oil to have been lost from the engine other than through the breather system or past the damaged No 3 piston.

In summary, the damage to the engine was consistent with a loss of lubrication, and cooling, which resulted in the pistons expanding and seizing in the cylinders.

Maintenance

Based on information from the owner, the accident flight met the description in Article 11 of the Air Navigation Order as being non-commercial. Therefore, it was acceptable for the aircraft to be used for public air displays while operating on a Permit to Fly and being maintained in an airworthy condition. The LAA offers advice to its members as to how this might be accomplished by the use of their Generic Maintenance Schedule to help owners produce a tailored maintenance schedule.

While the UL260iS engine had a recommended Time Between Overhaul (TBO) of 1,500 hours / 12 years, the manufacturer had introduced an initial TBO of 250 hours / 4 years for the aerobatic version of the engine, the UL260iSA.

The engine fitted to G-JINX had experienced several faults during its service history, which seemed to increase in frequency after the aircraft sustained an airborne propeller strike at 464 engine hours (Table 1). The maintenance to correct these faults was carried out by the owner, who was an LAA inspector and authorised to inspect this work and sign the Permit Maintenance Release.

The manufacturer informed the AAIB that the same design of piston was used in all of its high compression engines⁴ and it was only aware of the one occurrence of a piston cracking. On 5 March 2016 the manufacturer advised the owner of G-JINX to replace the pistons every 250 hours on aircraft used for aerobatic flights.

Footnote

⁴ Around 400 high compression engines had been delivered at the time of the accident.

Engine Hours	Date	Event
0	2009	The engine, manufactured as a UL260iS variant, was fitted to G-RIOT.
225	July 2010	A larger oil cooler was fitted to the engine by the owner.
286	Oct 2010	The engine was returned to the manufacture for conversion to the aerobatic version, UL260iSA.
292	July 2011	The engine was returned to the manufacturer for a new, modified, crankshaft to be fitted.
404	July 2012	The compressions on #3 and #4 cylinders were found to be low. The owner replaced both cylinder heads and the #3 cylinder.
464	Aug 2013	The engine was returned to the manufacturer for an inspection following an airborne propeller strike, while fitted to G-ZWIP, and then fitted to G-JINX.
483	May 2014	The #1 piston was found cracked. The piston and cylinder were replaced by owner.
530	July 2014	The owner found a suspect crack on the #4 piston. The #2, #3, #4 pistons and cylinders were replaced as a precaution by the owner. A subsequent inspection by the manufacturer found no evidence of a crack on the #4 piston.
530	July 2014	The engine was examined by the manufacturer following the suspected cracked piston.
533	Sep 2015	The oil temperature was reported to be high, but within limits, during a transit flight. The thermostat in the oil cooler was replaced.
609	July 16	The compressions on all four cylinders were found to be low. All four cylinder heads were replaced by the owner.
676	Nov 16	The compressions on the #1 and #3 cylinders were found to be low. Both cylinder heads were replaced by the owner.
683	May 17	The engine seized in flight while the aircraft was flying an aerobatic display.

Table 1

Service history of engine fitted to G-JINX

Recorded information

The EMS and EFIS were recovered from the aircraft and their memory downloaded. The EMS memory contained engine data such as oil temperature and pressure, engine rpm and cylinder head temperatures (CHT), recorded approximately every 10 seconds. The EFIS memory contained flight data such as altitude, airspeed, pitch attitude and heading, also recorded approximately every 10 seconds.

Figure 8 shows flight data from the EFIS starting as the aircraft descended to the start the display sequence and ending with the aircraft on the ground. EFIS times have been adjusted to align them with EMS. Figure 8 shows when the oil pressure dropped below 20 psi (generating an EMS low pressure warning – also plotted with engine rpm from EMS), the point in the flight where G-JINX performs a stall turn and when (based on timing from video evidence) it struck the ground 32 seconds later.

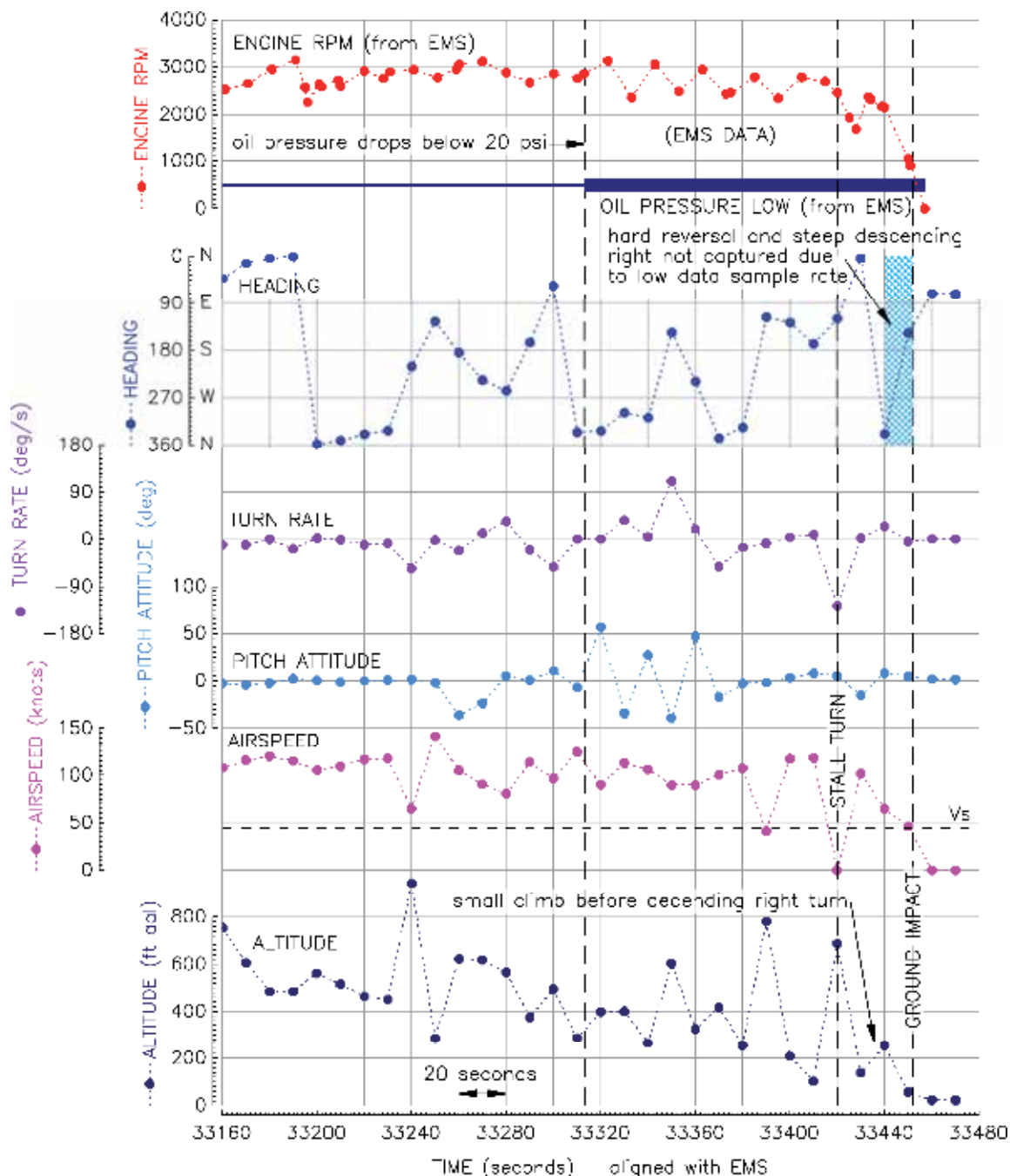

Figure 8
EFIS recorded flight data – accident flight

From video evidence, the right turn and descent to ground impact took 12 seconds, so are not evident in the EFIS data because of the low data sampling rate. However, the turn was through about 180° initially at 65 kt airspeed at about 250 ft aal. During the first half of the turn the bank angle was held at about 45° without significant height loss. The aircraft then began to descend as the bank angle increased and the nose dropped (Figure 9). At just under 60 ft aal the airspeed had reduced to 46 kt, after which the wings were levelled and the nose was raised to a slightly nose-down attitude at impact.



Figure 9

G-JINX shortly before ground impact
(Picture courtesy of Peter Thomas)

Figure 10 shows relevant engine data from the EMS. It indicates that the time between the increase in engine speed (time 33030, which corresponded to the start of the takeoff roll), and the low oil pressure warning was 4.8 minutes. During this period, as the oil temperature increased and the oil pressure decreased, engine rpm varied around 2,800 rpm (maximum continuous) and peaked briefly at 3,151 rpm. The CHTs also increased with the No 3 cylinder operating between 20 and 30°F hotter than the hottest of the other three cylinders (cylinder No 4). After approximately 4 minutes, the oil pressure had decreased to 30 psi. It then continued to decrease below 20 psi, generating the low pressure warning and reaching zero one minute later. The engine continued to rotate for a further 1.5 minutes.

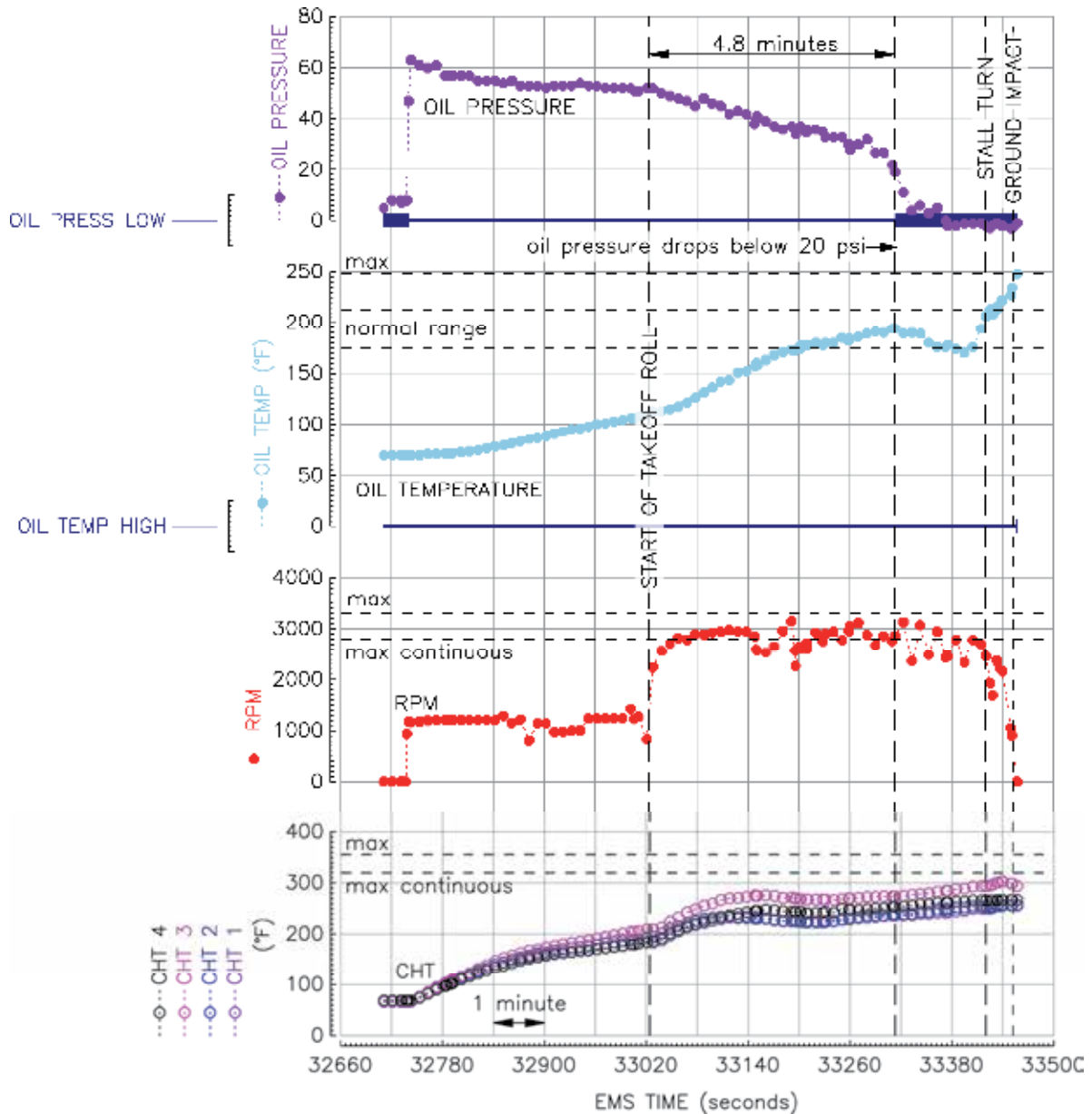

Figure 10
EMS recorded engine data - accident flight

Data from the accident flight was compared with data from a previous flight during which the aircraft flew the same display routine (Figure 11). The engine rpm, oil pressure, oil temperature and CHT profiles (including the hotter running No 3 cylinder) were similar on both flights until five minutes after the start of the takeoff roll, when both oil pressures decreased to below 30 psi. During the earlier display flight there was then a 2.5 minute period in which the oil pressure fluctuated between 16 and 30 psi, causing the low oil pressure warning to activate six times.

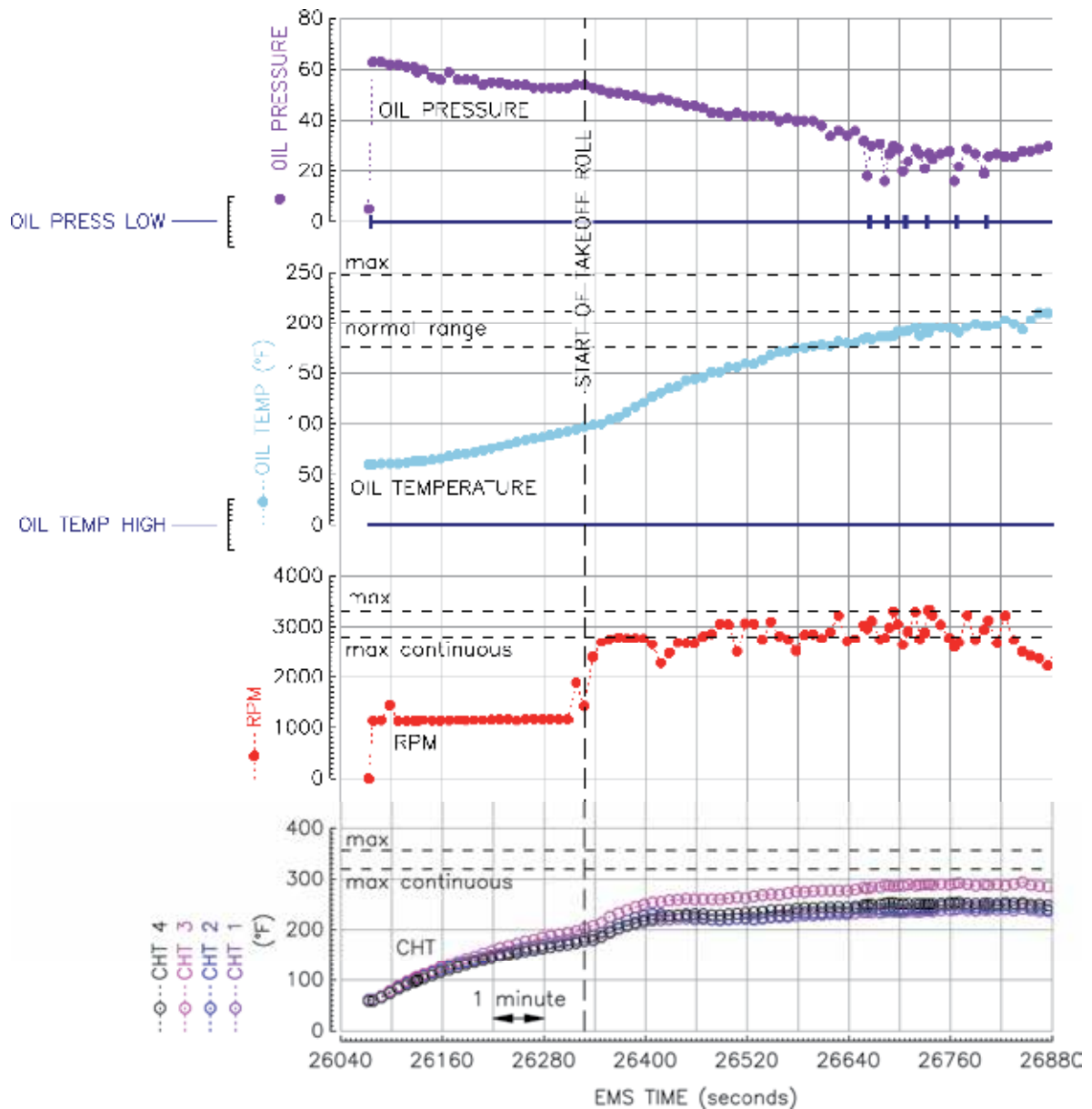

Figure 11

EMS recorded engine data - previous display flight

Engine data from the display flights was also compared with data from the aircraft when it was in cruising flight (Figure 12), during which oil pressure was 43(±2) psi and the oil temperature was stable at 175° F (the lower end of the normal range). The CHTs were also approximately 30° F cooler, with the No 3 cylinder again running hotter by about 20° F.

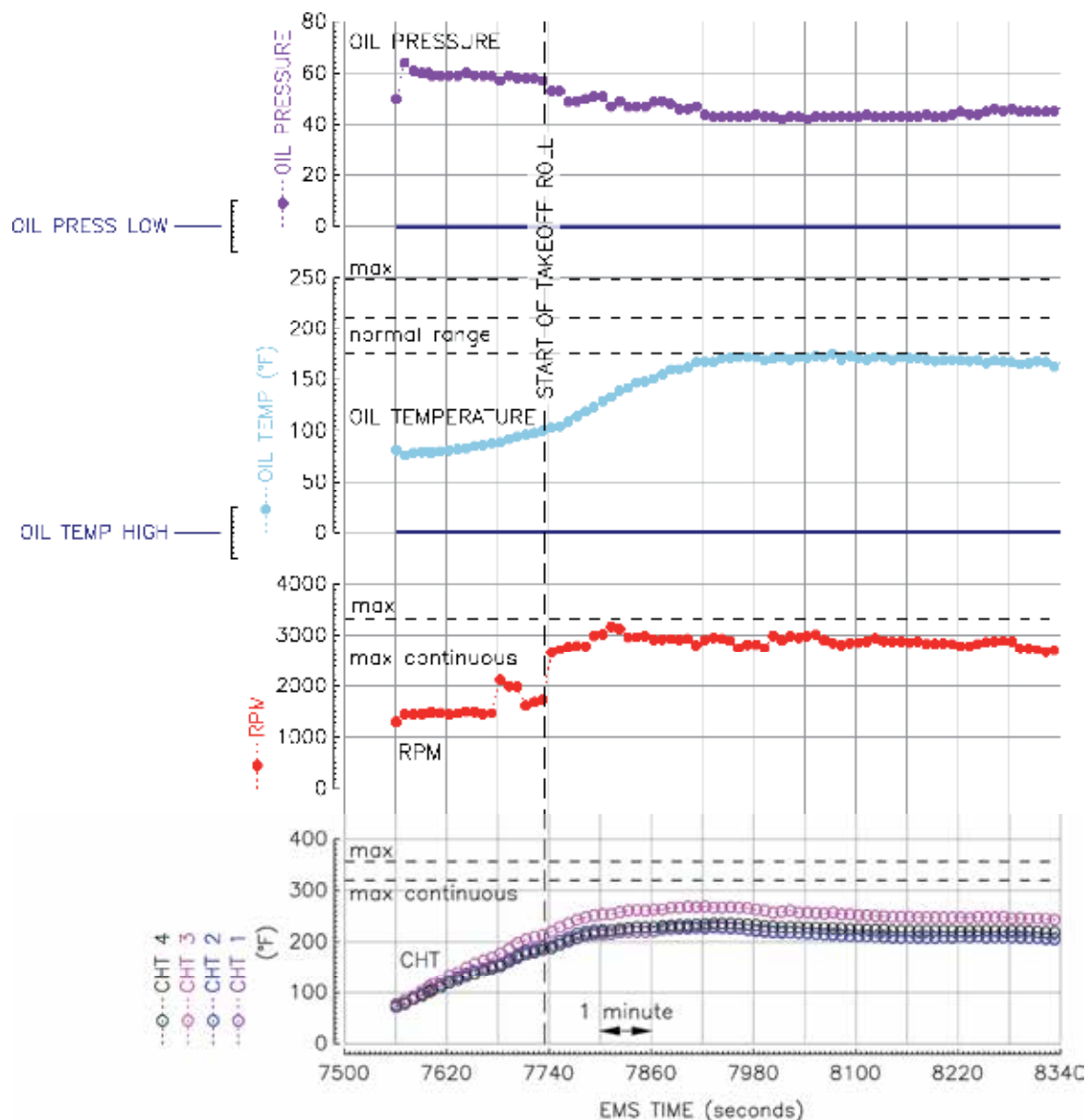

Figure 12

EMS recorded engine data - earlier cruise flight

In total the EMS recorded data for 13 flights. During the 12 flights prior to the accident flight, there were no indications that the engine had operated outside its approved limits.

Analysis

Operational aspects

The pilot of the accident aircraft commented that the relative lack of performance compared with the other aircraft, experienced during the first part of the display, was not unusual and that he had experienced comparable differences, with some difficulties staying in formation, before. Accordingly, this lack of performance alone did not provide an indication that the aircraft's engine was malfunctioning or about to fail.

Formation aerobatic flying involves a high level of concentration, in which the following aircraft pilot's attention must be focussed mainly outside the cockpit. The pilot did not notice the low oil pressure either during the display or the forced landing probably due to the limited internal visual cues and the absence of an audible warning.

When the pilot made the decision to discontinue the display the aircraft was at about 200 ft aal, downwind but close to Runway 18, and with limited opportunities to land ahead or to the left in the obstructed countryside beyond the aerodrome boundary. Having committed to landing on the runway, the pilot climbed initially and turned left to provide manoeuvring distance from the runway. He then flew a tight right turn, attempting to roll out on the runway's extended centreline without overflying the crowd line. However, due to the aircraft's low altitude and a crosswind from the west, he was unable to complete the manoeuvre. The aircraft flew through the runway centreline and struck the grass a few metres to the east of the runway whilst still descending.

The EFIS data indicates that 12 seconds before ground impact, as the aircraft began the turn to the right, the airspeed was approximately 65 kt, which is the speed stated in the flight manual to be flown in the event of '*Emergency landing with a stopped engine*'. During the first half of the turn this airspeed would have reduced as height was maintained. Halfway around the turn, as the bank angle increased and the nose dropped, the aircraft accelerated towards the ground and continued to do so until shortly before impact. However, the recorded speed at approximately 60 ft agl was 46 kt, at which there would have been limited opportunity to reduce the rate of descent, but he was able to level the wings before impact.

Engineering

General

The engineering evidence indicates that the engine operated normally until part way through the flying display when it seized due to a lack of lubrication and cooling.

A comparison of the data downloaded from the EMS with a video of the accident flight showed that the engine stopped approximately 7 minutes after the start of the takeoff run. There were no indications to warn the pilot that there was a problem with the engine, other than the low oil pressure discrete which operated for about 2.5 minutes before the engine stopped. All the other engine parameters were similar to those recorded during a previous display flight. There was no evidence from the previous 12 flights recorded in the EMS that the engine had operated outside its approved limits.

Engine seizure

The engine cylinder heads are mainly cooled by air, and the pistons and cylinders by oil. During an aerobatic flight the engine is often not only operating at a higher power setting, but the airflow into the engine will vary depending on the manoeuvre. While the engine oil system has been designed for aerobatic operations, the manufacturer advised that it might not be able to provide oil at the suction side of the pump during the full range of aerobatic manoeuvres, particularly when the engine experiences negative g. During the previous display flight the oil pressure reduced to 16 psi, which is considerably lower than the minimum of 40 psi seen in the cruise, but just above the minimum allowable operating pressure of 14.5 psi. A reduction in the oil supply might not initially be detected by an increase in the CHT or generate any engine warnings; however, the reduction in oil cooling could result in the pistons overheating, expanding, and with the lack of lubrication on the cylinder walls, starting to 'grab'. This could damage the pistons and ultimately cause the engine to seize.

While the pilot reported that there was sufficient oil in the engine at the start of the flight, the internal damage to the engine indicated that it had been operating for a short time without adequate oil cooling and lubrication. However, following the accident flight the oil system was assessed as serviceable and there was no evidence that oil could have been lost in flight other than through the exhaust system. Because oil was being injected into the exhaust system to produce smoke during the flying display, a loss of engine oil by this route would not be detected visually from the ground.

The amount of oil in the breather separator tank was not excessive; however, the possibility that one of the breather inlet valves stuck open, allowing crankcase pressure to blow the oil into the exhaust, could not be excluded. It is also possible that the oil leaked past the No 3 cylinder piston.

There was no evidence of cracking on the damaged No 3 cylinder piston; the damage was assessed as consistent with the piston overheating and expanding in the cylinder. It is possible that the damage to this piston accumulated over several flights, with a sudden failure, sufficient to cause the loss of oil, occurring during the accident flight. However, given the level of damage to the piston and cylinder it was not possible to establish if this was the case.

The maintenance history of the engine indicates that the engine had experienced numerous problems following the propeller strike that occurred at 464 engine hours. The No 3 cylinder had been operating at CHT approximately 20° F higher than the other cylinders, which the manufacturer advised was normal and within acceptable limits. It was not possible to determine if the other maintenance issues were coincidental or if they indicated a problem resulting from the propeller strike.

Survivability

The Twister aircraft is unusual among light aircraft in incorporating a cockpit safety cell of Kevlar composite construction. This feature, combined with the reclined seating position, energy absorbing cushions and the absence of sharp protrusions in the area of the head, probably contributed to the survivability of this accident.

Canopy opening

The emergency services reported difficulty in gaining access to the unconscious pilot as they did not know how to open the canopy and were concerned that they would further injure him if they tried to break it.

The canopy of the Silence Twister is not required to conform to the CS-VLA.

Safety actions

Engine

The engine manufacturer advised the AAIB that it would introduce processes to monitor the condition of UL260iSA engines in regular aerobatic use, including:

- Installing additional temperature sensors in the cylinder walls.
- Regularly downloading and reviewing the data from the Dynon EMS-D10.
- The return of the engine to the manufacturer after a number of aerobatic displays for a full strip and examination.

The manufacturer stated that it intended to issue an amendment to the engine manuals recommending that:

- The engine oil level should be between 4 and 4.5 litres prior to the start of an aerobatic display.
- A Teflon based additive should be added to the oil.
- Maintenance activities such as removing cylinder heads and replacing cylinders should be carried out by technicians approved by the manufacturer.

Canopy opening

Following the accident to G-JINX, the LAA amended its Technical Leaflet 2.11 'Aircraft Placards, Labels and Registration Marks' to include the following:

'When not otherwise obvious, the external and internal latches on cockpit doors and canopies should be clearly identified by labels or markings sufficiently prominent to be seen in an emergency. In the event of an accident, even a few seconds saved by first responders in rescuing the crew may be critical to a positive outcome, especially where there is the threat of fire. Each normal and emergency exit operating control should be red in colour. Suitable placards

should be near each control and should be designed to clearly indicate its method of operation, especially to a non-aviation person. Where any special procedure must be followed to gain entry, this should be described, for example 'to open canopy in an emergency, reach into cockpit through ventilator aperture and press red button. Canopy hinged on right hand side.'

Following the accident, the owner fixed labels to the outside of his other two Silence Twister aircraft explaining how the canopy is opened from the outside.

EMS audio alert

The aircraft owner stated he would consider enabling the EMS intercom audio alert function.

Conclusion

The engine operated normally until part way through the flying display when it seized due to a lack of lubrication and cooling. The available low oil pressure indications were not sufficient to alert the pilot before the engine seized. The subsequent forced landing resulted in impact sufficient to cause damage to the aircraft and serious injury to the pilot. Emergency responders were delayed by the absence of instructions, visible from outside the cockpit, explaining how the canopy could be opened. However, energy absorbing cushions and the safety cell construction of the cockpit contributed to the pilot's survival.

AAIB Correspondence Reports

These are reports on accidents and incidents which were not subject to a Field Investigation.

They are wholly, or largely, based on information provided by the aircraft commander in an Aircraft Accident Report Form (AARF) and in some cases additional information from other sources.

The accuracy of the information provided cannot be assured.

INCIDENT

Aircraft Type and Registration:	ATR 72-212A, EI-REM	
No & Type of Engines:	2 Pratt & Whitney PW127F turboprop engines	
Year of Manufacture:	2007 (Serial no: 760)	
Date & Time (UTC):	18 December 2017 at 1543 hrs	
Location:	Isle of Man Airport	
Type of Flight:	Commercial Air Transport (Passenger)	
Persons on Board:	Crew - 4	Passengers - 70
Injuries:	Crew - None	Passengers - None
Nature of Damage:	Light abrasion damage to tail bumper	
Commander's Licence:	Airline Transport Pilot's Licence	
Commander's Age:	52 years	
Commander's Flying Experience:	9,564 hours (of which 2,578 were on type) Last 90 days - 123 hours Last 28 days - 18 hours	
Information Source:	Aircraft Accident Report Form submitted by the pilot and subsequent AAIB enquiries	

Synopsis

During the landing flare the tail bumper on the underside of the rear fuselage made contact with the runway. The aircraft was inspected by engineers and no maintenance action was necessary for it to continue in service.

History of the flight

The aircraft was operating a scheduled passenger flight from Birmingham International Airport to the Isle of Man Airport, with the co-pilot as the handling pilot. The commander reported that during the final flare the aircraft pitch increased to around 6° and the speed reduced below the calculated approach speed. This resulted in a firm landing, during which the tail bumper contacted the ground. The aircraft flight management system recorded the vertical acceleration at touchdown as 1.31 g.

As the aircraft touched down, an air traffic controller observed sparks from under the rear fuselage. The controller reported that the subsequent rollout appeared normal. He requested a runway inspection to be carried out and for the flight crew to be informed. The flight crew were not aware that the aircraft tail had contacted the ground until advised by ATC.

The aircraft was inspected by engineers and the tail bumper on the lower rear fuselage was found to have suffered light abrasion damage. The damage was limited in its extent, such that no maintenance action was required for the aircraft to continue in service.

The operator reviewed the Flight Data Monitoring (FDM) data for the event, which identified that the aircraft pitch at touchdown was 6.94°. Guidance published by the aircraft manufacturer defines low, medium and high risk FDM event thresholds for '*High pitch at Touchdown*' on the ATR 72 as 6°, 7° and 8° respectively. These thresholds are reflected in the operator's FDM software, and the event was therefore determined to be in the low risk category.

The commander assessed that the tail strike occurred due to a combination of the downwards slope at the runway touch down zone, the slightly high pitch angle at touchdown, reducing airspeed and the high landing weight of the aircraft.

ACCIDENT

Aircraft Type and Registration:	Cessna 182T Skylane, G-LANS	
No & Type of Engines:	1 Lycoming IO-540-AB1A5 piston engine	
Year of Manufacture:	2007 (Serial no: 18281910)	
Date & Time (UTC):	9 December 2017 at 1215 hrs	
Location:	Bodmin Airfield, Cornwall	
Type of Flight:	Private	
Persons on Board:	Crew - 1	Passengers - 2
Injuries:	Crew - None	Passengers - None
Nature of Damage:	Damaged beyond economic repair.	
Commander's Licence:	Private Pilot's Licence	
Commander's Age:	61 years	
Commander's Flying Experience:	197 hours (of which 52 were on type) Last 90 days - 5 hours Last 28 days - 3 hours	
Information Source:	Aircraft Accident Report Form submitted by the pilot	

Synopsis

The approach was high and fast, and an intermediate flap setting was used to land on a relatively short runway, with a wet grass surface and a net downhill gradient. After touching down, further along the runway than planned, the pilot was unable to halt the aircraft before it overran the prepared surface and overturned onto a roadway. The pilot and his passengers used the doors to exit the aircraft without injury.

The pilot's licence was issued in July 2015 and, although his Single Engine Piston (SEP) rating had not been re-validated since then, he had maintained regular flying currency.

History of the flight

Before taking off from Oxford Airfield the pilot obtained information which indicated Runway 31 would be in use at Bodmin and that the grass surface was likely to be wet. The Landing Distance Available (LDA) on Runway 31 is 540 m and the pilot assessed this as sufficient (see *Aircraft performance*). He had visited Bodmin twice previously, the most recent of these visits being less than four months before the accident when he recorded three takeoffs and three landings on Runway 13, while accompanied by an instructor in a Cessna 172 aircraft.

In the vicinity of Bodmin, the pilot learnt that the surface wind was from 140° at 5 kt and that Runway 13 was in use. He was aware of a downhill gradient on Runway 13 but with an LDA

of 598 m, 54 m longer than that of Runway 31, he believed this was sufficient for a '*Short Field Landing*' (see *Aircraft information*), even though the aircraft was close to its maximum landing weight.

While joining the circuit for landing, the pilot orbited to make way for preceding traffic and in doing so he unintentionally allowed the aircraft to climb. Despite his best efforts to descend, he was aware of being higher than he should have been throughout the circuit, and was therefore above the ideal approach path when he established on final approach. He was also aware that the indicated airspeed of 75 kt was faster than intended and he noted afterwards that he only selected two stages of flap, so overlooked selecting the final stage of flap required for a '*Short Field Landing*'.

Prior to landing, the pilot realised that he would touchdown further along the runway than intended but he still thought there was adequate stopping distance. Following the accident he observed that, prior to the downhill gradient, the first section of the runway slopes up, creating a hump, and therefore the far end of the runway was not visible to him at this stage. His impression was that he touched down approximately one third of the way along the runway and he was surprised to learn afterwards that witnesses at the airfield assessed the point of touchdown as closer to three quarters of the available distance.

After touchdown, because of the wet grass, the pilot initially applied normal braking and by the time he realised there was only a short distance in which to stop, he judged that his speed was too slow to initiate a baulked landing and go-around. He then applied maximum braking, but felt the wheels skidding before the aircraft left the end of the runway at low speed. It overran down a grass bank and overturned onto a private road where it came to rest (Figure 1). The pilot secured the fuel and the electrics before he and his passengers opened the doors and escaped, without injury.



Figure 1

G-LANS inverted on the perimeter road following the accident.

Airfield surface conditions

The airfield operator reported that the grass on the runway had been cut the previous month and that although the surface was wet it was not soft or assessed as slippery. Later that day, once the runway had been reopened, several other aircraft landed uneventfully.

Aircraft information

The Pilot's Operating Handbook (POH) for the Cessna 182 suggests a final approach speed of 70-80 kt with flaps UP and 60-70 kt with flaps selected to FULL. Landings are permitted using any flap setting but no final approach speed is specified for landings with one of the two intermediate flap settings. The POH states that, for a '*Short Field Landing*' in smooth conditions, the approach speed should be 60 kt with flaps at FULL and that heavy braking is required immediately after the nosewheel has been lowered to the ground. To achieve maximum braking, the flaps must be retracted and the control wheel held fully back while applying maximum braking, without allowing the tyres to skid.

Aircraft performance

The POH includes tabulated performance data for landing using the '*Short Field*' technique. A distance of 416 m is required to come to a halt using maximum braking, from a height of 50 ft above a paved, level runway which is dry; the ground roll for such a runway is 183 m. No data is provided for landings using two stages of flap but with flaps UP the approach speed is to be 70 kt and both landing distances are to be increased by 40% for such landings. The only other data provided in the table is that the distances can be adjusted for the prevailing wind, with a 10% reduction for every 9 kt of headwind.

Advice on the calculation of takeoff and landing distances is provided in the UK Aeronautical Information Circular (AIC) 127/2006 '*Take Off, Climb and Landing Performance of Light Aeroplanes*'¹ and information from this is also included in the CAA's '*Skyway Code*' and in Safety Sense Leaflet 7c '*Aeroplane Performance*'. It is recommended that when certain variables are not available from the POH, then specific factors should be used, before applying a further '*General Safety Factor*' of 43% when landing. The AIC states:

'When a pilot planning a private flight chooses to accept aerodrome distances or climb performance less than that required for a public transport flight, he should recognise that the level of safety is lowered accordingly.'

The pilot of this aircraft considered only the ground roll requirement (183 m) in his pre-flight calculations for Runway 31 and he applied the CAA's factor of 35% for wet grass and then the CAA's additional safety factor of 43%. As a result he decided that he required a landing distance of 353 m and was satisfied because this was less than the available LDA of 540 m. When the runway changed to Runway 13 he was aware that he should allow an extra 10% to account for the downhill slope and was satisfied that the LDA of 598 m was sufficient.

Footnote

¹ UK AICs can be found on the NATS Aeronautical Information Service website.

After the accident, the pilot realised that by applying the ground roll figure as he did, he was assuming he would touch down at the beginning of the runway and that, even though he knew of no significant obstacles on the approach, it was unlikely he could achieve this. If he had assumed he would cross the runway threshold at 50 ft, then the required landing distance would have been 416 m, with an increase of 10% for the downhill slope and 35% for wet grass; thus his required landing distance for these circumstances was 618 m and this exceeded the LDA of 598 m, even before he applied the recommended general safety factor of 43%. In any case, the figures in the POH assume an approach speed of 60 kt and the use of FULL flap, whereas the approach was flown at 75 kt using only the second intermediate stage of flap.

Pilot information

The pilot's PPL included an SEP rating that was valid from the date he passed his skills test until 31 July 2017 but had not been revalidated. In order to revalidate his SEP rating the requirements of the EASA's Part-FCL.740.A have to be adhered to, meaning the pilot had to pass a proficiency check or meet certain currency criteria and have his licence signed accordingly, prior to the expiry date. The currency criteria are that he should have flown at least 12 hours in SEP aircraft in the 12 months preceding the expiry date (including at least 6 hours as pilot in command), to have performed 12 takeoffs and 12 landings and to have undertaken refresher training of at least one hour with a qualified instructor.

This pilot met the relevant currency criteria prior to the expiry of his rating and he had flown regularly with an instructor but he had not undertaken a refresher training detail and his licence had not been signed. According to the pilot this was an oversight because he had not studied the rating page of his licence and no reminders are sent concerning rating expiry. He noted that he had continued to maintain regular flying currency from the expiry of his rating until the date of the accident and he had even flown three circuits to Runway 13 at Bodmin with an instructor.

Following the accident, when he discovered the oversight with his licence, the pilot undertook refresher training before passing a proficiency check and renewing his SEP rating.

Pilot's assessment

The pilot reviewed his performance calculations and realised that if he had compared the landing distance required from 50 ft against the LDA, he would have found that Runway 13 was not suitable for his aircraft. In any case, the POH tables are primarily aimed at the '*Short Field Landing*' procedure which requires the use of FULL flap and then application of the prescribed maximum braking technique. In future he intends to revise such procedures regularly and to practise them with an instructor during refresher training, which he now views as being of great value, whether mandated or not.

Once he arrived overhead Bodmin he should have circled if necessary and taken time to evaluate the runway he planned to land on. In future, when visiting an airfield where he has little recent experience, he plans to acquaint himself with it by initially flying a "dummy" approach and go-around. Certainly when he realised he was too high on the approach and

that the airspeed was faster than intended, he should have gone around and flown a further circuit. He could have done this at any time before touchdown, but he continued because he believed he could stop before the end of the runway.

AAIB comment

In addition to recommending that, for planning purposes, light aircraft pilots apply the general landing safety factor of 43%, the CAA's Safety Sense Leaflet 7c includes the following 'Points to Note' in regard to landing:

'Landing distances quoted in the Pilot's Operating Handbook / Flight Manual assume the correct approach speed and technique is flown – a higher speed will add significantly to the distance required whilst a lower speed will erode stall margins.'

And:

'When landing at places where the length is not generous, make sure that you touch down on or very close to your aiming point (beware of displaced thresholds). If you've misjudged it, make an early decision to go-around – don't float halfway along the runway before deciding.'

Further advice is provided in Safety Sense Leaflet 1 'Good Airmanship' which states:

'Go-around if not solidly 'on' in the first third of the runway, or the first quarter if the surface is wet grass.'

The same leaflet recommends that private pilots undertake refresher flying at least once per year and suggests a number of exercises that should be practised during such a refresher flight.

ACCIDENT

Aircraft Type and Registration:	Piper PA-28-140 Cherokee, G-ATPN	
No & Type of Engines:	1 Lycoming O-320-E2A piston engine	
Year of Manufacture:	1966 (Serial no: 28-21899)	
Date & Time (UTC):	11 February 2018 at 1143 hrs	
Location:	Southend Airport, Essex	
Type of Flight:	Private	
Persons on Board:	Crew - 1	Passengers - 2
Injuries:	Crew - None	Passengers - None
Nature of Damage:	Extensive	
Commander's Licence:	Private Pilot's Licence	
Commander's Age:	44 years	
Commander's Flying Experience:	55 hours (of which 6 were on type) Last 90 days - 8 hours Last 28 days - 4 hours	
Information Source:	Aircraft Accident Report Form submitted by the pilot and further enquiries made by the AAIB	

Synopsis

Gusty wind conditions were experienced by the pilot during his first flight with passengers, which was also his first flight since the issue of his Private Pilot's Licence (PPL). He attempted to go around from a bounced landing, but the aircraft stalled and fell to the ground; impacting on a grass area to the south of the runway.

History of the flight*Flight preparation*

This was the pilot's first flight since the issue of his PPL and since completion of Piper PA-28 familiarisation training eight days previously; as a student pilot he had mostly flown Cessna 152s. The instructor who had completed the pilot's PA-28 training helped the pilot prepare for this flight, as it was his first flight with passengers and the first time he had flown with a rear-seat occupant. The pilot calculated that the aircraft's weight would be a little less than the Maximum Take Off Weight (MTOW) and that the Centre of Gravity (CG) would be near the centre of the permitted range.

The forecast wind was from 260° at 17 kt, with gusts to 32 kt, from the same direction, expected later in the day. Given the runway orientation of 235°, the pilot and the instructor were satisfied that the aircraft's crosswind limit of 17 kt for takeoff and landing would not be exceeded during the flight, and neither would the flying club's maximum wind limit of 30 kt for PPL hire. However, because turbulent conditions were expected, the instructor

recommended that the aircraft be landed using two stages of flap rather than three so that there would be no need to retract one stage of flap in the event of a go-around. The instructor recommended that the approach speed be increased by 5 mph, to 90 mph, to provide a margin of safety if gusts were encountered.

After an uneventful flight in the local area, the pilot returned to land on Runway 23 by way of a straight-in approach from a range of 12 nm. He described the conditions as “choppy”, especially once below 1,500 ft aal, with the strong, gusty wind leading to “a long and uncomfortable approach”. He set two stages of flap, as recommended, but forgot to add a safety increment to his airspeed and consequently his target speed was 85 mph. At a range of two nautical miles he received landing clearance from Air Traffic Control (ATC) and was informed the wind was from 280° at 19 kt¹.

Nearing the runway, the pilot thought he was below the ideal approach path but he continued because he felt he could still reach the displaced landing threshold. Prior to touchdown, he sensed a sudden gust of wind blowing the aircraft to the left and immediately after this the aircraft hit the runway and bounced. He attempted to go around and, as he added power, he transmitted on the radio that he was going around. While doing this he was aware the aircraft was pitching up and, although he did not notice if the stall warning light illuminated, he realised there was a danger of the aircraft stalling. Before he was able take any corrective action, the aircraft sank quickly and struck the grass to the left of the runway, causing all three landing gear legs to break. It skidded a few feet and turned right approximately 90° before coming to a halt facing towards the runway and resting on its left wing (Figure 1). The pilot and both passengers then escaped, unassisted, through the main door. The pilot reported that he turned the fuel selector to OFF and also tried to switch off the electric master switch before he got out, although he later realised he had misidentified another system switch as the electric master.



Figure 1

G-ATPN in its resting position approximately 95 m from the centreline of Runway 23

Footnote

¹ A wind of from 280° at 19 kt on Runway 23 would have given a crosswind component of 13 kt.

Recorded information

Recordings from the airfield's CCTV system indicated that the aircraft began to flare when approximately 20 ft aal and that it rolled left, and its rate of descent increased, before it contacted the runway having regained a wings-level attitude. The aircraft immediately bounced and climbed in a 25-30° nose-up attitude until it levelled for three seconds at approximately 40 ft aal, with a reduced nose-up attitude at a groundspeed that seemed slower than it should have been. After turning left a few degrees the aircraft began to sink and, as it dropped towards the grass area south of the displaced runway threshold, its rate of descent increased and the right wing dropped. Ten seconds after the bounced touchdown it struck the ground hard, skidded forward a few feet and slewed right before coming to rest.

The occupants of the aircraft were seen to walk clear of the aircraft 35 seconds later, and one minute after that the Rescue and Fire Fighting Service reached the scene.

Aircraft operator's comments

The instructor who completed the pilot's PA-28 training reported that the four approaches and landings which the pilot performed with him were "good" and this reflected the level of landing competency recorded in the pilot's previous training notes. He had apparently landed without difficulty with a crosswind of 12 kt from the right and in gusty conditions.

The flying club which operated the aircraft noted this was the pilot's first flight with an aircraft close to the MTOW and with a rear seat passenger. He would have had to overcome a tendency for the aircraft to pitch nose-up because the CG was further aft than he had previously experienced. The flying club is considering introducing a requirement for newly qualified PPL holders to practice flying an aircraft at its MTOW with an instructor, before they fly solo with passengers.

Pilot's comments

Following the accident, the pilot thought he should have tried to gain more experience in various wind conditions before he carried passengers. He observed that because he flew a long final approach in turbulent conditions he had felt "unnerved" by the time he reached the airfield. He assessed that he should have gone around earlier, once he appreciated that he had diverged from his ideal approach path. When he did attempt to go-around he should have concentrated on flying the aircraft rather than trying to communicate with ATC.

Although he did not recall applying back pressure on the control column to pitch the nose-up excessively, he realised he should have adopted an attitude during the go-around which allowed the speed to increase, and had he done this the aircraft would not have stalled. He was also aware that he should have applied more right rudder pedal to keep the aircraft straight as he increased power. Before flying solo again he intends to practise go-arounds with an instructor and would like to do this from scenarios close to the runway.

ACCIDENT

Aircraft Type and Registration:	Piper PA-28-161 Cherokee Warrior II, G-BSXB	
No & Type of Engines:	1 Lycoming O-320-D3G piston engine	
Year of Manufacture:	1984 (Serial no: 28-8416125)	
Date & Time (UTC):	16 November 2017 at 1141 hrs	
Location:	Wolverhampton (Halfpenny Green) Airport, Staffordshire	
Type of Flight:	Private	
Persons on Board:	Crew - 2	Passengers - None
Injuries:	Crew - 2 (Minor)	Passengers - N/A
Nature of Damage:	Extensive	
Commander's Licence:	Private Pilot's Licence	
Commander's Age:	73 years	
Commander's Flying Experience:	925 hours (of which 755 were on type) Last 90 days - 6 hours Last 28 days - 3 hours	
Information Source:	Aircraft Accident Report Form submitted by the pilot and further enquiries by the AAIB	

Synopsis

An approaching weather front caused a sudden change of wind direction which the pilot had not anticipated and the resulting tailwind led to a touchdown more than halfway along the runway. The pilot encountered difficulty reducing the aircraft's speed and made a late attempt to abort the landing and take off again. However, the aircraft struck the airfield boundary hedge, crossed a road and hit a second hedge before coming to rest with the left wing detached from the fuselage.

History of the flight

When the pilot departed Wolverhampton (Halfpenny Green) Airport he was aware there was a cold weather front to the northwest which was moving towards the airfield. Before taking off, from the asphalt Runway 16, the Flight Information Service Officer (FISO) informed him by radio that the estimated¹ wind was from 230° at 8 kt. After leaving the circuit area, the pilot encountered deteriorating weather conditions including low cloud, rain, reduced visibility and turbulence. Approximately 20 minutes after his departure, he told the FISO he was returning to the airfield and was advised that Runway 16 was still in use.

Footnote

¹ The airfield anemometer was unserviceable so the FISO primarily referred to a nearby windsock to estimate the wind.

The pilot re-joined the circuit for Runway 16, which has a landing distance available of 858 m, and made a radio call stating he was on the downwind leg. This call was acknowledged by the FISO who asked the pilot to report on final approach. Less than two minutes later, the FISO noticed the wind had veered and called the aircraft. In response the pilot announced he was on final approach, so the FISO told him there was a tailwind on this approach because he estimated the wind was now from 300° at 10 kt. While transmitting this message, the FISO spotted the aircraft at approximately 10 ft aal, further than halfway along Runway 16. He watched as the aircraft touched down adjacent to the Precision Approach Path Indicators (PAPIs) for Runway 34 which are situated 393 m from the stop-end of Runway 16.

According to the pilot, the aircraft seemed reluctant to descend while on final approach, but he did not remember hearing the FISO inform him of a tailwind. He stated that the visibility had reduced because of rain, but he appreciated that he was still airborne when more than halfway along Runway 16. His passenger, a former flight instructor, twice suggested that he went around but the pilot continued because he still believed he had sufficient runway available to complete a landing.

After touching down, the pilot encountered difficulty decelerating due to the wet surface and the tailwind so, when he realised the end of the runway was approaching, he increased power and attempted to go around. Once airborne, he was aware of the left wing dipping, probably because he had not applied sufficient right rudder to counteract the increased engine torque, and the left wingtip then struck a hedge at the airfield boundary. This caused the aircraft to lose height as it crossed a public road and before impacting a second hedge with a co-located fence, on the south side of the road. As a result of the second collision the left wing detached, and the aircraft spun around and stopped abruptly a few metres into a grass field (Figure 1).



Figure 1

G-BSXB, with its left wing detached, facing back towards the second hedge

The airfield crash alarm had been activated by the FISO when the aircraft was still approximately 100 m from the stop-end of Runway 16, because he realised an accident

was imminent. He observed the aircraft adopt a nose-up attitude and cross the 46 m grass area beyond the runway, before striking the boundary hedge, which is approximately two meters high, and disappear from his view.

When the airfield Rescue and Fire Fighting Service (RFFS) arrived, the pilot and his passenger were making their own way out of the aircraft, although both then required treatment for minor head injuries. The RFFS noted that the aircraft's magneto key had been withdrawn but that the electric master switch and the fuel pump were set to ON, while the throttle remained at its maximum open setting, so these controls were all made safe.

Meteorology

The Met Office's weather chart (F215) for the forecast weather below 10,000 ft on the day of the accident, indicated that a cold front was moving across the British Isles in a southeasterly direction. This front contained isolated and embedded cumulonimbus clouds and the chart depicted that it would pass over the Wolverhampton area during the late morning.

Birmingham International Airport, approximately 19 nm to the southeast, is the nearest airfield to Wolverhampton for which a Terminal Aerodrome Forecast (TAF) is produced. The Birmingham TAF that was current before the flight commenced, suggested the wind direction at Birmingham would change from southwesterly to northwesterly between 1100 hrs and 1300 hrs. The TAF also indicated the possibility of the visibility and cloudbase at Birmingham reducing temporarily, with associated rain and with gusts of wind up to 25 kt in strength.

A senior flight instructor who was present at Wolverhampton that morning, stated that the weather was deteriorating, the sky was darkening and it was drizzling when the aircraft took off. Later, when he heard the crash alarm, he noted that it was raining and estimated from the windsock that the wind was from 340° at 15 kt. He observed that the sky cleared and the rain stopped a few minutes later. He also commented that, given the position of the windsock, a pilot approaching Runway 16 might find it difficult to discern that it was aligned in the reciprocal direction to that expected.

A helicopter instructor, who did not witness the accident but who was flying in the vicinity when it occurred, was aware of the wind changing direction quickly from southwesterly to northwesterly. In association with this, he saw the windsock indicate an increase in wind strength, and he believed these change were due to a weather "cell" located to the west of the airfield.

AAIB Comment

The CAA's '*Skyway Code*' (CAP 1535) reminds pilots that they are required to consider the meteorological situation before commencing a flight. A section titled '*Pre-Flight Preparation*', informs pilots that the Met Office is the main source of aviation weather information in the UK and the document provides detailed guidance to help them interpret charts and codes. It stresses that pilots should have a good working knowledge of the

conditions associated with common weather features such as warm and cold fronts. The Met Office also provides a '*Pilot Resource Portal*'² which aims to ensure pilots can make best use of the available forecasts and this compliments the '*General Aviation Weather Briefing Portal*'³.

One hazard that can be associated with passage of a cold front is windshear. The UK '*Aeronautical Information Circular 84/2008 (Pink 150)*' provides guidance relating to low altitude windshear and how it can effect an aircraft in flight. This circular can be downloaded from the NATS Aeronautical Information Service website.

CAA Safety Sense Leaflets (SSL) are a further source of useful guidance material for pilots and can be downloaded from the '*Publications*' section of the CAA's website. SSL 1e '*Good Airmanship*' addresses many aspects of general aviation flight and tells pilots to:

'Get an aviation weather forecast, heed what it says and make a carefully reasoned GO / NO-GO decision.'

In the same document there is advice concerning landings which states a pilot should:

'Go-around if not solidly 'on' in the first third of the runway, or the first quarter if the surface is wet grass.'

Footnote

² See <https://www.metoffice.gov.uk/aviation/ga/pilot-resource-portal>

³ See <https://www.metoffice.gov.uk/aviation/ga-briefing-services>

ACCIDENT

Aircraft Type and Registration:	Piper PA-28-161 Cherokee Warrior III, G-WARY	
No & Type of Engines:	1 Lycoming O-320-D3G piston engine	
Year of Manufacture:	1997 (Serial no: 2842024)	
Date & Time (UTC):	16 February 2018 at 0940 hrs	
Location:	Shoreham Airport, West Sussex	
Type of Flight:	Private	
Persons on Board:	Crew - 1	Passengers - None
Injuries:	Crew - None	Passengers - N/A
Nature of Damage:	G-WARY wing tip and lower skin damaged, engine shock-load. G-WARZ, wing tip and major disruption to rear fuselage	
Commander's Licence:	Private Pilot's Licence	
Commander's Age:	77 years	
Commander's Flying Experience:	560 hours (of which 475 were on type) Last 90 days - 14 hours Last 28 days - 1 hour	
Information Source:	Aircraft Accident Report Form submitted by the pilot and further inquiries made by the AAIB	

Synopsis

G-WARY had been parked to the right of a similar PA-28, G-WARZ, and was being taxied by its pilot, occupying the right seat, to the fuel pumps in preparation for a planned cross-country flight. The aircraft (G-WARY) moved forward and the pilot commenced a left turn but, rather than straighten up after having turned through 90° as he intended, G-WARY continued its turn, colliding and becoming interlocked with the parked G-WARZ, causing it severe damage. The pilot was uninjured and considers that he may have applied more left braking than he anticipated. However, his position in the right seat, and therefore his fluency with the throttle and the position of his feet on the rudder pedals, appear to have been the factors in the loss of control of the aircraft.

Sequence of events

The pilot was familiar with the aircraft and the layout of the apron at Shoreham Airport. His intention was to taxi from where G-WARY was parked on the line, next to G-WARZ, to the fuel pumps. As the aircraft moved forward he applied left brake and a small amount of power, carrying out a 90° left turn. He was about to straighten up when, to his surprise, the aircraft continued turning to the left. Before he could close the throttle and apply the brakes, the aircraft left wing caught and drove under the left wing of G-WARZ, turning G-WARY through 180°. It then continued forwards towards the left side of the stationary G-WARZ

until the turning propeller penetrated its rear fuselage and brought everything to a stop. The aircraft were now interlocked and substantial damage was caused to G-WARZ, as shown in Figures 1 and 2.



Figure 1



Figure 2

G-WARY and G-WARZ interlocked
(Pictures courtesy of Shoreham Airport)

Pilot's and instructor's observations

The pilot considered that he may have inadvertently applied more left brake than was required or intended and, before he had a chance to close the throttle, G-WARY had collided with G-WARZ. Shortly after the accident the pilot flew with an instructor. As part of the flight the instructor observed him taxiing the aircraft to understand how the accident had occurred. The instructor noticed that the pilot's foot positioning on the pedals, with his heels resting on the cockpit floor, was not ideal for positive and effective brake control. The pilot considers that this, and his unfamiliarity with operating the aircraft from the right seat, were significant factors.

AAIB comment

The pilot was the sole occupant of the aircraft and was in the right seat. In this type of aircraft it is usual for the pilot in command (PIC) to occupy the left seat and operate the throttle with the right hand. The pilot had 475 hours as PIC on type and would be more used to controlling the throttle from the left seat. The pilot's belief that he applied more left brake than was required could also mean that there was insufficient right braking applied, leading to an imbalance. This was probably due to a combination of his seating position and the position of his feet on the rudder pedals. It is therefore likely that these aspects affected his fluency with the throttle and brakes and were significant causal factors during the rapid onset of the collision.

ACCIDENT

Aircraft Type and Registration:	Piper PA-28-181 Cherokee Archer II, G-BSIZ	
No & Type of Engines:	1 Lycoming O-360-A4M piston engine	
Year of Manufacture:	1979 (Serial no: 28-7990377)	
Date & Time (UTC):	7 January 2018 at 1140 hrs	
Location:	Near Elstree Aerodrome, Hertfordshire	
Type of Flight:	Training	
Persons on Board:	Crew - 2	Passengers - None
Injuries:	Crew - None	Passengers - N/A
Nature of Damage:	Extensive	
Commander's Licence:	Commercial Pilot's Licence	
Commander's Age:	33 years	
Commander's Flying Experience:	535 hours (of which 327 were on type) Last 90 days - 66 hours Last 28 days - 44 hours	
Information Source:	Aircraft Accident Report Form submitted by the pilot	

Synopsis

Following a training flight, involving forced landing practice, the aircraft descended in preparation for landing at Elstree Aerodrome. When the student pilot advanced the throttle, the engine power did not increase, and the instructor took control and landed the aircraft in a field to the south of the airfield.

History of the flight

The aircraft departed from Elstree at 1010 hrs and operated in an area some 15 nm to the northwest of the airfield, at altitudes up to 3,500 ft amsl, while the student pilot practised forced landing procedures. Both the instructor and the student stated that they remained well clear of the few clouds they saw above them and that carburettor heat was applied regularly throughout the exercise. During the transit back towards Elstree, carburettor heat was de-selected when the aircraft was approximately 7 nm from the airfield at 1,700 ft aal. The carburettor heat was selected on again before the throttle was reduced to idle in preparation for a descent to 1,000 ft aal, the circuit altitude. During this descent the aircraft routed overhead the airfield from north to south, to join the right-hand circuit for Runway 08.

After inadvertently descending to 900 ft aal, the student advanced the throttle to initiate a climb, but the engine did not respond. He immediately checked that all fuel and electric indications were normal and then both he and instructor made further unsuccessful attempts

to increase power, before the instructor took over control of the aircraft and manoeuvred it towards a field one mile south of Elstree. The instructor actioned the engine failure checklist items but no power increase was apparent so, at approximately 500 ft agl, he transmitted a MAYDAY call and completed the checklist items for a forced landing.

The aircraft touched down in a wet and muddy grass field, on all three wheels, but the nosewheel then lifted-off for a short distance before contacting the ground a second time and detaching. Consequently the propeller and the nose of the aircraft dug in and caused the aircraft to turn left through approximately 90°, while the right wing struck the ground and incurred severe damage. Once the aircraft came to rest, the uninjured occupants exited the aircraft and phoned the airfield to report what had happened.

Aircraft examination

Following an examination of the aircraft, its owner reported that no engine fault was found and that both fuel tanks still contained fuel before the aircraft was recovered. Carburettor icing was suggested as a possible cause for the engine problem, even though the instructor reported that carburettor heat was used in accordance with the aircraft manufacturer's procedures.

AAIB comment

Detailed guidance concerning all forms of engine induction icing is provided in UK 'Aeronautical Information Circular 077/2009 (Pink 161)' which is available on the NATS Aeronautical Information Service website. Relevant information can also be found in the CAA's Safety Sense Leaflet 14 'Piston Engine Icing' which is similar to the EASA's European General Aviation Safety Team's Safety Promotion Leaflet GA 5.

Met Office records indicate that the outside air temperature while the aircraft was returning towards Elstree was approximately 0°C and that the dew point was in the region of 0.5°C less than this. According to a chart which can be viewed in the aforementioned documents, this would have placed the aircraft at risk of serious icing at any power setting.

Loss of engine power has been attributed to carburettor icing in several previous AAIB reports, even when the carburettor heat has apparently been used as recommended, for example G-BZDA in AAIB Bulletin 11/2016 and G-LUSH in AAIB Bulletin 9/2017.

ACCIDENT

Aircraft Type and Registration:	Rotorway Executive 162F, G-CCMU	
No & Type of Engines:	1 Rotorway RI 162F piston engine	
Year of Manufacture:	2004 (Serial no: 6720)	
Date & Time (UTC):	26 October 2017 at 1650 hrs	
Location:	Salterford Farm, Nottinghamshire	
Type of Flight:	Private	
Persons on Board:	Crew - 1	Passengers - 1
Injuries:	Crew - None	Passengers - 1 (Minor)
Nature of Damage:	Extensive	
Commander's Licence:	Private Pilot's Licence	
Commander's Age:	47 years	
Commander's Flying Experience:	60 hours (of which 17 were on type) Last 90 days - 8 hours Last 28 days - 2 hours	
Information Source:	Aircraft Accident Report Form submitted by the pilot	

The pilot was returning after a local flight and as he turned onto finals, at approximately 40 to 50 ft, the helicopter yawed to the left. He attempted to correct with right pedal but the turn sped up quickly. The pilot noticed he was losing height and raised the collective lever, but he was unable to stop the descent. The helicopter spun two or three times before striking the grass surface with skids level. It then rolled over, causing extensive damage (Figure 1). Both occupants were restrained by their harnesses and could exit the aircraft through the broken windscreen.



Figure 1
G-CCMU after the accident

The pilot commented that he had allowed his airspeed to reduce excessively during his approach and may have inadvertently entered a hover out of ground effect. This requires a collective input and a significant increase in power. If insufficient engine power is applied, the rotor speed will drop. This can reduce tail rotor effectiveness and is likely to have resulted in the spin.

The Rotorways Executive 162F pilot operating handbook prohibits out of ground effect hovers for all pilots under 150 hours.

The pilot was relatively inexperienced on helicopters and commented that he may not have identified the situation as it unfolded.

ACCIDENT

Aircraft Type and Registration:	Dynamic WT9 UK, G-RMHE	
No & Type of Engines:	1 Rotax 912-UL piston engine	
Year of Manufacture:	2007 (Serial no: DY155)	
Date & Time (UTC):	4 February 2018 at 1240 hrs	
Location:	Lane Farm Airfield, Powys	
Type of Flight:	Private	
Persons on Board:	Crew - 1	Passengers - None
Injuries:	Crew - None	Passengers - N/A
Nature of Damage:	Damage to nose gear, propeller and engine cowling	
Commander's Licence:	National Private Pilot's Licence	
Commander's Age:	65 years	
Commander's Flying Experience:	631 hours (of which 7 were on type) Last 90 days - 14 hours Last 28 days - 5 hours	
Information Source:	Aircraft Accident Report Form submitted by the pilot	

The Dynamic WT9 is a low-wing, all-composite, fixed-wing microlight, with side-by-side seating.

After carrying out a few circuits at his home airfield the pilot flew to Lane Farm, which has a 730 m grass runway, for some practice circuits. On final approach the pilot thought he was "a bit high" so he used a sideslip to lose some height. When crossing the runway threshold, he noted that he was "a little too fast" but thought that he could slow down. As the mainwheels touched down the aircraft bounced back into the air by a few feet. The nose dropped and the nosewheel struck the ground causing it to collapse. The propeller also struck the ground and the engine stopped. The pilot was able to exit the aircraft without any difficulty.

ACCIDENT

Aircraft Type and Registration:	Ikarus C42 FB100 Bravo, G-OSPH	
No & Type of Engines:	1 Rotax 912 ULS piston engine	
Year of Manufacture:	2012 (Serial no: 1205-7202)	
Date & Time (UTC):	16 February 2018 at 1140 hrs	
Location:	Membury Airfield, Berkshire	
Type of Flight:	Training	
Persons on Board:	Crew - 1	Passengers - None
Injuries:	Crew - None	Passengers - N/A
Nature of Damage:	Damage to propeller, nose landing gear, left and right wings and right tailplane. Engine shock-loaded	
Commander's Licence:	Student	
Commander's Age:	47 years	
Commander's Flying Experience:	79 hours (of which all were on type) Last 90 days - 7 hours Last 28 days - 3 hours	
Information Source:	Aircraft Accident Report Form submitted by the pilot	

The student pilot was practising solo circuits with glide approaches to Runway 23 at Membury Airfield. Having completed three circuits successfully, the pilot reported that following a normal touchdown on the fourth circuit, a gust of wind caused the aircraft to become airborne again. The pilot over-corrected in pitch and the aircraft struck the runway on the nosewheel, causing a series of bounces. The pilot attempted to go around but the aircraft departed the runway to the left and struck trees adjacent to the runway. The pilot stated that an earlier decision to go around may have prevented the accident.

ACCIDENT

Aircraft Type and Registration:	Jabiru UL-450, G-JAXS	
No & Type of Engines:	1 Jabiru 2200A piston engine	
Year of Manufacture:	2001 (Serial no: PFA 274A-13548)	
Date & Time (UTC):	5 February 2018 at 1410 hrs	
Location:	Welshpool Airport, Powys	
Type of Flight:	Private	
Persons on Board:	Crew - 1	Passengers - None
Injuries:	Crew - None	Passengers - N/A
Nature of Damage:	Left strut buckled and fuselage attachment plate distorted. Propeller damaged and engine possibly shock-loaded	
Commander's Licence:	National Private Pilot's Licence	
Commander's Age:	54 years	
Commander's Flying Experience:	114 hours (of which 2 were on type) Last 90 days - 1 hour Last 28 days - 0 hours	
Information Source:	Aircraft Accident Report Form submitted by the pilot	

Synopsis

As the aircraft began to accelerate for takeoff it veered quickly left, possibly due to a binding wheel. It departed the runway, traversed an adjacent grass area and struck the airfield boundary hedge.

History of the flight

Prior to this flight, the pilot had accrued 19 hours on three-axis microlight aircraft, while undertaking differences training from flex-wing microlights. This training had been completed during his last flight 89 days previously, and 7 days after he had gained his only experience flying the Jabiru UL-450.

Two days before the accident, the pilot changed the inner tube on the left mainwheel because the tyre had deflated. However, a flight instructor subsequently moved the aircraft and thought the brake on the left mainwheel was binding, so passed a message to the pilot. On the day of the accident the pilot checked the aircraft but identified no issues with the wheelbrakes¹ before start-up or while taxiing approximately 1,000 m to the threshold of the asphalt Runway 04.

Footnote

¹ The aircraft is fitted with drum brakes on both mainwheels and they are activated together, via a single master cylinder, when a hand-operated lever is pulled.

The pilot reported that, when he increased the power to begin his takeoff, he applied sufficient right rudder pedal to counteract the torque effect from the propeller. However, as the aircraft began to accelerate, it veered quickly to the left and he was unable to keep it on the runway, which is 18 m wide. He switched off the engine but could not prevent the aircraft from running approximately 46 m across an adjacent grass area and colliding with a hedge. The aircraft came to rest in the hedgerow and the pilot then closed the fuel supply before escaping through the passenger door, as his own door was blocked (Figure 1).



Figure 1

G-JAXS enmeshed in the airfield boundary hedge

After the accident a mark in the grass suggested that the left wheel was not rotating when the aircraft departed the runway. This may indicate that the left wheel was subject to an intermittent fault which caused it to bind, because no wheelbrake issues or defects were apparent when the aircraft was inspected at a maintenance facility.

In hindsight, the pilot considered it possible that a more experienced pilot might have managed to bring the aircraft to a halt without hitting the hedge. He realised, given the period that had elapsed since his last flight, he should have considered asking an instructor to accompany him for this flight.

ACCIDENT

Aircraft Type and Registration:	Pegasus Quik GT450, G-PUGZ	
No & Type of Engines:	1 Rotax 912ULS piston engine	
Year of Manufacture:	2012 (Serial no: 8639)	
Date & Time (UTC):	17 February 2018 at 1500 hrs	
Location:	Little Gransden Airfield, Cambridgeshire	
Type of Flight:	Private	
Persons on Board:	Crew - 1	Passengers - None
Injuries:	Crew - None	Passengers - N/A
Nature of Damage:	Extensive	
Commander's Licence:	National Private Pilot's Licence	
Commander's Age:	52 years	
Commander's Flying Experience:	2,124 hours (of which 2,052 were on type) Last 90 days - 18 hours Last 28 days - 8 hours	
Information Source:	Aircraft Accident Report Form submitted by the pilot	

Synopsis

While landing with a crosswind, the pilot encountered an unexpected downdraught and he was unable to prevent the aircraft striking the ground and departing the runway at the downwind edge.

History of the flight

The pilot, an experienced flexwing instructor, approached Runway 28 at Little Gransden Airfield with a southerly wind of 5-7 kt. He aimed to land one third of the way along the 810 m grass runway to avoid rotor effect in the lee of the trees and buildings situated south of the threshold area. However, as the pilot completed his round-out, at a height of approximately 3 ft, the aircraft unexpectedly encountered a strong downdraught and he was unable to initiate a go-around before the nose of the aircraft hit the ground.

On impact, the nose landing gear collapsed and the engine ran to its maximum speed due, it was later discovered, to damage inflicted to the foot throttle mechanism. As the aircraft skidded forward and right, the pilot removed one hand from the control bar to turn off the magneto switches, situated on his right side. This took a few seconds to accomplish because the aircraft was bumping against the ground, the switches are small and he was wearing gloves. During this time, because he had only one hand on the control bar, he was unable to prevent the wing from striking the ground.

The aircraft departed the northern edge of the runway and the nose cone dug into soft mud, causing the main wheels to lift off the ground momentarily. The aircraft settled upright, so the pilot had no difficulty climbing out, but he believes that if he had not managed to turn off the magnetos the power of the engine would have flipped the aircraft upside down.

ACCIDENT

Aircraft Type and Registration:	Rans S6-ES Coyote II, G-BYSN	
No & Type of Engines:	1 Rotax 912-UL piston engine	
Year of Manufacture:	1999 (Serial no: PFA 204-13459)	
Date & Time (UTC):	8 October 2017 at 0850 hrs	
Location:	Over Farm, Tewkesbury, Gloucestershire	
Type of Flight:	Private	
Persons on Board:	Crew - 1	Passengers - 1
Injuries:	Crew - None	Passengers - None
Nature of Damage:	Extensive fire damage	
Commander's Licence:	Private Pilot's Licence	
Commander's Age:	66 years	
Commander's Flying Experience:	499 hours (of which 36 were on type) Last 90 days - 12 hours Last 28 days - 12 hours	
Information Source:	Aircraft Accident Report Form submitted by the pilot	

The aircraft, with the pilot and a passenger aboard, was taking off from a grass strip near Over, Gloucestershire. There was a light crosswind from the left and the grass was damp. Pre-flight inspection and engine power checks were normal.

On takeoff the aircraft accelerated normally and at approximately 42 mph IAS the pilot initiated rotation. He described the rotation as "slightly heavier" than usual. As the aircraft lifted off, the pilot felt the aircraft lose momentum and turn markedly to the left, taking the aircraft over the ploughed field to the left of the runway. The pilot, not wanting to put the nose down over the ploughed field, applied full right rudder to turn back towards the runway but as he did this the right wing dropped and the wing tip contacted the ground. The aircraft came to rest on the left side of the runway and fire was seen at the front of the engine cowling. The pilot and passenger exited the aircraft unaided with only minor injuries. The aircraft was substantially damaged by the fire.

The pilot believes that the engine suffered a power loss during rotation which led to the left wing stall, and subsequently the application of the right rudder then caused the right wing to stall. Due to the fire damage it was not possible to determine why the engine lost power.

The aircraft was approximately 4% above its maximum takeoff weight. This would have reduced the stall margin giving the pilot very little time to react to any loss of power.

Miscellaneous

This section contains Addenda, Corrections and a list of the ten most recent Aircraft Accident ('Formal') Reports published by the AAIB.

The complete reports can be downloaded from the AAIB website (www.aaib.gov.uk).

TEN MOST RECENTLY PUBLISHED FORMAL REPORTS ISSUED BY THE AIR ACCIDENTS INVESTIGATION BRANCH

- | | |
|--|--|
| <p>1/2014 Airbus A330-343, G-VSXY
at London Gatwick Airport
on 16 April 2012.
Published February 2014.</p> | <p>3/2015 Eurocopter (Deutschland)
EC135 T2+, G-SPAO
Glasgow City Centre, Scotland
on 29 November 2013.
Published October 2015.</p> |
| <p>2/2014 Eurocopter EC225 LP Super Puma
G-REDW, 34 nm east of Aberdeen,
Scotland on 10 May 2012
and
G-CHCN, 32 nm south-west of
Sumburgh, Shetland Islands
on 22 October 2012.
Published June 2014.</p> | <p>1/2016 AS332 L2 Super Puma, G-WNSB
on approach to Sumburgh Airport
on 23 August 2013.
Published March 2016.</p> |
| <p>3/2014 Agusta A109E, G-CRST
Near Vauxhall Bridge,
Central London
on 16 January 2013.
Published September 2014.</p> | <p>2/2016 Saab 2000, G-LGNO
approximately 7 nm east of
Sumburgh Airport, Shetland
on 15 December 2014.
Published September 2016.</p> |
| <p>1/2015 Airbus A319-131, G-EUOE
London Heathrow Airport
on 24 May 2013.
Published July 2015.</p> | <p>1/2017 Hawker Hunter T7, G-BXFI
near Shoreham Airport
on 22 August 2015.
Published March 2017.</p> |
| <p>2/2015 Boeing B787-8, ET-AOP
London Heathrow Airport
on 12 July 2013.
Published August 2015.</p> | <p>1/2018 Sikorsky S-92A, G-WNSR
West Franklin wellhead platform,
North Sea
on 28 December 2016.
Published March 2018.</p> |

Unabridged versions of all AAIB Formal Reports, published back to and including 1971,
are available in full on the AAIB Website

<http://www.aaib.gov.uk>

GLOSSARY OF ABBREVIATIONS

aal	above airfield level	lb	pound(s)
ACAS	Airborne Collision Avoidance System	LP	low pressure
ACARS	Automatic Communications And Reporting System	LAA	Light Aircraft Association
ADF	Automatic Direction Finding equipment	LDA	Landing Distance Available
AFIS(O)	Aerodrome Flight Information Service (Officer)	LPC	Licence Proficiency Check
agl	above ground level	m	metre(s)
AIC	Aeronautical Information Circular	MDA	Minimum Descent Altitude
amsl	above mean sea level	METAR	a timed aerodrome meteorological report
AOM	Aerodrome Operating Minima	min	minutes
APU	Auxiliary Power Unit	mm	millimetre(s)
ASI	airspeed indicator	mph	miles per hour
ATC(C)(O)	Air Traffic Control (Centre)(Officer)	MTWA	Maximum Total Weight Authorised
ATIS	Automatic Terminal Information Service	N	Newtons
ATPL	Airline Transport Pilot's Licence	N_R	Main rotor rotation speed (rotorcraft)
BMAA	British Microlight Aircraft Association	N_g	Gas generator rotation speed (rotorcraft)
BGA	British Gliding Association	N_1	engine fan or LP compressor speed
BBAC	British Balloon and Airship Club	NDB	Non-Directional radio Beacon
BHPA	British Hang Gliding & Paragliding Association	nm	nautical mile(s)
CAA	Civil Aviation Authority	NOTAM	Notice to Airmen
CAVOK	Ceiling And Visibility OK (for VFR flight)	OAT	Outside Air Temperature
CAS	calibrated airspeed	OPC	Operator Proficiency Check
cc	cubic centimetres	PAPI	Precision Approach Path Indicator
CG	Centre of Gravity	PF	Pilot Flying
cm	centimetre(s)	PIC	Pilot in Command
CPL	Commercial Pilot's Licence	PNF	Pilot Not Flying
°C,F,M,T	Celsius, Fahrenheit, magnetic, true	POH	Pilot's Operating Handbook
CVR	Cockpit Voice Recorder	PPL	Private Pilot's Licence
DME	Distance Measuring Equipment	psi	pounds per square inch
EAS	equivalent airspeed	QFE	altimeter pressure setting to indicate height above aerodrome
EASA	European Aviation Safety Agency	QNH	altimeter pressure setting to indicate elevation amsl
ECAM	Electronic Centralised Aircraft Monitoring	RA	Resolution Advisory
EGPWS	Enhanced GPWS	RFFS	Rescue and Fire Fighting Service
EGT	Exhaust Gas Temperature	rpm	revolutions per minute
EICAS	Engine Indication and Crew Alerting System	RTF	radiotelephony
EPR	Engine Pressure Ratio	RVR	Runway Visual Range
ETA	Estimated Time of Arrival	SAR	Search and Rescue
ETD	Estimated Time of Departure	SB	Service Bulletin
FAA	Federal Aviation Administration (USA)	SSR	Secondary Surveillance Radar
FDR	Flight Data Recorder	TA	Traffic Advisory
FIR	Flight Information Region	TAF	Terminal Aerodrome Forecast
FL	Flight Level	TAS	true airspeed
ft	feet	TAWS	Terrain Awareness and Warning System
ft/min	feet per minute	TCAS	Traffic Collision Avoidance System
g	acceleration due to Earth's gravity	TGT	Turbine Gas Temperature
GPS	Global Positioning System	TODA	Takeoff Distance Available
GPWS	Ground Proximity Warning System	UAS	Unmanned Aircraft System
hrs	hours (clock time as in 1200 hrs)	UHF	Ultra High Frequency
HP	high pressure	USG	US gallons
hPa	hectopascal (equivalent unit to mb)	UTC	Co-ordinated Universal Time (GMT)
IAS	indicated airspeed	V	Volt(s)
IFR	Instrument Flight Rules	V_1	Takeoff decision speed
ILS	Instrument Landing System	V_2	Takeoff safety speed
IMC	Instrument Meteorological Conditions	V_R	Rotation speed
IP	Intermediate Pressure	V_{REF}	Reference airspeed (approach)
IR	Instrument Rating	V_{NE}	Never Exceed airspeed
ISA	International Standard Atmosphere	VASI	Visual Approach Slope Indicator
kg	kilogram(s)	VFR	Visual Flight Rules
KCAS	knots calibrated airspeed	VHF	Very High Frequency
KIAS	knots indicated airspeed	VMC	Visual Meteorological Conditions
KTAS	knots true airspeed	VOR	VHF Omnidirectional radio Range
km	kilometre(s)		
kt	knot(s)		
