



Rail Accident Investigation Branch

Rail Accident Report



Overturning of a tram at Sandilands junction, Croydon 9 November 2016

Report 18/2017
v2.2 - October 2020

This investigation was carried out in accordance with:

- the Railway Safety Directive 2004/49/EC;
- the Railways and Transport Safety Act 2003; and
- the Railways (Accident Investigation and Reporting) Regulations 2005.

© Crown copyright 2018

You may re-use this document/publication (not including departmental or agency logos) free of charge in any format or medium. You must re-use it accurately and not in a misleading context. The material must be acknowledged as Crown copyright and you must give the title of the source publication. Where we have identified any third party copyright material you will need to obtain permission from the copyright holders concerned. This document/publication is also available at www.raib.gov.uk.

Any enquiries about this publication should be sent to:

RAIB	Email: enquiries@raib.gov.uk
The Wharf	Telephone: 01332 253300
Stores Road	Website: www.gov.uk/raib
Derby UK	
DE21 4BA	

This report is published by the Rail Accident Investigation Branch, Department for Transport.

Version	Date	Location	Description of change
v1	December 2017	Initial issue	
v2	October 2018	Paras S13 and 53	Typographic corrections
		Figures 23 and 45	Titles amended
		Table 16	Data in columns 1 and 2 reversed for bodyside windows
		Paras 335 to 338	BS EN reference number corrected
		Paras 362	Heading above clause amended
		Header before para 485	Reference to RAIB's July 2017 letter added (as footnote).
		Appendix I	New appendix containing RAIB's July 2017 letter
		Addendum (October 2018)	Added after appendices, refers to TfL audit of TOL's fatigue management system
		Index	Amended to suit changes listed above
v2.1	November 2019	Recommendation 10	Intent text augmented to match recommendation
v2.2	October 2020	Para 226	Correction of typographical error ('4 March 2013' altered to read '4 March 2014')
		Para 404	Correction of typographical error ('18 May 2017' altered to read '17 May 2017')

This page is intentionally left blank

Preface

The purpose of a Rail Accident Investigation Branch (RAIB) investigation is to improve railway safety by preventing future railway accidents or by mitigating their consequences. It is not the purpose of such an investigation to establish blame or liability. Accordingly, it is inappropriate that RAIB reports should be used to assign fault or blame, or determine liability, since neither the investigation nor the reporting process has been undertaken for that purpose.

The RAIB's findings are based on its own evaluation of the evidence that was available at the time of the investigation and are intended to explain what happened, and why, in a fair and unbiased manner.

Where the RAIB has described a factor as being linked to cause and the term is unqualified, this means that the RAIB has satisfied itself that the evidence supports both the presence of the factor and its direct relevance to the causation of the accident. However, where the RAIB is less confident about the existence of a factor, or its role in the causation of the accident, the RAIB will qualify its findings by use of the words 'probable' or 'possible', as appropriate. Where there is more than one potential explanation the RAIB may describe one factor as being 'more' or 'less' likely than the other.

In some cases factors are described as 'underlying'. Such factors are also relevant to the causation of the accident but are associated with the underlying management arrangements or organisational issues (such as working culture). Where necessary, the words 'probable' or 'possible' can also be used to qualify 'underlying factor'.

Use of the word 'probable' means that, although it is considered highly likely that the factor applied, some small element of uncertainty remains. Use of the word 'possible' means that, although there is some evidence that supports this factor, there remains a more significant degree of uncertainty.

An 'observation' is a safety issue discovered as part of the investigation that is not considered to be causal or underlying to the event being investigated, but does deserve scrutiny because of a perceived potential for safety learning.

The above terms are intended to assist readers' interpretation of the report, and to provide suitable explanations where uncertainty remains. The report should therefore be interpreted as the view of the RAIB, expressed with the sole purpose of improving railway safety.

The RAIB's investigation (including its scope, methods, conclusions and recommendations) is independent of any inquest or fatal accident inquiry, and all other investigations, including those carried out by the safety authority, police or railway industry.

This page is intentionally left blank

Overturning of a tram at Sandilands junction, Croydon, 9 November 2016

Contents

Preface	5
Summary	9
Introduction	18
Key definitions	18
The accident	19
Summary of the accident	19
Context	21
The sequence of events	35
Key facts and analysis	41
Background	41
Identification of the immediate cause	48
Identification of causal factors	56
Identification of underlying factors	74
Factors affecting the consequences	93
Observations	118
The role of the safety regulator	133
Previous occurrences relevant to this investigation	137
Occurrences on Croydon tramway	137
Occurrences outside Croydon tramway	138
Summary of conclusions	139
Immediate cause	139
Causal factors	139
Underlying factors	140
Factor affecting the severity of consequences	140
Observations and other issues	141
The role of the safety regulator	141
Previous RAIB recommendation relevant to this investigation	142
Recommendation that is currently being implemented	142
Actions reported as already taken or in progress relevant to this report	143

Background to the RAIB's recommendations	145
Recommendations	146
Safety Advice	155
Appendices	156
Appendix A - Glossary of abbreviations and acronyms	156
Appendix B - Glossary of terms	158
Appendix C - Investigation details	163
Appendix D - Loop data	164
Appendix E - Testing and examination of tram 2551 equipment	165
Appendix F - Urgent Safety Advice	169
Appendix G - Post-derailment sequence	170
Appendix H - On-tram data recorder	175
Appendix I - RAIB July 2017 letter to the UK tram industry	177
Addendum (October 2018)	179

Summary

The accident on 9 November 2016

- S1 For the people of New Addington and the surrounding areas, the tramway which links them to the centre of Croydon has become part of the landscape of their lives since its opening in 2000. It has an important role, taking residents to and from their work, shopping and leisure activities.
- S2 Early in the morning of 9 November 2016, 26 commuters boarded the tram which was to be the fifth service of the day, due to leave New Addington at 05:53 hrs. It was a dark morning, and heavy rain was falling. The tram, number 2551, left the terminus on time. Its journey took it past the Addington Village interchange, and through open country and woodland towards Croydon. It called at five stops along the route, picking up another 36 passengers and travelling at up to 80 km/h (50 mph). It then called at Lloyd Park, where seven more people boarded, so that as the tram moved into the built-up area on the eastern outskirts of Croydon, it was carrying 69 passengers.
- S3 Beyond Lloyd Park, the tramway curves sharply to the right and joins the route of a former railway line. The tram rounded this bend at about 20 km/h (12 mph), and then accelerated, on a long straight stretch of line. There are three closely spaced tunnels on this section, which together are just over 500 metres long. Less than 100 metres beyond the far end of the tunnels, the tramway leaves the alignment of the old railway on a sharp left-hand curve and then meets the other branch of the network, the route from Elmers End and Beckenham, at Sandilands junction.
- S4 The tram passed through the tunnels at around 80 km/h (50 mph). When it emerged from the far end (figure S1), at 06:07 hrs, it had not slowed down as trams normally do, and was still travelling at 78 km/h (48 mph). Through the darkness and heavy rain, the tram approached the reflective sign which marked the point where its speed should have been reduced to 20 km/h (12 mph) to negotiate the curve. The driver applied the brakes, but the tram was still travelling at 73 km/h (45 mph) when it passed the sign, entered the curve, and began to turn over onto its right-hand side.
- S5 The passengers on the tram had no warning of what was to come. Some of them were standing, but most were seated, and as the tram began to tilt they were thrown across and around the vehicle. Some described it as “like being in a washing machine”. The windows on the right-hand side smashed as passengers were thrown against them, and as the tram hit the ground. Some of the doors on that side were torn off. People fell through the openings where the doors and windows had been, and were crushed under the tram as it slid to a stop, about three seconds after leaving the rails. The tram came to rest after travelling a distance of about 27 metres from the place where it left the rails (figure S2).



Figure S1: View emerging from the tunnels

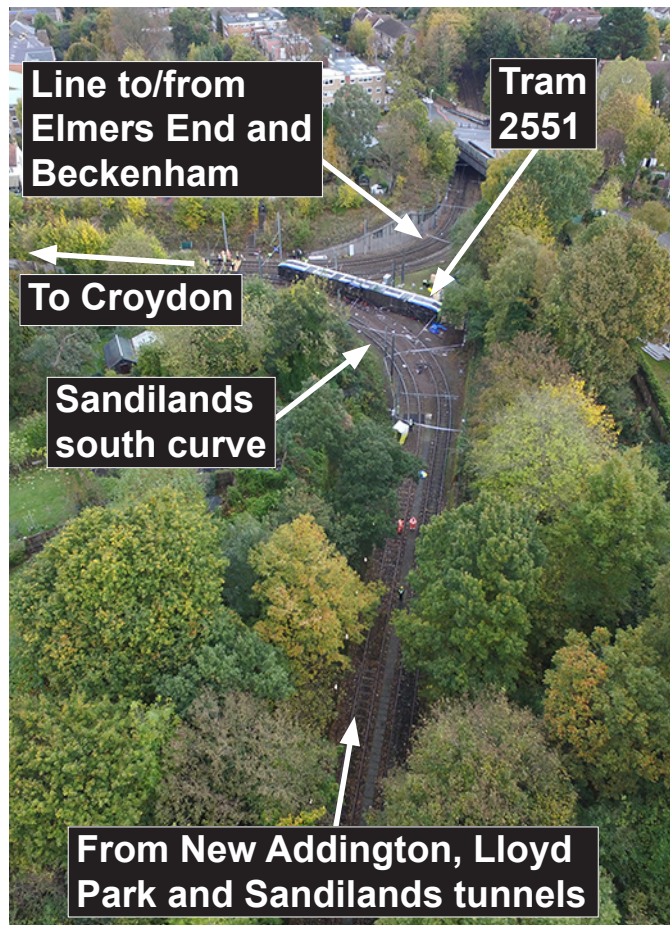

Figure S2: Final position of the tram

- S6 Seven people were killed, nineteen were seriously injured, and 43 had minor physical injuries (including the tram driver). Only one person was physically unhurt. A substantial number of people involved with the accident suffered shock and/or emotional trauma.
- S7 Those who lost their lives were:
- Dane Chinnery**
 - Donald Collett**
 - Robert Huxley**
 - Philip Logan**
 - Dorota Rynkiewicz**
 - Philip Seary**
 - Mark Smith**
- S8 The driver of the tram, who was slightly hurt, contacted the tramway control room by phone, and asked for the emergency services. Many of the passengers also used their phones to make 999 calls. The first person on the scene was the driver of a tram travelling out of Croydon, which had just left the Sandilands stop, when the accident caused it to lose power and stop. This driver walked forward to see what had happened, and he and the driver of tram 2551 used a fire extinguisher and a metal bar to make a hole in the front windscreen of the overturned tram, large enough for people to start to escape. The first police response officers arrived on the scene about five minutes after the accident, and four minutes after that firefighters, paramedics and ambulance crews began to assist the injured.

Tramways in the UK

- S9 This catastrophic accident was the worst to occur on a British tramway for more than 90 years. Towards the end of the nineteenth century, most large towns and cities in the UK acquired tramway networks. From the 1930s onwards, tram services, by then electrified, were replaced by buses, and the last major urban network, in Glasgow, closed in 1962. This left the system connecting Blackpool and Fleetwood as the only 'first generation' tramway remaining in operation, notable for its heritage features. From 1992, tramways again became part of the country's public transport systems, with the opening of the first part of the Manchester Metrolink network. Since then, the Blackpool tramway has been updated and a further five 'second generation' tramway systems have been built, one of which is the Croydon tramway, opened in 2000, and running from termini at Elmers End, Beckenham Junction and New Addington, through the centre of Croydon and on to Wimbledon.
- S10 Tramways are different from railways in several ways. The most significant, in the context of this accident, is that trams are driven on 'line-of-sight', with drivers expected to drive at a speed which will enable them to stop the tram in the distance that they can see ahead, like the drivers of road vehicles. This is in contrast to railways, where the movements of trains are regulated by lineside or in-cab signals, which give the driver permission to proceed as far as the next signal, and may also indicate how fast the train can travel.

- S11 Tram networks, like roads and railways, have speed limits which reflect the type of route, or the presence of curves, junctions and other physical features of the route. On tramways, these speed limits are shown on lineside signs, which mark the point at which the change in permitted speed begins.
- S12 Trains are driven on the basis that the track is unobstructed, even beyond the point the driver can see ahead, and railways have engineered systems that enforce compliance with signals and obedience to speed limits. Tramways do not have such systems, and until now, they have relied on the driver to control the tram's speed as necessary. Signals are provided only to control movements at junctions.

The investigation

- S13 The accident on 9 November immediately brought into question the way in which the speed of trams is controlled, and raised many other issues linked to the design, operation and management of trams and the routes they travel on. It was important that the RAIB's investigation should cover all of these areas, and make recommendations that will result in changes that minimise the chances of such a tragedy happening again.
- S14 The investigation itself began immediately, with a team of RAIB inspectors arriving at Sandilands just after 10:00 hrs on the morning of the accident. They examined the overturned tram, and the infrastructure along its route, in detail. Over the following months, the RAIB worked with the emergency services to record and reconstruct the positions of all the passengers on the tram, before and after the accident. With assistance from the British Transport Police, the RAIB has contacted all the surviving passengers from tram 2551.
- S15 The tram was recovered and moved to a secure location within the RAIB's premises near Aldershot, where a covered enclosure has enabled further detailed examination and testing to take place. Some components of the tram have been tested by specialist consultants in dedicated facilities elsewhere.
- S16 During the investigation the RAIB kept in close touch with operators of all the tramways in the UK. Based on our early findings, we issued urgent safety advice to the operators of the Croydon tramway in November 2016, advising them to take action to reduce the risk of trams approaching the curve at excessive speed. In response to this, the infrastructure manager installed additional signs on the route before resuming services after the accident, and also installed similar signs at three other locations on the tramway (report paragraph 479). Other tram operators took similar action (report paragraph 480).
- S17 The RAIB has interviewed many witnesses, both in relation to the accident itself, and in connection with all the circumstances leading up to it. Among many ways in which we gathered information on how the tramway has been run, we circulated a questionnaire to all 146 drivers on the Croydon tramway.

This report

Background

S18 The report describes the areas of investigation, beginning with the events of 9 November (report paragraphs 45 to 65). It goes on to describe the background to the accident, including the regulatory regime that was being operated during the authorisation, design, construction and commissioning of the Croydon tramway (report paragraphs 66 to 71). It also examines the way in which the Croydon tramway applies the principles of line-of-sight driving to the training, assessment and management of drivers (report paragraphs 72 to 90).

The causes of the accident

S19 The immediate cause of the accident was that the tram overturned because it was travelling too fast to negotiate the curve. Detailed analysis of damage, computer simulation and calculations have enabled the RAIB to establish the dynamics of the event. This has confirmed that the tram would have overturned if it had entered the curve at any speed greater than 49 km/h (30 mph); its actual speed was 73 km/h (45 mph) as it entered the curve (report paragraphs 95 to 118).

S20 The tram did not slow down sufficiently before entering the curve because the driver did not apply sufficient braking. There was no evidence of any fault with the tram that could have caused or contributed to the inadequate braking (report paragraphs 119 to 122).

The driving of the tram

S21 The report considers the driver's actions, and the reasons for them. Although it can never be completely ruled out, the RAIB found no evidence that the driver's health or medical fitness contributed to what happened. He had been driving trams in Croydon since 2008, had a good safety record and had driven round the curve at Sandilands many times: records show that he had driven round it at least 693 times since the beginning of 2015. There is no evidence that he was distracted by anything inside or outside the tram, or by using a mobile phone or radio (report paragraphs 123 to 135).

S22 After the tram rounded the curve at Lloyd Park, the driver applied power and let the tram reach its maximum speed. He then needed to do very little to control the tram's speed for about 49 seconds, as the tram ran through the tunnel. This is the longest section on the whole of the tramway on which there is minimal requirement for any active control by the driver. Compared with other sections of the tramway, this presents a relatively low level of workload to the driver. It is also the case that the tunnels did not contain distinctive features which would alert drivers during darkness to their normal braking point.

S23 Although some doubt remains as to the reasons for the driver not applying sufficient braking, the RAIB has concluded that the most likely cause was a temporary loss of awareness of the driving task during a period of low workload, which possibly caused him to microsleep. It is also possible that, when regaining awareness, the driver became confused about his location and direction of travel (report paragraphs 119 to 179).

S24 The investigation considered whether the driver may have been fatigued. It concluded that the shift pattern followed by the driver should not have caused an increased risk of fatigue on the morning of the accident, above the general fatigue risk factor of very early starts, but that it is possible his sleep pattern could have led to a sleep debt, a situation which can result in microsleeps (report paragraphs 143 to 152).

Previous incidents

S25 On 31 October 2016, less than two weeks before the accident, there had been an incident in which a tram went too fast round the curve at Sandilands. On that occasion a different tram driver mistook his position in the tunnel, braked late, and entered the curve at more than 45 km/h (28 mph), a speed at which it is likely that the tram was close to tipping over. For various reasons, this incident was not fully investigated by Tram Operations Ltd (TOL), which is the operator of the trams, until after the accident on 9 November (report paragraphs 180 to 191).

S26 Some tram drivers on the Croydon system reported to the RAIB that there have been occasions on which they had used heavy braking or used the hazard (emergency) brake in order to control their speed at this location. None of them reported these events to the managers at TOL, mainly because of the perceived attitude of some managers and because the drivers feared the consequences for themselves if they did so. This meant that TOL management did not understand the extent of late braking, and so took no action to mitigate the risk (report paragraphs 224 to 231).

The management of risk

S27 An important underlying factor in the accident was that TOL and London Trams (LT), a part of Transport for London which maintains the tramway infrastructure and the trams, had not recognised the actual level of risk associated with overspeeding on a curve, and therefore had not identified the need for additional control measures. TOL had carried out an assessment of the hazards on the route, but had not identified overturning on this curve, or on any other curves, as a consequence of excessive speed. There had been no accident in the UK involving a tram overturning since 1953, and although only a few had occurred in the rest of the world (report paragraph 216), a tram overturning was nevertheless a real possibility.

S28 The investigation found that the risk of trams overturning due to excessive speed around curves, had not been addressed by UK tramway designers, owners, operators or the safety regulator (report paragraphs 249 to 276). In the other UK tram systems, the speed limit signs provided are generally similar to those in Croydon. Additional signs were added after the RAIB issued urgent safety advice to the tramway industry during the investigation. The way in which UK tramways set out signs for speed restrictions approaching curves provides less warning to tram drivers than is given to UK road users on comparable modern roads, and to drivers on many tramways in the rest of Europe.

The consequences of the accident

- S29 Detailed analysis of the injuries people suffered showed that the principal cause of death and serious injury in this accident was the ejection of passengers through the windows and doors on the right-hand side of the tram. Tests carried out during the investigation showed that the windows could have been shattered by passengers being thrown against them, and would in any case have shattered on impact with the ground. Although they met regulatory requirements, the windows were made of toughened glass, which provides little resistance to the ejection of passengers. Similarly, although complying with relevant design standards, it is also likely that the way the doors were attached to the tram meant that some of the doors were not able to contain passengers when they fell against them during the accident (report paragraphs 277 to 344).
- S30 There were no emergency exits available from the overturned tram. It was necessary for the tramway staff and the emergency services to break the front and rear windscreens to make routes by which all the passengers who were able to, could eventually be evacuated (report paragraphs 350 to 361). The emergency lighting was disabled when the tram overturned, meaning that immediately after the accident the survivors were plunged into darkness (report paragraphs 345 to 349).

Other observations

- S31 During the investigation, the RAIB observed that, although not a factor in the accident at Sandilands junction, TOL's management of the risk of tram driver fatigue was not always in line with published industry practice. Areas of concern include rostering and rest day working, not fostering a culture which encouraged drivers to report fatigue, and not providing guidance for drivers on managing their own fatigue (report paragraphs 362 to 382).
- S32 Although there is evidence of some tram drivers sometimes exceeding the speed limit, generally by small amounts, there is no evidence of a culture of speeding contributing to the accident (report paragraphs 383 to 400).
- S33 Other observations included:
- in common with most trams and trains in the world, there was no device fitted to the Croydon trams that was capable of reliably detecting drivers' loss of awareness (report paragraphs 401 to 407);
 - the CCTV system fitted to tram 2551 was not working (report paragraphs 408 to 421); and
 - some of the vehicle maintenance instructions were not up to date (report paragraphs 422 to 425).
- S34 UK tramways do not have a mechanism to promote effective sharing of safety information or the development of common approaches to the management of risk. This meant that data on safety performance is not routinely shared between operators, and there is little evidence of the use of common risk assessment techniques (report paragraphs 426 to 433).

The role of the regulator

S35 ORR's regulatory strategy provided a lower level of intervention for tramways than for other sectors, consistent with its evaluation of the risk and the regulatory framework in place for tramways. However, the RAIB's analysis of the evidence suggests that the overall level of risk on tramways, and the potential for multiple fatality accidents, is higher than previously assumed. For this reason, and given the scope for safety improvements in the sector, there is a need to review the regulatory strategy (report paragraphs 434 to 451).

Recommendations

- S36 The RAIB has made 15 recommendations (report paragraph 491) as a result of this investigation. Several of these are addressed to all the operators in the UK tram industry. Some of them need to be implemented by co-operation between the individual operators, and for this reason we are recommending the establishment of a permanent body to facilitate a long term cooperative approach to UK tramway safety, which will require both suitable funding and access to data from all UK tramways.
- S37 To prevent an accident like this happening again, we believe it is important that an automatic system should be developed and installed that will slow a tram if it approaches a higher risk location, such as a sharp curve, at a speed which could lead to it derailing or overturning. Such systems are already in use on main line railways. We also recommend consideration and, if appropriate, installation of systems which automatically intervene if a driver displays a low level of alertness. Our other recommendations focus on the need for better understanding of the risk associated with tramways, and updated guidance on how tramways should be designed, operated and maintained.
- S38 The lineside signs provided to warn tram drivers of speed restrictions, and other information about high risk locations, should be improved taking account of the requirements for other road users (such as bus drivers). Recommendations relating to the design of vehicles are intended to reduce the likelihood of passengers being ejected during a collision or derailment, and to provide adequate lighting and exit routes in an emergency. There are specific recommendations about ORR's regulatory activities, and TOL's processes for the management of operational risk, tram driver fatigue, and some aspects of safety culture. For TOL and LT jointly, we identify the need to improve the way they use information from the public, manage and maintain CCTV equipment, and document tram maintenance procedures.
- S39 The RAIB has no powers to make recommendations in areas outside railway and tramway safety, but the report also includes safety advice to the Department for Transport and the bus industry, in relation to the strength and containment capability of windows and doors on buses and coaches (report paragraph 492).
- S40 If there is one overriding lesson to learn from this tragic accident, it is that safe operation of a tram network depends on thinking about possible accident scenarios outside the immediate experience of the managers and their teams. The UK tramway community did not appreciate that such a catastrophic accident could occur.

Acknowledgments

S41 The RAIB would particularly like to thank the families of those who died and the surviving passengers for the information which they gave to us in very difficult circumstances. We would also like to thank all the organisations who assisted with this investigation, and the Croydon tram drivers who completed our questionnaire.

Introduction

Key definitions

- 1 Metric units are used in this report. Where the RAIB considers it may help understanding, the equivalent imperial value is also given.
- 2 The report contains abbreviations and technical terms (shown in *italics* the first time they appear in the report). These are explained in Appendices A and B. Sources of evidence used in the investigation and organisations which assisted the RAIB investigation are listed in Appendix C.
- 3 References to '*inbound*' relate to trams travelling towards Croydon town centre and '*outbound*' relate to trams travelling away from Croydon town centre. Left and right-hand sides are relative to the direction of travel of the tram. The curve on which the accident occurred is designated in this report as the inbound line of Sandilands south curve.

The accident

Summary of the accident

- 4 At about 06:07 hrs on Wednesday 9 November 2016, a tram running between New Addington and Wimbledon overturned on a curve as it approached Sandilands junction, in Croydon (figures 1 and 2).

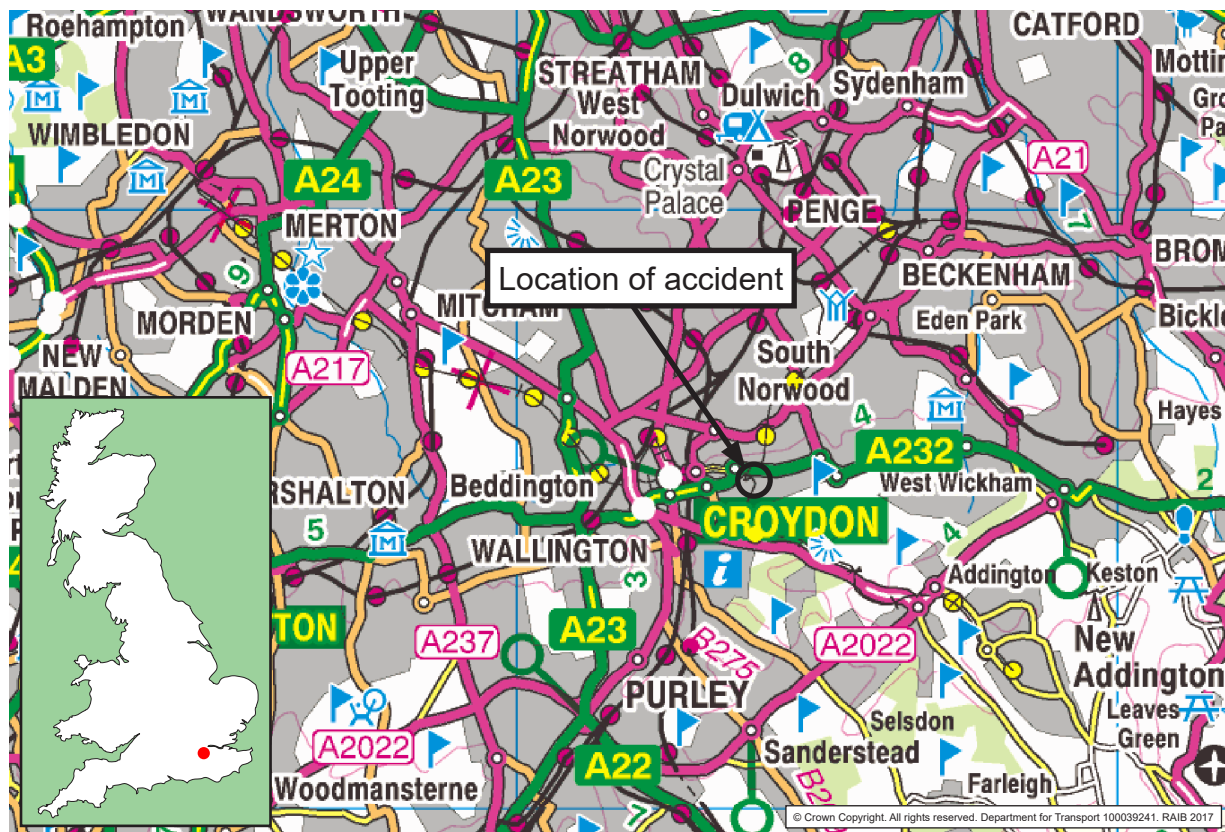

Figure 1: Extract from Ordnance Survey map showing location of accident (overview)

- 5 The tram (figure 3) was travelling at 78 km/h (48 mph) as it left a tunnel and approached the curve leading into Sandilands junction. About 2.5 seconds before reaching a speed sign located at the start of the curve and denoting the start of a 20 km/h (12 mph) speed restriction, the tram's *service brake* was applied. The tram had slowed to approximately 73 km/h (45 mph) as it entered the curve and then travelled around part of this before overturning, sliding a short distance on its side and then stopping close to the junction (figure 4). The tram's hazard (emergency) brake was not used.
- 6 Of the 70 people on the tram (including the tram driver), seven people lost their lives, 19 people suffered serious injuries¹ and 43 people received minor injuries.

¹ This report uses the definition of serious injury given in the Railways (Accident Investigation and Reporting) Regulations 2005.

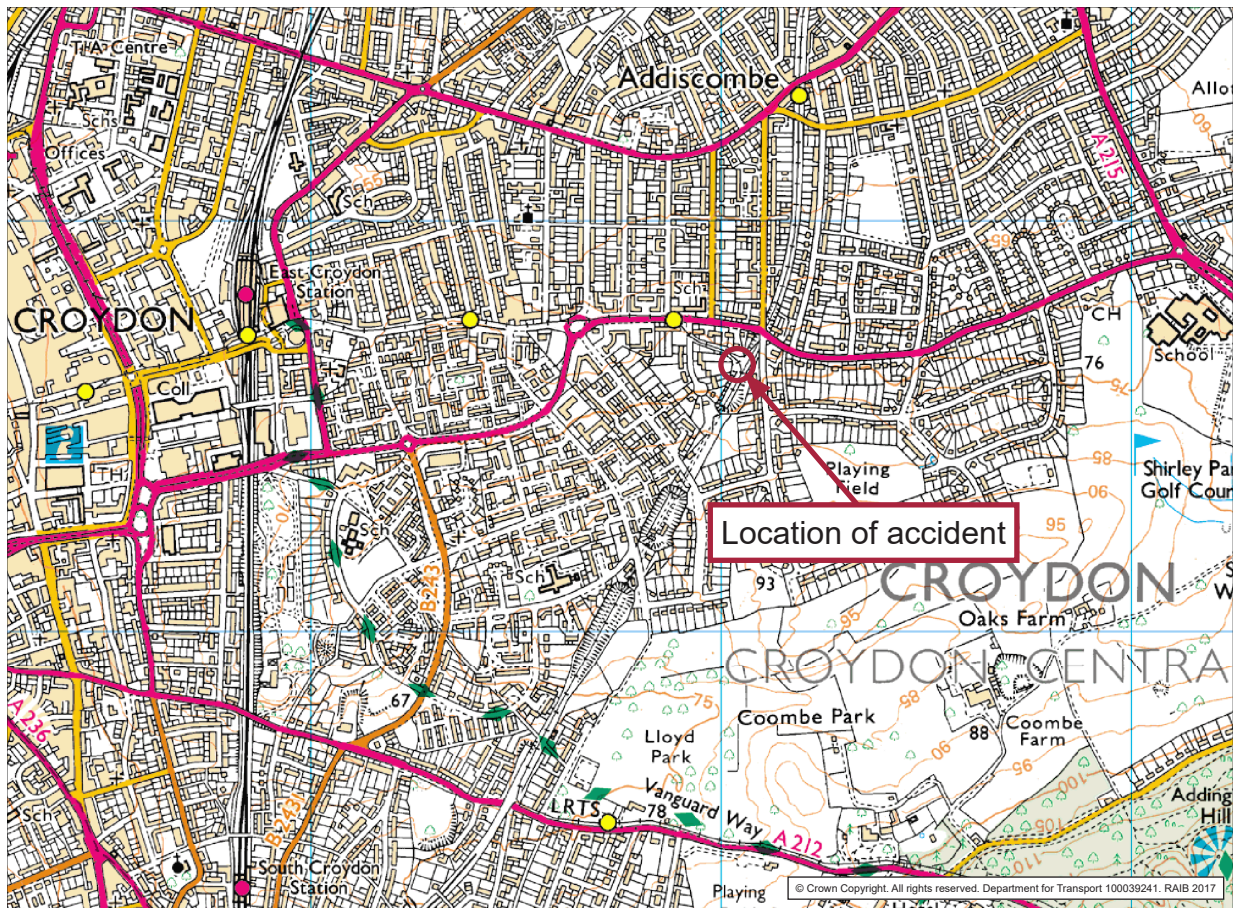

Figure 2: Extract from Ordnance Survey map showing location of accident (local view)



Figure 3: A typical CR4000 tram (not the one involved in the accident)



Figure 4: Final position of the tram

Context

Location

- 7 The Croydon tram network in south London comprises lines from Croydon town centre to New Addington, Elmers End, Beckenham Junction and Wimbledon. The accident occurred on a curve approaching Sandilands junction, about 1.8 km (1.1 miles) east of Croydon town centre (figure 2).
- 8 The line from New Addington serves five other tram stops before reaching Lloyd Park and continuing through Sandilands junction to Sandilands tram stop (figure 5). The branch from Beckenham Junction tram stop serves four other stops before being joined by the branch from Elmers End near Arena tram stop. The line then continues through two more tram stops before reaching Addiscombe and then Sandilands junction, where it joins the line from New Addington before continuing to Sandilands tram stop and onwards towards Croydon town centre and Wimbledon.

Organisations involved

- 9 The Croydon tramway was constructed in the late 1990s and public services started in May 2000. It was developed, constructed and financed by a private consortium, Tramtrack Croydon Limited (TCL), which included Bombardier Transportation and CentreWest Ltd, following the award of a 99-year concession from London Regional Transport. The concession contract commenced in November 1996. It provided that, once constructed, TCL would maintain and operate the tramway. TCL subcontracted tram operation to Tram Operations Ltd (TOL), a wholly owned subsidiary of CentreWest Ltd, which became part of FirstGroup in 1997.

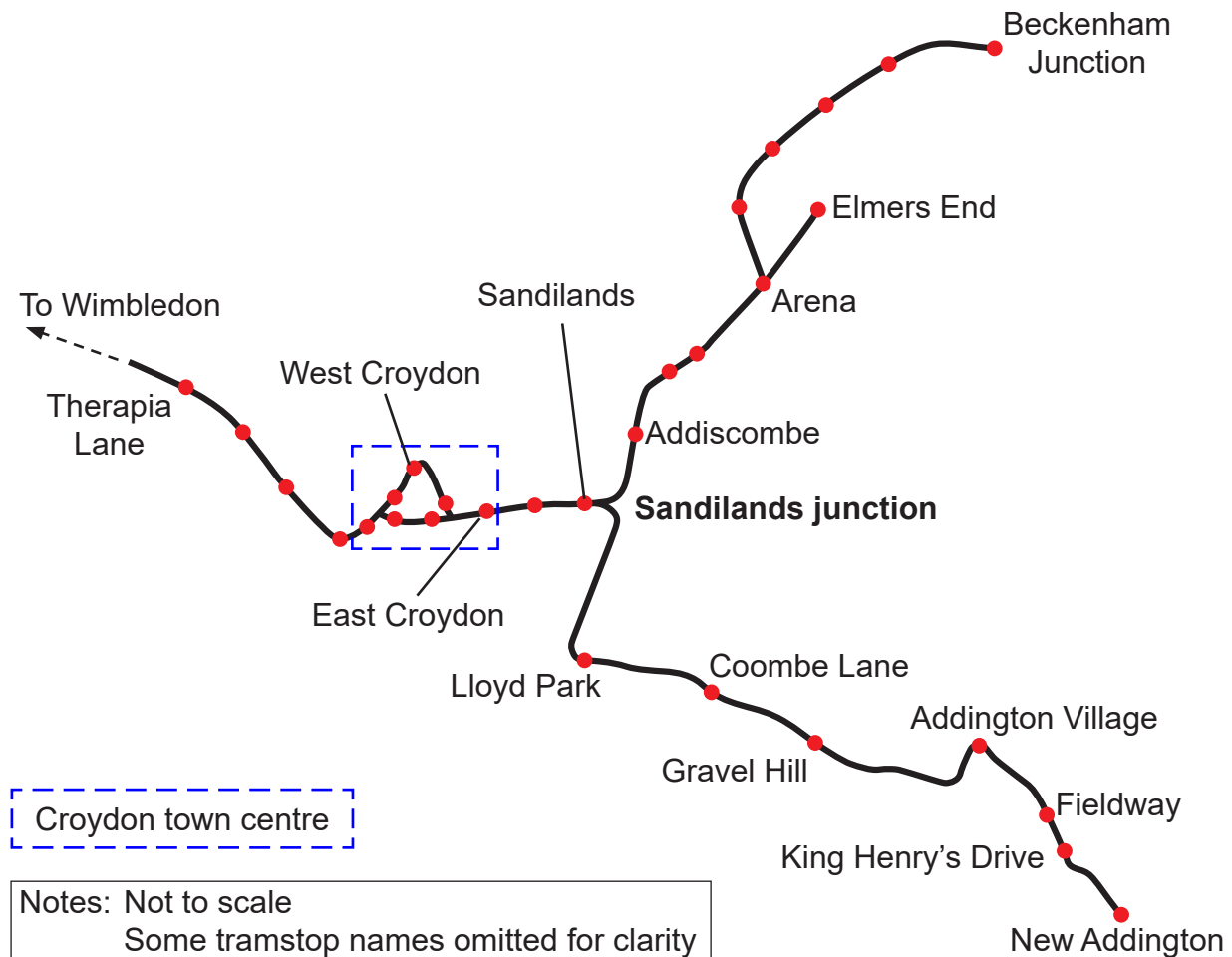

Figure 5: Croydon tram network

- 10 TCL was purchased by Transport for London (TfL) in a process that was finalised on 28 June 2008. TCL then continued to manage the tram infrastructure and subsequently took over maintenance of the trams. Although the legal name remained unaltered, TCL is now usually described as London Trams (LT) and this designation is used throughout this report. LT employed the staff responsible for maintaining the trams and the infrastructure.
- 11 TOL continued operating the trams as a subsidiary of FirstGroup after TCL was purchased by TfL. TOL is managed as part of FirstGroup's rail division, sitting alongside *main line* rail operations. It is responsible for operating the trams to the prescribed timetable and employs operational staff including tram drivers, *line controllers* and managers.
- 12 TfL manages LT as part of TfL's Surface Transport organisation, whose other responsibilities include London Overground, Docklands Light Railway and London buses.
- 13 Bombardier Transportation supplied 24 CR4000 trams, which have been used since the tramway opened in May 2000 and included tram 2551 (the accident tram). Additional trams, of a different design, were provided by another manufacturer in 2015/16. Bombardier undertook the maintenance of the CR4000 trams at Therapia Lane depot until late 2014 when this role was transferred to LT.

- 14 Her Majesty's Railway Inspectorate (HMRI), then part of the Health and Safety Executive (HSE), carried out the assessments, inspections and approvals required before the tramway could be opened for public use. It also produced guidance applicable to tramways which was first published in 1997 (paragraph 69).
- 15 The Office of Rail Regulation, which became the Office of Rail and Road in 2015 (both known as ORR), has regulated safety on the British rail and tram networks since HMRI was transferred to ORR in 2006. ORR updated the guidance applicable to tramways in 2006.
- 16 UKTram is the trade body representing owners and operators of tramways in the UK. Management of the tramway guidance published by ORR in 2006 was transferred to UKTram in 2015 (paragraph 69).

Infrastructure

- 17 The tramway control room operated by TOL, and the tram maintenance facility operated by LT, are both located at the Therapia Lane tram depot about 2.7 km (1.7 miles) northwest of Croydon town centre. The control room is operated by TOL line controllers. The controller overseeing control room activities is designated the *duty manager*.
- 18 Signals are provided to prevent collisions where tram tracks join, to indicate the route set at locations where tram tracks diverge and, at some road junctions, to prevent collisions with road vehicles. The signals and *points* are usually controlled automatically based on wireless data signals passed between trams and aerials comprising loops of wire laid between the rails of a track. Data collected by this control system records the tram number, the driver's identification number and timing information which, although not intended for this purpose, has allowed the RAIB to calculate approximate tram speeds. This is explained further in paragraph 386 and Appendix D.
- 19 The accident occurred on Sandilands south curve, the inbound approach to Sandilands junction from the New Addington direction. The section of track from the previous tram stop (Lloyd Park) to Sandilands junction is not part of a public highway or road, a configuration known as off-street running (paragraph 70). This line joins the public highway, and *on-street* running starts (paragraph 70), shortly after Sandilands tram stop (figure 6).
- 20 Trams travelling towards Sandilands from Lloyd Park (ie in the inbound direction towards Croydon town centre) pass over a public road crossing, Lloyd Park Avenue, immediately before a 20 km/h (12 mph) speed restriction around a tight right-hand curve about 170 metres beyond Lloyd Park tram stop, where the line meets a former railway alignment. The speed then increases to the maximum permitted on the tramway, 80 km/h (50 mph) at the time of the accident, with the line passing over Larcombe Close public road crossing, and then running straight and in the open for about 525 metres before reaching the first of three closely-spaced tunnels.

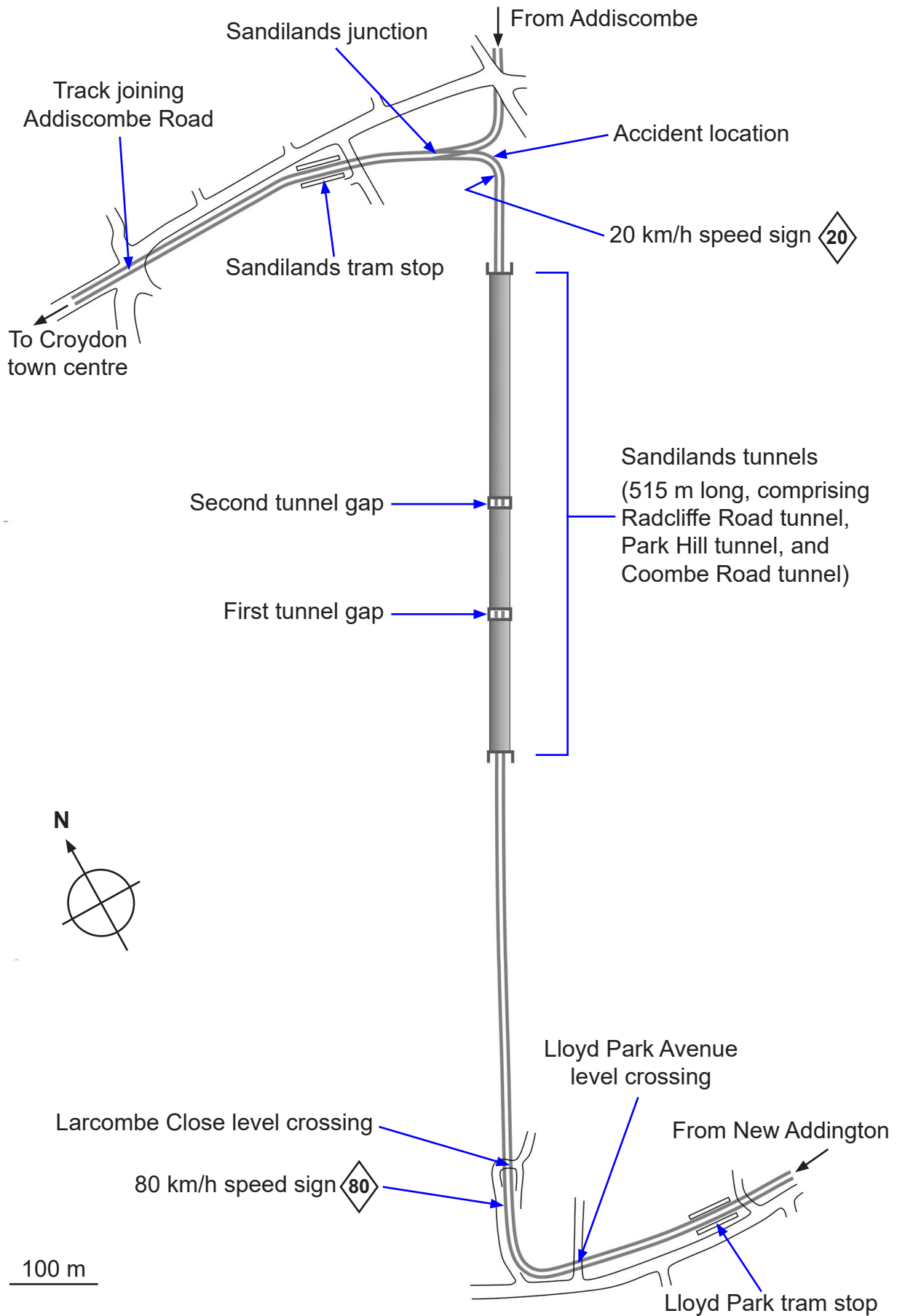

Figure 6: Lloyd Park to Sandilands tramway layout (changes since the accident are not shown here and, where appropriate, not shown on other figures)

- 21 The line falls gently towards Sandilands as it continues on a broadly straight alignment through the tunnels. These are the only tunnels on the Croydon tramway and are known collectively as the Sandilands tunnels. When travelling from Lloyd Park, they comprise:
- Coombe Road tunnel, 144 metres long;
 - a gap of around 6 metres, described as the *first tunnel gap* in this report;
 - Park Hill tunnel, 112 metres long;
 - a gap of around 6 metres described as the *second tunnel gap* in this report; and finally
 - Radcliffe Road tunnel, 243 metres long.
- 22 When the Croydon tramway opened, the three tunnels were lit throughout with lights around 1.6 metres long and positioned around 3.4 metres above the ground (figure 7). There were lights on both sides of the tunnel, spaced at approximately 25 metre intervals through the main portion of the tunnel. Closely spaced (almost continuous) lights were provided for a distance of about 58 metres inside both ends of the tunnel group. A post-accident inspection by the RAIB showed that many of the lights were not lit (paragraph 167). The tunnel lights were switched on day and night to illuminate a walkway between the tracks that is provided to enable passengers to evacuate from a tram in an emergency.
- 23 On exiting from the Sandilands tunnels, trams travelling towards Sandilands junction emerge into a cutting and continue in a broadly straight line for a distance of about 94 metres until they reach the start of the left-hand curve on which the accident occurred (figures 8 and 9).



Figure 7: View towards Sandilands south curve from within the third tunnel

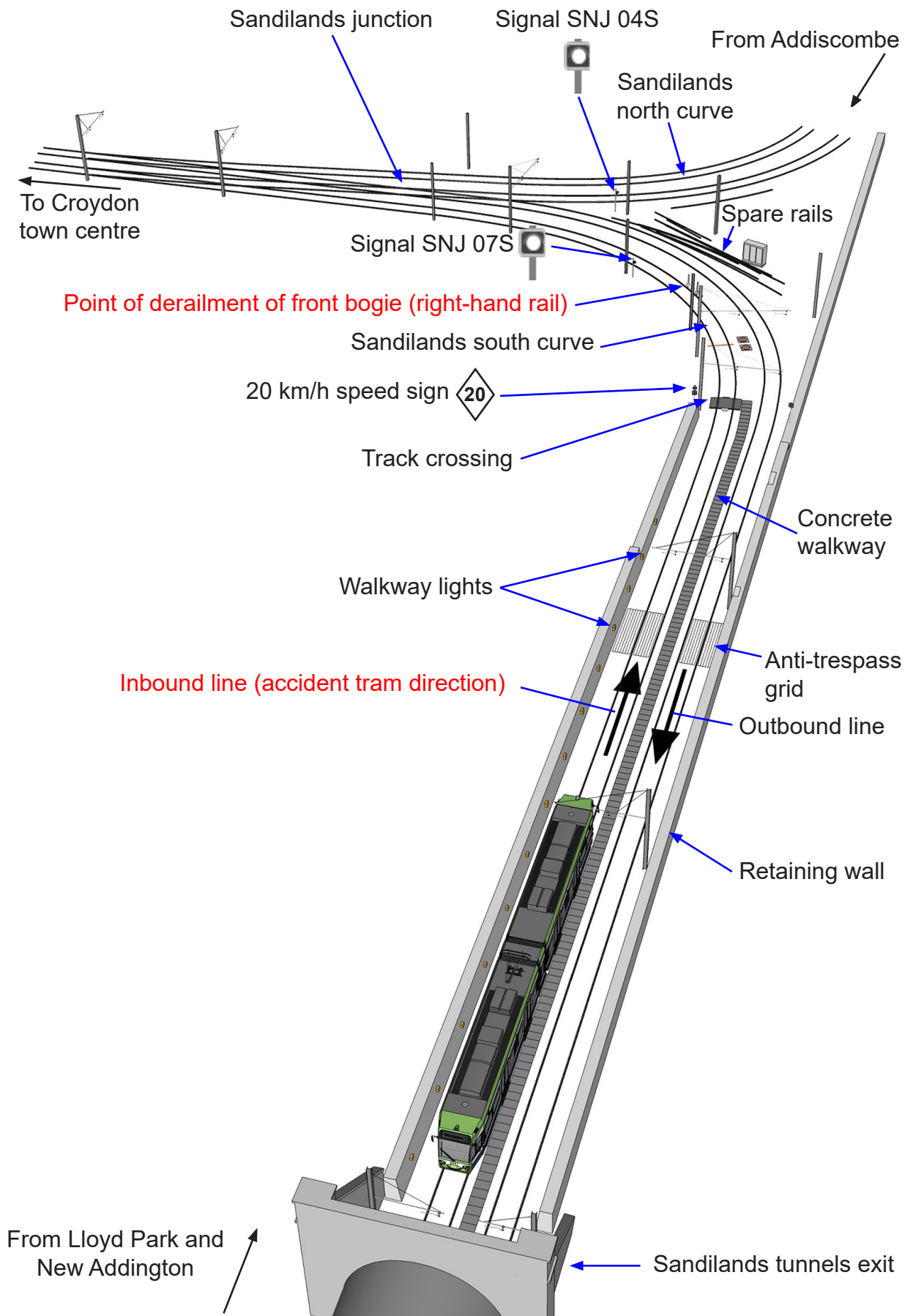

Figure 8: Accident site



Figure 9: Approach to Sandilands south curve viewed from tunnel exit (overturned tram visible in distance)

- 24 Along this section of straight track, and starting seven metres beyond the tunnel exit, there is a row of walkway lights fitted to the cutting wall adjacent to the left side of the track. These are positioned approximately five metres apart for a distance of around 70 metres, and are between 0.8 and 1.3 metres above ground level. These lights were installed in 2013 to illuminate a walkway used by tram drivers when they needed to park trams at that location during engineering works (figure 9).
- 25 A reflective diamond shaped sign is located close to the start of the inbound Sandilands south curve (figure 10). This sign denoted the start of the 20 km/h (12 mph) speed restriction, which is required because the inbound curve has a radius of 30 metres (figure 11). The speed restriction sign was 607 mm high by 405 mm wide and was mounted directly above an 'SI' sign indicating a *section insulator*, part of the electrical system used to supply power to the trams (paragraph 27). The concrete walkway running between the inbound and outbound lines in the tunnel continues through the cutting until it reaches a track crossing close to the speed sign.
- 26 A signal is located to the left of the inbound curve around 30 metres beyond the 20 km/h speed sign (figure 11). This signal, number SNJ 07S, is provided to prevent a conflicting move between a tram approaching Sandilands tram stop from Lloyd Park and another approaching from Addiscombe. The signal normally shows a stop indication until a tram approaching from the Lloyd Park direction is around 57 metres from it, when it normally changes to a proceed indication if there is no conflicting tram movement on the line from Addiscombe. The corresponding signal controlling tram movements from the Addiscombe direction is SNJ 04S.

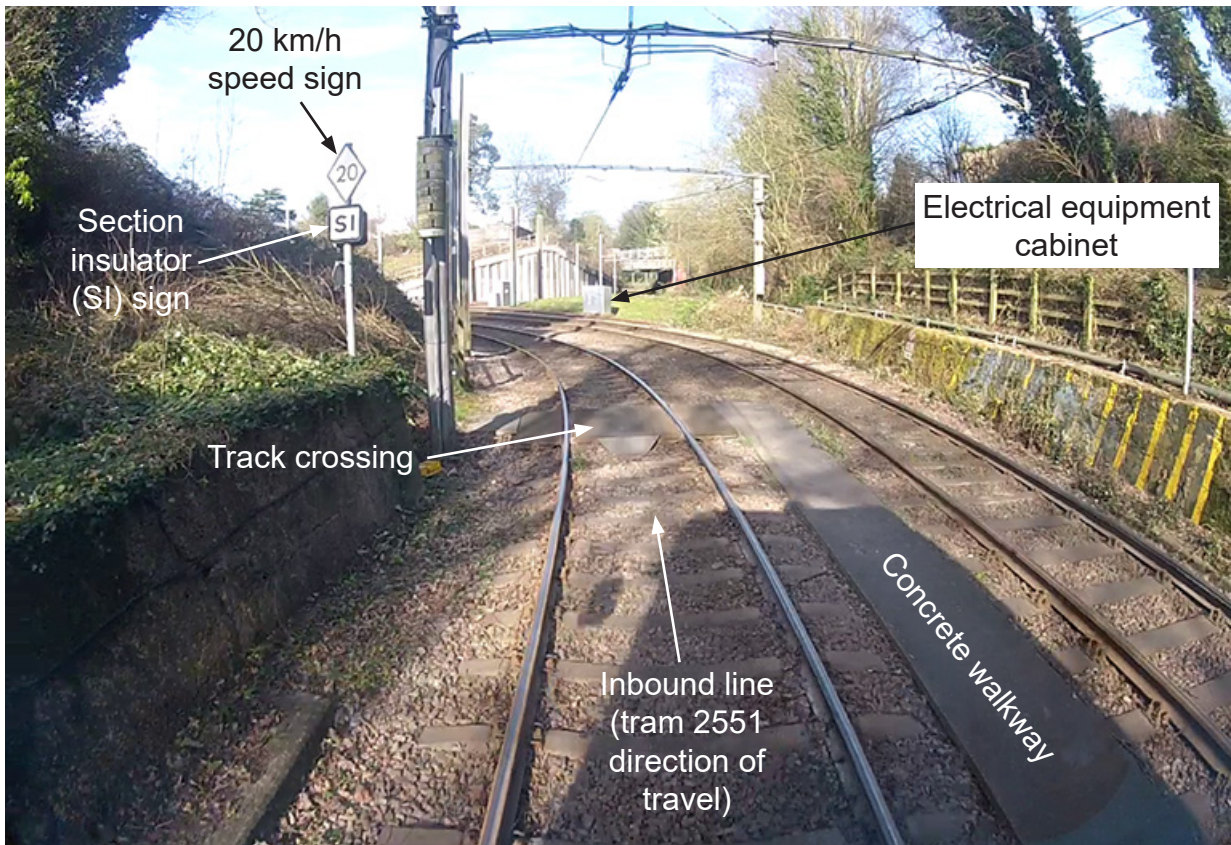

Figure 10: Approaching Sandilands south curve (from video image recorded in 2012 with distortion at image edges, courtesy TOL)

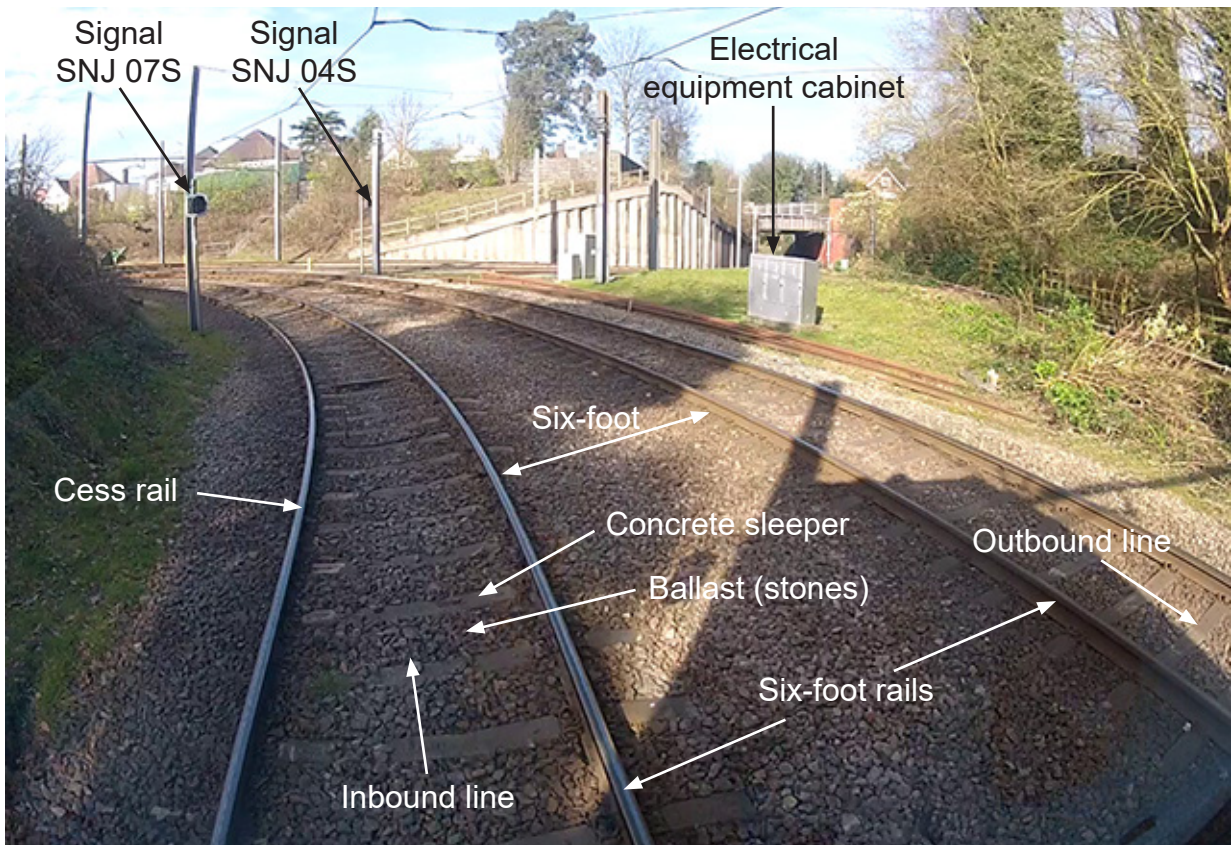

Figure 11: Sandilands south curve (from video recorded in 2012 with distortion at image edges, courtesy TOL)

- 27 Electrical power is supplied to the trams at 750 volts DC (direct current) from overhead electric wires. In the Sandilands area, these are supported by lineside masts and metalwork extending over the lines. These wires and supports are known as *overhead line equipment* (OHLE).
- 28 The track between Lloyd Park and Sandilands junction, including the curve on which the accident happened, uses conventional steel rails fastened to *concrete sleepers* laid on stone *ballast* (figure 11).

Tram involved

- 29 The vehicle involved in the accident was a Bombardier type CR4000 tram, number 2551, built in Austria in 1998 and one of the 24 trams that made up the original Croydon fleet. Each CR4000 tram comprises three vehicles (figure 3); two end vehicles fitted with a driving cab (known as the A and B end vehicles) joined by a central *articulation unit* (the C vehicle). A four-wheel bogie is provided at the outer end of both the A and B vehicles. The inner ends of these vehicles are supported by the articulation unit which incorporates four *stub axles*, each fitted with one wheel.
- 30 A CR4000 tram weighs about 36 tonnes unladen, and is 30.5 metres long. There are two double-leaf door openings on each side of both the A and the B vehicle. The passenger vehicle body side windows, and the door windows, are made of toughened glass (paragraph 312) and the driving cab windscreens are made from laminated glass (paragraph 313). Window and door details are given at paragraphs 285 (windows) and 292 (doors).
- 31 A *pantograph* fitted to the B end vehicle collects electric current from the OHLE system (figure 3) to power the tram's electric motors and control systems. The control system fitted to CR4000 trams will automatically start to limit the electrical power fed to the tram's traction motors when the tram's speed reaches 80 km/h (50 mph). Electrical power to the motors is reduced progressively as speed increases above 80 km/h, and is removed completely when a speed of 84 km/h (52 mph) is reached.
- 32 These trams are equipped with the following means of braking:
- A service brake, operated by the *traction/brake controller* (TBC, paragraph 34) is used for routine control of tram speed, for example stopping at tram stops or slowing for speed restrictions. This uses dynamic braking of either the *rheostatic* or *regenerative* type. Under some circumstances, spring-applied *friction disc brakes* operate in conjunction with the dynamic brake. Service braking provides a maximum (full service) rate of deceleration of about 1.3 m/sec². Full service braking distances relevant to this report are given in table 1.
 - A hazard brake application, sometimes referred to as the emergency brake, is also operated by the TBC and is used when rapid deceleration is needed (for example, to avoid a collision). Hazard braking deploys the *track brake* which comprises six electro-magnetic rail shoes (two on each bogie and two on the central articulation unit) which adhere magnetically to the rail head. The dynamic and friction brakes also apply during a hazard brake application and sand is deposited onto the rail head to improve rail *adhesion* (paragraph 35). Hazard braking provides a typical deceleration rate of about 2.75 m/sec². Hazard braking distances relevant to this report are given in table 1.

- The emergency plunger to the left of the driver (figure 12) initiates an emergency shutdown of the tram during which the tram is stopped by the track brake and the spring-applied friction disc brakes. This braking cannot be released until the tram has stopped.
- A push-button on the right-hand side of the driver’s control desk allows the track brake to be operated independently of other functions.

Braking type	Initial speed	Speed at start of curve	Braking distance to reach speed after brake control operated	Braking distance to reach speed with 1 to 2 seconds driver reaction time
Full service	79 km/h	49 km/h	141 to 144 metres	163 to 188 metres
Full service	79 km/h	20 km/h	203 to 207 metres	225 to 251 metres
Hazard	79 km/h	49 km/h	55 to 61 metres	77 to 105 metres
Hazard	79 km/h	20 km/h	84 to 90 metres	106 to 134 metres

The range of braking distances is based on nominal braking rates, and reflects track gradients on the approach to the curve, and possible variations in the time taken for the braking effect to build up to the maximum value. The relevance of the speeds 20 km/h and 49 km/h is discussed at paragraphs 20 and 111.

Greater distances could be required if adhesion between rails and wheels is reduced by rain, leaves and/or other contaminants as shown by RAIB testing relating to a tram accident at Shalesmoor ([RAIB Report 17/2016](#)). This means greater distances could have been required approaching Sandilands south curve at the time of the accident.

Reaction time range is based on research commissioned by TRL² indicating that, for an unexpected event requiring an immediate brake application, most car drivers will respond by applying the brakes within about 2 seconds.

Table 1: Braking distances for CR4000 trams on approach to start of Sandilands south curve assuming no loss of rail-wheel adhesion

- 33 The spring-applied friction disc brakes are also used as a parking brake to hold trams stationary, for example at tram stops, junctions and in depots.
- 34 The tram is controlled by the driver via the TBC (figures 12 and 13). The TBC incorporates a *driver’s safety device* (DSD), sometimes known as a *dead man’s handle*, the operation of which is discussed at paragraph 36. The TBC has five positions:
 - *Drive*: pushing the TBC forward into the ‘drive’ position engages the traction system and accelerates the tram. Moving the TBC further forwards through the drive position increases the rate of acceleration until the maximum acceleration rate is achieved.
 - *Cruise*: holding the TBC in the ‘cruise’ position allows the tram to maintain its current speed through automatic adjustment of the traction system. Although the ‘cruise’ position will increase and reduce power to the traction system, it does not prevent the tram’s speed from increasing on descending gradients.

² TRL Limited (TRL) is the successor to the Transport Research Laboratory. Its website, www.trl.co.uk, is a source of transport related research documents such as that referenced above. TRL also provides transport related expertise and was commissioned by the RAIB to provide specialist advice, mainly using its highway expertise, as part of the Sandilands investigation.

- *Coast/rest*: holding the TBC in the coast position allows the tram to ‘free wheel’ ie there is no traction or braking demand. This position is also used once the tram is stationary and being held on the spring-applied parking brakes.
- *Service brake*: pulling the TBC rearwards into the ‘brake’ position applies the tram’s service brakes. Moving the TBC further rearwards through the brake position increases the rate of deceleration until the maximum service braking rate is achieved.
- *Hazard brake*: pulling the TBC rearwards past the maximum service braking position and through a detent (notch) into the ‘hazard brake’ position initiates hazard braking. The hazard brake can be deactivated before the tram has stopped by moving the TBC forwards.

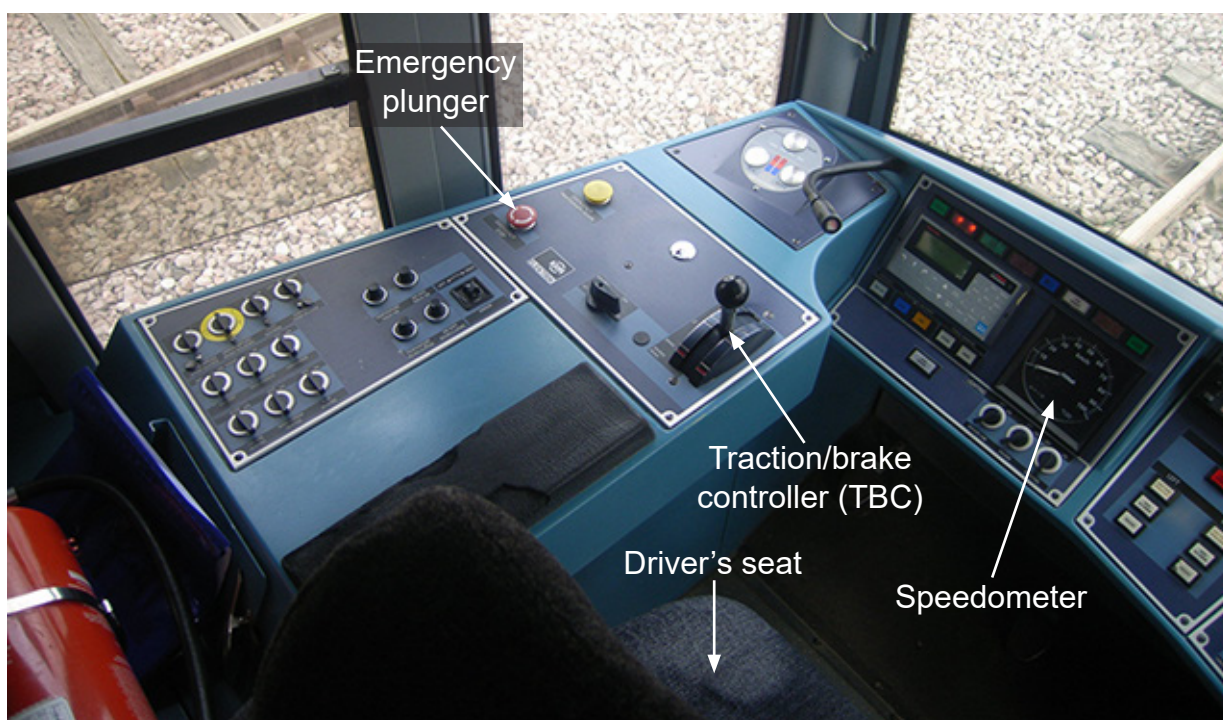

Figure 12: CR4000 driving cab and controls

- 35 A sanding system applies sand to the rail head to prevent or reduce wheel slide/slip during braking or acceleration when there is low adhesion at the wheel-rail interface. Sand is applied automatically if the hazard brake is selected or wheel slide/slip is detected by the tram’s traction and braking systems during braking or acceleration. Sand can also be applied by the driver operating a button in the driving cab.
- 36 The CR4000 tram DSD system is intended to stop the tram if the driver has become incapacitated. To prevent the DSD from intervening, the tram driver has to keep the TBC pushed down using a force between 5.5 *Newtons*³ (N) and 8.5 N. If the tram driver releases the pressure necessary to hold the TBC down, an alarm will sound for four seconds, after which the hazard brake will apply if the TBC has not been pushed down again.

³ These force values were provided to LT by Bombardier after the accident and equate approximately to 0.6 kg (1.2 pounds) and 0.9 kg (1.9 pounds). The values are typical for this type of device. Greater forces can increase the risk of discomfort/strain injury caused by maintaining the required force to prevent the system operating and applying the brakes.

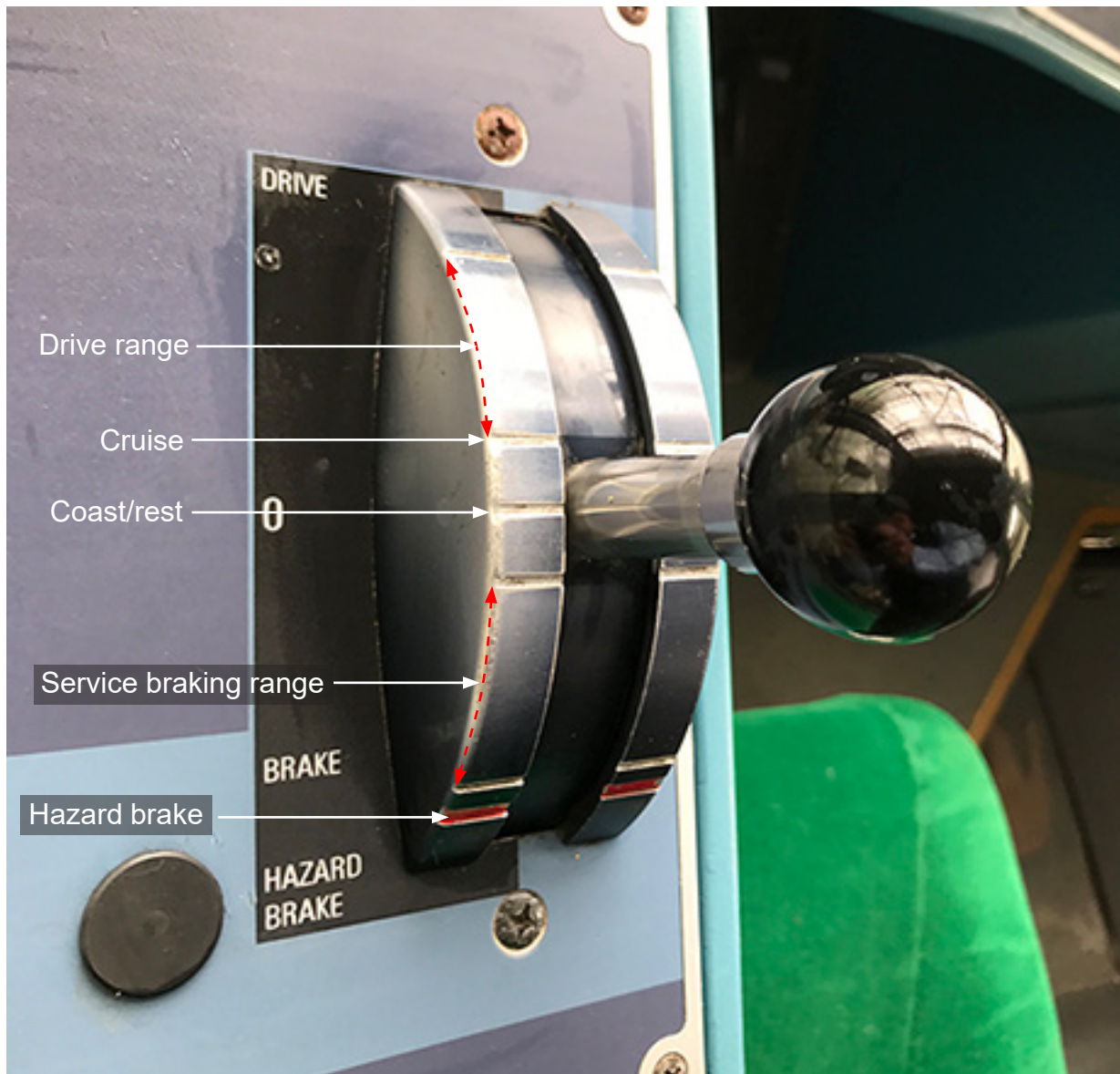

Figure 13: CR4000 traction/brake controller (the controller is shown vertically for clarity; it is in fact horizontal)

- 37 The tram was equipped with closed circuit television (CCTV) cameras giving views ahead and behind the tram, as well as internal coverage of the passenger areas. The rear facing CCTV image is displayed on a monitor visible to the driver so they can see if anyone is 'surfing' (riding on the rear tram). The tram's CCTV was not recording images at the time of the accident (paragraphs 408 to 421).
- 38 Each tram is fitted with an *on-tram data recorder* (OTDR). The OTDR records parameters such as the vehicle's speed, distance travelled⁴ and the driver's operation of the TBC, to a resolution of one whole second. The OTDR records whether the TBC is in the 'Drive', or 'Brake' positions, but it does not record the level of *traction power* or braking demanded within each position or differentiate between the 'Drive' and 'Cruise' positions. The OTDR also records the use of the hazard brake and sanding system.

⁴ Distances involving the position of the tram use information from the tram's OTDR. The accuracy of this is discussed in Appendix H.

- 39 As is normal practice for OTDR systems, older data recorded by the OTDR was being overwritten as new data became available. TOL has stated that 130 km of data (around 3.5 to 4 hours of normal tram operation) should be obtained by downloading the OTDR on these trams; the RAIB obtained this amount of journey data from tram 2551 following the accident. The tram spent a period of time dormant in the depot, so data from the evening and night of 8 November 2016 was still available, this included journeys undertaken by the tram during that time. The CR4000 trams are also fitted with processors that record data associated with the traction (drive) and braking systems. In some instances these only record data during fault conditions rather than continuously when systems are operating normally.
- 40 A dipped beam headlamp, a main beam headlamp and a combined brake/tail/indicator light unit are fitted on each side of both driving ends (figure 14). The dipped and main beam headlamps are fitted with *light-emitting diodes* (LEDs). End light repeaters, each including red and white lenses, are fitted on the side of each vehicle near the driving ends and, at night, display a light appropriate to the direction of travel. Orange side marker lights are fitted at intervals along the side of the tram.

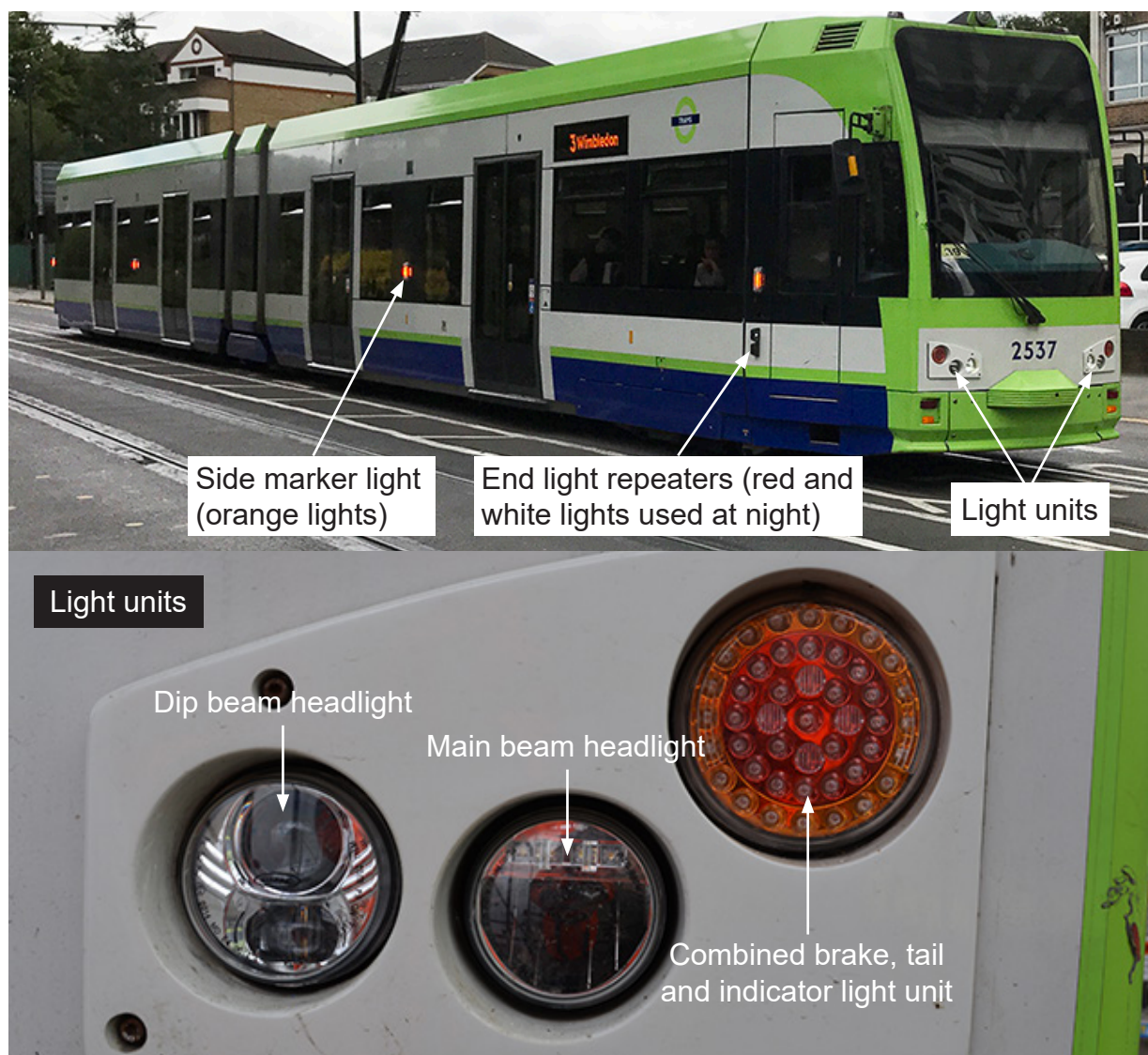

Figure 14: External lights fitted to CR4000 trams

The driver

- 41 The driver of tram 2551 joined TOL in March 2008 as a trainee tram driver. Before that he had worked as a milkman between 2006 and 2008, and as a bus driver between 1998 and 2006. At the time of the accident the driver held a clean driving licence, originally issued in April 1993. This included an entitlement to drive buses until April 2019, although this was not required in order to drive a tram.
- 42 The driver completed tram driver training and TOL deemed him competent to drive trams throughout the Croydon tram network in May 2008. At the time of the accident his competence assessments were up to date, and he was not on any special monitoring or development plans arising from concerns about his competence or medical fitness. The driver had no disciplinary action recorded against him by TOL. Tram speed checks by TOL had not identified any instances of this driver travelling above permitted limits.
- 43 Loop data (paragraph 18) shows that the driver had driven around Sandilands south curve, in both directions, many times before the day of the accident. This data records that he last drove around the inbound curve on 4 November 2016, five days before the accident when he did so twice, once at 09:53 hrs and again at 11:37 hrs. The data shows that he drove around the inbound curve on at least 693 occasions between 1 January 2015 and 9 November 2016.

External circumstances

- 44 The accident occurred at around 06:07 hrs. It was very dark and raining heavily and Sandilands south curve is in an unlit location. This combination of factors reduced the driver's view of the line ahead when compared to the same journey during daylight hours with clear visibility.

The sequence of events

Events preceding the accident

- 45 The driver stated that the night before the accident he had an uneventful night's sleep and got up at about 03:30 hrs. The driver had a drink of water, but did not have any breakfast as he was planning to eat during his break at around 09:00 hrs. He left for work early so that he could buy food for his break. Shop transaction records show that he visited a local supermarket at around 04:27 hrs.
- 46 The driver signed on for duty in Therapia Lane depot at 04:48 hrs, five minutes before the required time of 04:53 hrs. He spoke with two of the controllers and was allocated tram 2551 on *duty* reference number 112. This duty involved four return trips on services between Wimbledon and New Addington with a break from driving scheduled from 08:48 hrs to 09:48 hrs. The first part of duty 112 was to drive the 05:16 hrs service from Therapia Lane to New Addington.
- 47 Before leaving the depot, the driver checked that tram 2551 was fit for service. This check covered the general condition of the tram, including the tram's headlamps, and checking that the internal CCTV monitor (anti-surfing) display was correctly functioning.
- 48 Tram 2551 departed Therapia Lane tram stop on time at 05:16 hrs. The outbound journey to New Addington was uneventful and the tram ran approximately to time, reaching New Addington at 05:47 hrs (table 2). The driver then moved to the other driving cab and departed from New Addington on time at 05:53 hrs. The tram then called at six stops before the accident, departing from the last of these, Lloyd Park, on time at 06:05 hrs (table 3). The driver had not reported any faults or issues affecting the tram during this time. There were 69 passengers travelling on the tram when it left Lloyd Park.

Tram stop	Booked departure time	Actual departure time
Therapia Lane	05:16	05:16
Ampere Way	05:17	05:17
Waddon Marsh	05:18	05:18
Wandle Park	05:20	05:19
Reeves Corner	05:22	05:21
Centrale	05:24	05:23
West Croydon	05:26	05:25
Wellesley Road	05:28	05:27
East Croydon WB	05:30	05:30
Lebanon Road	05:32	05:32
Sandilands	05:33	05:33
Lloyd Park	05:36	05:36
Coombe Lane	05:39	05:38
Gravel Hill	05:41	05:41
Addington Village	05:43	05:43
Fieldway	05:45	05:44
King Henry's Drive	05:46	05:46
New Addington (arrival times)	05:47	05:47

Table 2: Booked and actual outbound journey running times

Tram stop	Booked departure time	Actual departure time
New Addington	05:53	05:53
King Henry's Drive	05:54	05:55
Fieldway	05:56	05:56
Addington Village	05:58	05:58
Gravel Hill	06:00	06:00
Coombe Lane	06:02	06:03
Lloyd Park	06:05	06:05

Table 3: Booked and actual inbound journey running times

- 49 After leaving Lloyd Park at 06:05:21 hrs⁵, the driver controlled the tram's speed through the 20 km/h (12 mph) speed restriction around the right-hand bend leading to the straight section of track towards the tunnels on the approach to Sandilands. He then accelerated the tram, which reached the maximum permitted speed of 80 km/h (50 mph) just before it entered the Sandilands tunnels.
- 50 About 16 seconds before the tram reached the 20 km/h speed restriction sign at the start of the Sandilands south curve, tram 2551 was approximately 340 metres from the sign, near the second tunnel gap and travelling at about 79 km/h (49 mph). Although the driver usually began to apply the tram's brake at this point to comply with the Sandilands south curve speed restriction, he did not do so on this occasion.
- 51 Approximately eight seconds after passing the second tunnel gap, and around four seconds from the exit of the tunnels, the OTDR recorded that the TBC was moved from drive, through coast and into brake, and then back through coast and into drive. The tram's speed was 79 km/h (49 mph) at this point and the entire TBC movement took around one second to complete, during which time the tram travelled 25 metres. This brief brake application was around 185 metres from the 20 km/h speed sign, but it did not reduce the tram's speed significantly.

Events during the accident

- 52 About four seconds after this brief brake application, tram 2551 exited the tunnels into heavy rain, travelling at a speed of about 78 km/h (48 mph). The exit is around 95 metres from the 20 km/h speed sign located at the start of the curve into Sandilands junction. Around one second after exiting the tunnel, the driver shut off traction power and applied the service brake. As the brake was applied, tram 2551 was around 57 metres from the 20 km/h sign at the start of the curve and was still travelling at about 78 km/h (48 mph). Around a second after the driver applied the service brake, the OTDR records that sanding was demanded. The RAIB has concluded that this sanding was probably triggered when the tram's wheel slip/slide protection system responded to the adhesion available at the wheel-rail interface.

⁵ Times in hours:minutes:seconds as recorded by the tram's OTDR.

- 53 Tram 2551 passed the 20 km/h speed sign and entered the Sandilands south curve when travelling at about 73 km/h (45 mph). Shortly afterwards, at 06:07:01 hrs, the tram began to overturn onto its right-hand side. The driver reported that he did not have time to react to entering the curve before he was tipped out of his seat as the tram overturned.
- 54 Some passengers reported that the tram began to shake before it turned over. As the tram overturned, passengers who had been sitting and standing inside the tram were thrown against each other, against the internal fittings and against the tram's windows and doors. Around 34 of the passengers were fully or partially ejected through the tram's windows or doors.
- 55 The tram came to rest after travelling for about three seconds and covering a distance of about 27 metres from the place where it left the rails. Approximately 18 metres of this distance was while the tram was rolling onto its side. It then slid on its side for the remaining 9 metres (figure 15). It had struck various items of lineside equipment and was lying across the outbound curve to Lloyd Park and the inbound curve from Addiscombe (figure 4).

Events following the accident

- 56 When the tram stopped on its right-hand side, it was in total darkness because none of the tram lights were illuminated (paragraph 345). Many passengers started using their mobile phones as torches to see in the darkness. Passengers reported being shocked, confused and distressed by what had just happened.
- 57 The driver of tram 2551 had been thrown from his seat and reported being momentarily unconscious. He was roused by passengers banging on the door between the passenger saloon and the driving cab and trying to shine light from their phones into his eyes. The driver tried to call the control room using the emergency call facility on the tram's radio system, but the call did not connect, although the incoming emergency call appeared on a controller's display in TOL's control room at Therapia Lane. While a line controller attempted to call tram 2551 back, the driver found the mobile phone allocated to tram 2551⁶ and called control. He said that the tram was on its side, people were injured, and help was needed urgently. Control room staff then called the emergency services. During this time some passengers had also used their mobile phones to call the emergency services.
- 58 Another tram, number 2554, had just departed from Sandilands tram stop heading towards Sandilands junction and Elmers End when the accident occurred. The driver of tram 2554 saw a flash of light ahead and thought that something had fallen onto the OHLE because, at the same time, tram 2554 lost power. He called TOL control to report this. TOL control was already aware of the loss of power in the area as alarms had sounded in the control room when OHLE damage caused by the accident resulted in circuit breakers switching off the power supply to the Sandilands junction area. One of TOL's line controllers asked the driver of tram 2554 to walk towards Sandilands junction to see if he could identify a problem with the OHLE.

⁶ TOL does not issue its drivers with mobile phones. A mobile phone is provided on each tram for use if the main tram radio system fails.

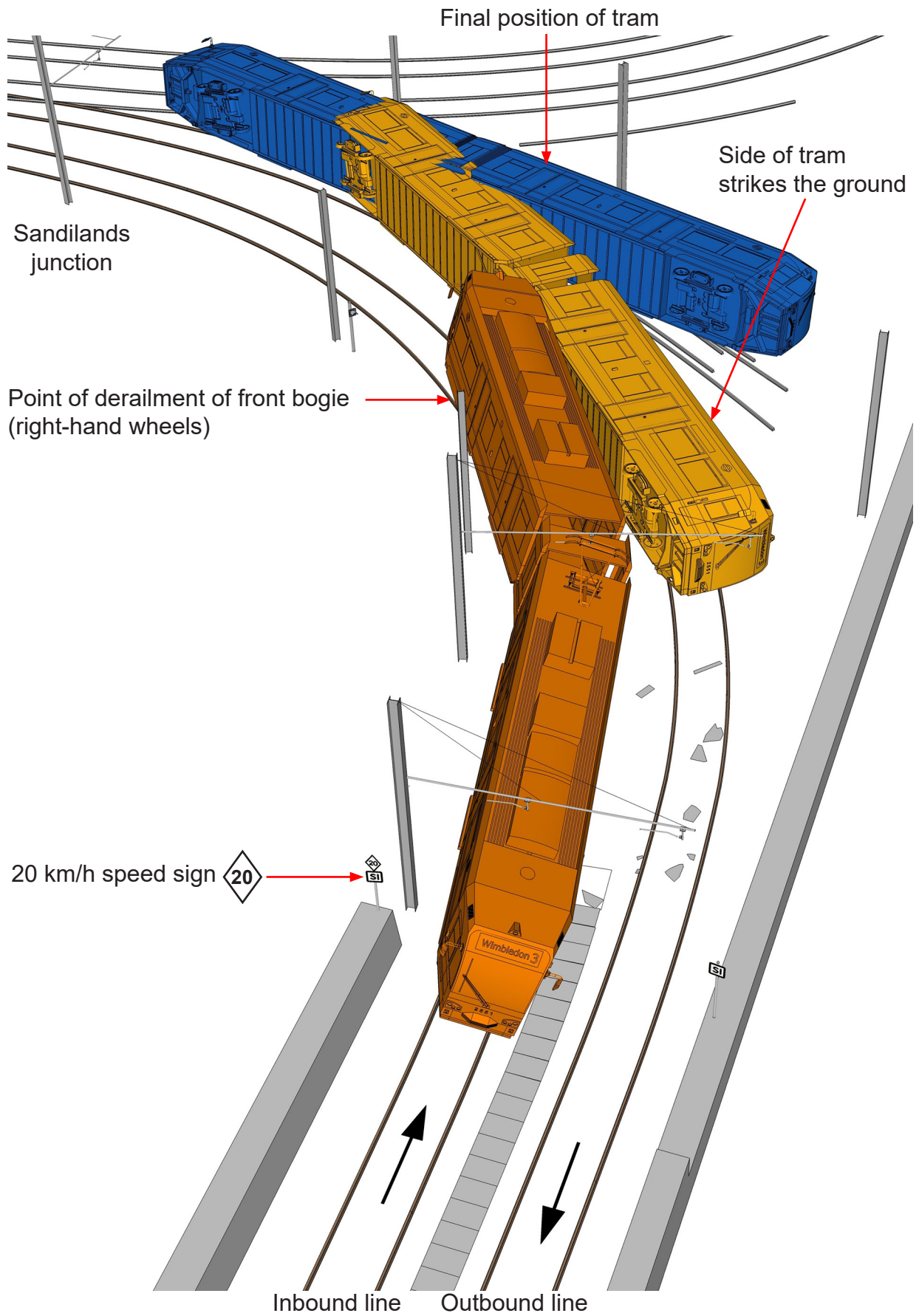

Figure 15: Accident sequence

- 59 Some passengers tried to force open some of the doors on the left-hand side of the tram, which were now above their heads. They succeeded in opening one pair of doors, but did not escape through this opening because of the fear of electric shock from the OHLE wires above the tram. These passengers were unaware that the power supply to the OHLE in the area had been automatically switched off.
- 60 When the driver of tram 2554 walked to Sandilands junction he found tram 2551 lying on its side. He, and others in the tram, began making a hole in the front windscreen so that people could escape from inside the tram. Initially they used a fire extinguisher and then began using a *points bar*, a heavy metal bar kept in the tram cab and used to operate points.
- 61 The first emergency response, two officers from the Metropolitan Police, arrived near Sandilands tram stop at about 06:12 hrs, within about two minutes of the first 999 call. They walked first to tram 2554 and then onwards to see tram 2551 lying on its side in the distance. They informed their control room who passed this information to the London Fire Brigade, London Ambulance Service and the British Transport Police, all of whom had begun dispatching resources to Sandilands tram stop based on earlier phone calls. The driver of tram 2554 stated that, by the time the police officers arrived at the tram, three people had exited the tram through the small opening that had been created in the front windscreen.
- 62 One police officer helped the tram drivers enlarge the hole in the front windscreen. Together, they made the hole large enough for more passengers to leave the tram (figure 16). Meanwhile, other police officers were arriving and three made their way to the rear of the tram to try and break the rear windscreen. Several minutes later, the rear windscreen was successfully breached.



Figure 16: Front of tram with windscreen removed to evacuate passengers (initial hole formed by tram drivers/police officer, remainder removed by fire service)

- 63 From about 06:16 hrs, responders from the British Transport Police, London Fire Brigade, the London Ambulance Service and specialist medical staff began to arrive at Sandilands, and a short while later they arrived at tram 2551 to rescue and treat the passengers who were either trapped, or unable to get themselves off the tram because of their injuries. The passengers who were able to walk, aided and unaided, were taken to tram 2554 which was being used for the initial medical assessment of casualties. Passengers were then taken to hospital by bus and ambulance. The fire service cut away parts of the tram and used specialist equipment to raise the tram. The last surviving trapped passenger was freed from tram 2551 at around 08:16 hrs.
- 64 Seven passengers were fatally injured during the accident, 19 suffered serious injuries and 42 received minor injuries. The tram was extensively damaged and there was significant damage to the track, OHLE and signalling equipment.
- 65 The RAIB was advised of the accident at 06:42 hrs and immediately deployed seven people and two support vehicles to the accident site. The RAIB concluded its on-site investigations at 00:30 hrs on 12 November 2016 and subsequently issued an Urgent Safety Advice (Appendix F) regarding the need for additional signage at the curve before the line was reopened. This was installed by LT before services resumed through Sandilands to Beckenham Junction, Elmers End and New Addington on 18 November 2016.

Key facts and analysis

Background

Tramways

- 66 With the exception of Blackpool and some minor/*heritage* systems, tramways disappeared from the UK in 1962. Tramways began to return to the UK from 1992 when Manchester Metrolink became operational. Further tramways were opened in Sheffield in 1994, Birmingham in 1999, Croydon in 2000, Nottingham in 2004 and Edinburgh in 2014. Unless noted otherwise, this RAIB report is referring only to these seven tramways and not to minor/*heritage* tramways that operate in the UK.
- 67 Trams that operate on current UK tramways are often referred to as second generation trams. These trams operate at higher speeds and have more effective brakes when compared to the trams which operated on UK tramways until the 1960s (known as first generation trams).
- 68 The Croydon tramway was authorised by the Croydon Tramlink Act 1994 and was constructed on existing roads, newly acquired land and former railway lines. It opened in May 2000 after HMRI approved the tramway as required by the then current Railways and Other Transport Systems (Approval of Works, Plant and Equipment) Regulations 1994 (ROTS). This approvals process did not require HMRI to assess the operational aspects of the Croydon tramway.
- 69 In 1997, HMRI published guidance for those involved in the design and construction of tramways, entitled 'Railway Safety Principles and Guidance Part 2 Section G: Guidance on tramways' (RSPG-2G). This was based on experience gained during the construction and operation of the tramways in Manchester and Sheffield and replaced earlier requirements (eg guidance setting out requirements for first generation tramways issued by the Ministry of Transport in 1926). RSPG-2G was updated by ORR in 2006 and then issued with the same title ('Guidance on tramways') but designated as Railway Safety Principles 2 (RSP2). The documents related primarily to design requirements rather than operational matters. In 2015 a *memorandum of understanding* between ORR and UKTram transferred lead responsibility for reviewing and updating RSP2 to UKTram with ORR retaining the final decision concerning the updated content.
- 70 RSPG-2G and RSP2 describe tramway operation as:
- on-street where the part of the highway⁷ occupied by the tramway rails can be used by road vehicles or by pedestrians;
 - segregated where the part of the highway occupied by the tramway rails may be crossed by pedestrians but is not normally shared by road vehicles; and
 - off-street where the tramway is completely separated from the highway and the tramway alignment is separate from any highway [the situation at the accident location].

⁷ Highway in this context was said to include a carriageway, bridleway, cycle track, footpath, land on the verge of a carriageway or between two carriageways and any other place to which the public has access.

71 In order to operate 'on-street' RSPG-2G and RSP2 noted that trams are generally subject to the requirements of the Road Traffic Regulation Act 1984 and the Road Traffic Act 1988. Some regulations do not apply to trams, or are modified for trams where this is shown in the Tramcars and Trolley Vehicles (Modification of Enactments) Regulations 1992.

Tram line-of-sight driving

72 The Croydon tramway, in common with all UK tramways, operates on the *line-of-sight* driving principle⁸. This is used in combination with 'route knowledge': that is, before driving unsupervised, tram drivers must have learnt about speed restrictions, junctions, crossings and other features on the lines they drive over. Signals are only provided where necessary to regulate tram movements at tramway junctions and at some locations where roads cross the tramway (paragraph 18). They are not provided to regulate the spacing between trams.

73 With regard to line-of-sight driving, RSP2 states:

'A tram should be able to stop before a reasonably visible stationary obstruction ahead from the intended speed of operation, using the service brake.'

'On any part of the system, the permitted speed of operation of the vehicles is limited to that which enables the driver of any such vehicle to stop it within the distance he can see to be clear ahead.'

74 TOL tram drivers are trained on the principles of line-of-sight driving during their initial training. TOL training lesson TLP 0025 'The system of tram control' introduces the principles of line-of-sight driving with a presentation stating:

- *'You may need to respond by taking avoiding action, e.g. braking.'*
- *'Remember that a tram is a guided vehicle and you cannot steer out of the way.'*
- *'Your tram should be able to stop before a reasonably visible stationary obstruction ahead from the intended speed of operation, using the service brake.'*

75 Tram drivers are taught that there are three categories of hazard:

- *'static hazards including track curves, highway junctions, tramway signals and footpath crossings;*
- *moving hazards including pedestrians, road vehicles and other trams, including trams that are stationary; and*
- *environmental hazards including rain, darkness, fog and bright sun.'*

76 Tram drivers are taught that an essential part of hazard recognition is 'scanning' the view ahead. TOL training lesson TLP 0025 says that scanning includes the ability to be aware of your surroundings and to look all around for clues, and that 'just staring ahead is not enough'. On approaching a hazard drivers are taught to reduce power or apply the brake, and to constantly reassess the hazard. Drivers are told the hazard brake is the most effective way to stop a tram.

⁸ There is a localised exception where signals, similar to railway signals, remain on parts of the Manchester Metrolink system.

- 77 In poor visibility drivers are taught to ‘keep a good lookout’ and regulate the speed of the tram so they can stop short of any obstruction and respond to the aspect displayed at signals. The emphasis during training is on driving at a speed from which the tram can stop to avoid an incident or accident, taking into account environmental and local conditions.
- 78 TOL training lesson TLP 0023 ‘Stopping distances’ introduces trainees to the braking characteristics of trams. The lesson includes a description of the braking systems fitted to the trams and the relative effectiveness of them. Trainees are told that trams take much longer to stop than cars from comparable speeds and that the hazard brake can stop a tram in half the distance of the service brake. Examples of stopping distance are given from various speeds when using the service brake and when using the hazard brake. The presentation used for teaching states that the hazard brake ‘Must always be used to avoid a collision – WITHOUT EXCEPTION’. During their training, tram drivers practise stopping the tram using the hazard brake. They also practise using it during biennial assessments (paragraph 82).
- 79 Trainees are reminded of the requirements of the Highway Code, including ‘Drive at a speed that will allow you to stop well within the distance you can see to be clear’.
- 80 Trainee drivers drive the routes under the guidance of trainers. During this time trainee tram drivers gain experience of the braking performance of the tram and the location of speed restrictions, signals, junctions and tram stops. Trainee tram drivers now also gain route knowledge from watching route DVDs while trainers provide spoken guidance on hazards. DVDs were introduced into the training programme after the driver of tram 2551 completed his training (this change is not relevant to the accident).
- 81 TOL does not prescribe *braking points* at which drivers should apply a tram’s brakes on the approach to speed restrictions. Although guidance is given by trainers to trainees learning to drive a tram, it is then left to individual tram drivers to decide where they should begin to apply the tram’s brakes. After the accident, TOL explained to the RAIB that:

‘[a location to apply the brakes] cannot be fixed as braking will depend on a number of variable factors that a driver has to take into account. For this reason great emphasis is placed on drivers knowing the stopping distances of the vehicles being driven. The theory of stopping distances is presented in the classroom and then practised whenever a tram is driven when under supervision of a trainer.’

Tram driver competence and performance management

- 82 TOL procedure TR0002 ‘Driver training and competence’ describes the competence management processes applied to tram drivers. For experienced tram drivers, such as the driver of tram 2551, the process details the following methods of assessment to check the competence and performance of tram drivers:
- Ride checks: These are carried out as random events or can be planned. They are often used to check a driver’s performance in cases where a complaint about their driving has been made. They can be carried out covertly or from the driving cab.

- Performance assessments: These are carried out annually and can additionally be carried out following more serious complaints about a driver's performance. The assessment is in two parts: a covert ride in the tram without the driver's knowledge and an in-cab assessment with the driver. When this type of assessment is carried out as the annual assessment, it must include a round-trip to New Addington, or a round trip to both Elmers End and Beckenham Junction. Over a two-year period the whole of the Croydon tramway must be covered.
 - Biennial assessments: This assessment includes retraining and assessment of out-of-course situations such as tram failures and emergency procedures, and a general assessment of tram driving skills and knowledge. Emergency stopping exercises using the hazard brake are also practised.
- 83 TOL does not use OTDR data in its tram driver competence management system. TOL stated that this is because of the difficulty of matching OTDR data to specific geographic locations and the limited data storage capacity on the trams (3.5 to 4 hours of tram operation, paragraph 39). TOL explained that limited data storage, in conjunction with the need for a tram to be in the Therapia Lane depot when downloading takes place, means that only evening shifts could be monitored unless a tram is withdrawn from service during the day. There is no reference in TOL procedure TR0002 'Driver training and competence' to the use of OTDR data in checking compliance with driving standards.
- 84 TOL procedure SM021 'Driver monitoring' describes the process for supporting and managing drivers who have been involved in an incident, such as releasing the doors on the wrong side of the tram, failing to call at a tram stop or being affected by an event such as an assault or personal problem. Points are allocated to drivers involved in such incidents and events and drivers are categorised by the total number of points allocated to them:
- Category U (0 to 14 points): generally no additional monitoring unless a specific action plan has been put in place following an incident or there is a verified complaint about a driver's performance.
 - Category C (15 to 19 points): the driver will have a six month action plan subject to review at least every two months.
 - Category B (20 to 34 points): the driver will have a twelve month action plan subject to review at least every two months.
 - Category A (35 points and above): a senior manager will determine an individual twelve month action plan subject to review at least once a month.
- Points are reduced as deemed appropriate following periodic performance reviews.
- 85 The driver of tram 2551 was a category U driver with a zero points allocation.

- 86 In July 2014, LT published a report of an audit it had undertaken looking at the competence and fitness of TOL's tram drivers. The report concluded that the competence and fitness of TOL's tram drivers was 'well controlled' and included the following statements:
- *TOL's documented Safety Management System (SMS), including competence, fitness and fatigue of employees, was being effectively managed.*
 - *The training and ongoing monitoring of tram operators' competence and fitness was being managed.*
 - *Routine and random drugs and alcohol testing of tram operators was being managed.*

Medical fitness

- 87 TOL procedure SM 0008 'Fitness standards (safety critical work)' specifies the minimum medical fitness standards required for tram driving and the frequency of periodic medical assessments. Medical examinations include vision, hearing, an electrocardiogram (ECG), blood pressure check, screening for the presence of drugs and alcohol and a general assessment of health and wellbeing. Unless required for a particular reason, tram drivers have medical examinations at frequencies of:
- every 5 years until age 50 years;
 - at the age of 54, 56, 58, 60, 62; and
 - annually for staff aged 63 years and over.
- 88 The driver of tram 2551 last attended a periodic company medical, which included screening for the presence of drugs and alcohol, on 9 January 2013 and was declared 'fit for continued employment'. Post-accident medical examinations are described at paragraph 125. As the driver was under 50 years of age, he was next due to attend a company medical by January 2018.
- 89 TOL procedure SM0018 'Alcohol and drugs; prescribed and proprietary medication, substances of abuse' details TOL's alcohol and drugs policy and the associated responsibilities of both TOL and its staff, including tram drivers. Procedure SM0018 defines the processes needed to comply with the requirements of the Transport and Works Act 1992, including random and post-incident screening for the presence of drugs and alcohol. Procedure SM0018 also requires TOL to supervise staff when they book on for duty to check if any person appears to be under the influence of drugs or alcohol. This check is done by the line controllers or duty managers in the control room making a judgement on the appearance and behaviour of the driver.
- 90 TOL is required by procedure SM0018 to carry out random drugs and alcohol screening on its staff. TOL records show that the driver of tram 2551 was randomly screened for the presence of drugs and alcohol on 16 January 2013, 1 July 2014 and 26 November 2015; on all these occasions the driver was found to be compliant with requirements.

RAIB questionnaire

91 The RAIB sent a personally addressed questionnaire to each of TOL's tram drivers in April 2017. It sought information about tram driving and the management of tram drivers in a format which did not require drivers to identify themselves when replying. Of the 146 questionnaires sent out, 59 completed questionnaires were returned; a return rate of 40%. The information gathered has been used in the RAIB's investigation and is included in this report where relevant. The RAIB recognises that there are limitations in this form of evidence gathering. For instance, some of the responses may have been influenced by hindsight and actions taken by the tramway following the accident. There is also an element of self-selection in the sample of drivers, meaning that the responses might not be representative of all drivers (ie those who felt motivated to respond may have more strongly held views than others). The questions were designed to provide information in specific areas; they were not intended to provide an overall assessment of TOL's safety culture.

Accident rates associated with the operation of UK tramways

92 Table 4 provides data to enable a comparison of the tramway sector with the overall railway industry. This shows that although the total route length of UK tramways is only 1.4% of the total length of all rail routes, 3% of all passenger journeys by rail during 2016-17 were by tram.

	National network (main line)	London Underground	Other metro type systems	Heritage	Tram	Tram as % of total
Passenger journeys (millions)	1,700	1,378	171	16	100.6	3%
Route km	15,799	402	126.4	917	240	1.4%

Table 4: Comparative data for rail and tram sectors (figures are for 2016-17)

93 Table 5 provides information on fatal accidents in Great Britain involving trams, main line trains and road coaches/buses. Rail and tram data has been compiled from the RAIB's records of accidents notified in accordance with the Railways (Accident Investigation and Reporting) Regulations 2005, statistics published by ORR (www.orr.gov.uk) and RSSB's annual Safety Performance Report for 2016/17 (www.rssb.co.uk). The road data is published by the Department for Transport (www.gov.uk/government/organisations/department-for-transport) as the National Road Traffic Survey, and as STATS19 data sets, compiled from police reports of road accidents causing injury.

Type of accident (excludes trespass, assault and suicide)	Data for 10 year period from April 2007 to April 2017				
	Fatalities	Fatal accidents	Fatalities per route km	Fatal accidents per million bus/coach/tram kilometres	Fatal accidents per million passenger journeys
Tram accidents notified to the RAIB excluding the accident at Sandilands junction (from RAIB and ORR statistics)	15 (11 pedestrians + 3 cyclist + 1 bus passenger)	15	0.08	0.094	0.017
Tram accidents notified to the RAIB including the accident at Sandilands junction (from RAIB and ORR statistics)	22	16	0.12	0.100	0.025
Accidents on national network (from RSSB Annual Safety and Performance report and ORR statistics)	155 (1 person travelling on a moving train, remainder mainly level crossing users or people at stations)	152	0.01	0.030	0.011
Accidents involving buses and road coaches (from DfT ⁹ STATS19 data and National Road Traffic Survey)		755		0.016	0.015
Notes: Route kilometres averaged over 10 year period Some data sets do not cover all years, estimates based on available data used where necessary					

Table 5: Fatal accidents on tramways, railways and buses/road coaches in Great Britain (April 2007-April 2017)

94 The data shown in table 5 indicates that the number of fatalities per kilometre of route and per passenger journey is higher for tramways than for the national rail network. This is not unexpected given that tramways travel through urban areas, and have a much higher frequency of locations at which pedestrians are required to cross the track (the majority of tramway fatalities involved collisions between trams and pedestrians). The data also shows that the number of fatal accidents per kilometre travelled in Great Britain is higher for trams than for buses and road coaches. However, fatal accidents per passenger journey on trams were similar to those of buses and coaches until after the Sandilands accident.

⁹ DfT: Department for Transport (<https://data.gov.uk/dataset/road-accidents-safety-data>).

Identification of the immediate cause

- 95 **The tram overturned because it was travelling too fast to negotiate the curve.**
- 96 Evidence that the tram overturned as it left the rails on the inbound line of Sandilands south curve is provided by *witness marks* and the RAIB's analysis (figure 17 and paragraph 102). Marks on the right-hand rail head of the inbound line showed that the right-hand wheels of the leading vehicle of the tram were lifted onto, and over, the right-hand rail head around 21 metres beyond the 20 km/h speed sign located at the start of the left-hand curve. Evidence that the articulation unit and rear bogie left the rails at about the same time is provided by two sets of witness marks. Damage to the right-hand end of sleepers about 14 metres after the speed sign was caused by the right-hand wheel(s) of the articulation unit. Scuff marks on the track crossing near the speed sign and damage to the adjacent concrete walkway, all to the right-hand side of the rails, were caused by the right-hand side of the rear bogie scuffing the crossing surface and the rear of the tram body, possibly the right-hand rear *jacking point*, striking the concrete.
- 97 The absence of marks on the left-hand rail, and between the rails, in this area indicates that the left-hand wheels lifted vertically off the left-hand rail and then remained in the air. This is consistent with the tram overturning to the right.
- 98 Before the accident journey on the morning of 9 November 2016, tram 2551 passed around the outbound Sandilands south curve at around 05:33 hrs that morning, and had last passed around the inbound Sandilands south curve at 21:59 hrs the previous night. In total, tram 2551 had passed around this inbound curve nine times on 8 November. No drivers had reported any mechanical problems with the tram, or any problems with its ability to negotiate the curve during these journeys.
- 99 Tram 2551 was the fifth tram to approach the inbound Sandilands south curve on the morning of 9 November; the previous tram passed around the curve 14 minutes earlier. The drivers of the four previous trams had not reported any track irregularities, for example, bumps or lurches on the approach to the south curve.
- 100 After the accident, the RAIB surveyed the track at the site of the accident and on the approach to it and concluded that no track faults or irregularities caused or contributed to the accident. The type of rail and sleeper, and the absence of a *check rail*, were not significant factors in the accident for reasons explained at paragraph 113.
- 101 There was no evidence of any OHLE defects on the approach to, or around the inbound south curve approaching Sandilands junction. None of the four drivers who had travelled around the curve on the day of the accident before tram 2551 had reported any OHLE issues in this area.

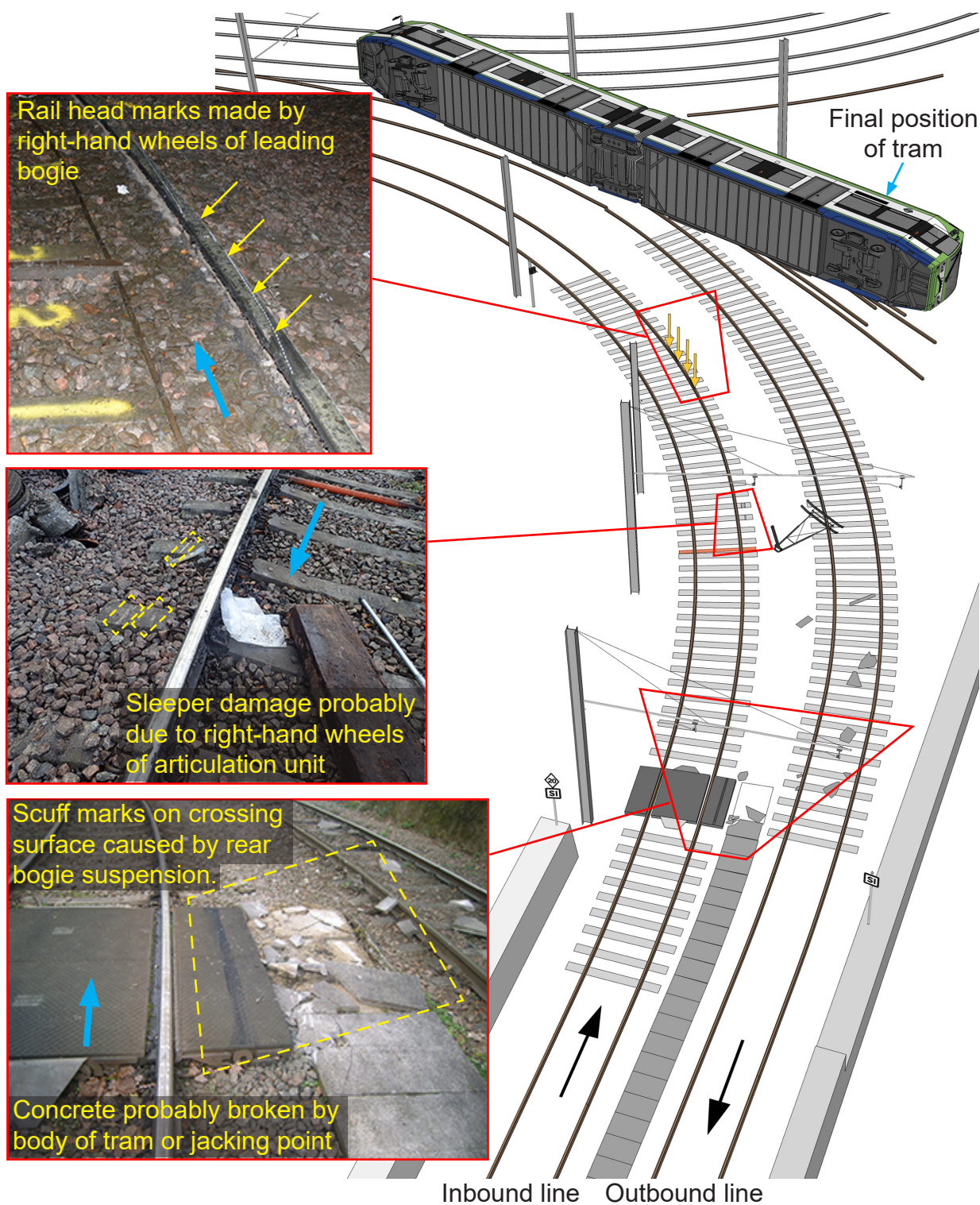

Figure 17: Marks indicating position tram derailed (blue arrows in photographs indicate tram's direction of travel)

Initiation of overturning

- 102 At the request of the RAIB, Bombardier Transportation carried out a *dynamic simulation* of the tram approaching Sandilands south curve at various speeds to establish the circumstances in which derailment and/or overturning of the tram would be expected. The simulation used specialist software which models the *dynamic performance* of railway vehicles and their resistance to derailment.
- 103 A representative tram model was created using data taken from the 'Dynamics Report for the Croydon Tram', produced by Faculté Polytechnique de Mons, in September 1997. This report had been produced at the time of the original approval of the tram design. The tram model represents the two end vehicles, the articulation unit and the joints between these modules. These joints are modelled to capture the effect of movement of one module on the adjacent one, including the transfer of *roll* (rotation about a longitudinal axis) between these modules.
- 104 The *bogies* were modelled with all their relevant suspension components. All suspension stiffnesses were taken as nominal design values. The wheelsets of the leading and trailing bogies have conventional axles whereas the wheels of the articulation unit are mounted on independent stub axles. This was represented accordingly in the model.
- 105 The mass, centre of gravity and inertia of the tram were adjusted to account for the passenger loading. The tram model was validated by ensuring that the *natural frequencies* of the model matched the natural frequencies quoted in the original dynamics report. The wheel profiles used in the dynamic simulation were as measured on the actual tram. Figure 18 shows the tram model.
- 106 The track model was based on the design geometry in terms of alignment, curvature, gradient and *cant* as described in the original construction drawings. No irregularity was included in the simulation model as no significant irregularities were found in the track surveys (paragraph 100). The *rail profiles* used in the dynamic simulation were as measured on site.
- 107 The first analysis was aimed at recreating the derailment conditions. The tram model was run on the track model at a speed of 73 km/h (45 mph), the speed at which the tram was approaching the curve. The simulation was run separately with four different values for the *friction coefficient* at the wheel-rail interface. Values of 0.1, 0.2, 0.3 and 0.4 were used and represented a range of adhesion conditions from wet and greasy to dry and clean.
- 108 The heavy rain meant that rails outside the tunnels would have been wet and this would have reduced the available adhesion (friction) at the rail-wheel interface. There is no evidence that leaves affected adhesion. No significant leaf contamination was observed when the RAIB inspected the rails (figure 20), and material swabbed from the rail head by the RAIB, when tested, was found to contain no leaf matter. Grease was being dispensed from a *flange lubricator* about 8 metres before the 20 km/h sign at the start of the curve, and then distributed along the curve by tram wheels, in order to reduce rail wear from contact between the *wheel flange* and the tightly curved rail. Evidence of reduced adhesion is supported by data from the OTDR, which showed that the tram's sanding system had been activated on the approach to the curve (paragraph 35), shortly before reaching the flange lubricator.

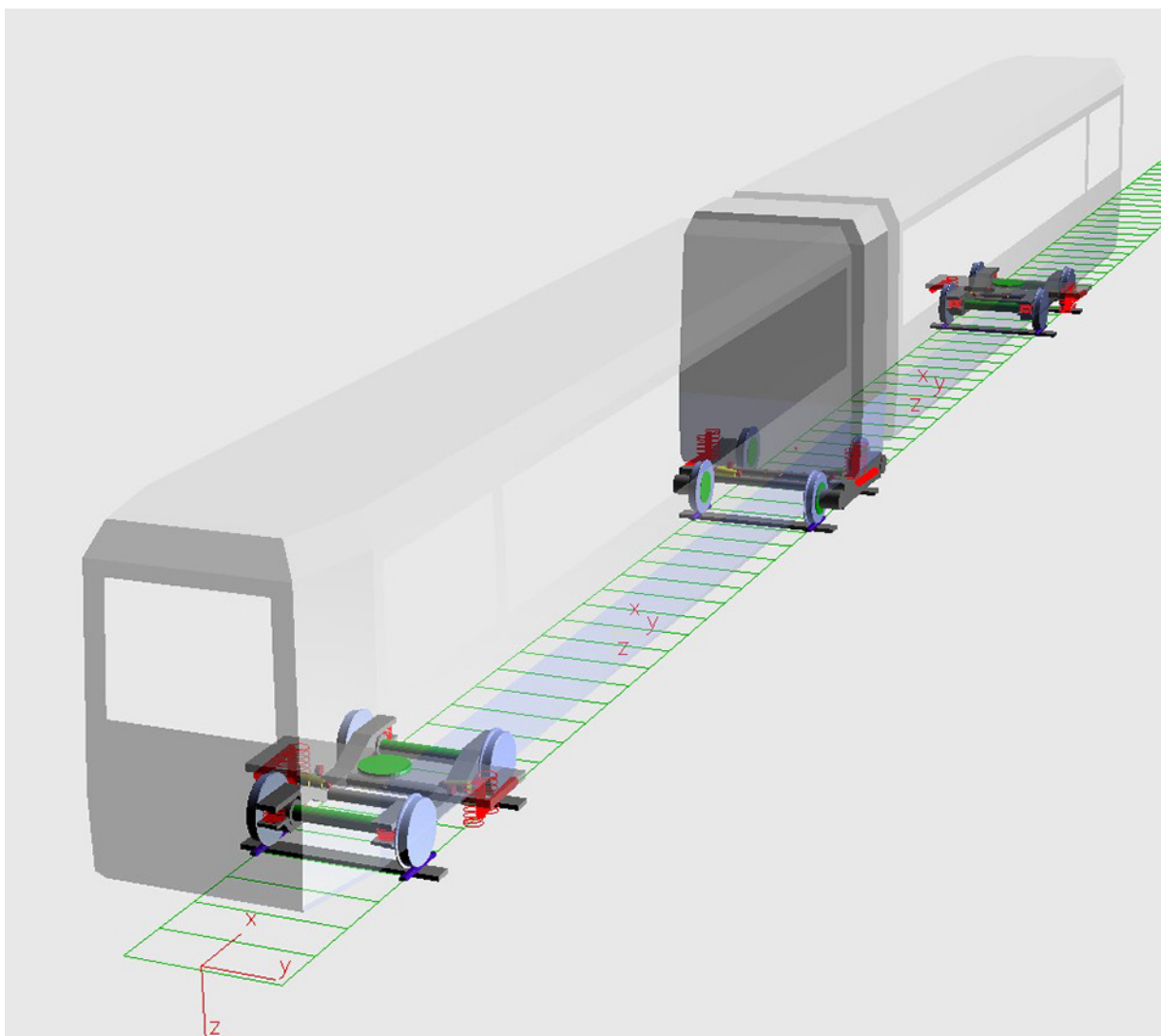

Figure 18: Tram model used for dynamic simulation (image courtesy of Bombardier Transportation)

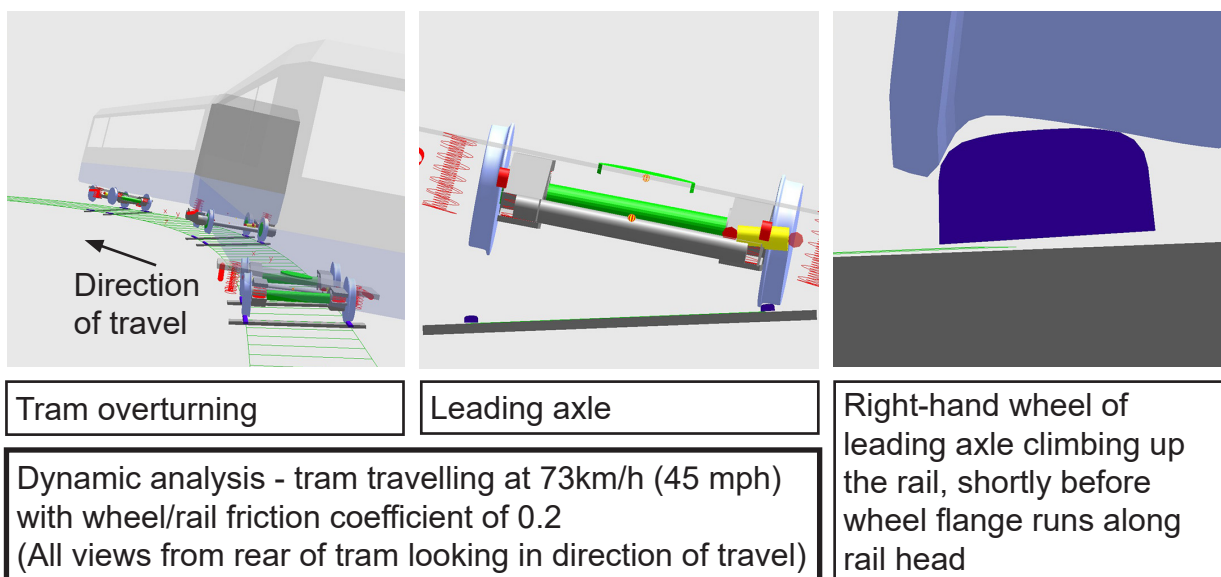

Figure 19: Tram overturning in dynamic simulation (images courtesy of Bombardier Transportation)



Figure 20: Inbound line between tunnels and speed sign six and a half hours after the accident. No evidence of significant leaf contamination on the rail head.

109 Analyses with the lower values of friction coefficient (0.1 and 0.2) showed an *overturning derailment* taking place approximately where the derailment marks were seen on the track. For the higher values of friction coefficient (0.3 and 0.4), the analysis gives a *flange-climbing derailment* at a location earlier in the curve than had been identified by the derailment marks observed on the track (paragraph 96). These results showed that the model gave results consistent with actual tram behaviour when used with a friction coefficient of 0.1 or 0.2 (0.2 or less is compatible with the conditions observed at the accident site). The results associated with a friction coefficient of 0.2 were used for the remaining analyses described in this report.

110 Figure 19 shows a pictorial representation of the output of the simulation in which the tram overturns when travelling at 73 km/h (45 mph) with a friction coefficient of 0.2. As the tram enters the curve, the lateral acceleration increases and induces roll on the vehicles. At the point shown in figure 19, the roll angle on the leading wheelset is approximately 13 degrees and the roll angle for the leading vehicle is similar. As the leading vehicle rolls, the intermediate and trailing vehicles follow it into roll. The simulation stops as the right-hand wheel starts sliding on the top of the right-hand rail.

111 The model was then run for various tram speeds to determine the minimum speed at which the tram would overturn with a friction coefficient of 0.2. Table 6 shows the results of the various simulations. The simulations demonstrate that the theoretical minimum speed at which a tram will overturn on the inbound Sandilands south curve in these conditions is approximately 50 km/h (31 mph)¹⁰. This is significantly in excess of the maximum permitted speed of 20 km/h (12 mph) around this curve. As the tram entered the curve at 73 km/h (45 mph) and had slowed to 70 km/h (43 mph) when it left the rails, both speeds were considered and shown to result in overturning. Taken together the various analyses showed that, when the tram entered the curve at about 73 km/h (45 mph) overturning was inevitable.

Speed (km/h)	Outcome
20-44	Tram successfully negotiates the curve.
45-48	Tram successfully negotiates the curve but the left-hand wheels on the articulation unit are fully unloaded.
49	Tram successfully negotiates the curve despite all left-hand wheels being fully unloaded. There is insufficient curve length to achieve overturning.
50 -73	Overturning.

Table 6: Effect of tram speed on overturning

112 The RAIB cross-checked the output of this simulation by carrying out a simple calculation to determine the overturning speed of a vehicle travelling around a 30 metre radius curve. This indicated an overturning speed of 49 km/h (30 mph), comparable with the results of the simulation.

113 The overturning mechanism would not have been prevented by a check rail or *grooved rail*. These rails limit the extent to which a wheel can move sideways away from the adjacent rail. Check rails are fitted on some tight curves on conventional track. Grooved rail is normally used when tramways are laid in roads and can be used at other locations (figure 21). Neither of these would have prevented the left-hand wheels of tram 2551 lifting upwards, and neither would have prevented the right-hand wheel flanges riding up onto the adjacent rail head.

The tram's behaviour after leaving the track

114 The tram's path, from the point at which it left the track (the end of the dynamic simulation by Bombardier Transportation, paragraph 102) to its final resting place, was reconstructed by the RAIB based on marks and damage observed on site (figure 22) and on the tram itself.

¹⁰ The actual critical speed may differ slightly due to variables such as whether passengers move as the tram begins to derail. For example, if every passenger moved one step (or a similar distance if seated) towards the right side of the tram in order to steady themselves, the critical speed would reduce by about 1.5 km/h.

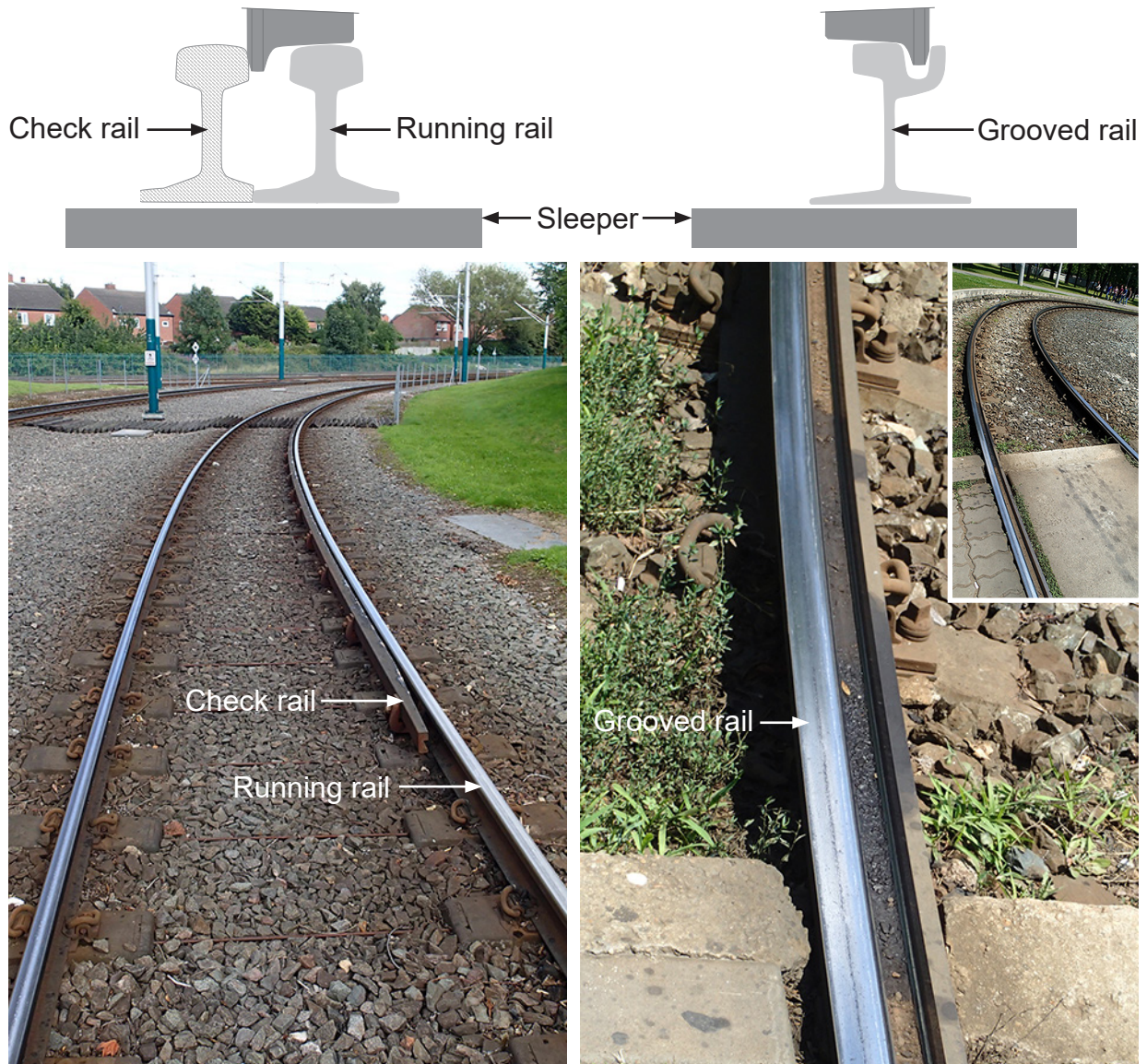

Figure 21: Example of check rail and grooved rails (not photographed on the Croydon tramway)

115 The tram's path comprised two separate phases: one during which the tram continued to overturn and one during which the overturned tram slid along the ground before coming to rest. An overview of this motion is shown in figure 15 and details are illustrated in figures G.1 onwards (Appendix G). The tram travelled for approximately 18 metres once it had left the track before it fully overturned, and then slid on its side for approximately 9 metres. Overall, these two phases lasted for around three seconds.

116 At the time the tram left the track (figure G.1), the roll induced on the vehicles as a result of the lateral acceleration led to the pantograph striking an OHLE *dropper* and the pantograph becoming detached (figure G.2). The roll also led to the outer lower edge of the trailing vehicle rubbing and breaking concrete walkway slabs on the ground (figure G.3). The tram continued to roll as the tram travelled across the gap between the inbound and outbound lines of the south curve.

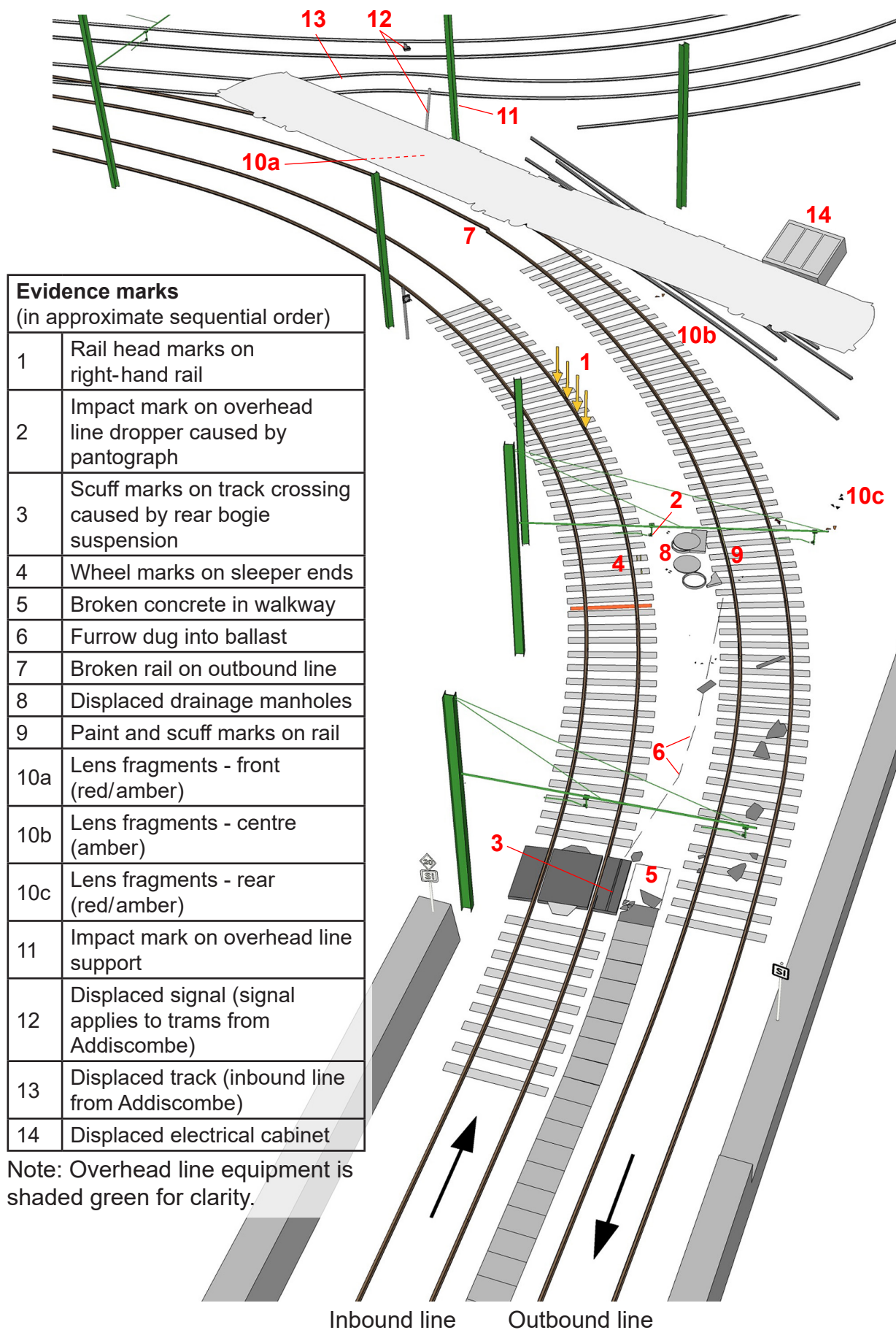

Figure 22: Witness marks used to determine path of tram after leaving the track

- 117 After travelling approximately 10 metres in this gap, the front of the tram struck the nearest rail of the outbound line, breaking the rail at a welded joint (figure G.4). It is likely that striking this rail triggered a relatively rapid overturning motion resulting in the side of the tram hitting the ground (figure G.5).
- 118 Once on its side, the overturned tram slid and collided with an OHLE support mast (figure G.6). As the tram slid against this mast, equipment was knocked off the tram roof and the tram struck the signal controlling tram movements from Addiscombe (signal SNJ 04S), and the track of the inbound Addiscombe line (figure G.7). The tram then struck a cabinet housing electrical equipment (figure G.8) before stopping across the inbound line from Addiscombe and the outbound line to Lloyd Park (figure G.9). These collisions with the infrastructure partially guided the tram's trajectory.

Identification of causal factors

- 119 The tram did not slow down to a safe speed before entering Sandilands south curve because the driver did not apply sufficient braking.**

The tram

- 120 RAIB carried out extensive testing of tram 2551 at its facility in Aldershot. This included testing the TBC, braking system, DSD, windscreen wipers and washers, headlamps and the cab heating and ventilation equipment. A summary of the testing of tram 2551 is provided at Appendix E. No faults relevant to the accident were found, although a minor misalignment of the headlights (Appendix E) and an issue affecting the speedometer after the accident (Appendix H) were noted. Analysis of the traction and braking processors (paragraph 39) showed that there were no faults logged immediately before the tram overturned. LT's maintenance records show that there were no relevant outstanding maintenance or repair issues relating to tram 2551 at the time of the accident.
- 121 OTDR data indicates that the service brake slowed the tram appropriately on the approach to speed limits and other tram stops during the morning of the accident. This supports the conclusion from testing that the brakes were operating normally before the accident.
- 122 Since the RAIB found no evidence of any fault with tram 2551 that could have caused or contributed to the accident, the investigation has sought to understand the factors that resulted in the driver not applying sufficient braking on the approach to Sandilands south curve.

The actions of the driver of tram 2551

- 123 **Although some doubt remains as to the reasons for the driver not applying sufficient braking, the RAIB has concluded that the most likely cause was a temporary loss of awareness of the driving task during a period of low workload, which possibly caused him to microsleep. It is also possible that, when regaining awareness, the driver became confused about his location and direction of travel.**
- 124 When the driver signed on at 04:48 hrs on 9 November 2016 he spoke with two controllers in the control room (paragraph 46). The duty manager also countersigned the driver's entry in the signing on duty book. Nobody who spoke with the driver when he signed on duty raised any concerns about his fitness to work that morning. Before he was taken from the scene of the accident, the British Transport Police tested the driver for the presence of alcohol, cannabis and cocaine. The driver was subsequently tested at a British Transport Police station for common 'over the counter' prescription drugs and for drugs of abuse, such as amphetamines, opiates, LSD, PCP and cannabinoids. No traces of alcohol, drugs of abuse or medication likely to affect performance were found during these tests.
- 125 Post-accident medical assessments of the driver were undertaken for the RAIB by a doctor experienced in carrying out medical examinations of pilots involved in incidents and accidents, and by a consultant neurologist. The initial examination included testing for diabetes, anaemia and the functioning of the kidneys, liver and thyroid gland. No issues relevant to the accident were identified. The driver's eyesight was also examined and was found to be normal. The examinations included a brain scan and an EEG (electroencephalogram). These medical examinations did not identify any medical conditions (for example, seizures or blackouts) that could have caused the accident.
- 126 Evidence indicates that the driver had been assessed as competent (paragraph 42). He was very familiar with the route and with the tram (paragraphs 42 and 43). He had no record of driving at excessive speed, had no known relevant medical conditions and was regarded by TOL as reliable and compliant with the rules.
- 127 The driver stated that, in the months before the accident, he had not been affected by any significant personal or work related events which could have distracted him at the time of the accident. There is no witness evidence and no evidence from tram testing that external events or the cab environment affected the driver's actions. Post-accident testing demonstrated that the windscreen wipers, windscreen washers, ventilation system, seat position and in-cab lighting were operating correctly. There is no evidence of the driver using a mobile phone or radio at the time of the accident.
- 128 The driver stated that he normally applied the tram's brakes on passing the second tunnel gap when approaching Sandilands junction from Lloyd Park. This gap is located around 263 metres after entering the first tunnel, around 250 metres from the end of the tunnels and about 340 metres from the 20 km/h speed sign (figure 6). This braking point was also normally used by 49% (29 out of 59) of tram drivers responding to the RAIB's driver questionnaire (paragraph 91).

- 129 Information from the OTDR (figure 23) showed that when the tram passed the second tunnel gap, the TBC was in the drive position with the tram travelling at 79 km/h (49 mph). The TBC remained in drive for a further eight seconds. By then the tram was about 155 metres beyond the driver's normal braking point. At this point, about 185 metres from the 20 km/h speed sign, the driver then made a brief brake application of less than one second (paragraph 51). The driver stated that he realised that he had become disorientated at about the time that the tram passed the second tunnel gap. Although he cannot recall making this brake application, he believes that it may have been when he was reorienting himself (paragraph 153).
- 130 The driver's application of the service brake after exiting the Sandilands end of the tunnels took place about 57 metres, about three seconds, before reaching the 20 km/h speed sign at the start of the Sandilands south curve (figure 23). The driver was not able to recall why he had applied the brakes at this point but stated that this brake application was not because he now realised the tram was approaching the curve at Sandilands junction.
- 131 The OTDR does not record the level of service brake applied in the last 57 metres before reaching the 20 km/h speed sign. However, the tram's speed only reduced by 5 km/h over this distance (paragraph 52 and 53). Deceleration rates are determined by a combination of the amount of brake applied and the adhesion available at the wheel-rail interface. The exact effect of using alternative braking scenarios on the day of the accident cannot be determined with confidence because the wet condition of the rails at the time of the accident (paragraph 108) means it is possible that the available adhesion would have extended the braking distances given in table 1 (paragraph 32).
- 132 From the values shown in table 1, it can be concluded that even had the rail head been dry it is almost certain that the application of full service braking at a distance of 57 metres from the 20 km/h speed sign would not have slowed the tram to a speed below that necessary to cause overturning. However, calculations suggest it is possible that application of the hazard brake would have slowed the tram to a speed below that necessary to cause overturning.
- 133 The driver's actions from leaving Therapia Lane (paragraph 48) until completing the right-hand turn after Lloyd Park tram stop and beginning the tram's acceleration to 80 km/h (50 mph) showed no evidence of unusual behaviour. The RAIB therefore concludes that the driver first lost awareness of the driving task at some point after completing the right turn and before reaching his normal braking point at the second tunnel gap. It is not known with certainty when he regained awareness of the driving task.
- 134 The possibility that the 'strobing effect' as the tram moved past the tunnel lights caused the driver to suffer a medical condition, such as a seizure, has been discounted as a possible factor. Research commissioned by the RAIB identified that the *flicker rate* of the tunnel lights was between around 0.62 Hz and 1.74 Hz (flashes per second).

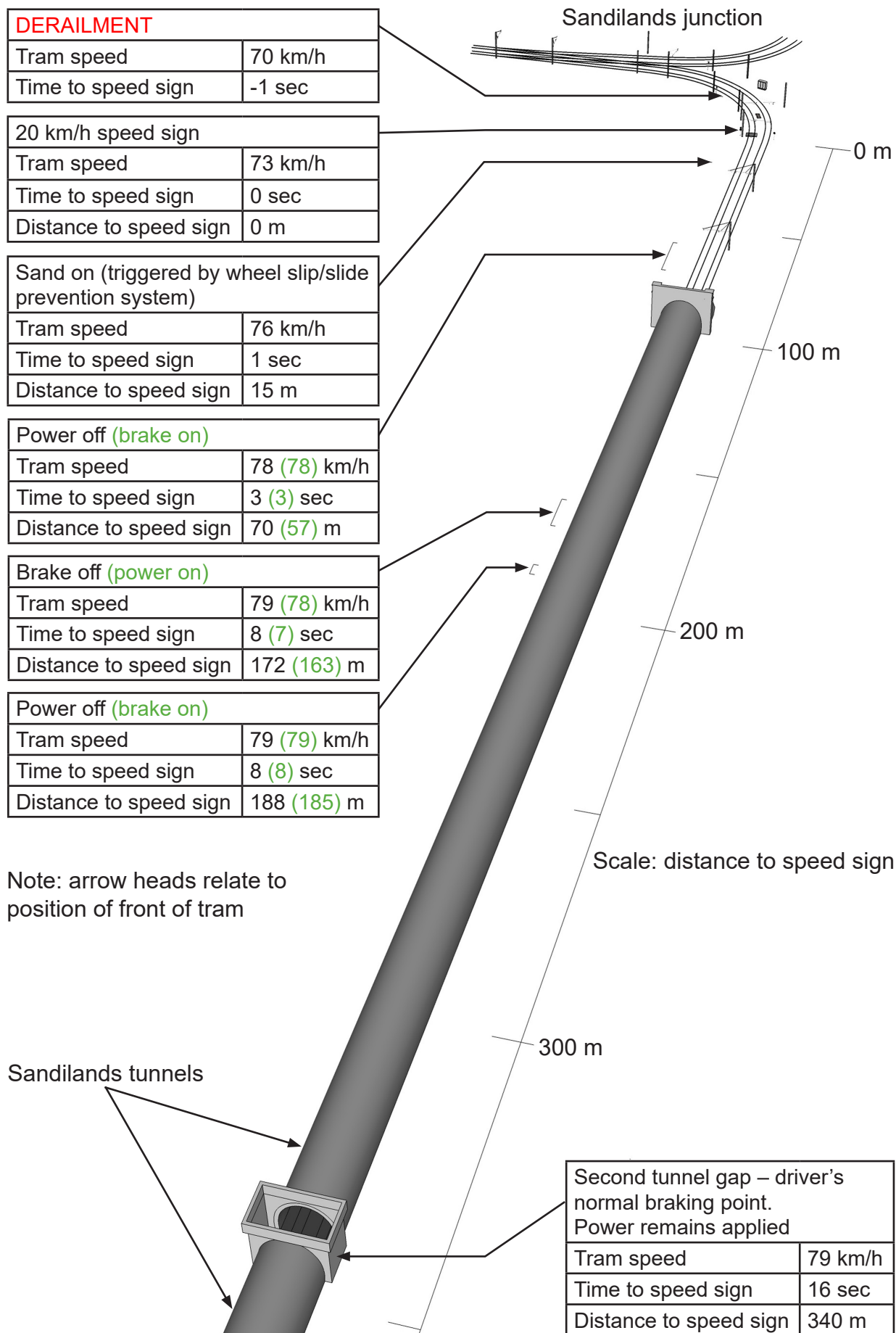

Figure 23: Information recorded by the OTDR as tram approached accident site

135 The frequency band for photosensitive epilepsy is between 3 Hz and 30 Hz¹¹, although this varies from person to person. The flicker rate of the tunnel lights was therefore lower than the normal trigger range for photosensitive epilepsy. Whilst people can be affected by flicker rates below 3 Hz, the driver had no previous history of any photosensitive episodes and had driven through the tunnel thousands of times without experiencing any such problems.

Factors influencing the driver's actions

136 The RAIB has identified a number of factors that may have influenced the driver's actions:

- i. low driver workload when approaching the accident site (paragraphs 138 to 142);
- ii. although there is no evidence that the driver's shift pattern carried an exceptional risk of causing fatigue, it is possible that the driver had become fatigued due to insufficient sleep when working very early turns of duty (paragraphs 143 to 152);
- iii. possible disorientation of the driver (paragraph 153 to 156); and
- iv. the infrastructure approaching the curve did not contain sufficiently distinctive features to alert drivers to their position relative to the curve at Sandilands or to their direction of travel in the tunnel (paragraphs 157 to 176).

137 The RAIB has also considered whether an undetected medical condition contributed to the driver's performance. Although no evidence has been found, it cannot be entirely discounted (paragraphs 177 and 179).

Workload

138 The driver lost awareness of the driving task during a period of relatively low workload, a situation which can result in a state of mental 'underload' in which the driver's attention to the driving task is diminished due to a lack of stimulation. It is probable that underload led to the driver losing awareness of the driving task on the day of the accident. Underload can affect performance on its own, or it can trigger a microsleep in the absence of fatigue, or it can interact with fatigue to exacerbate the effects on performance.

139 Because of the limitations in the way the OTDR records data (paragraph 38), it is uncertain exactly how the tram's speed was controlled as it accelerated from the curve beyond Lloyd Park until the brief brake application about 155 metres beyond the driver's normal braking point.

140 The driver stated that, after accelerating from Lloyd Park, he would normally select coast on the TBC once the tram reached a speed he was comfortable with and that this was around the entrance to the first tunnel¹². OTDR data indicates that, on the day of the accident, the tram accelerated throughout the approach to the tunnels and that the TBC was kept in either the drive or cruise position once the tram's speed reached 80 km/h (50 mph) (the OTDR does not differentiate between the drive or cruise positions). The tram's speed stabilised at 79 km/h (49 mph) and stayed at this speed as the tram entered and travelled through the tunnel, still with the TBC recorded as being in either the drive or cruise position.

¹¹ www.epilepsysociety.org.uk.

¹² Travelling in this direction the track slopes gently downwards through the tunnels to Sandilands south curve.

- 141 It is possible that, on this occasion, the driver used the cruise setting on the TBC to maintain speed, instead of the coast position he normally used. He may also have manually controlled the tram's speed by making adjustments to the TBC while it was in the drive position. The RAIB has concluded that it is more likely that the driver used the cruise position, as this is positioned close to where the coast position starts on the TBC (figure 13) and making manual adjustments within the drive position would have been a significant departure from his normal practice. Controlling the tram's speed during the 49 seconds between accelerating the tram after the right-hand curve leaving Lloyd Park, and reaching his normal braking point at the second tunnel gap, did not require a large amount of concentration or actions from the tram driver, particularly as the tram's cruise control system was probably managing its speed from a point near the entrance to the first tunnel.
- 142 An analysis of driver workload undertaken by the RAIB determined that several sections of the tram network present a relatively low level of driving workload. Most of these sections are on the off-street part of the network and the Lloyd Park to Sandilands section presents the longest duration of continuous driving with minimal active control required by the driver. While there are other long sections between tram stops, they involve slower speeds with more control actions which demand higher levels of attention from drivers. Apart from the public road crossings and the curve coming out of Lloyd Park, the section of line from Lloyd Park to Sandilands is long and fast, and demands a low level of driver attention. In the RAIB questionnaire (paragraph 91), this section (along with some other off-street sections) was rated as significantly lower in terms of perceived attention demand than street running sections. Only the short section between Arena and the Elmers End terminus was rated lower than the Lloyd Park to Sandilands section.

Fatigue (shift pattern)

- 143 An individual can be affected by fatigue if their sleep quality or quantity is disrupted. This may be caused by rosters containing inappropriate working hours, inappropriate overtime/rest day working, and/or by events and actions outside work. There is no evidence that the driver's shift pattern carried an exceptional risk of fatigue (paragraphs 144 to 146). However, some unrelated improvements to TOL's rosters are possible (paragraph 367).
- 144 The driver was on a roster of permanent early shifts. Whilst early shifts are a risk factor for fatigue, due to the reduced opportunity for sleep, there was nothing exceptional about the driver's shift on 9 November 2016 compared to his usual shift pattern. The accident occurred on his third consecutive day of work; the previous two days he had worked from 04:50 hrs to 12:59 hrs. Before that the driver had two days off. Table 7 shows the shifts worked by the driver in the three weeks leading up to the day of the accident.

Date	Shift start	Shift end	Duty hours
9 November	04:53	Day of accident	
8 November	04:50	12:59	8:09
7 November	04:50	12:59	8:09
6 November	Rest day		
5 November	Booked holiday		
4 November	04:27	12:06	7:39
3 November	06:17	14:30	8:13
2 November	Rest day		
1 November	Rest day		
31 October	04:38	12:29	7:51
30 October	06:16	13:31	7:15
29 October	04:50	12:51	8:01
28 October	04:38	12:29	7:51
27 October	04:38	12:29	7:51
26 October	04:00	13:00	9:00
25 October	05:05	12:29	7:24
24 October	Rest day		
23 October	Rest day		
22 October	Rest day		
21 October	Rest day		

Table 7: Shifts worked by the driver of tram 2551

- 145 The last time the driver worked a relatively long block of shifts was a seven-day continuous spell that ended on 31 October 2016. This was followed by two rest days, two early starts at 06:17 hrs and 04:27 hrs, followed by another two days not working. The driver next worked on 7 and 8 November 2016, starting at 04:50 hrs and finishing at 12:59 hrs on both days. This gave the driver 15 hours 54 minutes off duty before he booked on at 04:53 hrs on the morning of the accident. RAIB has concluded that the driver's rostered hours should not have caused an increased risk of fatigue on the morning of the accident over and above his typical shift pattern.
- 146 The driver lived about 15 minutes' drive from the depot. The accident occurred 1 hour 14 minutes into the driver's shift, and 14 minutes into the journey from New Addington where the driver had a break from driving of about 6 minutes. There is therefore no evidence that the driver was fatigued because he had been driving (either a car or tram) for a long time without a break.

Fatigue (sleep habits)

- 147 The RAIB examined the driver's sleep habits to understand if these could have been a source of fatigue. The night before the accident he reported that he had gone to bed between 21:30 hrs and 22:00 hrs, slept well and was awoken by his mobile phone's alarm at around 03:30 hrs. This waking time is broadly consistent with a technical examination of the driver's mobile phone arranged by the BTP which showed that the phone's alarm operated at 03:20 hrs. The driver stated that on the two previous nights, 6 and 7 November 2016, he had followed a similar sleeping pattern and that this reflected his normal habit when starting work at around 05:00 hrs.
- 148 The technical examination of the driver's mobile phone also showed that, at about 23:00 hrs on the night before the accident, a work-related document was downloaded in a process which was not automated and required manual operation of the phone (the download is recorded at 22:59:56 hrs on 8 November 2016). The driver stated that he could not recall downloading the document, but there is no evidence suggesting that someone else did so. For this reason, it is not known whether, on this night, the driver remained awake until 23:00 hrs, or woke in the night and checked his mobile phone. Since manual operation of the mobile phone was required to download the document, it is possible that the driver had less than his reported normal five and a half to six hours sleep on the night before the accident. He has stated that he felt fine on the day of the accident and that, when starting work on that day, he felt normally rested.
- 149 The driver's reported normal pattern of five and a half to six hours sleep before starting work at around 05:00 hrs is less than the seven to eight hours of sleep that most people need each night¹³. However, the driver stated that this sleep pattern did not result in sleep deprivation. He stated that he normally fell asleep fairly easily when going to bed, woke easily in the morning, and generally slept well. There are individual differences in sleep requirements, and it is possible that the driver was one of the people who needed less than the average amount of sleep. Alternatively, it is possible that his reported normal sleeping pattern of five and a half to six hours sleep when starting work at around 05:00 hrs resulted in him incurring a sleep debt, the situation which occurs if people have less than the required amount of sleep. Downloading a document at about 23:00 hrs could have resulted in the driver having less than his usual amount of sleep, and this would have increased the likelihood of a sleep debt. A sleep debt can only be repaid by having more sleep.
- 150 Some evidence that the driver's reported normal sleeping pattern may have incurred a sleep debt is given by his statements that he normally fell asleep fairly easily, occasionally slept in the afternoon (which he found refreshing) and that on rest days he would choose to wake naturally rather than using an alarm, when he would sleep for longer until other family members awoke. Although recognised by fatigue specialists as indications that a person is possibly not getting enough sleep, these were not among the fatigue indicators included in ORR and RSSB fatigue guidance, and were not briefed to the driver by TOL (briefings in parts of the rail industry are discussed at paragraph 363). There is no evidence that the driver was aware of these fatigue indicators.

¹³ 'Fatigue – a good practice guide' 2012. Available at www.rssb.co.uk.

- 151 When people have a sleep debt they can experience deteriorations in performance and alertness. One manifestation of this is a propensity to fall asleep briefly during waking hours, even when driving. These are known as microsleeps and are unintentional periods of sleep lasting anywhere from a fraction of a second to a few minutes. They are often, but not always, characterised by closing of eyes or head nodding actions. People often do not remember having a microsleep.
- 152 Low workload and a lack of associated stimulation (paragraph 138) can increase the likelihood of a fatigued person microsleeping. It is therefore possible that a microsleep was a factor in the driver's loss of awareness on the morning of the accident. The RAIB has reached this conclusion based on both the fatigue indicators described above and the absence of any other explanation for the driver losing awareness in circumstances he had managed routinely for around eight years. It is less likely that a microsleep would have happened in a situation where the driver had a relatively high workload. A microsleep might not result in the tram being stopped by the DSD for reasons explained at paragraph 402.

Disorientation

- 153 Following the accident, at 06:50 hrs, the driver told a British Transport Police officer that he believed he had become disorientated and thought he was heading towards Lloyd Park. The distress associated with the accident means that the driver may have been offering his best attempt at explaining his actions, rather than a true memory of events.
- 154 The driver stated that he could not recall anything unusual about the journey from Lloyd Park until he realised that he had become disorientated at some point after entering the Sandilands tunnels. The driver stated that he was then initially confused about the direction in which the tram was heading but concluded that it was heading towards Lloyd Park (ie he incorrectly believed that he was travelling away from Sandilands junction). He stated that he did not realise he was approaching Sandilands until the tram turned into the curve.
- 155 In psychological terms, after beginning to regain his awareness, the driver would have had to reconstruct a mental picture based partly on his recent memory (which had been disrupted due to the loss of awareness episode) and partly on external information cues in the environment. Neither of these was strong enough to prompt the driver that he was in fact heading towards Sandilands south curve. It is also possible that his ability to reconstruct this mental picture may have been affected by a residual decrease in attention associated with the loss of awareness episode.
- 156 It is uncertain when the driver began to regain awareness of the driving task, although it is possible that he did so about eight seconds (155 metres) after the second tunnel gap when he made a brief brake application (paragraph 129). It is therefore uncertain when he started to become aware of the external cues, uncertain which (if any) external cues influenced his initial reconstruction of his mental picture and uncertain which (if any) cues were seen subsequently.

Cues to normal braking points in the tunnel

- 157 The tunnels did not contain distinctive features which would alert drivers during darkness to normal braking points (such as the second gap used by the driver of tram 2551). In the accident context, and depending on the exact nature of the driver's disorientation, it is possible that had such feature(s) been present, they could have increased the driver's awareness at an earlier time and/or helped him reconstruct an appropriate mental model including the correct direction of travel.
- 158 Both the first and second tunnel gaps are around six metres long. A tram travelling at 80 km/h (covering 22 metres each second), the maximum permitted speed through the tunnels and the approximate speed of tram 2551 on the day of the accident, will pass through each gap in about 0.3 seconds. The gaps are not clearly distinguishable at night because they are not clearly illuminated by the tunnel lighting and the light spacing does not change significantly in the vicinity of them. During the hours of darkness the three parts of Sandilands tunnels appear to a tram driver as a continuous tunnel, except for an increase in illumination at each end. The only visual indication of the gaps in the dark are short lengths of white fencing on the left-hand side of the tracks at each gap. The gaps are clearly apparent during daytime due to daylight filtering through them.
- 159 Some tram drivers said they used a noise as the tram passed over a rail joint near the second gap as a prompt to start braking. The driver of tram 2551 stated he was not aware of such a noise from the track at that location and so was not listening out for it as a cue to start braking.
- 160 Sound level testing commissioned by the RAIB and undertaken by TRL included an assessment of sound levels recorded in the driving cab of a tram as it transited the tunnel. There were no discernible changes in sound levels measured as the tram passed the tunnel gaps. Therefore, the sound levels do not provide a reliable cue that the tram is passing a gap in the tunnels.
- 161 Recognition of the tunnel gaps would only be a reliable cue to the need for a brake application for Sandilands south curve if the two gaps could be distinguished. There are no distinct visual features to differentiate between the first and second gaps in daytime or in darkness, although in daylight with clear weather conditions, the tram line from Addiscombe can be seen more clearly from the second tunnel gap, providing a cue as to which direction the tram is travelling. It is possible that a distinctive feature at, or near, the second tunnel gap would have alerted the driver of tram 2551 to his position and thus the need to apply the tram brakes.
- 162 The difficulty in differentiating between the two gaps has resulted in at least one other driver becoming confused and believing that they were passing the first gap when they were actually at the second gap. This led to a serious overspeed incident on 31 October 2016 (paragraph 180).
- 163 RAIB's driver questionnaire found that, of the 59 drivers responding, 21 reported missing their normal braking point in Sandilands tunnel¹⁴. Of these, nine drivers said they had used the hazard brake to reduce the tram's speed to negotiate the curve. It is not known when these events occurred or if they occurred during daylight or darkness. These incidents are considered further at paragraphs 227 to 229.

¹⁴ Possible influences on questionnaire responses are described at paragraph 91.

164 The gradient of 1:118 (0.8%) falling towards Sandilands throughout the tunnels provides a weak visual cue to the direction in which a tram is travelling. The difference between rising and falling gradients can affect a driver's choice of TBC control settings but, in the context of the Sandilands tunnels, the tunnel approaches have a greater effect on this as trams travelling towards Sandilands can reach the maximum permitted speed of 80 km/h (50 mph) before reaching the tunnels. In the opposite direction, the distance from the outbound curve at Sandilands to the tunnels is insufficient for trams to reach this speed. Neither the gradient nor differing TBC settings provide strong cues about a driver's position in the tunnel or their direction of travel.

Cues after the normal braking point used by the driver of tram 2551

165 Several cues concerning location and direction of travel were available to the driver of tram 2551 after the tram passed his normal braking point at the second tunnel gap. They were also available after the tram passed the position where a brief brake application is a possible indicator that the driver had incorrectly concluded that he was heading away from Sandilands (paragraph 153). These cues were not sufficiently strong or distinct enough to re-orientate the driver so that he recognised the need to apply the tram's brakes. If the driver believed he was heading towards Lloyd Park, the cues were insufficient to override this belief.

166 The full length of the tunnels is illuminated day and night with a length of about 58 metres at each end of the tunnel group being more brightly lit than the central portion. All light units are about 1.6 metres long and mounted on the tunnel walls about 3.4 metres above the ground. Light units in the central portion are located on both sides of the tunnel at approximately 25 metre intervals. Light units are very closely spaced in the end sections giving the appearance of a continuous strip of light when illuminated.

167 At the time of the accident, only some light units were illuminated in the end sections and the arrangement of lit lights was different at each end. For 58 metres at the Sandilands end of the tunnels, almost all lights were illuminated on the right-hand side of the tunnel when heading towards Sandilands, while lighting on the left-hand side was limited to the final 14 metres before the exit. Travelling through the final 58 metres at the Lloyd Park end (when heading towards Lloyd Park), almost all lights were illuminated on the left-hand side while almost none were illuminated on the right-hand side (figure 24). TRL considered the lighting in the context of its highway design expertise and reported that the lighting would not have been a strong informational cue concerning direction of travel. Some light units were unlit in the central part of the tunnel. There is no evidence that unlit light units contributed to the accident.

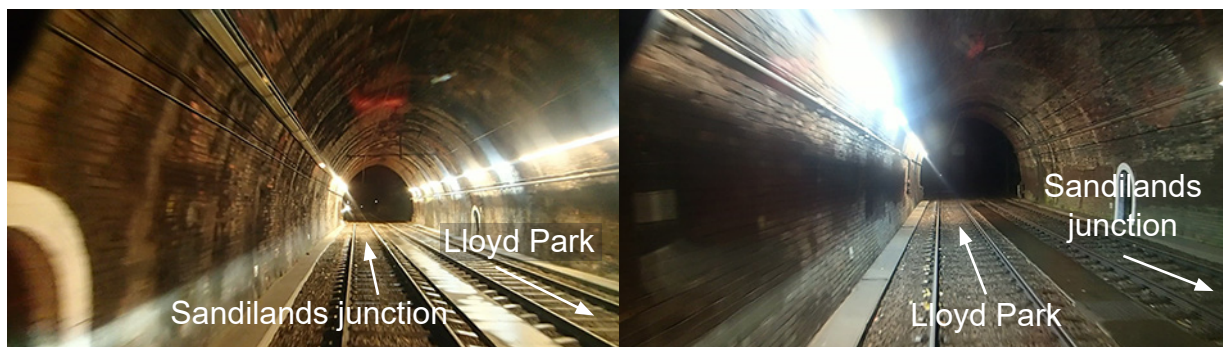

Figure 24: Exiting the tunnels towards Sandilands junction (left image, accident situation) and Lloyd Park (right image)

168 The walkway lights adjacent to the left-hand side of the track on the exit from the tunnel were probably the strongest cue that the tram was exiting the Sandilands junction end of the tunnels. Similar lights are not provided when exiting towards Lloyd Park. The walkway lights start seven metres outside the tunnel mouth and continue at intervals of about five metres for a distance of 70 metres (until about 18 metres from the speed sign at the start of the curve). Testing by the RAIB and TRL showed that, when travelling towards Sandilands, these lights were visible about 250 metres before exiting the tunnel but are not distinguishable from the tunnel lighting until around 80 metres from the tunnel end (figure 25). At a distance of 50 metres from the tunnel exit, about seven seconds before reaching the 20 km/h speed sign, these lights would have been clear and distinct. Tram 2551 passed the last of the walkway lights less than a second before reaching the 20 km/h speed sign. Although it was raining heavily, visual perception of the lights is unlikely to have been affected by the rain.

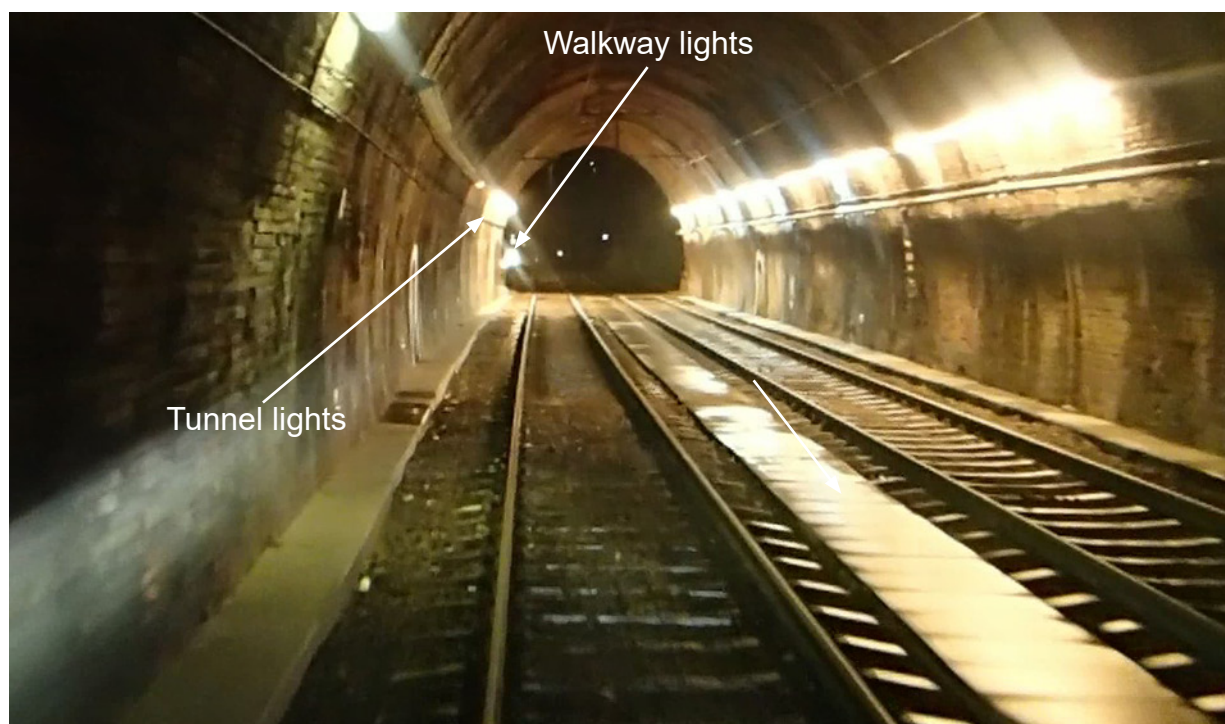

Figure 25: Walkway lights viewed approaching Sandilands west curve, about 80 metres from tunnel exit

169 The 20 km/h speed sign (figure 26), and sighting of the curve itself (figure 10), were both potential cues to the driver that he was approaching Sandilands south curve. If not recognised as being at Sandilands south curve, they provided information about the need to slow the tram rapidly. However, neither of these cues alerted the driver to apply the braking needed to avoid the accident and neither resulted in the driver applying the hazard brake.



Figure 26: 20 km/h speed sign and 'SI' sign at the start of the west curve

170 Post-accident testing found that the 20 km/h speed sign¹⁵ at the bend was readable at night from about 90 metres when the tram's headlamps were set to main beam, and about 60 metres when set to dipped beam. The testing also found that the left-hand curve was first visible at the same time as the speed restriction sign.

171 The testing was carried out in dry conditions, so these distances would have been reduced on the morning of the accident because of the heavy rain. The driver was unable to remember whether he was using main or dipped beam headlamps when approaching Sandilands junction on the day of the accident, but stated that he often used main beam to supplement the tunnel lighting when transiting the tunnel, switching to dipped beam as the tram passed around the curve. The headlamp setting is not recorded by the OTDR so the RAIB has not been able to establish which setting the driver was using as the tram approached the curve.

¹⁵ The tests used a replacement sign similar to that in place at the time of the accident.

- 172 TRL assessed the 20 km/h sign that was in place at the time of the accident and concluded that it did not provide tram drivers with a strong visual cue that a brake application was required. It was too small and poorly reflective, so could not be seen until after the driver needed to apply the brakes in order to comply with the speed restriction. ORR stated that the 20 km/h sign met the minimum dimensions and reflectivity requirements in place at the time the tramway was constructed.
- 173 The 20 km/h tramway sign was not required to meet current visibility standards for other road vehicles on public roads. However, to illustrate the effectiveness of the Sandilands speed sign, TRL compared it with current visibility standards for speed signage applicable to other road vehicles on the public highway. The tests used a CR4000 tram's headlamps on main and on dipped beam at distances of 90 and 60 metres from the speed sign. The luminance (the amount of light reflected from the sign's surface) was less than is required to meet the current 2007 standard^{16 17}.
- 174 In addition to the heavy rain, the following factors may have also reduced the conspicuity of the speed sign and the curve:
- The presence of glare from the walkway lights and darkness beyond these (ie darkness in the unlit junction area).
 - The presence of an SI sign (figure 26) immediately beneath the speed sign which reduced the conspicuity of the speed restriction sign. Testing by TRL found that from 90 metres the speed restriction sign and SI sign reflected about the same amount of light, and that from 60 metres the SI sign reflected more light than the speed restriction sign. This was true of both main and dipped beam headlamp settings.
- 175 Headlamp testing undertaken by TRL on behalf of the RAIB found that the dipped beam on the right-hand side of the tram was directed slightly above (0.7 degrees above) the alignment necessary to pass DVSA MOT test requirements¹⁸. This would have improved illumination ahead, but could have dazzled oncoming drivers. The main beam alignment is not assessed as part of the DVSA MOT test. Therefore, the main beam alignment is specified by the LT maintenance instructions to be near horizontal and centred ahead. When tested, the left-hand side (near-side) main beam was found to be aligned to the left of centre by about 1.7 degrees. This is likely to have improved visibility of the speed sign which was also positioned to the left.
- 176 It is possible that one or both of the headlamp alignment issues was a consequence of accident damage. If present before the accident, neither would have had a detrimental effect on the driver's view of the line or signage ahead.

¹⁶ Research based guidance reported by Padmor P (2002) 'Minimum required night time luminance of retro-reflective traffic signs'.

¹⁷ British and European Standards BE EN12899 – 1:2007 (BSI 2007) specify the optical performance of sign face materials but this applies to new signs only and not to signs that have aged and weathered.

¹⁸ DVSA MOT test requirements as stipulated in the Public Service Vehicle Inspection Manual under Section 67, Aim of Headlights (DVSA, 2013).

Potential undetected medical condition

- 177 Although highly unlikely, an undetected medical reason for the driver's loss of awareness, and disorientation, cannot be discounted. Four passengers on the tram told police officers that the driver had indicated that he had 'blacked out' but there is evidence that this was caused by the accident.
- 178 Although no medical reason for the driver's loss of awareness was found during post-accident medical examinations (paragraph 125), the driver recalled a previous occasion when he had become disorientated. Around two years before the accident at Sandilands, when driving between Arena and Woodside tram stops, he stated that he momentarily lost his awareness of the tram's heading but was able to re-orientate himself when he saw the lights of Woodside tram stop in the distance. He had not mentioned this to anyone because he thought it was a normal effect of driving a tram in the dark and he had not experienced such issues when driving on the road. The RAIB notes that the section of route between Arena and Woodside tram stops is also one that imposes a low level of driver workload.
- 179 Similar to fatigue and a loss of awareness due to task underload, a momentary loss of attention due to a medical condition (eg a neurological episode) would not result in the tram being stopped by the DSD if the required force to hold the TBC down is maintained.

Consideration of other factors

TOL's response to an speeding incident at Sandilands on 31 October 2016

- 180 An incident on 31 October 2016 involved a driver using his tram's hazard brake to avoid travelling around Sandilands south curve at a speed likely to have resulted in the tram overturning. The tram traversed the curve at a speed that forced passengers towards the right-hand side of the tram. Loop data from the tram control system (paragraph 18) indicated that the tram entered the curve at a speed probably in excess of 45 km/h (28 mph) (the loop data gives a likely speed range of 45 km/h (28 mph) to 91 km/h (57 mph) but the upper part of this range is implausible due to the overspeed protection system fitted to the tram, paragraph 29). Witness evidence shows that the tram brakes were being applied at this time and other conditions (eg passenger loading and rail-wheel adhesion) may have differed from the day of the accident. These circumstances mean that the accident analysis showing that a tram would overturn when travelling at a steady speed of 50 km/h (table 6) is not directly applicable to events on 31 October 2016. Despite these differences, the accident analysis and loop data is sufficient to show that the tram speed on 31 October 2016 was close to the speed at which the tram would have overturned. Although the tram did not overturn, this incident revealed the potential for a driver's mistake to cause speeding and then overturning.
- 181 The incident occurred at around 05:22 hrs when tram 2549 passed around the curve. The driver of this tram stated that he normally applied his tram's service brakes at the second tunnel gap but, on this occasion, missed this braking point and applied the hazard brake when he saw a bank of fog at the exit of Sandilands tunnel. The incident happened in darkness and the driver was intending to follow his normal practice of identifying the tunnel gaps using the short white fences at these locations. On the morning of 31 October he missed the first fence, and so thought the second fence was actually the first fence.

182 The driver did not report the incident (paragraph 189), but later that day, at 20:25 hrs, a passenger used TfL's website to report the incident. This information was automatically forwarded to TOL and was not reviewed by TfL staff. The passenger reported that she had boarded a tram at New Addington at 05:15 hrs and had suffered injuries to her head, shoulder, wrist and finger in addition to being shocked by an incident she described as follows:

'As the tram went around the bend at the junction between Lloyd Park and Sandilands the driver, from my point of view, missed the bend or he was going too fast . . . I was pitched to the corner of the tram and the man sitting on the other side came over on my side and [pinned] me to the corner of the tram'.

183 The limited data storage capacity of the OTDR means that the OTDR data from tram 2549 which related to the incident would almost certainly have been overwritten by the time the passenger made her complaint. Evidence of tram speed at this location would probably have been available from loop data (paragraph 18), but is not available for many locations and TOL's investigation focused on obtaining CCTV images. These can show how tram speed affects passengers in the tram and can allow tram speed to be estimated.

184 TOL processes recognise that CCTV images can assist investigation of this type of report. The processes also recognise that requests for CCTV images must be made relatively quickly because, as stated in TOL procedure OP 0045 'CCTV/audio recording – control and management of equipment', CCTV images on CR4000 trams are overwritten after 72 hours. This is reflected in TOL procedure RP 0021, 'Customer communications' which details actions to be taken in response to customer complaints and states:

'The nature of the complaint may make it necessary for CCTV to be reviewed, the control room must be contacted immediately to request that the relevant CCTV be saved. This is particularly important where on tram CCTV is required because of the limited time span available for saving any recording'.

185 In order to obtain CCTV images, a request has to be made through TOL's controllers, who manage the downloading of tram CCTV images. When a non-urgent request has been made, the tram CCTV is normally downloaded overnight while the trams are in the depot. If an urgent request is made, a tram can be taken out of service and returned to the depot to have its CCTV system downloaded at any time.

186 The member of staff at TOL who dealt with this complaint saw the passenger's email the day after it was sent, although they were unsure at what time they read it. Details of the complaint were entered onto a database of customer complaints and two possible trams were identified as being most likely to have been involved. The following day, at 14:17 hrs on 2 November 2016, the member of TOL staff dealing with the passenger's complaint sent an email back to the passenger asking her to provide additional information allowing the incident tram to be identified. The passenger responded at 20:47 hrs on the same day.

- 187 On 3 November 2016, three days after the incident, the person dealing with the passenger's complaint identified the tram and its driver. The person did this using the information sent in by the passenger and by reviewing the recordings of CCTV at New Addington tram stop. No further action was taken at this point because the potentially serious nature of the incident was not understood. The CCTV images of the incident recorded on the tram were lost during this day as they were overwritten by more recent images.
- 188 The following day, 4 November 2016 and four days after the incident, the person dealing with the passenger's complaint requested that the CCTV from tram 2549 be downloaded. This was attempted overnight on the 4/5 November 2016 when it was found that footage from 31 October 2016 had been overwritten and was no longer available.
- 189 TOL's procedures require its drivers to report use of the tram's hazard brake and TOL sent a letter to all its tram drivers in September 2013 reminding them that this is required. The driver of the tram knew that he should have reported the incident on 31 October 2016 to TOL control, but he chose not to. The driver stated that he did not do so because his check of passenger welfare found that they all seemed unharmed and because he had released the hazard brake before the tram came to a stop (often known as a 'partial' hazard brake application). The driver also stated that he had thought that if he reported the incident TOL would have removed him from tram driving while the incident was investigated, and that he believed that some controllers had a belittling attitude towards drivers. TOL's management of tram drivers is discussed further at paragraph 232.
- 190 TOL did not speak with the driver of tram 2549 about the incident until 10 November, the day after the accident at Sandilands. TOL stated that, even if it had spoken with the driver of tram 2549 in the days following his incident on 31 October 2016, it is unlikely it would have taken any action relating to other drivers. In response to being asked whether other drivers would have been briefed about the incident, TOL told the RAIB that:
- 'As this incident involved an allegation of speeding it is unlikely that we would have conducted a specific briefing. It is not necessary to conduct a briefing every time a driver is found to have not complied with the permitted speed as compliance to permitted speeds forms part of the training and ongoing monitoring'.*
- 191 Even had full details of the incident been known to TOL's managers, the RAIB considers it unlikely that they would have recognised the need for urgent implementation of additional measures to mitigate the risk. This is because they neither knew how close the tram came to overturning nor fully understood the actual level of risk associated with overspeeding on curves (TOL's understanding of the risk inherent in the operation of the tramway is discussed at paragraph 195).

The curve at Sandilands junction

- 192 The tight curve on which the accident happened joined the alignment of the former Woodside and South Croydon Joint Railway with the new tramway running parallel with Addiscombe Road towards Croydon town centre (figure 6). Trams from New Addington travel northwards along this former alignment until close to Sandilands junction where they turn westward into the junction and then continue westwards through Sandilands tram stop and onto Addiscombe Road. Trams from Beckenham and Elmers End travel south along the former alignment until just before Sandilands junction, where they then turn westward to the junction, tram stop and Addiscombe Road.
- 193 The amount of land required for tramway construction in part depended on the radii of the curves linking the former alignment with the junction, with smaller radius curves requiring less land (figure 27). As the area was occupied by houses and gardens, there was a desire among designers, residents and others for the amount of land acquisition to be minimised. For this reason, relatively tight curves of approximately 30 metre radius were adopted and legal authority to acquire land was limited to the area needed for these relatively tight curves.

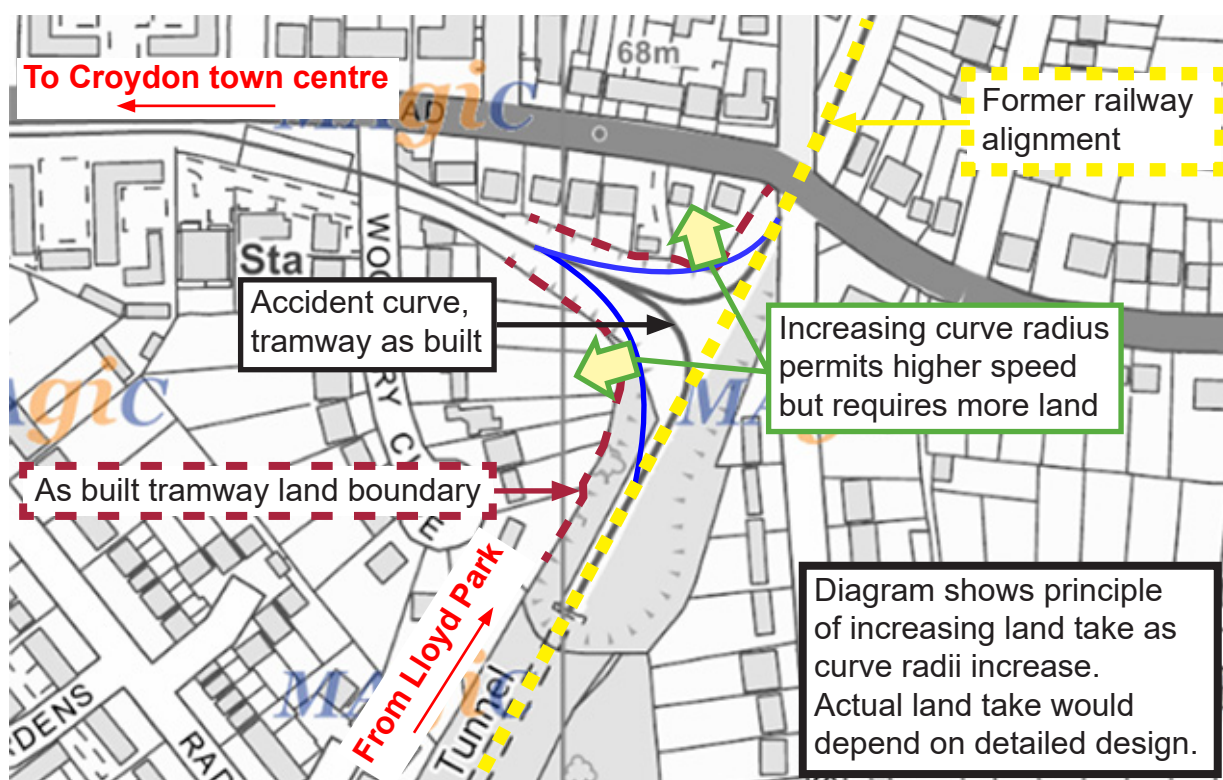

Figure 27: Land required at Sandilands junction (courtesy of magic.gov.uk)

- 194 The installation of tight radius curves is normal on tramway systems in the UK and elsewhere in the world and can be essential to fit a tramway into an urban area. However, such curves, particularly those located after long stretches of high speed running, introduce a risk that overspeeding can result in derailment and overturning. This is a risk that needs to be recognised, assessed and adequately mitigated.

Identification of underlying factors

Hazard identification

195 LT and TOL did not recognise the actual level of risk associated with overspeeding on a curve.

196 This underlying factor arose for the following reasons:

- a. *Route hazard assessments* did not identify the need for additional mitigation due to the risk associated with overspeeding at Sandilands south curve (paragraphs 197 to 201).
- b. *Risk profiling* for the Croydon network did not recognise the level of risk associated with a tram overturning (paragraphs 203 to 211).
- c. Route hazard assessments and risk profiling relied on driver performance as the main means of mitigating the risk of overspeeding (paragraphs 202 and 212 to 214).
- d. Route hazard assessments and risk profiling did not take account of evidence from other tram, road and rail systems showing the level of risk associated with tram overturning (paragraphs 215 to 221).

Route hazard assessments

197 Route hazard assessments form part of TOL's safety management system (SMS) described in its document SM 0100 'Operator's safety management system'. The route hazard assessments were completed for all the tram routes in 2005 at the request of TOL's operations manager. Before then, no route hazard assessments had been completed because TOL had not identified a need to do them.

198 The route hazard assessment that included the inbound line on Sandilands south curve covered the route from Sandilands to New Addington in both directions and was in two parts. Part A was concerned with the general identification of hazards and their consequences. Part B was a detailed assessment of each hazard, a review of the level of risk based on existing control measures, and the identification of any necessary additional control measures required to further reduce the level of risk.

199 The assessments identified three types of hazard: moving (concerned with the control of a moving tram); static (concerned with fixed infrastructure such as signals and points); and environmental (concerned with vegetation, weather and rail head conditions).

200 Part A of the route hazard assessment for the inbound line at Sandilands south curve identified excessive speed on approach and a conflicting movement with an opposing tram at Sandilands junction as moving hazards. Static hazards identified were a failure to observe, or misreading of, signal SNJ 07S (paragraph 26); or anticipation that it would be displaying a proceed indication when it was not. The possible consequence of these hazards was not entered in the route hazard assessment, but the same hazards existed at other locations and the consequences had been identified as either a collision or derailment leading to minor or major injuries or fatality. An environmental hazard 'exiting [Sandilands tunnel] into bright sunlight' was also identified, but again no consequence was recorded. However, the same hazard was identified when heading in the opposite direction and the consequence 'reduced sightlines' was recorded.

201 When heading from Sandilands to Lloyd Park the route hazard assessment included the hazard *'80 km/h line speed, reducing to 20 km/h line speed on descending gradient approaching sharp left curve [close to Lloyd Park tram stop] excessive speed on approach'* with the consequence being identified as a derailment. The level of harm from this hazard was not identified. This same hazard existed when approaching Sandilands from Lloyd Park but was not recorded in the route hazard assessment. The author of the route hazard assessment stated that this was most likely an editorial omission, and not a failure to identify that the hazard existed in the other direction. The same person also stated that a tram overturning on a curve as a consequence of excessive speed was not identified in the hazard assessment for this and other curves on the Croydon network because it was not thought possible.

Reliance on tram driver in route hazard assessments

202 Part B of the route hazard assessment looked at the existing, and where necessary following evaluation, additional measures needed to adequately control risk. For curves similar to that at the accident site, existing control measures relating to excessive speed were described as driver training; specifically lesson 23 'Main line signal and points operations', lesson 25 'Stopping distances' and lesson 26 'The system of tram control'. Although existing control measures were identified, the residual risks were not evaluated and no additional control measures were identified. After the accident at Sandilands, TOL stated that it is unlikely that such an evaluation would have identified the need for additional control measures. The route hazard assessment was due for review in 2006 (one year after it was prepared), but there is no evidence it had been reviewed before the accident on 9 November 2016.

Risk profiling

203 A series of risk profiling exercises were commissioned as part of the on-going management assessment of tram operation on the Croydon tramway. The first was commissioned by TOL in 2008, related only to TOL operations and only involved TOL staff. In 2011, output from the 2008 work was extended to include management of the trams and infrastructure. LT staff participated in this work. A further update in 2012, involving TfL/LT and TOL extended the earlier work to take account of the forthcoming introduction of the new Stadler trams¹⁹. The most recent update before the Sandilands accident was in 2015 and commissioned by TfL/LT and TOL. The resulting report describes the intention of the work as including 'all other aspects of the infrastructure and systems maintenance'.

204 The risk profiling exercises utilised workshops attended by senior managers, most with many years' experience of managing and operating the Croydon tramway. Some had been involved with the tramway since before it opened. The risk profiling was assisted by a consultant with experience of working with the UK rail industry, overseas rail industries and the bus and coach industries. The consultant's facilitator at the workshops had rail experience, but only limited bus and coach experience.

¹⁹ Six new Stadler trams entered service on the Croydon tramway in 2012. These trams were used in addition to the CR4000 trams to increase capacity.

- 205 The risk profiling was based on RSSB's safety risk model²⁰ which is used to understand the overall risk level and risk profile of the main line railway. The safety risk model lists 131 hazardous events. It does not identify a train overturning as a specific event but RSSB stated that the hazard 'derailment of a passenger train' includes the *precursor* 'overspeeding' and that a train overturning is included among the consequences. The consultant facilitating the risk profiling exercise followed the guidance on risk assessment contained in the main line railway guidance note GE/GN8561 'Guidance on the preparation of risk assessments within railway safety cases' (withdrawn on 6 December 2008, after the first Croydon tramway risk profiling workshop) and had adapted the document to make it suitable for use on a tramway.
- 206 The input to the 2008 workshop included a document listing 42 hazardous events, one of which (designated HE140) was 'tram overturning'. The consultant stated that, during the workshop, it was decided that 'tram overturning' was a sub-set of 'tram derailed in service'. This was because *'nobody at the 2008 workshop thought a tram overturning was sufficiently different from a tram derailment to be treated as a separate hazardous event'*. None of the participants have provided evidence that tram overturning was subsequently revisited. Although the RAIB cannot discount the possibility that it was mentioned during later workshops, there is no evidence that the hazard of 'tram overturning' was ever the subject of risk assessment.
- 207 The 2015 workshop ranked hazardous events (eg derailments, collisions and fires) based on their estimated average frequency and their consequence expressed as *fatalities and weighted injuries* (FWI). The workshops also identified precursors, which are signposts to potential future harmful events. Typically, precursors are low consequence and seemingly benign events which could have serious outcomes under different circumstances (for example, a track irregularity not causing a derailment has the potential to lead to a derailment).
- 208 In addition to considering events based on risk ranking, explicit consideration was given to events having multiple fatality or catastrophic risk potential, and these events were agreed and an FWI score assessed for each event. 'Tram derailment in service' was one of eight categories identified as having the potential for multiple fatality or catastrophic risk. This led to consideration of previous experience, which suggested that overspeeding could lead to passenger injuries due to excessively high forces on curves, or signals being passed when displaying stop indications. Overspeeding was also seen as a precursor to derailment.
- 209 Output from the 2015 workshop included an estimate that a tram would derail in passenger service once every 18 months. This was mainly based on the operational experience of the tramway at that time which also indicated that the average consequence of a derailment was one minor injury. The workshop output gave the estimated probability of a fatality from a tram derailing in service as one per 100 derailments, equivalent to one fatality every 150 years.

²⁰ Information about the safety risk model is available from RSSB at [https://www.rssb.co.uk/risk-analysis-and-safety-reporting/risk-analysis/safety-risk-model-\(srm\)](https://www.rssb.co.uk/risk-analysis-and-safety-reporting/risk-analysis/safety-risk-model-(srm)).

- 210 The absence of any detailed consideration of consequences beyond those already experienced by the tramway meant that the adequacy of existing mitigations was not fully considered. Although reference to actual operating experience is important, it is also necessary to assess the risk of high consequence events that occur only rarely. Guidance on risk assessment in the railway sector²¹ identifies the need for particular consideration of infrequent multiple fatality events and the need to ensure that the necessary controls are in place. Since such events will often fall outside the experience of any single tramway, it is necessary to imagine the circumstances that could lead to such an event, and to consider experience on other tramways and in other related transport sectors (evidence related to tram overturning is presented in paragraphs 215 to 218).
- 211 Had the various risk assessments carried out between 2008 and 2015 recognised the level of risk associated with a tram overturning, it is likely that the need for additional mitigations, such as improved signage, would have been identified and found to be reasonably practicable to implement.

Reliance on tram driver in risk profiling

- 212 During the risk profiling workshops, 23 precursors were assigned to the hazardous event 'tram derailment in service'. Six of the precursors related to tram drivers. These included: failing to control speed/movement adequately (6.5% of the contribution leading to a derailment), failing to read signals correctly (7%, although this was associated with the signals provided at junctions, and not speed restriction signs for curves), and tram driver attention distracted (5.5% of the contribution leading to a derailment). The top precursors were vandalism (14% of the contribution leading to a derailment) and tram driver unfit for duty (11.5% of the contribution leading to a derailment). This last precursor mainly related to drivers being unfit for duty due to the presence of alcohol or drugs, or being unwell.
- 213 The precursor events associated with a tram derailment in service were deemed to be adequately controlled through the principles of line-of-sight driving and the competence management system covering tram drivers. This system included assessments and medical examinations, random drugs and alcohol screening, and checking for compliance with driving standards, including speed limits. No further mitigation was deemed necessary.
- 214 Tram drivers failing to control speed/movement adequately was the eighth highest precursor across all hazardous events considered in the risk profiling exercise. In addition to contributing to the 'tram derailment in service' events, this precursor contributed to 'incidents occurring to a rail vehicle' and six other categories of events relating to tramway operation. This precursor was judged to result in 12 minor injuries per year. Again, the mitigation relied on the training, assessment and medical condition of the tram drivers.

²¹ As recorded in RSSB 'Guidance on the preparation and use of company risk assessment profiles for transport operators', issue 1, July 2009.

Previous overturning accidents

215 The route hazard assessments and risk profiling did not take account of evidence showing the level of risk associated with tram overturning. Although no second generation trams had overturned in the UK, the risk of overturning was apparent from events on tram systems in other parts of the world (paragraph 216), historic events on UK tramways (paragraph 217), UK bus and coach experience (paragraph 219) and main line rail experience in the UK and overseas (paragraphs 220 and 221).

216 A search by the RAIB has identified five accidents on tramways outside the UK between 1993 and 2014 in which trams have overturned, although not all instances occurred on curves (table 8).

Year	Location	Cause	Consequence
1993	Poznan, Poland	Overspeed on curve due to unexpected routing at points.	5 fatalities, more than 60 injuries
1996	Kamianske, Ukraine	Runaway downhill due to brake failure and subsequent impact with wall	34 fatalities, more than 100 injuries
2011	Rio de Janeiro, Brazil	Derailed on curve (heritage tram)	5 fatalities, at least 27 injuries
2013	Yuen Long, Hong Kong	Overspeed on curve. Mast supporting catenary prevented full overturning of single deck tram.	77 injuries
2014	Dusseldorf, Germany	Derailment at junction	Several injuries

Table 8: Overseas tram overturning accidents

217 An RAIB review of historic accidents on UK tramways identified that a tram had overturned in Glasgow on 30 March 1953 resulting in 56 people being injured. This accident was caused because the tram exceeded the maximum permitted speed through a junction. The review also identified two occasions in 1934 in which trams overturned on curves due to excessive speed. The first of these, in Liverpool on 3 January, resulted in three people being killed and 30 injured when a tram ran away down a hill and then overturned due to excessive speed because the tram driver mishandled the brakes. The second was at Eltham on 25 March. On this occasion four people were injured when a tram approached a curve too fast and overturned after it detached from the vehicle pushing it.

218 All these accidents involved double deck trams of the first generation which carried little equipment at roof level. These trams are unlikely to have the same resistance to overturning as the single deck tram involved in the Sandilands accident. This is because, although they carried less equipment at roof level, they were significantly taller²². Irrespective of these differences, which the RAIB has not attempted to quantify, the historic events demonstrate that overturning is an issue which should be considered when assessing risks associated with tram operation.

²² Lowering tram height reduces the likelihood of overturning, but adding weight at roof level increases the likelihood.

219 Another source of information about overturning accidents is available from UK highway accidents involving coaches and buses. Statistical data for such events reported to the police and involving injury is presented in table 9. Earlier examples include the death of three people on 3 January 2007 when a London to Aberdeen coach overturned on one of the M4/M25 slip roads. The driver of the coach was reported²³ to have been travelling at 55 mph (89 km/h) around a bend on the slip road which had an advisory speed limit of 40 mph (64 km/h). The coach collided with a crash barrier and then overturned. For a coach to overturn it is likely that it would need to collide with a kerb or crash barrier first, whereas trams already have lateral restraint from the wheel flanges contacting the rails.

Year	Number of buses/coaches involved in accidents causing injuries/fatalities	Number of buses/coaches overturning in accidents causing injuries/fatalities
2012	6318	12
2013	5896	6
2014	6103	6
2015	5381	7

Table 9: Bus/coach accidents and overturning events involving injury, excluding mini-buses, in Great Britain (DfT STATS19 data, see footnote 9)

220 Six examples of accidents involving overturning due to excessive speed on the main line rail network between 1969 and 1994 are given in table 10. These include instances when only part of the train overturned and curves within sets of points. The mitigation provided by the rail industry in response to these events is discussed at paragraph 274.

Year	Location	Cause	Actual vs permitted speed (km/h)	Consequence
1969	Morpeth (northbound)	Overturned on curve due to late application of the brake	130 v 80	6 fatalities, 121 injuries
1972	Eltham (Well Hall)	Overturned on curve due to either no or late application of the brake	104 v 32	6 fatalities, 126 injuries
1983	Paddington	Overturned on a <i>crossover</i> due to late application of the brake	104 v 40	3 injuries
1984	Morpeth (southbound)	Overturned on curve due to either no or late application of the brake	137-145 v 80	35 injuries
1993	Maidstone East	Overturned on curve due to either no or late application of the brake	112 v 40	1 injury
1994	Morpeth (southbound)	Overturned on curve due to excessive speed	130 v 80	1 injury

Table 10: UK railway overturning accidents 1969 to 1994

²³ www.bbc.co.uk.

221 There have also been examples of trains overturning on curves due to excessive speed on railways around the world. Some of the recent key accidents are shown in table 11, again including examples where only part of the train overturned.

Year	Location	Cause	Actual vs permitted speed (km/h)	Consequence
2003	Waterfall, Australia	Overturned on curve due to excessive speed (it was believed that the train's driver suffered a heart attack)	117 v 60	7 fatalities, 40 injuries
2005	Amagasaki, Japan	Overturned on curve due to late application of the brake	116 v 70	107 fatalities, 562 injuries (train struck an apartment block)
2010	Glacier Express, Fiesch, Swiss Alps	Last three vehicles overturned due to excess speed as driver accelerated out of curve	56 v 35	1 fatality, 42 injuries
2012	Nykirke, Norway	Test train overturned on curve	135 v 70	4 injuries
2013	Santiago de Compostela, Spain	Overturned on curve due to late application of the brake	179 v 80	78 fatalities, 143 injuries
2013	Bronx, New York, USA	Overturned on curve due to late application of the brake	132 v 48	4 fatalities, 61 injuries
2015	Philadelphia, USA	Overturned on curve due to late application of the brake	164 v 80	8 fatalities, 46 serious injuries

Table 11: Worldwide railway overturning accidents 2003 to 2015

TOL's learning from operational experience

222 TOL management were not aware of previous incidents involving late braking on the approach to Sandilands south curve.

223 Although there is evidence that senior managers recognised the importance of learning from experience and encouraged a reporting culture, there were a number of factors which prevented TOL from gaining a full understanding of the extent of late braking on the approach to curves. This is relevant to the accident because, in at least one instance and probably in some other instances, late braking was a consequence of a driver lacking a distinct cue to reliably identify their normal braking point. Reasons for TOL not gaining a full understanding included:

- a reluctance of some drivers to report their own mistakes (paragraphs 224 to 243); and
- potential safety learning from customer complaints was not being fully exploited (paragraph 248).

Near miss reporting

- 224 Reporting of near misses (ie narrowly avoided accidents or ‘close calls’) provides a means of recognising and addressing accident precursors before an accident occurs. It is particularly valuable as a means of recognising hazards which have not been fully mitigated by the design of systems, or in the development of operating practices and training. Near miss reporting often depends on a member of staff revealing information which could reflect adversely on their own performance or the performance of colleagues. It is therefore important that staff are encouraged to report near misses through the existence of a ‘*just culture*’ in which they believe that the response will, where appropriate, concentrate on the learning opportunity rather than disciplinary action or excessive monitoring of the staff concerned.
- 225 TOL processes require that tram drivers involved in accidents, incidents and near misses report the matter immediately to a line controller. In situations where a driver wants to report an issue that does not require an immediate call to the line controller, or they wish to report something confidentially, this can be done through FirstGroup’s own confidential reporting telephone ‘hot line’. At the time of the accident on 9 November 2016 TOL did not subscribe to CIRAS²⁴, a body that was created in 1996 to manage confidential safety reporting on the UK railway system, but which now includes some other industries (for example, some bus operators).
- 226 Despite TOL not being a subscriber, a Croydon tram driver contacted CIRAS on 4 March 2014 about a concern they had about fatigue arising from TOL’s roster. In response, TOL reported to CIRAS that rosters are only implemented following consultation with trade unions and the completion of an assessment of the roster using the HSE’s fatigue risk index (FRI). On this occasion TOL stated that the FRI assessment had not identified any areas of concern with the 2013 roster.
- 227 Of the 59 drivers responding to the RAIB’s driver questionnaire, 21 reported that they had missed their initial braking point approaching the south curve at Sandilands²⁵. Nine responses indicated that drivers had used the hazard brake to comply with the 20 km/h (12 mph) speed restriction around the curve and other drivers reported the need for heavy braking. None of these incidents had been reported to line controllers.
- 228 Responses to the RAIB’s driver questionnaire indicate that the absence of reporting was a consequence of drivers believing that this would result in unnecessary action (eg excessive monitoring) and/or disciplinary action being taken against them (the driver involved in the overspeeding incident on 31 October 2016 cited similar reasons for not reporting what had happened). Among drivers responding to the questionnaire, 29 out of 59 respondents (49%) felt that self-reporting a driving mistake or irregularity would have this consequence. The term ‘blame’ was mentioned in 10 out of 59 (17%) of tram drivers’ questionnaire responses.

²⁴ www.ciras.org.uk.

²⁵ Possible influences on questionnaire responses are described at paragraph 91.

- 229 Had more drivers felt they were able to self-report irregularities, such as missing braking points and then using the hazard brake or heavy full service braking, it is possible that TOL might have identified the need to investigate the reasons why these events were occurring on the approach to Sandilands south curve and then taken any necessary action, such as briefing all drivers or requesting improvements to the infrastructure.
- 230 TOL has stated that no reports relating to tram drivers were made to FirstGroup's confidential reporting system between 2011 and 2016.
- 231 An independent survey undertaken on behalf of TOL in 2016 (before the Sandilands accident) found that 76% of tram drivers responding agreed with the statement '*I believe TOL is dedicated to safety*'. The response rate among tram drivers and driver trainers was reported to be 91%. While this indicates that TOL employees felt safety is of high importance to TOL, it is not necessarily an indication that employees would self-report, particularly if they believed that their actions were the cause.

Tram driver management

- 232 Each tram driver was part of a group of typically eight or nine managed by a specific line controller. The line controllers are also responsible for the day-to-day management of the tramway and differing shift patterns meant that a particular driver could go some time before seeing their allocated line controller. The line controllers report to the duty managers. A simplified version of TOL's driver management structure is shown at figure 28.

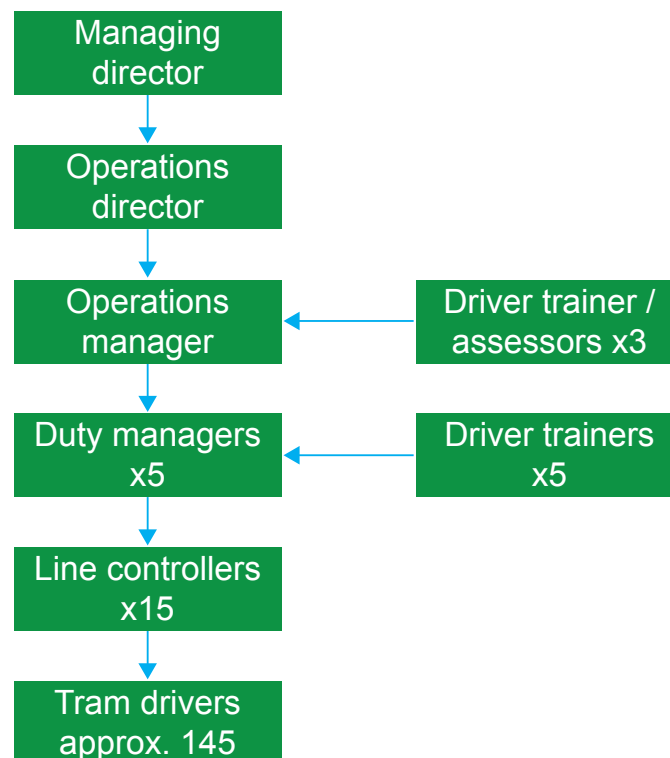

Figure 28: TOL tram driver management structure

233 During 2010, ORR carried out an audit of driver management in all the FirstGroup companies, including TOL. This was done by comparing information gained during the audit with the indicators of good practice that form ORR's railway management maturity model (RM3, now known as the risk management maturity model)²⁶. This describes a number of management elements using a scoring scale of five levels from 'ad hoc' [1] to 'excellence' [5]. ORR concluded that TOL's level of achievement against RM3 was level 3. ORR's audit report included the following statements:

- *'Senior management is highly positive about the importance of safety and is active in promoting and including staff in discussions. There is an open culture around safety at the management level. This is recognised and appreciated by staff.'*
- *'Staff feel that they are encouraged by the company to report issues and that senior management are very open to hearing concerns.'*

234 ORR has stated that the audit found no evidence that TOL was falling below legal standards. However, the audit report did identify the following specific areas to be considered and addressed by TOL:

- *'The review of Driver Management arrangements has found there to be a good culture around safety, competence and incidents at the senior management level though the impression of some drivers is that these good aspects may not always be reflected down the length of the management chain to drivers on a day to day basis'.*
- *'From comments of drivers it appears that there may be some issues with this culture of promoting safety being less prevalent with the first line of driver management which is done by the control staff. The company needs to evaluate the way that controllers and drivers interact'.*
- *'There is some concern that not all issues that are reported by drivers to controllers are seen to be actioned (.....) Drivers may not always be able to be briefed by those they have reported to about the actions, progress and limitations that relate to the issue. This may be leading to an impression that some issues are not being treated properly. This in turn may be discouraging drivers from reporting issues'.*

235 ORR's driver management audit report made several recommendations to TOL, including:

- considering the role of controllers as the first line managers of drivers;
- reviewing TOL's arrangements for staff engagement to ensure that it is obtaining the best involvement from staff to help gather ideas for improvement; and
- improved monitoring of drivers' working hours.

236 TOL reviewed the recommendations and took a number of actions in response. These included the initiation of a regular staff survey to gather ideas to improve staff engagement, a review of the process for checking time sheets for excess hours, and formally recording route hazard assessments (paragraph 197) as part of its SMS.

²⁶ Information about the Risk Management Maturity Model is available at www.orr.gov.uk.

237 With regard to the role of controllers as first line managers of drivers, TOL saw no requirement for change. It recognised that controllers can be perceived as ‘directional’ due to the nature of their role but argued that this was appropriate given that staff had access to senior managers as and when required.

238 ORR told the RAIB that because it had not identified any serious failings with TOL’s management of tram drivers, no follow up action by ORR was deemed necessary.

ORR’s audit of TOL’s safety culture

239 In November and December 2012, ORR conducted a safety culture audit of Croydon tramway staff (TOL, LT and Bombardier, described as ‘Croydon Tramlink’ in ORR’s report) after a tram driver reported a concern that near miss reporting was discouraged. The draft report issued in February 2013 observed:

- *‘The necessary beliefs, attitude, value and behaviour are both visible and repeated in its operations; these being sufficient (sic) embedded to identify the existence of its safety culture.’*
- *‘ORR’s five precursors for safety culture (good practice leadership, attitude towards blame, two-way communication, employee involvement and learning culture steps) are reasonably fulfilled.’*
- *‘It appears a reasonable level of safety culture exists within Croydon Tramlink.’*

240 However, the safety audit identified that some line controllers were more approachable than others, meaning that issues may not be immediately reported by tram drivers. ORR stated:

- *‘Some front line management are considered as being more approachable and/or receptive than others. This means issues may not be immediately reported by staff.’*
- *‘There was no suggestion that issues of immediate safety concern were not being immediately reported. However, staff should have confidence that matters can be brought to any given manager /supervisor and that all managers/ supervisors should be equally approachable and/or receptive.’*
- *‘In this respect managerial approachability of the control room was frequently mentioned in the interviews.’*

241 ORR made several recommendations to Croydon Tramlink following its safety culture inspection in 2012. This included recommendations about:

- putting in place procedures to examine and improve safety culture (the intent of this recommendation was to build on and improve the current safety culture using ORR’s risk management maturity model);
- considering if supervisory/middle management staff would benefit from training to improve management and interpersonal skills; and
- considering the potential for improving interaction among staff by providing them with opportunities to learn more about other departments (the intent of this recommendation was to improve safety culture and the interaction between staff in different parts of the organisation).

242 ORR sent a ‘final’ version of this report to TOL on 5 March 2013. TOL stated that it met with ORR on 19 April 2013 to go through this report ‘line by line’ as it had some concerns with its findings and the clarity of its recommendations. Although TOL expected to receive an updated report following this meeting, none was received. However, TOL considered the findings of the report received on 5 March 2013 and recorded a response to each recommendation. These included a commitment to continue the biennial staff surveys, and to incorporate interpersonal skills training into a management development plan that was intended to encompass middle managers and supervisors.

243 ORR told the RAIB that, because it had not identified any serious failings with TOL’s management of staff, including its tram drivers, no follow up action was deemed necessary.

Drivers’ reported perception of TOL management

244 The RAIB’s driver questionnaire asked TOL’s tram drivers about their relationships with their direct line manager (a line controller) and with senior managers within TOL²⁷. They were asked to rate these relationships between 1 and 10. A rating of 1 indicated that their manager was difficult to talk to, there was a lack of trust or a ‘them and us’ attitude was perceived. A rating of 10 indicated a healthy relationship, an open-door policy and good support. Table 12 shows the results of this question.

Relationship	Average rating between 1 (low) and 10 (high)	Most frequent rating between 1 (low) and 10 (high)
Driver with line controller	3.9 (average of 58 responses)	3 (13 drivers gave this response)
Driver with senior manager	3.6 (average of 58 responses)	1 (13 drivers gave this response)

Table 12: Relationships with line controllers and senior managers as assessed by tram drivers who responded to the RAIB’s questionnaire

245 The average results for both relationships, driver with line controller and driver with senior manager, are similar and suggest a lack of trust in drivers’ relationships with these staff. More drivers rated their relationship with a senior manager at a lower level than their relationship with a line controller.

246 The questionnaire results also suggest a belief among some tram drivers that there is a blame culture within TOL (paragraph 228). Suggestions of a blame culture can also be found in TOL procedure SM0007 ‘Management of signals passed at stop’ which says that ‘formal disciplinary proceedings will always be implemented where a driver is alleged to have been wholly or partially responsible for passing a signal at stop’.

²⁷ Possible influences on questionnaire responses are described at paragraph 91.

247 The independent survey undertaken before the accident on behalf of TOL in 2016 (paragraph 231) measured the overall levels of staff engagement by asking staff to indicate the extent to which they agreed with various statements. Although direct comparison with the RAIB survey is not possible because the two surveys took place in very different contexts and used different questions, the following responses to the FirstGroup survey provide evidence that the views and attitudes of employees were more positive before the accident than suggested by the RAIB's post-accident survey:

- 'I have confidence in the decisions made by the Senior Management' (46% of tram drivers, 54% of all staff).
- 'In my team we try hard to improve how we work together' (57% of tram drivers, 63% of all staff).
- 'I believe Tram Operations Ltd. is dedicated to safety' (81% of tram drivers, 86% of all staff).
- 'In my team, if it isn't safe, we don't do it' (76% of tram drivers, 80% of all staff).

Learning from customer complaints

248 TOL had several systems for logging near misses including signals passed at stop (SPAS), derailments with minor consequence, objects on the track, customer complaints and hazard brake applications. The RAIB reviewed TOL's records of customer complaints received through TfL's website, as well as driver reports of hazard brake applications, to determine whether it would have been possible for TOL to combine these two data sets in order to improve its understanding of risk associated with overspeeding on curves. The RAIB reviewed data from 1 January 2014 to 8 November 2016 and concluded that, in addition to incomplete reporting of hazard brake applications by drivers (paragraph 227), it was impractical to use customer complaint data to improve understanding of overspeed risk on curves because:

- it was difficult to identify the events corresponding to customer complaints about sudden/hard braking because, for most customer complaint entries, the exact time, and often the actual date of the event, were not provided;
- customer perception of braking (harsh, heavy, sudden etc) does not necessarily reflect whether the hazard brake was used;
- the locations where events were reported by customers are difficult to match to precise locations such as a specific curve or its approach; and
- many customer complaint entries implied that emergency/hard braking was involved, but do not actually say this.

Managing the risk of overspeeding around curves

249 The risk associated with excessive speed on curves was neither fully understood by the safety regulator nor adequately addressed by UK tramway designers, owners and operators.

250 Prior to the opening of the Croydon tramway in 2000 the infrastructure and trams were approved by HMRI (paragraph 68) in accordance with the Railways and Other Transport Systems (Approval of Works, Plant and Equipment) Regulations 1994. The approval of the tramway was given on the basis that it complied with relevant standards, legal requirements and regulatory safety guidance that prevailed at the time.

251 The only warning provided to tram drivers approaching the curve at Sandilands in darkness was a sign that was not visible until the driver had passed the point at which the tram's speed could be reduced to the required speed by application of the hazard brake. No other mitigation, other than drivers' route knowledge, was provided against the risk of travelling around the curve at excessive speed. It is possible that improved signage, or audible warnings, would have given a stronger cue which would have prompted the driver to slow the tram to a speed at which it would not have overturned. Overturning could have been avoided by an effective system for applying the tram brakes automatically if the tram was approaching the curve too fast.

UK tramway guidance

252 The provision of the speed sign, and the absence of other mitigation at the curve, was consistent with the design guidance given in RSPG-2G and RSP2 (paragraph 69). The technical content of RSPG-2G had been developed while the earliest of the second generation of UK tramways were being designed and opened. Both documents reflect the widely held views of both the tram industry and the regulator (HMRI and ORR) with the foreword of both documents acknowledging that HMRI *'is indebted to the very many people who have contributed to the development of this document'*.

253 Although consistent with RSPG-2G and RSP2, the mitigation against overspeeding on the approach to Sandilands was less than would have been provided in comparable situations on European tramways (paragraph 260), UK roads (paragraph 269) and UK railways (paragraph 274). It is likely that direct application of these arrangements would have been inappropriate on the Croydon tramway. However, the lack of any comparable arrangements shows that the risk associated with serious accidents on curves had not been fully appreciated by the UK tram industry or its safety authority.

254 RSPG-2G was applicable when Croydon tramway was opened in May 2000 and stated that:

[RSPG-2G gives] examples of established good practice acceptable to [HMRI] to provide an acceptable level of safety for the public (passengers and others)' (RSPG-2G paragraph 2);

'application of this guidance should provide a sufficient level of safety for approval to be given by [HMRI], provided that it has been demonstrated that the use of the guidance is wholly applicable to the works, plant or equipment' (RSPG-2G paragraph 3); and

'where arrangements which differ from those set out in this guidance are proposed, those responsible for submitting the works for approval [by HMRI] will be expected to demonstrate that such arrangements provide an equivalent level of safety' (RSPG-2G paragraph 11).

255 RSPG-2G includes an illustration of a speed sign similar to that at the start of the curve at Sandilands. The accompanying text stated:

'the [sign] should be large enough to be seen clearly' (RSPG-2G Appendix A paragraph 3); and

'Approved lineside signs... should be located wherever...the maximum permitted speed on a section of tramway changes' (RSPG-2G paragraph 213 (b)).

256 RSPG-2G did not give dimensions for speed signs, other than a size ratio of 3:2 (height : width). The speed sign at Sandilands was of similar size to others on the Croydon tramway and elsewhere on UK tram networks.

257 RSPG-2G makes no mention of signage warning of a speed reduction ahead and no mention of a need for automatic application of brakes on a tram approaching a hazard at excessive speed. No maximum speed is given for operation of trams except when sharing a road with other vehicles.

258 When using authoritative documents such as RSPG-2G, tramway designers and engineers in many fields would not necessarily expect to provide mitigation in addition to that described in the guidance, unless there is a clear prompt to do so. Prompts can include document text suggesting other factors to be considered, or designers using a document in circumstances for which it is not intended, but for which it may provide helpful advice (for example, a document relating to safety management in another industry). No relevant prompts have been found in respect of using RSPG-2G to design mitigation at Sandilands south curve.

259 A survey of other major UK tram systems found that, before the accident at Sandilands, signage at speed restrictions was generally similar to that at Croydon and comprised only a standard speed sign at the start of the restriction. The exception was six locations on the Manchester system where additional signage was provided at locations considered to be particularly high risk. Additional signage was added on four UK tramways after the RAIB issued an Urgent Safety Advice (Appendix F) based on preliminary findings from the Sandilands investigation.

European tram practice

260 Selected aspects of Western European tramway practice have been reviewed by TÜV Rheinland on behalf of the RAIB. This considered situations similar to Sandilands where a tram approaching at relatively high speed must reduce speed significantly in order to comply with a speed restriction. No examples have been found where a single speed sign at the start of a speed restriction would be used where a large speed reduction is required in an area operated on the line-of-sight principle.

261 The German BOStrab²⁸ standard requires the speed sign at the start of the restriction to be supplemented by an advance warning sign where local conditions mean that the sign at the start of the restriction cannot be seen from a sufficient distance. Examples from the Cologne tramway (figure 29) are used by TÜV Rheinland to demonstrate the provision of advance warning signs on German tramways where line-of-sight driving is used at a location where the maximum permitted speed reduces from 70 km/h (43 mph) to 20 km/h (12 mph).



Figure 29: BOStrab advance warning of speed restriction on the Cologne tramway

262 Guidance published in 2014 by Service Technique des Remontées Mécaniques et des Transports Guidés (part of the French government's Department of Infrastructure, Transport and Sea) limits the maximum speed reduction and is considered as good practice by tramway designers. Applied to the Sandilands south curve, a tram approaching at a speed of 80 km/h would encounter signs giving three intermediate speed restrictions (eg 60 km/h, 40 km/h and 30 km/h) before encountering a 20 km/h speed sign. TÜV Rheinland also identified instances of advance warning signs being used on the Lyon tramway.

263 TÜV Rheinland reported that Dutch law does not contain detailed requirements regarding speed signage but that the Amsterdam tramway uses advanced warning signs before speed restrictions in areas driven on the line-of-sight principle.

264 The 80 km/h approach speed to the south curve at Sandilands is the maximum permitted speed on UK tramways and European tramways in areas driven line-of-sight (eg Manchester and Montpellier, France).

²⁸ German Federal Regulations on the Construction and Operation of Light Rail Transit Systems, issued 11 December 1987.

- 265 Operation at 80 km/h (50 mph) is permitted in France according to the current guidance issued in 2014 by Service Technique des Remontées Mécaniques et des Transports Guidés. The same limit is given in 'Guidelines for selecting and planning a new light rail system', issued by the International Union of Public Transport, which states 'if a bus, guided-bus, trolleybus or light rail alignment is *segregated*, fenced from other traffic and pedestrians, speeds could go up to 80 km/h (or more in the case of underground or suburban railway operation)'.
- 266 BOStrab limits the maximum speed of trams driven line-of-sight to 70 km/h (43 mph). Witness evidence suggests that the safety authority at the time the Croydon tramway was approved (HMRI) considered that the BOStrab requirement limiting line-of-sight operation to 70 km/h (43 mph) related to the first generation of trams that had inferior braking performance when compared with modern 'second generation' trams.
- 267 Though BOStrab restricts line-of-sight operation to speeds of up to 70 km/h (43 mph), it permits higher speeds if signal systems similar to those used on railways are installed. These can be supplemented by devices which stop trams automatically if, for example, they attempt to pass a signal showing a stop aspect. Controls of this type would be required by BOStrab for a tramway operating at 80 km/h (50 mph). None of the factors affecting the Sandilands accident are related to the difference between maximum permitted speeds of 70 km/h (43 mph) and 80 km/h (50 mph). The accident could have happened if the maximum permitted speed on the Croydon tramway was 70 km/h (43 mph).
- 268 Line-of-sight driving is not permitted by BOStrab through tunnels, except short tunnels on street-running sections where the entire service braking distance is visible. A project manager for the initial development phases of the Croydon tram system stated that the 80 km/h (50 mph) running was permitted through the Sandilands tunnels because they were illuminated throughout, and were straight, thus providing a good view ahead (figure 20).

UK road practice

- 269 The RAIB commissioned TRL to identify the road signs and warnings²⁹ which would be considered good practice on a theoretical road similar to the tramway location at which the accident occurred. The theoretical road had a speed limit of 80 km/h (50 mph) and a tunnel on the approach to a tight left-hand bend. TRL concluded that, as a minimum, a triangular 'bend ahead' warning sign 600 mm high would be located between 60 and 75 metres before the start of the bend, and chevron signs, 600 mm high (or possibly 800 mm high to improve conspicuity) would be provided to mark out the bend itself. To further improve conspicuity, the 'bend ahead' warning sign and chevrons signs would be mounted on reflective rectangular yellow backing boards (figure 30).
- 270 TRL also considered that the presence of the tunnel would mean that the maximum permitted speed of the approach would be either 40 mph (64 km/h) or 30 mph (48 km/h) with TRL believing 30 mph (48 km/h) would be appropriate for the Sandilands layout. The speed limit would apply from the start of the Sandilands tunnels.

²⁹ Advice on signage and warnings is given in the 'Traffic signs manual' available at <https://www.gov.uk/government/publications/traffic-signs-manual>

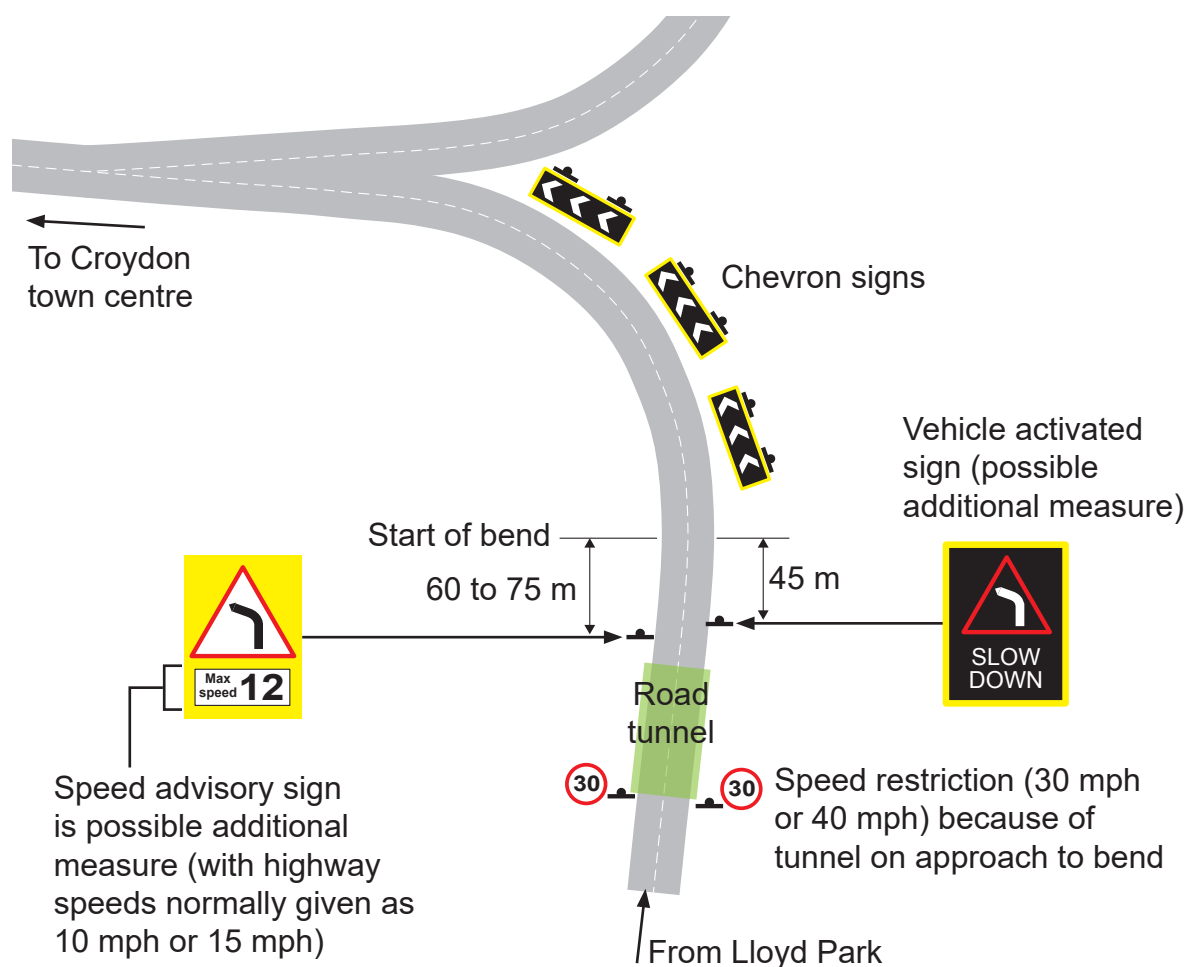

Figure 30: Normal and additional optional signing for similar road bend (additional signage required if junction equipped with traffic lights)

271 TRL identified a number of additional measures that could be provided on a road with similar features to the tramway at Sandilands, including a vehicle activated sign at a distance of around 45 metres from the start of the bend and a maximum speed sign underneath the 'bend ahead' warning sign. Traffic advisory leaflet 1/03 'Vehicle activated signs' issued by the Department for Transport³⁰ provides guidance on the use of such signs and states that 'Vehicle activated signs have been developed to address the problem of inappropriate speed where conventional signing has not been effective'.

272 The speed limit signs for trams are different from those used for other road vehicles (figure 31) and both are described in The Traffic Signs Regulations and General Directions. TRL compared the surface area of the tramway speed sign from Sandilands with the equivalent road maximum speed sign that would be located on a road at which vehicles can approach at a maximum speed of 50 mph (80 km/h) (table 13). The tram speed restriction sign at Sandilands junction at the time of the accident had a surface area only 43% of that of an equivalent road speed limit sign. Therefore, the tram speed restriction sign will be less conspicuous than an equivalent road speed limit sign when installed in the same physical location with the same level of background lighting.

³⁰ Available from: <https://www.gov.uk/government/publications/traffic-advisory-leaflets-1989-to-2009>



Figure 31: Maximum speed signs (to same scale) for trams (left image) and road vehicles (right image)

Sign intended for	Sign height	Sign width	Sign area
Tram at Sandilands south curve	603 mm	401 mm	0.121 m ²
Other vehicles on a public road	600 mm	600 mm	0.282 m ²

Table 13: Tram and road speed sign dimensions

273 It is not always necessary to provide tram drivers with the signage provided for other road users because tram drivers are expected to have well established route knowledge repeatedly reinforced by driving the route frequently. This makes them different from many road users, including some drivers of coaches and buses, who may be encountering speed restrictions, sharp curves or obscured sight lines for the first time as they drive along a previously untraversed road. However, in the absence of any other protection, tramway signage is the only mitigation for a hazard if a tram driver becomes disorientated or loses awareness, and consideration of road sign principles indicates that a single speed sign at the start of a tramway speed restriction is sometimes insufficient.

UK rail practice

274 The main line rail accident at Morpeth in 1969 (table 10, paragraph 220) led to the introduction of advance warning signs with *automatic warning system* (AWS) equipment on the approach to speed restrictions at locations where there was a risk of trains overturning on curves. The subsequent accident at Morpeth in 1984 (in the other direction, table 10) resulted in additional requirements for advance speed restriction warning signs and AWS equipment. The risk of overspeed on curves was further reduced when the *train protection and warning system* (TPWS) was fitted on the UK main line railway network, an enhancement completed in 2003.

- 275 TPWS will automatically apply the train's brakes if the system detects that a train is travelling too fast on the approach to permanent speed reductions at locations, including curves, where the permissible speed on the approach is 60 mph (97 km/h) or higher, and the reduction in the permissible speed is at least one-third.
- 276 Reducing risk due to a train overturning was one of the criteria used to establish the curves requiring TPWS. The risk of overturning increases as curves become tighter, and tramway curves such as that at Sandilands are considerably tighter than on the main line railway. Overturning risk is therefore present at lower speeds on tramways. This was demonstrated at Sandilands south curve when tram 2551 overturned at a speed of 70 km/h (44 mph) and subsequent analysis showed that a speed of 50 km/h (31 mph) was sufficient to cause overturning. TPWS requirements do not apply to tramways such as Croydon but, if the principles used to determine main line locations requiring TPWS were applied to tramways, curves such as that at Sandilands would require TPWS.

Factors affecting the consequences

277 The principal cause of fatal and serious injuries in this accident was the ejection (full or partial) of passengers through the windows and doors on the right-hand side of the tram.

278 The RAIB carried out a thorough examination of tram 2551, and a review of passenger injuries to establish how they were caused and whether any safety lessons could be learned.

Tram damage

Damage to tram body structure

- 279 The right-hand side of the tram (which landed on the ground) and the roof were damaged during the accident. Figure 32 shows the most significant areas of damage to the body structure.
- 280 Witness marks on the tramway infrastructure and on the body structure of the leading vehicle indicated that this vehicle had made significant contact with:
- the *six-foot* rail of the adjacent line (the south curve outbound line, figure 11), struck along the leading bottom edge of the tram (Appendix G, figure G.4);
 - an OHLE support mast, struck along the tram roof (figure G.6 and G.7); and
 - the *cess rail* of the north curve inbound line, struck along the tram bodyside (figure G.7).
- 281 Witness marks on the tramway infrastructure and the body structure of the tram articulation unit indicated heavy contact with a rail, likely to be the six-foot rail of the south curve outbound line as the tram first overturned.
- 282 Witness marks on the structure of the trailing vehicle of the tram indicated that the right-hand side *cantrail* had made significant contact with:
- the electrical equipment cabinet (figure G.8); and
 - spare rails and the ground.

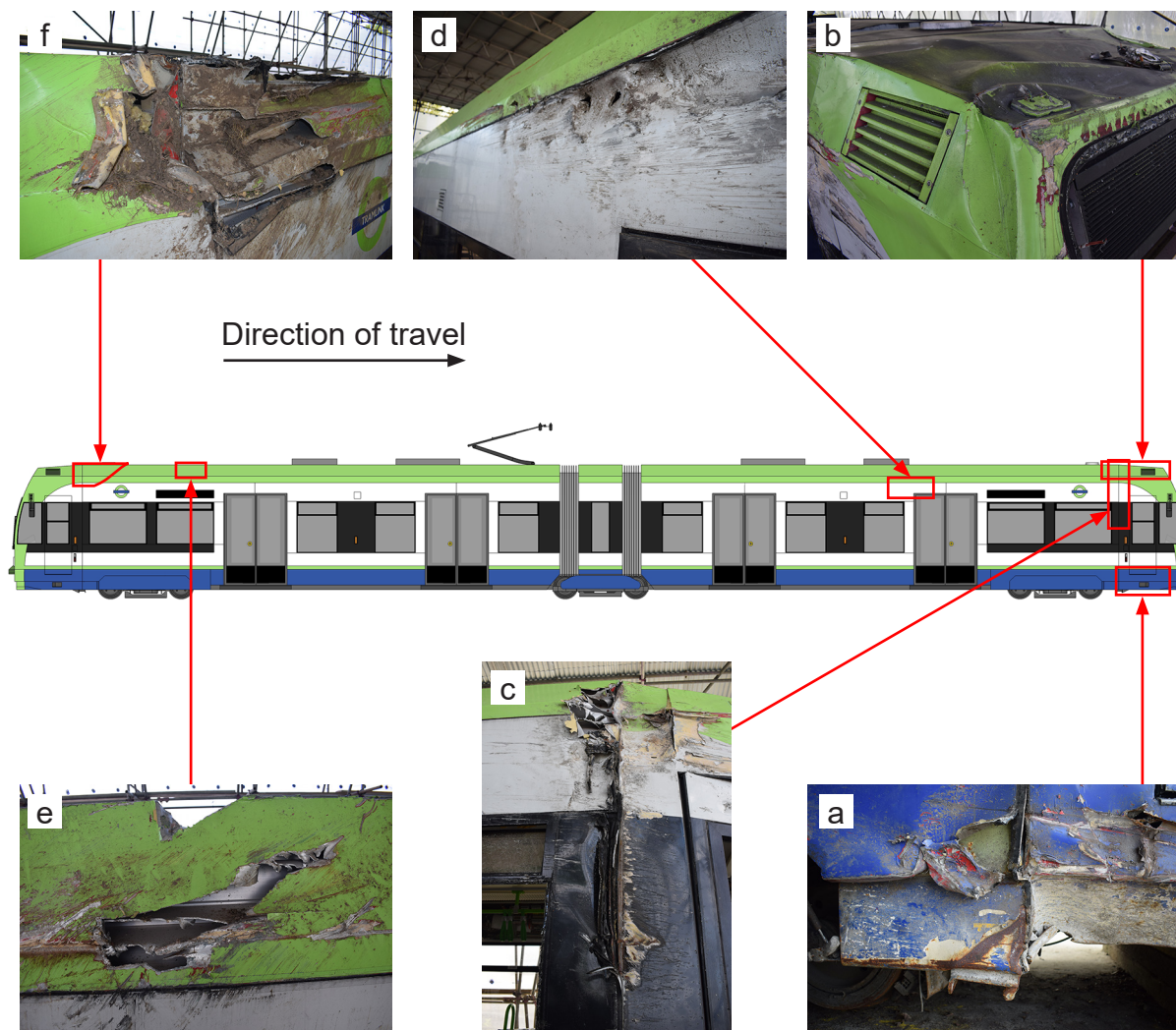

Figure 32: Significant areas of damage to tram 2551

283 In addition, there was evidence, including scratches on the tram body structure, indicating that the tram slid on the track of the south curve outbound line for a distance of about 9 metres. Finally, there was evidence that the tram bodyside had been displaced inwards in localised areas following the contact with the rails and ground. This inward displacement was small (less than 50 mm) but would have been enough to damage the windows in those locations.

284 The detailed examination of the tram concluded that the body structure largely kept its shape, despite evidence of some hard contact points with the infrastructure and tracks. There were local outer skin penetrations at some of these contact points but no intrusion of infrastructure objects into the passenger space. Consequently, there was no loss of *survival space*.

Damage to windows

285 There are four sizes of bodyside windows on CR4000 trams and two different thicknesses, as shown in table 14. This table does not cover the *hopper windows*, cab windows or windscreens. Figure 33 shows where each type of window is fitted. Figure 34 shows a typical window arrangement.

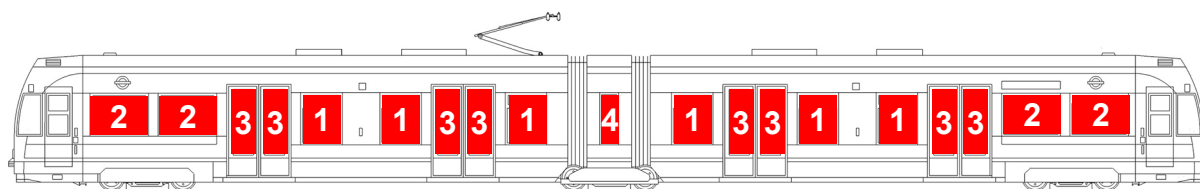

Figure 33: Window layout on tram 2551



Figure 34: Typical window installation on a CR4000 tram

Type	Location	Size (mm)	Thickness (mm)
1	Bodyside	970 x 1000	6
2	Bodyside	750 x 1438	6
3	Door	1690 x 670	4
4	Bodyside	1260 x 404	6

Table 14: Bodyside window sizes and thickness

286 The passenger windows fitted to tram 2551 were replaced in September 2016 as part of a major refurbishment of the tram fleet. The RAIB confirmed that the windows fitted during the refurbishment were of the specified thickness and type (table 14). The large passenger windows (types 1, 2 and 4) were 6 mm thick and the door windows (type 3) were 4 mm thick. All these windows were made of toughened glass.

287 On the right-hand side of the tram, all of the large passenger windows (types 1, 2 and 4) and all of the passenger door windows (type 3) shattered as a result of the accident. Figure 35 shows the location of window damage on the right-hand side of the tram.

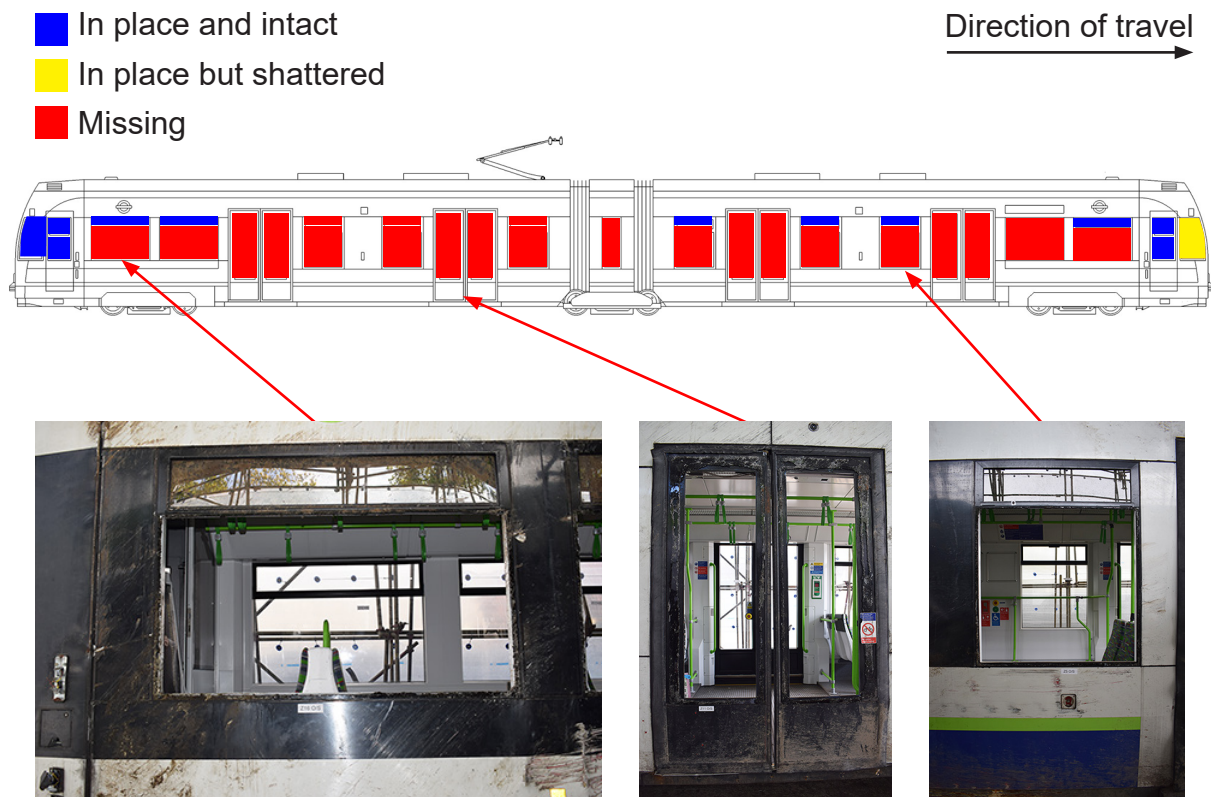

Figure 35: Damage to windows on right-hand side of tram 2551

288 All the windows on the left-hand side (types 1 to 4) remained intact.

289 The bodyside windows and door windows are bonded onto the tram structure or door frame using a glass bonding adhesive widely used across the automotive industry (Betaseal, manufactured by the Dow Chemical Company).

290 Each window is fitted with an anti-vandal film on its inside face. Apart from the door windows, this anti-vandal film is fitted to the windows after their installation onto the vehicle. As a result, it is not trapped between the adhesive and the glass.

291 The RAIB examination found no evidence that the overall failure of the window system was due to a weakness in the bond. Once shattered, the windows became dislodged from the tram along the line defined by the perimeter of the anti-vandal film. A typical window failure is shown in figure 36. The remains of the dislodged windows (the anti-vandal films with some diced glass bound to the films) were found distributed along the track within the debris field.

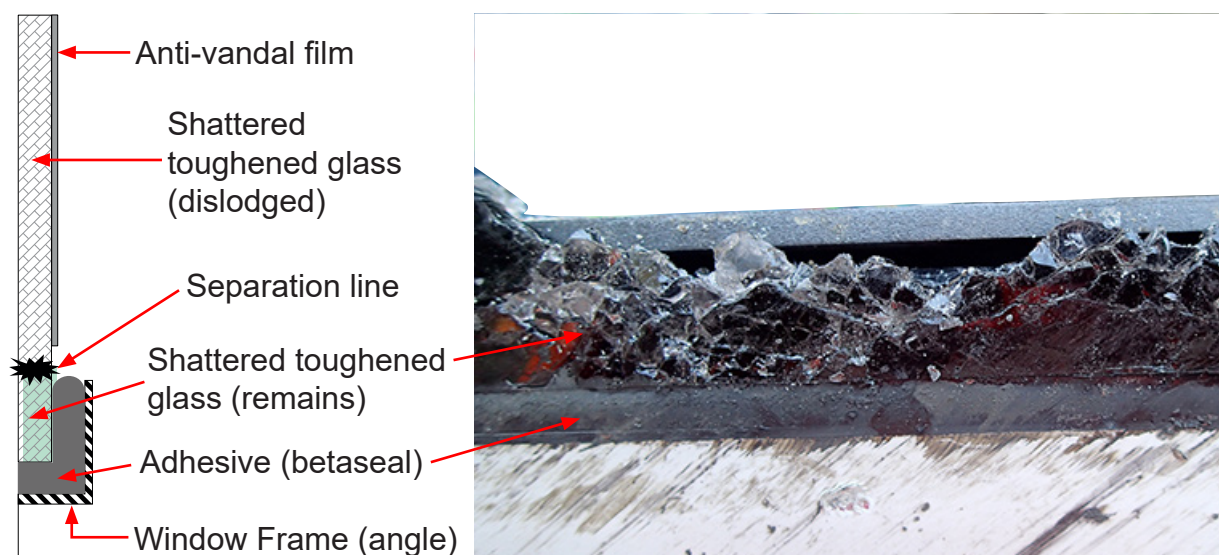

Figure 36: Typical failure mode of the tram's windows

Damage to doors

- 292 There are four sets of double passenger doors on either side of a CR4000 tram. The doors are of a *plug type* and hence normally sit flush with the outer skin of the vehicle structure when fully closed. The door leaves (figure 37) are hung at the top from a bracket which carries the weight of the door and drives the doors along the longitudinal axis during door opening and closing operations (figure 38a). An arrangement consisting of an inverted U shaped channel and rollers along the bottom of the door (two rollers running inside the channel, and one outside the channel) provides the door with a degree of lateral restraint (figure 38b). Some doors on the tram are fitted with a metal bracket intended to prevent the roller being pulled out of the channel.
- 293 As a result of the accident, three door leaves became fully detached from the tram and an additional two door leaves became partially detached. Figure 39 shows the location of the damage to the doors and a detached door is shown in figure 40.
- 294 The door itself is constructed from aluminium extrusions which are connected with each other at the corners using an aluminium casting and two screws. The casting is bonded (glued) inside the extrusions. The typical failure mode was across the casting itself with the screws being pulled from the extrusions as they became overloaded (figure 41).

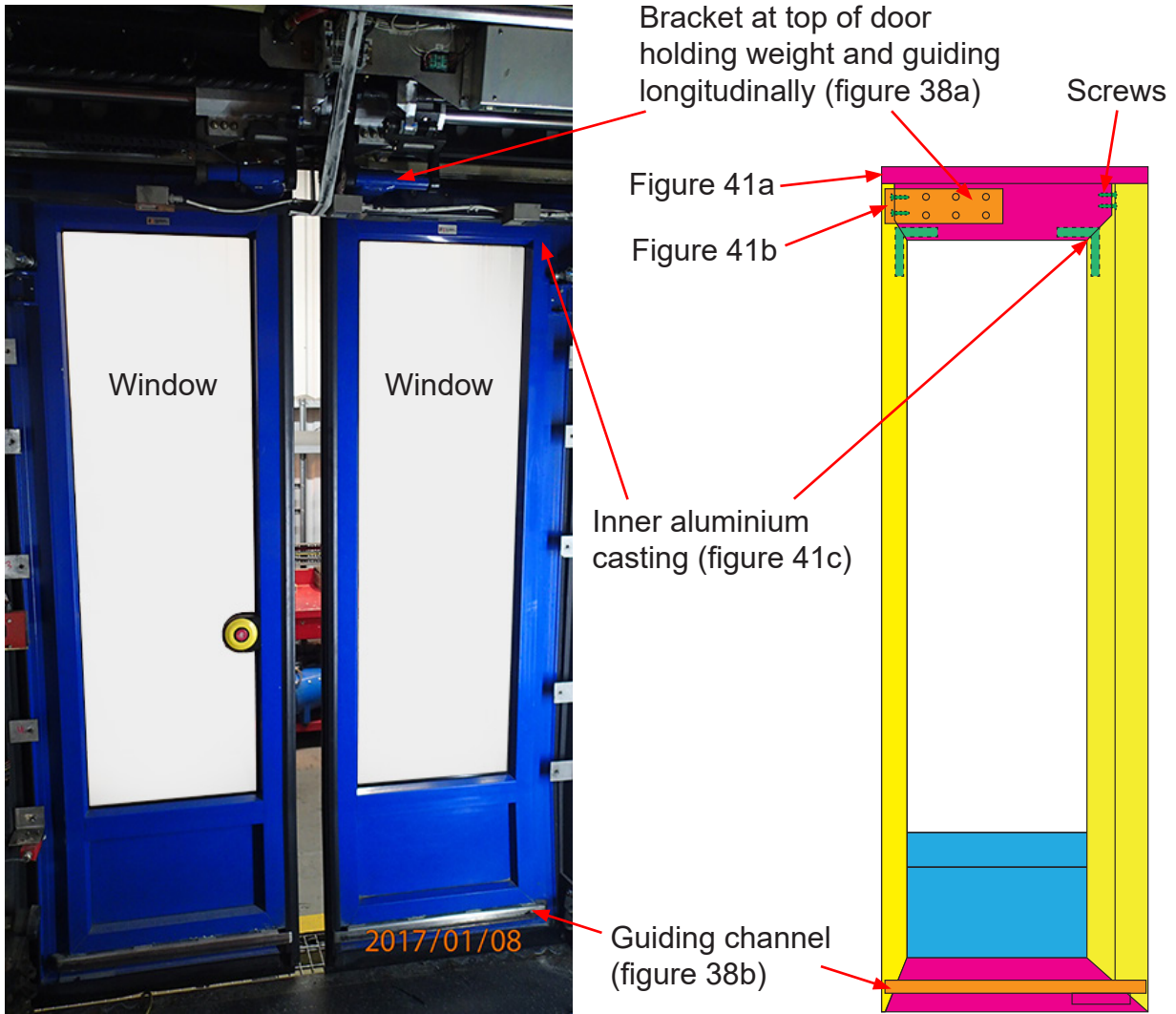

Figure 37: Photograph of door pair and diagram of a single leaf showing key features

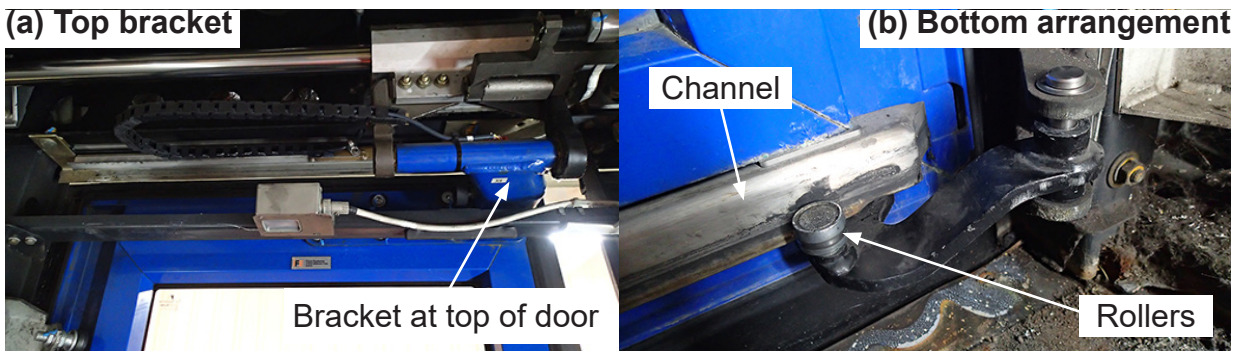

Figure 38: Door securing arrangement

■ In place and mostly intact (but broken glass)

■ In place but several key joints broken (and broken glass)

■ Detached during accident (and broken glass)

Direction of travel
→

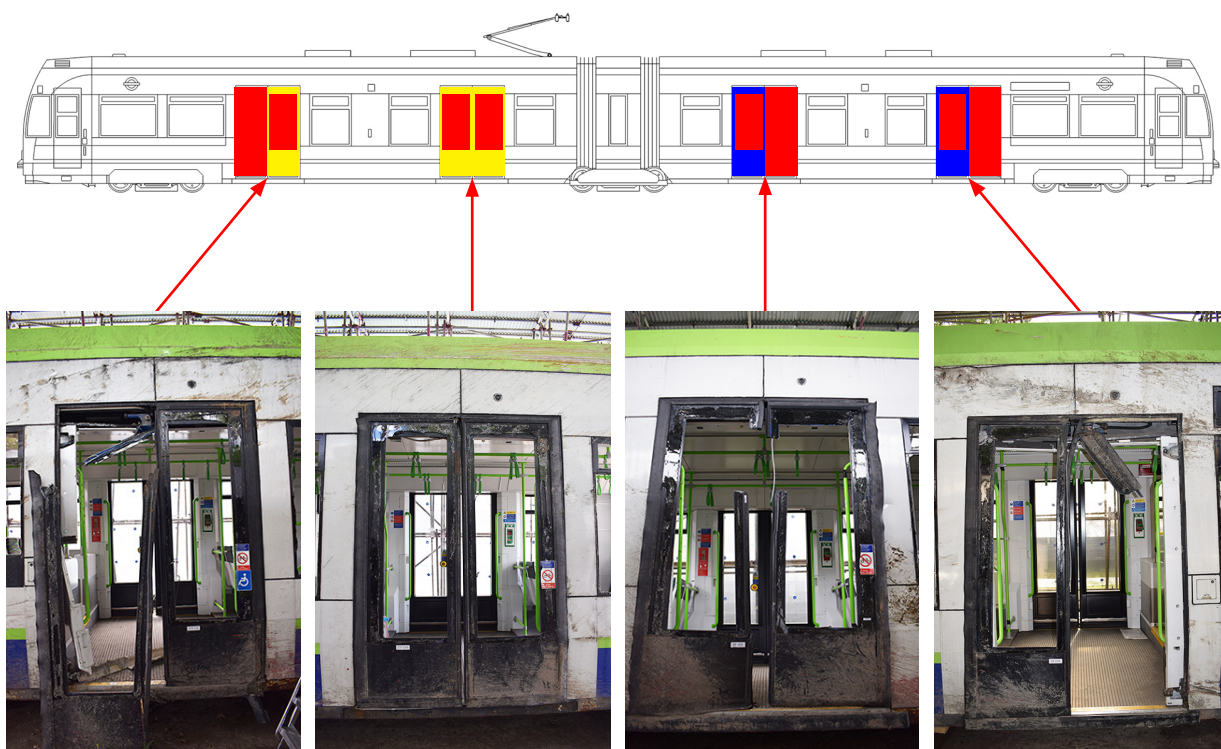

Figure 39: Damage to the tram's doors (note that in the third photograph the right-hand door has been repositioned)



Figure 40: Typical door damage

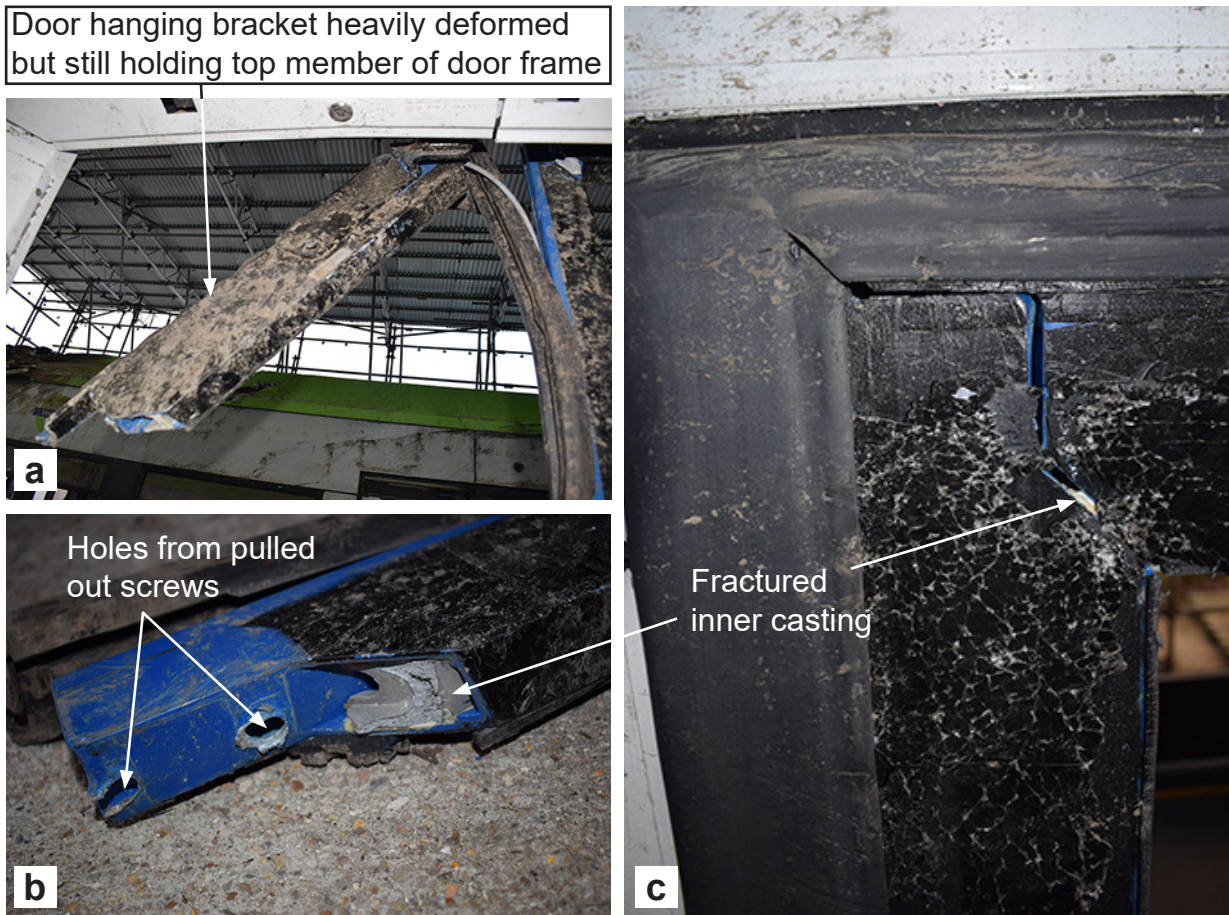

Figure 41: Typical door failure mode (see figure 37 for component locations)

Damage to tram interior

295 The RAIB's post-accident examination of the tram interior looked at the integrity and damage to the following key items of internal furniture:

- seats;
- handrails;
- internal trim panels;
- *cantlockers* (overhead cupboards that house electrical and mechanical equipment);
- light diffusers; and
- floor covering.

296 This examination revealed that the interior of the tram remained largely intact during the accident. One seat became fully detached but did not become a projectile as it remained in situ. Two additional seats were found partially detached but again in situ.

297 As the tram is intended to carry 138 people standing, in addition to 70 people seated, many handrails are provided. Some of these handrails had been deformed during the accident indicating contact with falling passengers (figure 42 shows the extent of the damage to handrails). However, no handrail had fractured to reveal sharp edges likely to cause life-threatening injuries on secondary impact.



Figure 42: Extent of damage to handrails

298 None of the light diffusers or cantlockers came adrift. Most of the internal trim panels were undamaged. Some were found to be cracked, but it was unclear whether this had happened during the accident or during egress (as passengers had to walk on them to leave the vehicles). Only a few panels had cracked in such a way as to create sharp edges capable of injuring passengers during secondary impacts. Figure 43 shows a typical picture of the interior post-accident.

Causes of injury

Injury severity distribution

299 The RAIB has considered the severity of the physical injuries sustained by passengers and how those injuries were caused. Injuries were analysed using information from:

- post-mortem reports;
- photographic evidence;
- passenger accounts; and

- accounts from the medical professionals who treated the injured passengers at the local hospitals.

The analysis has not attempted to capture or quantify the level of the psychological trauma suffered by passengers. Witness evidence describes the severe distress caused to those involved.



Figure 43: Typical interior area of tram, post-accident

300 The Railways (Accident Investigation and Reporting) Regulations 2005 (RAIR regulations) provide a definition of what constitutes a serious injury for the purpose of this assessment. Examples of serious injuries include: amputation, a fracture other than to fingers, thumbs or toes and an injury requiring admittance to hospital for more than 24 hours. The injuries sustained by those on the tram were classified using the criteria in the RAIR regulations. The distribution of fatal, serious and minor injuries for people on the tram is given in table 15. Of the 69 passengers on the tram, only one reported having suffered no injury as the result of the accident.

	Number of passengers	Staff (tram driver)
Fatal injuries	7	
Serious injuries	19	
Minor injuries	42	1
No injury	1	
Total	69	1

Table 15: Distribution of injury severity

301 The RAIB sought professional medical advice for a more detailed assessment of the nature of the injuries and their likely causation. The detailed assessment provided an *injury severity score* (ISS) for each passenger. This reflected the overall condition of people with multiple injuries and is most often used in emergency trauma care.

302 The ISS is obtained by first using an internationally recognised dictionary³¹ to obtain an *abbreviated injury scale* (AIS) for each injury. This ranges from 1 for a minor injury to 6 for an injury that is thought to be ‘incompatible with life’. The ISS for each passenger is determined by focussing on their three most severely injured body regions. The highest AIS in each of these body regions is squared and the three results added together to give the ISS.

Injury distribution

303 As far as possible, the RAIB identified the location of each passenger on the tram using witness accounts and CCTV recordings from the tram stops along the route (as noted at paragraph 408 the CCTV fitted to tram 2551 was not recording). The RAIB mapped the ISS against the location of the passengers inside the tram. When assessing the severity of injuries the RAIB, with the assistance of a medical expert, chose an ISS value greater than or equal to 5 as being indicative of passengers with significant injuries. This gave an overall number of passengers with significant injuries similar to the number defined as seriously injured by the RAIR regulations. This showed that:

- all passengers who were fatally injured (with the possible exception of one whose pre-accident position is uncertain) were located on the right-hand side of the tram in the direction of travel before the accident; and
- the proportion of passengers with an ISS greater than 5 was higher in the trailing vehicle (10 passengers out of 32 in trailing vehicle) than in the leading vehicle (4 passengers out of 35 in leading vehicle). There were two passengers travelling in the articulation unit, neither had an ISS score greater than 5.

Injury causation

304 The injury causation mechanisms commonly encountered in railway and tramway accidents are as follows:

- crushing (where the vehicle structure collapses and crushes the occupants);
- ejection (where the vehicle structure fails to contain occupants who are ejected outside the vehicle);
- penetration (where an external object penetrates inside the vehicle and strikes an occupant);
- secondary impact (where the occupant is thrown against the interior fixtures or other occupants as the vehicle decelerates);
- burns (where the occupant comes in contact with hot surfaces/fire); and
- on exit (injuries sustained during evacuation).

³¹ Published by the Association for the Advancement of Automotive Medicine (USA).

305 The RAIB and its medical expert reviewed the accounts given by the passengers and the medical professionals who treated their injuries to determine what the main injury causation mechanisms were. The RAIB found that the only causes of significant injuries in this accident were ejection (full or partial) and secondary impacts. There is no evidence to suggest that any of the other injury causation mechanisms were encountered. Figure 44 shows the distribution of ejection and secondary impact injuries.

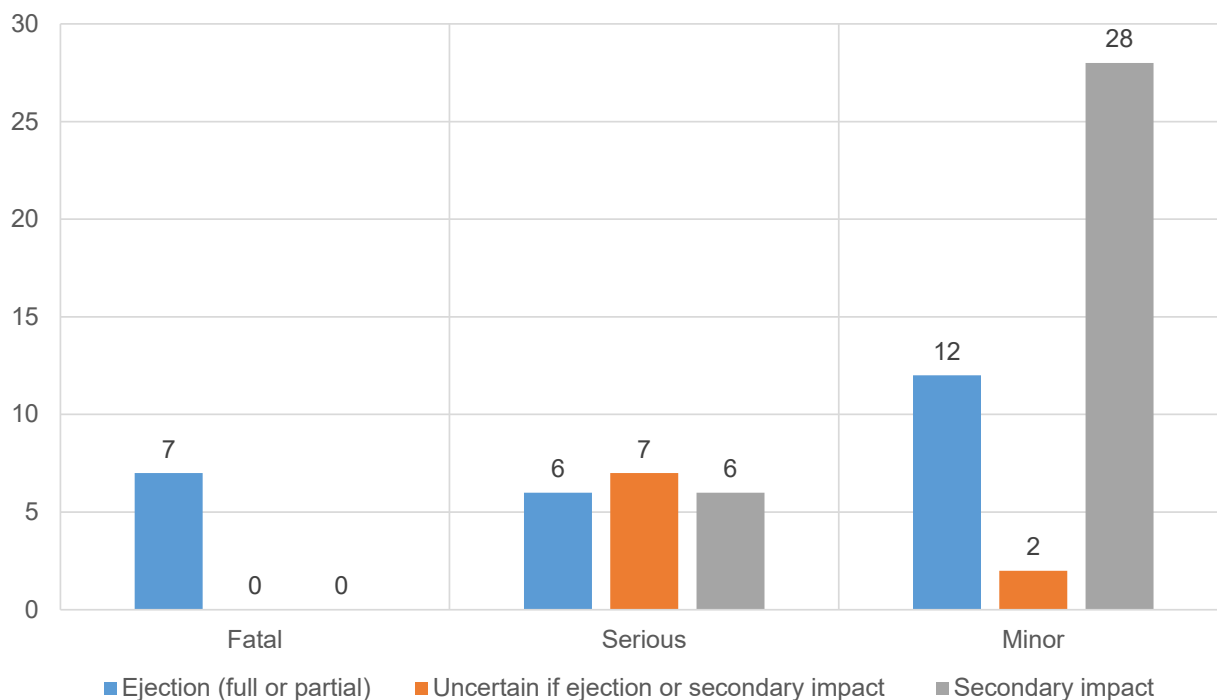

Figure 44: Primary cause of passenger injuries

Ejection

306 The seven passengers who were fatally injured were all fully or partially ejected from the tram. In general, the ejection resulted in the passengers sustaining injuries consistent with being crushed between the tram and the ground.

307 Twenty-seven surviving passengers described how, immediately after the accident, they found themselves either partially or completely ejected from the vehicles and lying on ballast and rails on the ground (there were spare rails stored at the location, paragraph 282). Thirteen of these passengers suffered serious injuries although some of these injuries may have been caused by secondary impacts.

308 Overall, half of the passengers (34 out of 69) were either fully or partially ejected during the accident. Ejection was therefore the principal cause of injury in this accident. Ejection was possible because all of the windows and some of the doors became dislodged from the vehicle (paragraphs 287 and 294), leaving around 33% of the tram's right-hand side exposed to the ground (figure 45).



Figure 45: Tram 2551 overturned at accident site showing ground beneath broken windows (rails had been stored on the ground between the north and south curves before the accident, see figure 8)

Secondary impacts

309 Secondary impact injuries are to be expected when a tram overturns, not least because, in common with trains and urban buses, none of the passengers are restrained. The review of the injuries demonstrated that all of the injured exhibited signs of secondary impact. However, an examination of the tram interior post-accident did not identify any specific features of the design which would have exacerbated these injuries.

Crashworthiness performance of the tram

Standards

310 The tram was designed to be compliant with the following relevant standards:

- British Standard BS857:1967 - 'Safety glazing for land transport' which defines the fragmentation requirements for toughened and laminated glass. This standard was and remains commonly referred to in the railway and tramway industries.
- VDV³² Recommendation 152: Sept/92 – 'Structural requirements for rail vehicles for the public mass transit in accordance with BOStrab' which defines the static and fatigue strength requirements for the tram body structure and attached equipment. This was and remains one of the main standards used in the tramway industry.
- RSPG-2G – HMRI tramway guidance described at paragraph 69.

³² Verband Deutscher Verkehrsunternehmen (Association of German Transport Companies).

Windows

- 311 As tram 2551 overturned, all of the right-hand bodyside windows shattered and became dislodged. The door windows also became dislodged. This left large holes through the bodyside for passengers to fall through and be ejected, either fully or partially.
- 312 The windows fitted to tram 2551 were made of toughened glass to BS857. Toughened glass is a type of safety glass which has been subjected to thermal or chemical treatments to increase its strength. The treatment results in the glass being pre-stressed so as to break in small pieces when impacted, instead of large shards. The small pieces are less likely to cause serious injury.
- 313 Laminated glass is another type of safety glass. It holds together when shattered. The glass is typically made of three layers: two panes of glass on either side of a polyvinyl butyral (PVB) interlayer. It is the PVB interlayer which keeps the glass together even when broken.
- 314 BS857 is the standard referred to in the railway and tramway industries for glazing requirements. It specifies a suite of requirements for both toughened and laminated glass. BS857 does not specify which type of glass (toughened or laminated) should be used on railway and tramway vehicles. There are requirements within the standard which are specific to toughened glass when used in a railway vehicle but these requirements relate only to flatness, light transmission and visual appearance. It does not specify any impact requirements for toughened glass.
- 315 The review of current tram designs across Europe undertaken by TÜV Rheinland (paragraph 260) reported that toughened glass is commonly used on tramway vehicles for all bodyside windows.
- 316 RSPG-2G clauses 246 and 247 provided guidance about the design of tram windscreens and windows in the UK:
- Clause 246: 'Windscreens and other forward facing windows should be able to resist impact from projectiles or other objects. Other tram windows should conform to the current standards for passenger-carrying vehicles on the highway'.
 - Clause 247: 'It should not be possible or necessary for people to lean out of windows or other apertures or throw large objects through them'.
- 317 In 2006, RSPG-2G was replaced with RSP2. The guidance on windscreens and windows has remained unchanged in RSP2.
- 318 The RAIB commissioned TRL to review the standards applicable to 'passenger-carrying vehicles on the highway' to better understand what standards were applicable at the time the tram was being designed in the mid to late 1990s.

- 319 The Road Vehicles (Construction and Use) Regulations (1986) define the requirement to fit 'safety glass' to the windscreen and windows of all wheeled vehicles first used on or after 1 January 1959. The regulations further define 'safety glass' as a glass 'so constructed or treated that if fractured it does not fly into fragments likely to cause severe cuts'. The regulations identify BS857 alongside United Nations Economic Commission for Europe (UNECE) Regulation 43 as suitable standards to apply for safety glass. For vehicles first used on or after 1 June 1978, the regulations identify BS857 alongside UNECE Regulation 43 as some of the suitable standards to apply for safety glass.
- 320 UNECE Regulation 43 is the current applicable European regulation for safety glazing intended for installation on a wide range of vehicle types including large passenger vehicles. Its requirements match those applicable when the tram was built. This regulation has existed since 1981 but was not the main regulatory document before the introduction of the General Safety Regulation in 2009.
- 321 The types of glazing covered by UNECE Regulation 43 include toughened glass, laminated glass, glass plastics and plastic glazing. UNECE Regulation 43 defines the requirements for each type of glass but does not specify what type of glazing should be used for each type of vehicle application or mandate the thickness of glazing required.
- 322 For toughened glass used in applications others than windscreens, UNECE Regulation 43 defines the following tests to be carried out:
- fragmentation test;
 - 227 g ball impact test;
 - inner face test;
 - humidity test;
 - light transmission test;
 - optional distortion;
 - secondary image;
 - resistance to temperature change;
 - fire resistance; and
 - resistance to chemicals.
- 323 The impact test using a 227 g ball is intended to assess the mechanical strength of the glass. It involves dropping a 38 mm diameter steel ball weighing 227 g from a height of 2 metres above a glass test piece. The test piece is 300 mm x 300 mm and is supported along its edges on a rubber gasket. The impact point is at or near its geometrical centre. The test is repeated on six different test pieces and the tests are deemed to have given a satisfactory result if at least five of the test pieces do not shatter.

324 UNECE Regulation 43 defines a more onerous impact test using a 2.26 kg steel ball with a diameter of 82 mm but this test is specific to windscreens made of laminated glass. It is not applicable to windows made of toughened glass. UNECE Regulation 43 also defines a headform³³ test for windscreens (made of toughened or laminated glass) but this test is aimed at demonstrating that the windscreen will limit head injuries when impacted. It is not used to demonstrate the mechanical strength of the glazing; again, it is not applicable to windows made of toughened glass.

325 In order to understand more about the mechanical strength of toughened glass, the RAIB conducted a series of tests on four intact windows from tram 2551 (the accident tram) and on another set of windows which had recently been removed from another CR4000 tram (both sets of windows were fitted with anti-vandal film, except one door window noted in table 16). The tests were carried out at Horiba MIRA³⁴, a UK-based testing facility for the automotive industry. They used a headform weighing 7 kg, dropped onto the windows from an increasing height, until the windows shattered. These tests were carried out on three types of window (window types 1, 2 and 3) and the headform was dropped in the corner or at the geometrical centre of the window. Figure 46 shows the window test setup.

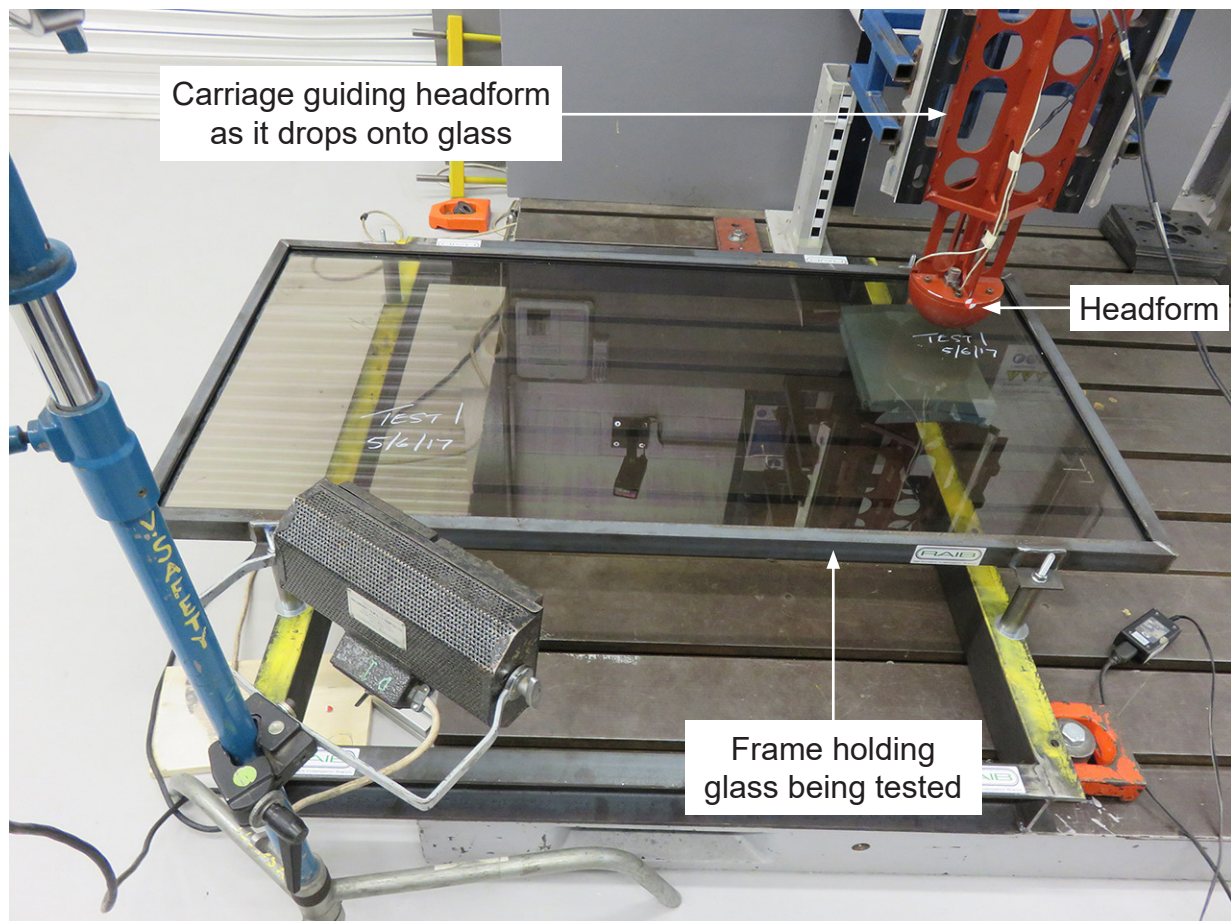

Figure 46: Window testing

³³ The headform is a device shaped as a human head fitted with accelerometers used to study the injuries sustained during impact.

³⁴ www.horiba-mira.com.

326 Table 16 shows the results of the window tests for both tram 2551 and the comparator tram. These show that the bodyside windows would shatter when the headform was dropped from a range of heights varying from 210 mm to 1429 mm (depending on the window size and location of the point of impact). The tests also demonstrated the following:

- a) The drop height required to shatter a window when impacting it in one of its corners is less than the height required at the centre of the window.
- b) Once a window is shattered, it has very little residual strength. This was confirmed because in every test the glass shattered and became completely dislodged with a single impact.
- c) The pair of door window tests showed that the anti-vandal film made no difference to the impact strength of the windows. The only effect of the film in these tests was to keep the broken pieces of glass together once the window had become dislodged.

Window type (see figure 33) and location	Window size	Location of impact	Drop height required to shatter window from the comparator tram	Drop height required to shatter window from the accident tram
Type 1 Bodyside	1000 x 970	Corner	210 mm (1) 328 mm (1) 355 mm (S)	475 mm (S)
		Centre	822 mm (1) 635 mm (1)	572 mm (S)
Type 2 Bodyside	1438 x 750	Corner	822 mm (1) 397 mm (S) 572 mm (S)	442 mm (S)
		Centre	822 mm (1) 1296 mm (S)	1429 mm (S)
Type 3 Door	1690 x 670	Centre (with anti-vandal film)	1296 mm (1)	N/A
		Centre (without anti-vandal film)	1296 mm (S)	N/A

(1) Glass broke on first headform drop (S) Glass did not break when lesser drop used

Table 16: Window impact tests

327 The headform test does not directly replicate most scenarios in which a person would strike a window during a tram accident. A person would be considerably heavier but body deformation would, in many instances, mean that the full body weight was not applied instantaneously to the window. Allowing for both of these effects, the headform tests are considered representative of the loads which could be applied by a body during an accident and so demonstrate that the tram side windows could have been broken by either, or a combination, of the following:

a) Passengers being thrown against the tram windows before the tram hit the ground

The critical heights measured during the tests were for a headform being accelerated by gravity (9.81 m/s^2) towards the window. The study carried out by Bombardier Transportation (paragraph 102) showed that a sustained lateral acceleration exceeding this value was applied to the tram body when the tram was travelling around Sandilands south curve before it derailed.

b) Passengers falling against the tram windows after the tram had hit the ground

Overturning of the tram would have resulted in people falling onto the right-hand side windows even if there was no lateral acceleration. Passengers on the left-hand side of the tram would have fallen the full width of the tram. The drop heights which broke the glass are comparable with or less than the heights from which passengers would have fallen. Even in the unlikely event that a window remained intact after the side of the tram struck the ground (paragraph 329), it could have been shattered by a person dropping onto it.

328 In none of the tests on glass from tram 2551 did a drop height of less than 442 mm cause the glass to break. Since a drop height of 442 mm involved impact energy almost seven times greater than that in a test using a 227 g steel ball, it can be concluded that the glass used in the windows of tram 2551 would meet the impact requirement for toughened glass as detailed in UNECE Regulation 43.

329 The RAIB calculated the change in kinetic energy of a tram window on the right-hand side (in the direction of travel) as the tram overturned and fell on the ground. The calculation demonstrated that the kinetic energy in the vertical direction imparted to a window was much greater than the highest impact energy required to shatter and dislodge windows during the tests. This suggests that all windows would have shattered on impact with the ground where they had not been previously shattered by impacts with passengers. The windows on the left-hand side did not shatter during the impact, probably because of the dampening provided by the elastic deformation of the vehicle body.

330 The RAIB concluded that:

- as the toughened glass fitted to tram 2551 complied with BS857, the tram windows met the requirements of the Road Vehicles (Construction and Use) Regulations 1986; as such the windows were also compliant with RSPG-2G; in addition, the glass is expected to have met the impact requirement for toughened glass as detailed in UNECE Regulation 43;
- the tram windows on the side that contacted the ground could have been shattered by passengers being thrown against them during the overturning, before the tram hit the ground;

- any tram windows on the side that contacted the ground that were not broken during the overturning are expected to have shattered as the tram fell on that side; and
- once shattered, the windows did not have any significant residual strength so as to be able to contain people in the tram.

Toughened glass in other industries

- 331 The fact that toughened glass offers very little resistance to ejection of passengers is well known across the automotive and railway industries.
- 332 In 2006, Cranfield Impact Centre carried out a study for the Department for Transport entitled 'Preventing passenger ejection from buses, coaches and minibuses'. This study report states in its introduction: *'Currently coach, bus and minibus side windows are typically fitted with automotive toughened glass. This is manufactured so that if impacted with sufficient magnitude, it will shatter into blunt fragments that are intended to minimise lacerative injuries. Toughened glass has no residual strength after fracture and would be unable to retain a vehicle occupant who fell against it in this condition.'*
- 333 Similarly, RSSB acting on behalf of the railway industry, conducted a review in 2007 of passenger containment entitled 'A review of research carried out by RSSB on behalf of the rail industry and core recommendations'. This study concluded: *'The toughened glass type of window fitted generally to pre-1994-built vehicles, and fitted as the escape window in more recent vehicles, was subjected to the suite of tests and the absence of any significant level of containment was clearly demonstrated'*.

Doors

- 334 Although meeting relevant design standards, it is also likely that the way the doors were attached to the tram meant that some of the doors were not able to contain passengers when they fell against them during the accident. The post-accident resting position of one passenger, and the fatal injuries that he sustained, suggest that this passenger may have been thrown against, and passed between, the bottom of a door and the vehicle floor (ie the door became detached from the tram). Another two passengers who received serious injuries were found after the accident where a *door leaf* would normally have been.
- 335 There is no specific requirement in RSPG-2G for the structural integrity of doors fitted to trams, or for the doors to be able to contain passengers in the event of an accident. The door supplier stated that the doors had been designed to withstand the structural requirements now found in 'BS EN 14752 - Railway applications, Bodyside entrance systems'. This requires doors to withstand, without permanent deformation, a *proof load* of 1000 N per metre of door opening, applied 1300 mm above the door threshold.
- 336 The RAIB tested undamaged doors from the left-hand side of the tram to understand why doors on the right-hand side had deformed and become detached during the accident. Loads were applied using a ram pushing against doors at either the height specified in BS EN 14752 or at locations approximately matching those where the damaged doors appear to have been struck by people who had been thrown across the tram (figures 47 and 48).

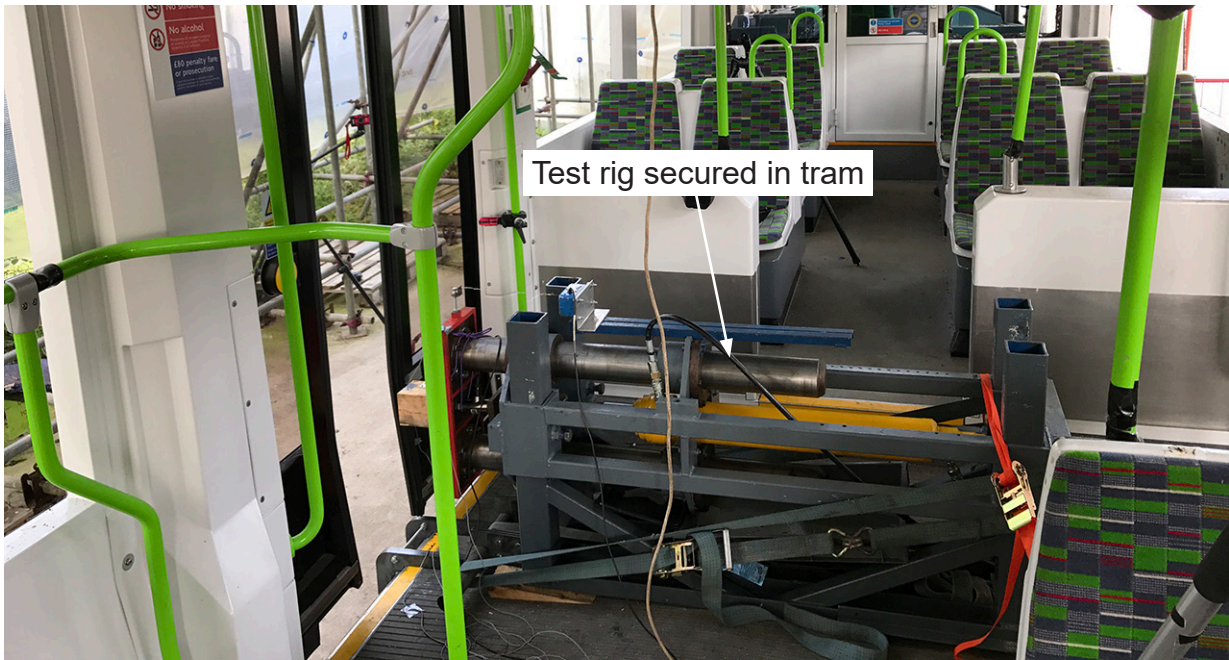

Figure 47: Door test frame

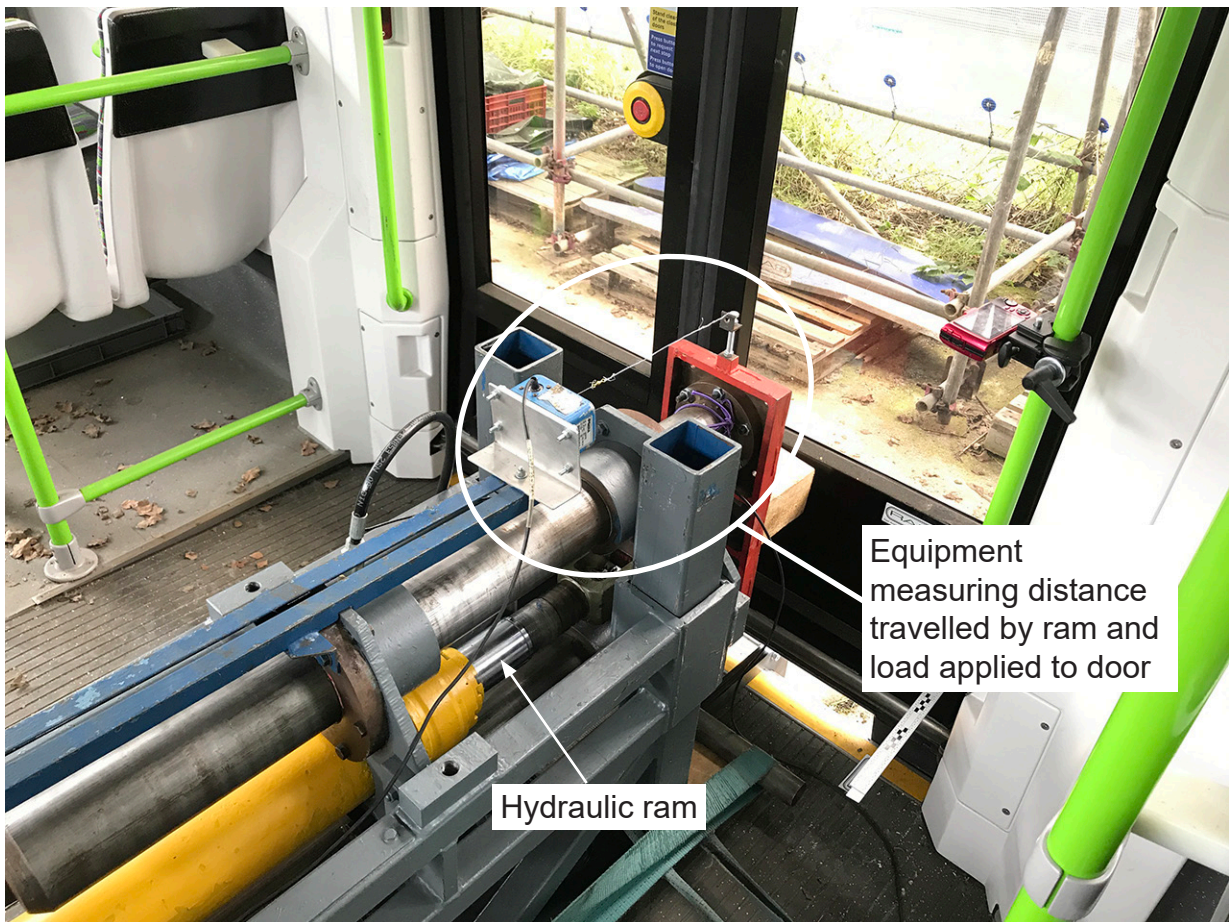

Figure 48: Door test ram and measuring equipment

- 337 In the first test, the proof load specified in BS EN 14752 was applied to one set of doors using a rigid beam mounted at 1300 mm above the door threshold and bearing against the doors' structural members. The doors suffered no permanent deformation and the force required to open the doors after the test, with the emergency release pulled, had not been increased. Hence, the doors were shown to meet the requirement specified in BS EN 14752. In the second test, the proof load specified in BS EN 14752 was multiplied by a factor of 1.5 to represent an ultimate loading condition where permanent deformation is allowed but without catastrophic failure. By the end of this test, the doors had suffered no permanent deformation and the force required to open the doors after the test, with the emergency release pulled, had not increased. In a third test, the door was taken to catastrophic failure (in this case, the rollers becoming disengaged from the retaining channel). This occurred at a load approximately seven times greater than the proof load in BS EN 14752.
- 338 The RAIB tested another two sets of doors with the loads applied at locations approximately matching those where the damaged doors appear to have been struck by people who had been thrown across the tram. These locations were lower than in the previous sets of tests (approximately 450 mm above the door threshold) and concentrated on the inner edge of one door leaf (near to where the door leaves meet when closed). In those tests (figure 49), the hydraulic ram was gradually extended and the displacement and load required to extend the ram were recorded. These tests showed that the load and energy required to force one door leaf open to create a gap large enough for someone to pass between the bottom of the door and the floor was smaller than in the previous sets of tests (to BS EN 14752) and was comparable to the load and energy from an individual passenger being thrown against the door. The RAIB therefore concluded that it was feasible for a passenger to have been ejected through this mechanism.

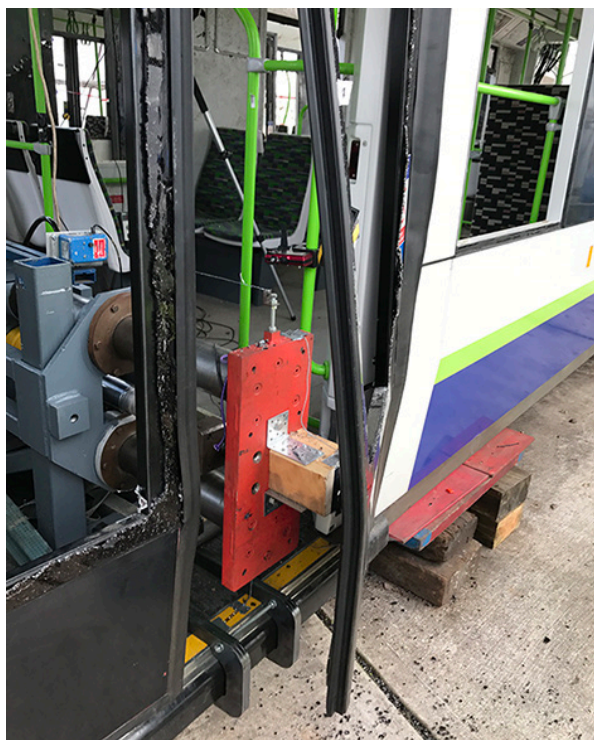

Figure 49: Door deformation due to load applied at level where people appeared to have struck the door

339 During these tests, the failure sequence for the door started with the glass shattering, followed by the corner casting at the top of the inner edge breaking. This was then followed by the failure of the second corner casting in the opposite corner. At that point the bottom of the door leaf was virtually unrestrained and would become detached under minimal additional load. The RAIB noted that these failure mechanisms seemed to be consistent with the failures observed on the right-hand side doors that became detached during the accident.

Body structures

340 The tram vehicle structure was designed to comply with standard VDV152 (paragraph 310) and was also required to meet the requirements of RSPG-2G.

341 VDV152 and RSPG-2G both define the need to design the tram to mitigate against the effects of a collision with another tram, road vehicle or buffer stops. However, none of these documents refer to the possibility that a tram might overturn and hence there are no specific structural requirements covering this eventuality.

342 Although not required to meet specific requirements relating to overturning, the tram body structure performed well during the accident as it maintained its overall shape to preserve the survival space of the passengers and prevented the penetration of external objects.

Interior fixtures

343 There is general guidance in RSPG-2G that the tram interior should be designed to minimise the risk of injuries (clause 266 of RSPG-2G). There is no other specific requirement in RSPG-2G on how to achieve this general objective.

344 Overall, the tram interior appears to have performed reasonably well. The following features limited the extent of passenger injury:

- With the exception of the single seat found fully detached, the furnishings generally stayed attached.
- The edges and corners of the seating and other fittings were designed with generous radii (ie no pointed corners/edges).
- The handrails which were struck by passengers deformed plastically and did not fracture to expose sharp edges.

Evacuation

Emergency lighting

345 The tram's emergency lighting did not work once the tram had overturned.

346 The tram is provided with two rows of fluorescent tubes running along the length of the ceiling and fitted with light diffusers (figure 50). In the event of a loss of supply from the overhead power line, power is provided through roof-mounted batteries, but to a reduced number of tubes which are located around the doorways.



Figure 50: Lighting system

347 As the pantograph lost contact with the overhead power line (paragraph 116), the tram automatically switched to the battery supply for the lighting. The passengers noticed this as a flickering of the lights.

348 As the tram overturned, the lighting system became completely disabled when a safety push-button (figure 51) was operated when the side of the tram came into contact with the ground. This cut off all power supplies, including the one from the batteries³⁵. This push-button is provided to allow the tram to be electrically disabled by the emergency services.

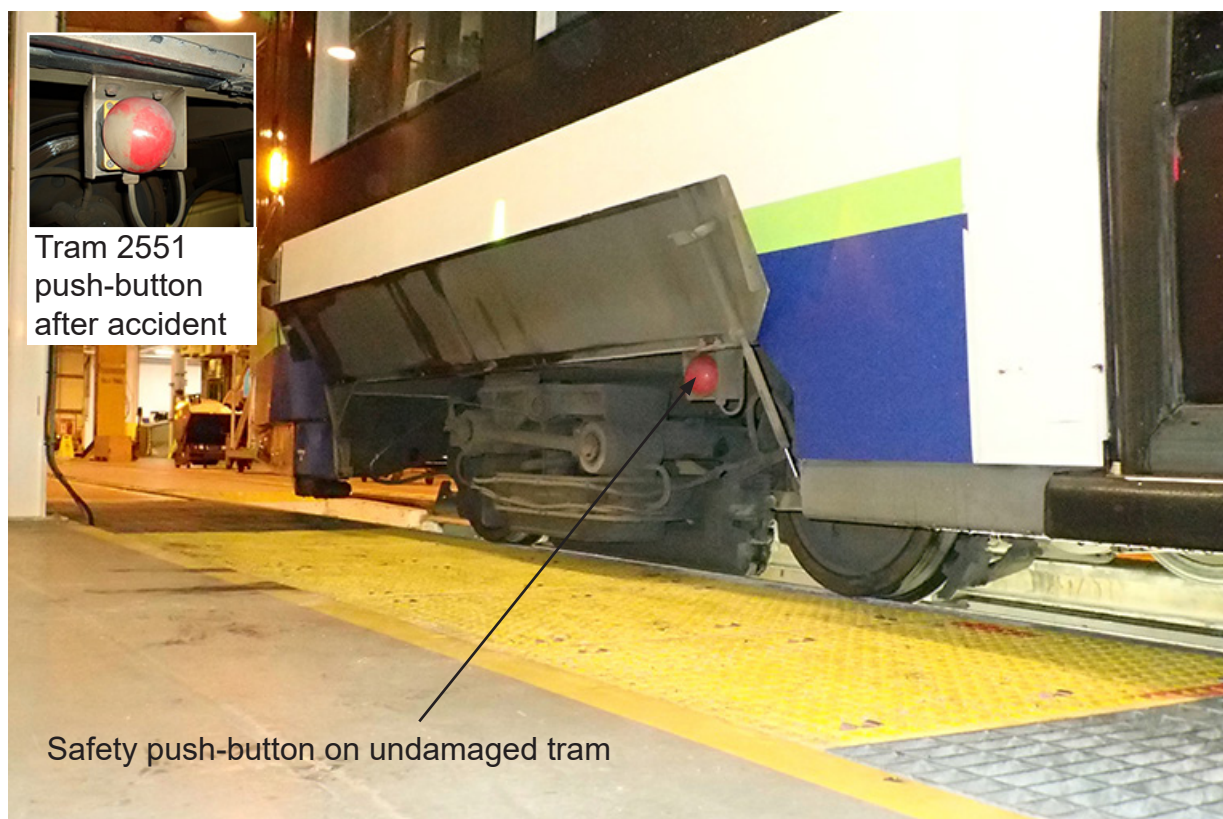

Figure 51: Safety push-button for tram's electrical system

³⁵ All the roof-mounted batteries that supply the lighting system were damaged during the accident but two of the four batteries remained available to power the emergency lights.

349 As a result, the tram was left in darkness which compounded the confusion, shock and distress that the passengers were feeling (paragraph 56).

Emergency egress

350 Passengers' only feasible escape route was through the tram's windscreens.

351 In normal circumstances, the tram had 16 designated egress routes available, all of them through the bodyside doors (a double door counts as two emergency exits). The evacuation strategy in the event of an accident was to use these doors as emergency exits.

352 However, the position of the tram post-accident, with one side resting on the ground, meant that half of the egress routes were physically blocked. The only egress routes available were the four double doors on the left-hand side in the direction of travel, which were now facing upwards, approximately 2.6 metres above the ground.

353 Each door is fitted with an emergency door release handle. Operation of the handle disengages the door driving mechanism and enables the user to manually push the door leaves open. Figure 52 shows the emergency door release handles and identifies the handles that had been pulled after the accident.

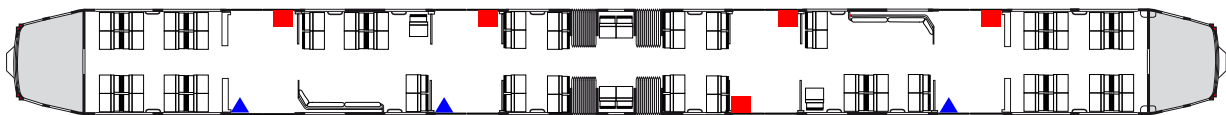

- Emergency door release pulled
- ▲ Emergency door release not pulled

Direction of travel
→



Release pulled



Release not pulled
(normal position in service)

Figure 52: Emergency door release system

354 The position of the tram after the accident meant that the door leaves had to be pushed upwards before they could be moved apart (after operation of the door release handle). This was a difficult operation to complete for the passengers as these doors were above them and they were working at height and against gravity.

- 355 Passengers attempted to open all the double doors on the high side by pulling the emergency door release handles but were only successful in prising the door leaves apart at one location (the leading doors of the trailing vehicle). However, faced with concerns that the overhead line might still be live, the passengers at that doorway decided not to exit the vehicle using that egress route (paragraph 59).
- 356 Some other passengers reported trying to break the windows on the high side to create egress routes but were unsuccessful in doing so.
- 357 Having realised that they needed external help to get out of the overturned tram, many passengers reported a feeling of being trapped. This feeling was compounded by the darkness (paragraph 345).
- 358 Within minutes of the accident taking place, the driver of the accident tram, the driver of tram 2554 and a police officer had created an opening in the front windscreen allowing some of the passengers out (paragraph 62).
- 359 Forty-five people are believed to have left the overturned tram through the hole in the front windscreen. Another sixteen people exited through a similar hole in the rear windscreen which had been made first by Metropolitan Police officers, then made bigger by responders from the London Fire Brigade. Two people had no recollection of which exit they used. However, all survivors got out of the overturned tram through holes made in the front and rear windscreens, which are not designated emergency exits.
- 360 The RAIB has compared the number of emergency exits on the tram with comparable requirements for public service vehicles such as an urban bus as given in UNECE Regulation 107. This regulation defines requirements concerning the approval of vehicles used for the carriage of passengers, including large passenger vehicles, with regard to their general construction. Depending on the passenger loading capacity, the minimum number of exits (including emergency exits) required for a single deck urban bus typically ranges from 6 to 11 exits (11 being required for a single deck articulated bus with a capacity of more than 130 passengers).
- 361 UNECE Regulation 107 allows for an emergency exit to be either a door, a window or an escape hatch. A typical urban bus design will provide sufficient emergency exits using doors, windows and hatches. By comparison, the CR4000 tram with 8 double doors, offers 16 emergency exits through doors and would not need windows as possible emergency exits to comply with Regulation 107. The extent to which exits on a tram or bus are usable following an accident depends on the accident scenario encountered.

Observations

Fatigue risk management (see also addendum to this report)

362 **TOL's management of the risk of tram driver fatigue was not in line with published industry practice in the following areas:**

- rosters and monitoring of rest day working;
- fostering a culture that encourages drivers to report fatigue; and
- providing its drivers with adequate guidance on fatigue management.

363 The RAIB has concluded that the driver's rostered work pattern should not have caused an increased risk of fatigue on the morning of the accident, above the general fatigue risk factor of very early starts (paragraphs 144 to 145). The driver had not worked any overtime or rest days in the 16 weeks before the accident and so this could not be a cause of fatigue. Reporting of fatigue is not relevant to the accident because the accident driver did not believe that he was fatigued (paragraph 148). While there were indicators that the driver's sleep patterns indicated a risk of fatigue (paragraph 150), these indicators were not widely disseminated in the rail industry (although they are found in guidance issued by Network Rail and by Govia Thameslink Railway). The absence of these indicators from guidance issued by TOL to tram drivers does not demonstrate a shortcoming compared to typical industry practice. Although the RAIB has concluded that the working pattern followed by the driver should not have caused an increased risk of fatigue on the morning of the accident, the RAIB's investigation has identified areas where TOL could improve management of these issues.

TOL processes

364 TOL manages the risk of fatigue primarily through procedure SM003 'Safety critical employees – management of fatigue'. Procedure SM003 says that TOL is committed to 'providing reasonable roster patterns that are designed to reduce fatigue' and 'providing opportunity for employees to obtain adequate rest from work'. Procedure SM003 states that TOL will adopt fatigue management practices including the:

- use of a forward rotation roster system (booking on later rather than earlier on successive shifts);
- design of rosters so that there is an adequate recovery period to eat, rest and sleep prior to the next duty;
- provision of sufficient resources to meet rostered duties without the need for regular overtime working; and
- provision of information to employees on the risks of fatigue including issues such as the effect of travel distances (travelling to work), voluntary work and lifestyle.

365 Procedure SM003 says that employees are expected to:

- make appropriate use of off-duty periods provided in the working pattern to obtain sufficient sleep to carry out their work safely, including taking future duty times into account when planning their off-duty lives;

- take reasonable steps to ensure that their sleeping environment, nutrition, use of caffeine, alcohol, drugs and medications, and their travel arrangements do not adversely affect their ability to carry out their duties safely; and
- inform their manager as soon as possible if they believe that they or a colleague are, or are likely to become, too tired to carry out their duties safely.

366 The base roster is designed around the requirements of the tramway timetable provided by TfL, consideration of fatigue issues, and the requirements of terms and conditions negotiated with the tram drivers' trade union representatives. Additionally, TOL provides 'special' rosters for those who prefer to work on 'early' or 'late' shifts to accommodate flexible working arrangements.

Roster and rest day working

367 Tram drivers generally work through a roster comprising 98 consecutive weeks. All the rosters incorporate blocks of work days separated by rest days. Weekends form part of the working week. The roster operates on the basic principles of a maximum shift length of 12 hours, a minimum rest between duties of 12 hours, maximum hours worked in any 7 day period not to exceed 72 hours, and no more than 12 work duties in any 14 day period. During a work day, each driving duty must incorporate a break of at least 30 minutes which should normally take place no later than 5 hours 30 minutes from beginning duty. Whilst such working time limits are seen as insufficient protection against fatigue in the context of current published good practice, many of the normal TOL tram driver rosters fell well within this published practice.

368 TOL's delivery of the timetable is based on a total of 686 duties (tram driver shifts) which are assigned to drivers through a roster system. The RAIB has analysed the duties to identify potential fatigue factors that are described in ORR's guidance on managing rail staff fatigue. The majority of the duties (465 out of 686) had no fatigue factors associated with them. Among the remaining duties, the most common ORR fatigue factors were:

- Early starts between 05:00 hrs and 07:00 hrs: 11.8% of all roster duties.
- More than 55 hours worked in a seven day period: 6.3% of all roster duties.
- Very early starts (before 05:00 hrs): 6.1% of all roster duties.
- Backward rotation (where shifts start at least one hour earlier the next day): 5.2% of all roster duties.
- Less than two days rest after a block of consecutive early starts: 4.7% of all roster duties.

369 The most common fatigue factor in these duties, excluding those due to the unavoidable need to start some duties before 07:00 hrs, is that 6.3% of duties involve working more than 55 hours in a seven day period. This is a possible factor in the incidents described at paragraphs 376 and 377. In addition to factors associated with individual duties, one of the most significant fatigue factors in TOL rostering is allocating drivers a week of similar shifts and then a significant change in working hours. This is recognised as a fatigue factor in ORR guidance because, after a week, a person's body clock is just starting to adapt to a shift pattern. This is considered to be worse than a much shorter rotation, because it is associated with maximum build-up of sleep debt without the benefit of adapting one's body clock.

370 The base roster, and so the analysis at paragraph 368, does not include overtime or rest day working. The RAIB therefore also reviewed samples of drivers' timesheets for four-week periods from before and after the accident on 9 November 2016. The review found that a substantial proportion of drivers (42% before the accident; 33% after the accident) worked at least one rest day in the four-week period, with some drivers working up to four rest days in total across a four week period. In many cases, the worked rest day was before or after a run of seven consecutive shifts, and in some cases worked rest days resulted in up to 12 consecutive shifts (up to 96 hrs) being worked.

371 TOL told the RAIB that rest day working:

'Has always been a means of catering for sickness, absence, holiday changes and facilitating engineering works. Whilst it is likely to continue to meet this need the demand is not constant. Rest day working is voluntary. We always have enough volunteers as the requirement is not significant. Whilst this overtime is a necessary resource to provide flexibility it is not something which we rely on daily to provide the service. We never routinely schedule overtime or work rest days as part of the roster.'

372 The RAIB driver questionnaire (paragraph 91) showed that 48 of the 59 respondents (81%) found the roster to be 'somewhat' or 'definitely' a cause of fatigue³⁶. Further analysis showed that the predominant concerns were: working seven consecutive days, transitions between late and early shifts, very early starts, very late finishes and split rest days (eg finishing work in the early hours of the morning following a run of late turns, having one rest day then being back at work the next day at around 04:00 hrs for a run of early turns). The RAIB's analysis of the roster and timesheets found that split rest days were exclusively associated with rest day working, and did not appear on the base roster.

Fatigue reporting and identification

373 Of the 59 Croydon tram drivers who returned the RAIB's driver questionnaire, eight said that they had reported being unfit to work because they were tired (although the source of their fatigue was not recorded on the questionnaire). Of these, one driver responded that they feigned illness rather than saying they were tired and another responded that following his report of being unable to continue because he was tired, he was 'berated' for it and comments were made about him by some line controllers (this may reflect a wider issue relating to TOL's overall approach to incident reporting discussed at paragraphs 224 to 231). Six drivers responded to the questionnaire saying that they were unaware that fatigue could be reported.

374 TOL has reported that, between 1 January 2012 and the day of the Sandilands accident, its own staff identified 13 instances of tram drivers being fatigued or inattentive. During the same period, TOL reported that it received no public complaints relating to tram driver fatigue or inattentiveness.

375 The RAIB has considered five widely reported events on the Croydon tramway to establish whether fatigue due to rostering and/or rest day working was a possible factor. These events are listed in table 17. From the evidence available to the RAIB, it is possible that fatigue was a contributing factor in two of the five instances where these drivers had worked a high number of consecutive shifts.

³⁶ Possible influences on questionnaire responses are described at paragraph 91.

Incident	Consecutive duties (days)	Rest since last duty (hrs:mins)	Fatigue a contributing factor?
Tram overshooting George Street tram stop on 8 January 2005	5	16:18	No evidence of fatigue from duty hours
Tram passing a signal showing stop and a subsequent conflicting tram movement at Avenue Road on 15 March 2011	2	17:00	No evidence of fatigue from duty hours
A buffer stop collision at Elmers End on 23 November 2013	2	16:27	No evidence of fatigue from duty hours
Driver filmed apparently asleep at the controls of a tram travelling between Coombe Lane and Gravel Hill on 21 April 2016	7	15:50	Possibly (paragraph 376)
Driver filmed apparently asleep at the controls of a stationary tram at a road junction at George Street on 17 May 2017	9	14:11	Possibly (paragraph 377)

Table 17: Review of fatigue of drivers in previous incidents

376 A driver was filmed apparently sleeping on 21 April 2016 at about 18:00 hrs while travelling between Coombe Lane and Gravel Hill. The RAIB found that the day of the event was the last in a block of seven late shifts totalling more than 55 hours. The driver had only had two (separate) days' rest in the 13 days leading up to the incident. The driver stated that he had not fallen asleep.

377 A different tram driver was filmed apparently asleep at the controls of a stationary tram at a road junction near George Street in Croydon at about 08:00 hrs on 17 May 2017. The driver was on his ninth consecutive shift, having worked his rest days before and after the seven consecutive work days in the base roster.

378 The first of these events involved a run of shifts totalling more than 55 hours in seven days, a fatigue factor noted in ORR guidance (paragraph 368). Both events involved seven or more successive shifts and this is a possible cause of fatigue as 26 of the 59 drivers (44%) responding to the RAIB questionnaire reported that a shift pattern including seven successive shifts caused fatigue.

379 In response to the RAIB's questionnaire (paragraph 91), 38 of the 59 tram drivers who responded (64%) said they had felt fatigued while driving a tram with four mentioning experiencing loss of concentration and bearing, and three mentioning having either fallen asleep, or experiencing a microsleep.

Guidance on individual management of fatigue

380 It is important that drivers properly prepare themselves for safety-critical work, particularly when trying to balance personal, family and work commitments around shift working. For example, it can be difficult to go to bed and sleep in the early evening at the expense of family time or personal hobbies and interests. On occasion people may trade-off sleeping time for these other commitments.

381 TOL stated that its initial driver training includes a session on how to manage lifestyle while shift working. After this initial training, the information is not routinely repeated or reinforced, but occasional fatigue briefings have taken place. Unlike some other industries, including other parts of FirstGroup working within the rail sector, TOL does not issue guidance to its drivers about managing life away from work.

382 RAIB's driver questionnaire asked tram drivers if they had ever experienced issues managing their own fatigue; for example, balancing their home life and work life. The results showed that 29 of the 59 respondents (49%) had experienced fatigue while driving, either somewhat or definitely as a result of managing the balance between home life and work. Forty-four drivers (75%) responded that they thought TOL's fatigue management (including briefings and guidance about fatigue) was 'poor' or 'very poor'.

Adherence to speed limits

383 Although there is evidence of some tram drivers sometimes exceeding the speed limit, generally by small amounts, there is no evidence that a speeding culture contributed to the accident.

384 The RAIB has considered both tram speeds obtained from signal loop data (paragraph 18), and TOL's monitoring of tram speeds, and concluded that there is no evidence that a culture of speeding contributed to the accident on 9 November 2016. Permitted speeds take account of passenger comfort and the need to avoid injuries caused by passengers being thrown across trams. The significant difference between these speeds and the speeds needed to cause a tram to overturn can mean that legitimate complaints about tram speeds on curves are not necessarily an indication of tram speeds likely to cause overturning.

Tram speeds from loop data

385 The RAIB has analysed loop data to determine whether there was evidence that the driver involved in the accident, or other drivers, had previously approached Sandilands south curve at excessive speed.

386 Loop data from 1 January 2015 to 21 December 2016 was analysed for pairs of loops on the Sandilands curves. This includes almost all tram transits in this period (a small proportion, less than 10%, were not analysed for reasons explained in Appendix D). Each loop pair is either the approach to a speed restriction plus part of that restriction or entirely within a speed restriction. The RAIB has calculated the maximum permitted average speed between each loop pair taking account of the higher speed permitted in the first part of some loop pairs (figure 53).

387 The times recorded to traverse the distance between the loop pairs are subject to some uncertainties, so the time recorded for a tram to pass between a pair of loops is associated with a range of possible average speeds for reasons explained in Appendix D. Paragraph D8 explains why a small proportion of trams may have travelled at speeds slightly outside the ranges given in this report.

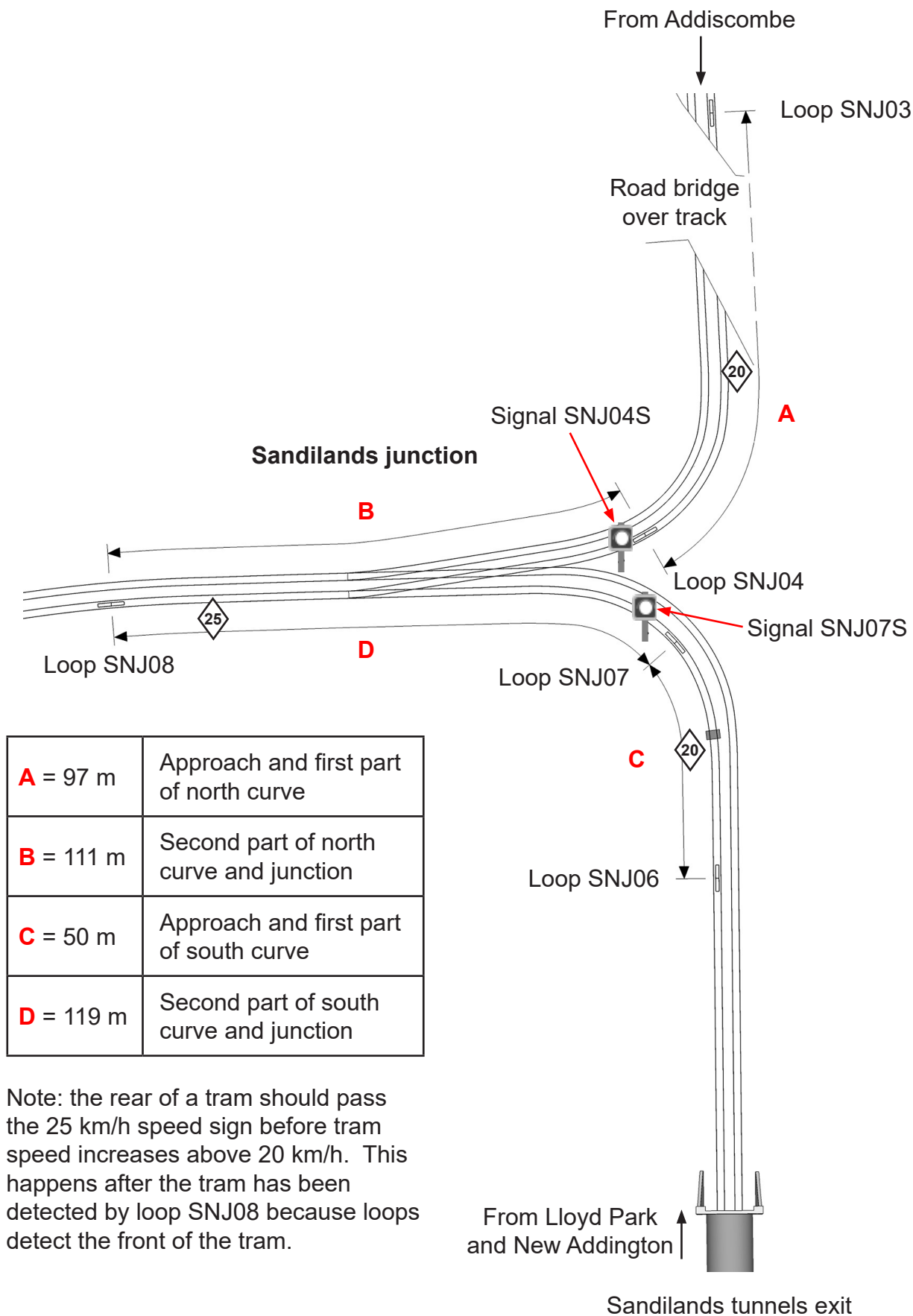

Figure 53: Position of loops used in the RAIB analysis

- 388 Drivers are identified using a driver identification number which they are required to enter using a keypad in the cab when taking over a tram. This may be inaccurate if, for example, a driver forgets to enter their number and their actions are then assigned to the previous driver.
- 389 It is important to note that a speed recorded as slightly in excess of the permitted value does not indicate a 'speeding' driver. When conducting speed checks, TOL accepts that drivers may be travelling slightly above the permitted speed, for reasons including inaccuracies in speedometers and the challenge of maintaining a precise speed while looking for obstructions on the line ahead. For these reasons, TOL accepts that trams may be travelling at up to 3 km/h above the permitted speed. This allowance is not dissimilar to allowances made by other tramways and by organisations enforcing speed limits for other vehicles on the public highway.
- 390 The loop data has been used to assess tram speeds on the inbound line approaching Sandilands south curve and the first part of this curve. The first of the loops used for this assessment is before the 20 km/h speed sign and the second is after the sign. As trams can travel at more than 20 km/h (12 mph) until they reach the sign, the RAIB has calculated a maximum average permitted speed between the loops assuming full service braking is applied between the loop and the sign (ie a tram passes the first loop at 36 km/h (22 mph), reaches 20 km/h (12 mph) as it arrives at the sign, and continues at this speed until reaching the second loop).
- 391 The data in table 18 shows that tram 2551 (the accident tram) and the tram on 31 October 2016 (paragraph 180) both travelled at a substantially faster speed than all other transits on the approach to, and first part of, the south curve. Only 116 (about 0.1%) of the other transits exceeded the permitted speed and, with one possible exception, none did so by more than 7 km/h (4 mph). None of these transits were made by the driver involved in the accident on 9 November 2016 or by the driver involved in the incident on 31 October 2016. None of these transits involved speeds close to 50 km/h (31 mph) at which overturning was likely to occur (table 6)³⁷.
- 392 The RAIB has not identified a change in circumstances which would explain why the two very fast transits occurred in a 10-day period after a period of at least 22 months (ie since the start of the data analysed by the RAIB) with no similar events. Some environmental changes (eg seasonal vegetation changes) would have taken place within the 22-month period but there is no evidence of a major change to the infrastructure.

³⁷ Passenger loading, rail-wheel adhesion and other parameters can vary between transits and affect the minimum speed at which tram overturning occurs. These have a small effect on the overturning speeds given in table 6, but are not sufficient to affect the conclusion above.

Recorded time between loops (seconds)	Likely speed range (km/h)	Number of transits	Notes
2	>60	1	Accident transit known to be approximately 73 km/h
3	>45	1	Transit on 31 October 2016 (paragraph 180)
4 & 5	No transits recorded		
6	26-36	1	Transit at average speed between 3 km/h and 13 km/h above the maximum permitted average of 23.5 km/h
7	23-30	116	0.1% of all transits at an average speed up to 7 km/h above the maximum permitted average of 23.5 km/h
8	20-26	3726	4.2% of all transits at approximately maximum permitted average speed of 23.5 km/h
9-20	8-23	84447	95.7% all transits at an average speed less than maximum permitted average of 23.5 km/h
Total number of transits analysed		88292	

Table 18: Tram speeds on approach to, and on first part of, Sandilands inbound south curve (accident location)

393 The RAIB is aware of passenger reports that trams were speeding at Sandilands before the day of the accident. The RAIB therefore analysed transit data for the second part of the inbound south curve and the section of track immediately after this (table 19). The tram is within the 20 km/h (12 mph) area when passing the first loop used for this analysis and the rear of the tram is still in this area when the tram is recorded as passing second loop. Therefore, a tram should not exceed the maximum permitted speed of 20 km/h (12 mph) throughout this period. The analyses shows 39% of trams exceeding the permitted speed, but generally by only a small amount. Given speeds recorded on the approach to the curve, it is likely that most trams exceeding the limit have started to accelerate before reaching the end of the speed restriction, possibly after tram drivers see signal SNJ 07S change from a stop aspect to a proceed aspect while their tram is on the curve.

Recorded time between loops (seconds)	Likely speed range (km/h)	Number of transits	Notes
13	31-36	5	3.8% of all transits at an average speed up to 16 km/h above the 20 km/h maximum permitted
14	29-33	73	
15-17	24-31	3175	
18-20	21-25	30294	35.3% of all transits at an average speed up to 5 km/h above the 20 km/h maximum permitted
21-22	19-22	31527	36.7% of all transits at approximately the permitted average speed of 20 km/h
23-30	14-20	20757	24.2% all transits below maximum permitted speed of 20 km/h
Total number of transits analysed		85831	The number of transits does not exactly match that in table 18 for reasons explained in Appendix D (paragraph D3)

Table 19: Tram speeds on second part of Sandilands inbound south curve

394 Analysis of data for the north curve (tables 20 and 21) shows similarities with the south curve except that there are no very high speed transits similar to the events on 31 October 2016 and 9 November 2016. About 2.6% of recorded times show trams travelling in excess of the permitted speed on the entry to the curve, but almost all of these travelled at no more than 5 km/h above the permitted speed. The fastest transits, between 4 km/h (2 mph) and 10 km/h (6 mph) above the permitted speed, were recorded by only 0.02% of trams. As for the south curve, the first loop on the approach is before the 20 km/h sign so an average speed exceeding 20 km/h (12 mph) is permitted but the 20 km/h (12 mph) limit does apply for the analysis applicable to the second part of the curve.

Recorded time between loops (seconds)	Likely speed range (km/h)	Number of transits	Notes
11	29-35	26	0.02% of all transits at an average speed between 4 km/h and 10 km/h above the maximum permitted of 25.5 km/h
12	27-32	403	0.3% of all transits at an average speed between 2 km/h and 5 km/h above the maximum permitted of 25.5 km/h
13	25-29	3310	2.4% of all transits at an average speed up to 4 km/h above the maximum permitted average of 25.5 km/h
14	23-27	11149	8.0% of all transits at approximately the maximum permitted average speed of 25.5 km/h
15-23	15-25	125092	89.3% of all transits below the maximum permitted average speed of 25.5 km/h
Total number of transits analysed		139980	

Table 20: Tram speeds on the approach to, and first part of, Sandilands inbound north curve

Recorded time between loops (seconds)	Likely speed range (km/h)	Number of transits	Notes
12	31-36	3	0.002% of all transits at an average speed between 11 km/h and 16 km/h above the permitted speed of 20 km/h
13	28-33	59	0.04% of all transits at an average speed between 8 km/h and 13 km/h above the permitted speed of 20 km/h
14-16	23-31	3637	2.5 % of all transits at an average speed between 3 km/h and 11 km/h above the permitted speed of 20 km/h
17-18	21-25	22486	15.8% of all transits at an average speed up to 5 km/h above the permitted speed of 20 km/h
19-20	19-22	52622	37.1% of all transits at approximately the permitted speed of 20 km/h
21-36	11-20	63031	44.4% all transits below the maximum permitted speed of 20 km/h
Total number of transits analysed		141838	The number of transits does not exactly match that in table 20 for reasons explained in Appendix D (paragraph D3)

Table 21: Tram speeds on second part of Sandilands inbound north curve

395 As with the south curve, a significant proportion, about 18%, of transits exit the curve in excess of the permitted speed, but most do so by a relatively small margin (15.8% of transits are less than 5 km/h (3 mph) in excess of the permitted speed). Only three transits (0.002% of all transits) were between 11 km/h (7 mph) and 16 km/h (10 mph) above the permitted speed.

396 The loop data provides no evidence of trams travelling around the Sandilands curves at speeds close to those where overturning is a risk before the events on 31 October 2016 and 9 November 2016. A small proportion of trams accelerated while on the curve to reach speeds which are consistent with public reports of trams travelling fast around corners. Comparison with the data in table 6 shows that none of these recorded speeds were likely to result in a tram overturning but some would result in passengers being pushed towards the side of the tram³⁸.

TOL's tram speed monitoring

397 TOL reported that, before the Sandilands accident, it used covert monitoring (riding in the rear driving cabs of trams during assessments) and a radar speed gun, similar to that used by road traffic police, to check the speed of trams. This was in line with typical practice in the UK tramway industry before the Sandilands accident. An RAIB questionnaire completed by the main tramway operators (listed in paragraph 66) asked for details of tram speed monitoring. In addition to Croydon, only one other UK tramway reported use of a radar gun or similar speed measuring device. Several others used covert monitoring (ie riding in a tram without the driver's knowledge) to check compliance with speed limits.

³⁸ Passenger loading, rail-wheel adhesion and other parameters can vary between transits and affect the minimum speed at which tram overturning occurs. These have a small effect on the overturning speeds given in table 6, but are not sufficient to affect the conclusion above.

- 398 Use of OTDR data for routine checking of tram speeds had been trialled by one tramway but was found to be impractical for routine compliance checks. TOL did not use OTDR information for reasons given at paragraph 83. Use of radar speed guns was commonplace on the UK main line railway, but in recent years OTDR has been more widely used for speed monitoring instead.
- 399 Before the Sandilands accident, TOL reports that it carried out radar speed checks at four-weekly intervals at locations chosen by the operations manager. The locations chosen were generally where it was believed the worst consequences from speeding may occur; for example, striking pedestrians using foot crossings, derailing through points at junctions, or derailing at locations where the permitted speed had been temporarily reduced because of track irregularities. About one-sixth of these radar speed checks were undertaken on curves.
- 400 RAIB reviewed TOL's speed check records for the three-year period from 2014 to 2016 and found that generally they had been completed at four-weekly intervals. However, 5 of the 34 months sought by the RAIB could not be found by TOL. Available records for the years 2014 to 2016 showed that 474 radar speed checks had been undertaken and seven drivers had been exceeding the permitted speed by more than 3 km/h. The highest recorded overspeed was by 9 km/h, on a tram travelling between Sandilands and Addiscombe on the route to Beckenham Junction/Elmers End in August 2014.

Detection of driver awareness

401 In common with most trams and trains in the world, there was no device fitted that was capable of reliably detecting drivers' loss of awareness.

- 402 The DSD (colloquially known as the 'dead man's handle', paragraphs 34 and 36) is intended to stop the tram if the driver becomes incapacitated and no longer applies downward pressure on the TBC. It will stop the tram (unless the driver reapplies pressure during a period of 4 seconds when an audible warning sounds) if, for example, illness causes the driver to become unconscious and then to fall from their seat. The DSD is not designed to stop the tram if the driver ceases to be vigilant, but still maintains downward pressure on the TBC. In some instances the weight of a person's arm may be sufficient to achieve this.
- 403 When tested after the accident, the DSD system fitted to tram 2551 was found to be functioning correctly and there was no evidence that it had been deliberately disabled. As such, it is apparent that the driver of tram 2551 maintained downward pressure on the TBC although he had lost awareness of the driving task as he approached Sandilands south curve on the day of the accident.
- 404 The RAIB has considered whether the widely reported incidents summarised in table 17 (paragraph 375) should have been prevented by the trams' DSDs and/or vigilance devices. It is feasible that all could have occurred while the driver maintained downward pressure on the TBC. The DSD would not have operated during the incident on 17 May 2017 because the tram was stationary.

- 405 The RAIB has not been able to determine if the DSD was defective on the trams involved in these incidents because none were tested. This was consistent with LT procedures which only required a test if a driver alleged a DSD failure, and no such reports were made when the incidents occurred. Between 2011 and 2016 LT's records show there were eight reported failures of the DSD for the CR4000 fleet: three in 2011, one in 2012, two in 2013, one in 2015 and one in 2016³⁹. Of these reported failures, LT stated that on five occasions no fault was found with the DSD system.
- 406 Since the accident at Sandilands, LT has introduced maintenance work instruction W15601 'Testing the driver's safety device on CR4000 trams'. This instruction requires that the force needed to hold the TBC down, and thus engage the DSD system, should be between 5.5 N and 8.5 N, and that when the TBC is not held down the DSD system alarm should sound and the tram's brakes should apply. Since this work instruction was introduced there have been six DSD failures found during scheduled examinations where the required pressure to hold down the TBC was lower than specified (ie less than 5.5 N). There were no reported instances of the tram brakes failing to apply when the holding force was removed from the DSD.
- 407 There have been a number of accidents over the last 35 years where a train driver has lost attention or become incapacitated, but the DSD system fitted to a main line train has not operated. These include the following accidents:
- Bronx, New York USA⁴⁰, in 2013 when a train overturned around a curve. It was reported that the driver had fallen asleep. The DSD system was tested following the accident and found to be working correctly.
 - Waterfall, Australia, in 2003⁴¹ when a train overturned around a curve. It is believed the driver suffered a heart attack, but the weight of his legs was sufficient to hold the DSD foot pedal in the required position.
 - Paddington, London, in 1983⁴² when a train derailed on a set of points having approached them at excessive speed. The investigation identified that the DSD pedal could be kept pressed down by an unconscious driver.

The tram's CCTV system

408 The CCTV recording system fitted to tram 2551 was not recording.

409 Croydon trams are fitted with CCTV cameras facing ahead of the tram, behind the tram and within the tram's passenger saloon. CCTV is provided for security purposes and recorded images can also aid in the investigation of accidents and incidents (paragraph 184). The equipment is intended to record images from all these cameras and to display live images from the rear facing camera so the driver can see if anyone is holding onto the back of the tram ('surfing').

³⁹ The RAIB is aware of a DSD defect affecting the Stadler trams when first used on the Croydon network but this is not relevant to the Bombardier CR4000 trams involved in the incidents considered in this report.

⁴⁰ Report available from www.nts.gov.

⁴¹ Special Commission of Inquiry report available from <https://www.onrsr.com.au/resource-centre-document-finder/waterfall-rail-accident>.

⁴² Report available from www.railwaysarchive.co.uk.

- 410 No recordings relevant to the accident were available from the CCTV fitted to tram 2551 because the system's digital video recorder (DVR) unit was not functioning. This has affected the RAIB's analysis of the cause of injuries and fatalities because the absence of CCTV images has meant that the RAIB cannot identify the positions of some of the passengers in the tram with certainty, immediately before it overturned.
- 411 Trams are not prevented from entering service if they have a defective CCTV recorder (although images displayed on the driver's monitor to see if anyone is surfing are required). LT procedure LT-IMS-DEPOT-070 'Restricted use of trams with isolated or defective equipment' does not include CCTV systems in the list of equipment that prevents a tram entering service, or remaining in service if it is or becomes defective. This is similar to the trains that operate on the UK main line rail network where CCTV systems are not designated as 'safety-critical'. The RAIB notes that there is likely to be a general expectation among passengers that the installed CCTV equipment will be working for reasons of safety and crime prevention.
- 412 TOL procedure OP0045 'CCTV/Audio recording — control and management of equipment' includes the arrangements for the management of CCTV and audio recording systems. With regard to the CCTV systems fitted to trams, the procedure says that the duty manager will check tram CCTV recordings at night to identify that the CCTV system is in working order. In this way the CCTV equipment of all of the trams is checked once per four-week period. These checks are recorded on a form and the details of any CCTV faults are logged to be followed-up by LT technical staff.
- 413 TOL's records of tram 2551 CCTV inspections from January 2016 until the time of the accident (table 22) show that the CCTV DVR was last reported to be recording correctly when it was checked on 31 July 2016. When next checked, on 23 August 2016, it was found not to be recording.
- 414 The next check, on 25 September 2016 appears to have been undertaken as part of an investigation into a fault with a camera. The record of this check did not comment on whether images were being recorded by the DVR or not. However, an examination of the hard disk removed from the DVR following the accident found that it contained recordings from another tram dating from 24 September. This suggests that a previous hard disk was removed from the recorder on 25 September and this may indicate that a check of recording function was undertaken, but that it was not documented. The final check undertaken prior to the accident on 21 October 2016 again found that the DVR was not recording.

Time period within which one check is required on each tram	Date tram 2551 CCTV checked	Tram 2551 CCTV status
10 January 2016 to 6 February 2016	12 January 2016	Recording
7 February 2016 to 5 March 2016	22 February 2016	Recording
6 March 2016 to 31 March 2016	No record of a periodic check	
1 April 2016 to 28 April 2016	30 April 2016	CCTV disc contained only two days of recordings
29 April 2016 to 28 May 2016	Not checked	Not known
29 May 2016 to 25 June 2016	Not checked	Not known
26 June 2016 to 23 July 2016	12 July 2016	Not recording
24 July 2016 to 20 August 2016	31 July 2016	Recording
21 August 2016 to 17 September 2016	23 August 2016	Not recording
18 September 2016 to 15 October 2016	25 September 2016	Check undertaken after a report of a malfunction with a camera. Not clear if recording or not.
16 October 2016 to 12 November 2016	21 October 2016	Not recording

Table 22: Tram 2551 CCTV checks

- 415 The recording faults noted in August and October 2016 were recorded on LT's maintenance system. However, LT stated that the report made in August did not include sufficient information to allow the fault to be repaired and so no action was taken (a tram identification number was not entered on the fault report). LT also stated that there were problems with the way the October report was made, and that the resulting confusion about which maintenance team was responsible meant that this report was again not actioned.
- 416 The CCTV DVR unit removed from the tram following the accident was examined by the original manufacturer. It was found to be non-functional because a hard disk cable assembly had been damaged and the repair to it had not been completed in accordance with the manufacturer's specification.
- 417 The RAIB was able to determine that the DVR unit had been overhauled by an external supplier and then returned to LT for testing in December 2015. Documents provided by the supplier suggest that the overhaul of the DVR had not required the hard disk cable assembly to be removed or repaired. From the documents made available by LT, it has not been possible to determine how the DVR unit was tested by LT following this overhaul and when it was subsequently fitted to tram 2551.
- 418 In November 2012 LT identified the need to upgrade the CCTV system fitted to its CR4000 trams. During 2013 and 2014 LT approved the trial fitment of new CCTV digital video recorders to CR4000 trams and trials began in 2015 with new digital video recorders fitted to four of the CR4000 trams.

- 419 In November 2015 LT produced the project requirements and supporting procurement strategy for the fitment of new digital video recorders on all CR4000 trams. The strategy and funding requirements were reviewed at a meeting on 20 April 2016 when the estimated project completion date was May 2017. At a meeting on 26 June 2016 it was reported that the CCTV project had been re-phased to commence in financial period 10 (the period from 11 December 2016 to 9 January 2017) to align with available funds for the years 2016/17 to 2017/18.
- 420 At a meeting on 23 July 2016 it was reported that the LT executive committee had requested that the CCTV project commence as soon as possible. A draft project requirement document had been produced and issued within LT for comment. The project team had commenced a review of the delivery programme. However, at a meeting on 20 August 2016 it was noted that a decision had been made to replace the CCTV digital video recorders and monitors, but not the CCTV cameras.
- 421 A contract for upgrading the tram CCTV system was awarded on 29 November 2016 and the first new CCTV equipment was fitted to a tram on 6 March 2017.

Tram maintenance instructions

422 Some of LT's vehicle maintenance instructions were not up to date.

- 423 During the investigation, the RAIB found instances of maintenance instruction documentation which no longer matched the maintenance being performed on the CR4000 fleet of trams. The maintenance needs had changed from those specified by the manufacturer when the trams first became operational. Changes to rolling stock maintenance processes are common as operational experience is gained and technical modifications are made during a vehicle's lifespan.
- 424 The RAIB observed that, in instances where documented instructions were out of date, maintenance tasks were undertaken based on staff knowledge and experience. However, it is important that documentation is kept up to date so that new staff, and staff carrying out rarely performed tasks, have a reliable source of information.
- 425 Out of date instructions seen by the RAIB included the following:
- Bogie centre pivot – maintenance instructions (document reference UX102a) refer to metal pivot bushing, which had been replaced by a composite bushing with different examination and removal requirements.
 - Load sensor function – testing results outside the range specified within the maintenance instruction (ref. EH101) were considered acceptable by LT based on operating experience.
 - Oil sampling – sample taking instructions (ref. TG102 (W15442)) were complete but there was no corresponding instruction for analysis of the samples.

Safety cooperation and standard setting

426 **UK tramways did not have a mechanism to promote effective sharing of safety information or the development of common approaches to the management of risk.**

- 427 The response to both the urgent safety advice issued by the RAIB following the accident at Sandilands, and questionnaires sent to UK tramways, indicated that the risk associated with overturning on curves was not generally appreciated. As such, this accident could have occurred on other UK tramways.
- 428 Previous RAIB investigations have found that there is an absence of reliable consolidated data concerning incidents and accidents on UK tramways. Each tramway has its own systems for collecting data but this data is not effectively shared between operators.
- 429 RAIB's report into a fatal accident in Piccadilly Gardens, Manchester on 5 June 2011 included a recommendation that 'UK tram operators should work together to improve the data collection on tram front end collisions with pedestrians'. The RAIB has since been informed that a database is being developed to enable such data collection and the sharing of operational experience. However, progress is slow and work has yet to reach a conclusion.
- 430 Previous RAIB investigations have found that tramways have not always used appropriate risk assessment techniques when assessing operational risk. Examples of this were found in investigations following an accident at Sandilands tram stop on 16 May 2012 ([RAIB report 03/2013](#)) and following an accident in Manchester at Market Street on 12 May 2015 ([RAIB report 06/2016](#)).
- 431 The RAIB observes that one way to promote good practice in this area would be for tramways to work collaboratively to identify hazards, and to discuss risk assessment techniques and ways of evaluating potential risk controls. To be fully effective this work would need to consider risks associated with infrastructure design, risks associated with operation and interaction between these issues.
- 432 The RAIB has also observed that, although designed to RSPG-2G, RSP2 or their predecessors, there is diversity in the design and operation of the various UK tram networks. Previous RAIB investigations (eg Market Street, [RAIB Report 06/2016](#)) have noted that RSP2 is in need of revision to better reflect good industry practice and to incorporate safety learning following previous accidents.
- 433 UKTram has not updated RSP2 since lead responsibility for updating RSPG-2G was transferred to it from ORR in 2015 (paragraph 69).

The role of the safety regulator

- 434 ORR's regulatory strategy provided a lower level of intervention for tramways than for other sectors, consistent with its evaluation of the risk and the regulatory framework in place for tramways. However, the RAIB's analysis of the evidence suggests that the overall level of risk on tramways, and the potential for multiple fatality accidents, is higher than previously assumed. For this reason, and given the scope for safety improvements in the sector, there is a need to review the regulatory strategy.

- 435 HMRI, then part of the Health and Safety Executive, approved the tramway before it opened in May 2000 (paragraph 68). This approval was in accordance with the Railways and Other Transport Systems (Approval of Works, Plant and Equipment) Regulations 1994. It was granted following the review of technical submissions and inspections of the infrastructure and rolling stock. Approval was granted on the basis that the tramway complied with relevant standards, legal requirements (eg those relating to highway design) and RSPG-2G.
- 436 In April 2006, HMRI became part of the Office of Rail Regulation. Its responsibilities continued to include the health and safety regulation of all railways including tramways.
- 437 April 2006 also saw the introduction of the Railways and Other Guided Transport Systems (Safety) Regulations 2006 (ROGS), which contained wide-ranging provisions to simplify and modernise the regulation of all railways in Great Britain including tramways. ROGS implemented the EU Railway Safety Directive 2004/49/EC in Great Britain and also repealed and replaced three sets of regulations from 1994: the Railway Safety Case Regulations, the Railway Safety Critical Work Regulations and ROTS. In respect of tramways, the main effects of ROGS were:
- the introduction of a new requirement on tramway operators to establish a safety management system of the same nature as the rest of the railway sector;
 - the continued management of safety-critical work in accordance with the requirements which also applied in the rest of the railway sector; and
 - the replacement, by 2008, of the requirement to obtain HMRI approval of new works and equipment with an obligation to have the safe introduction of new or significantly altered vehicles verified by an independent competent person (a process known as “safety verification”).
- 438 In line with the requirements of the Directive 2004/49/EC, the new regulations also required main line rail operators to hold safety certificates, and infrastructure managers to hold authorisations. Certificates and authorisations are issued by ORR following a review of an application by the railway undertaking concerned, and are conditional on each implementing a safety management system. However, the Directive did not oblige member states to apply the same rules to tramways and minor railways and, in common with the approach taken in many other EU member states, ROGS did not extend the safety certification provisions of the Directive to tramways.
- 439 However, tramways are required to establish a safety management system and are subject to inspection by ORR to verify the continued safe management of the tramway. ORR’s published guide to the application of ROGS states that:
- ‘lower risk sectors (tramways and transport systems that do not run at speeds above 40 kilometres per hour) do not need safety certificates, but must still have a written safety management system in place’.*
- 440 The Act that enabled the construction of the Croydon Tramlink required the operator to seek the Secretary of State for Transport’s approval before introducing new rolling stock. This approval function is delegated to ORR under an agreement with the Secretary of State. Such approval was granted for the introduction of the new Stadler Variobahn trams in 2012.

- 441 The managers, operators and maintainers of the UK's tramways must also meet the requirements of the Health and Safety at Work etc. Act 1974 and associated legislation.
- 442 ORR's safety regulation comprises proactive activities such as planned interventions, typically inspections, and reactive intervention in response to events and reports. While ORR's railway management maturity model (paragraph 233) is used as the basis for assessing the tramways' safety management, the elements of it are sometimes covered over a longer time frame than is the case for main line railways.
- 443 ORR carried out an inspection of TOL's driver management in October 2010 (paragraph 233), and an inspection of safety culture in 2012/3 (paragraph 239). Both inspections gave rise to recommendations which ORR considered to be minor and so did not justify further ORR work to establish whether they were being implemented. However, the RAIB observes that ORR twice found evidence that some tram drivers found the line controllers (who acted as their day to day line managers) to be less approachable than senior managers and that this might be discouraging drivers from reporting issues. A similar concern was reflected in the survey conducted by the RAIB (paragraph 228).
- 444 It is possible that follow-up action by ORR after these inspections might have helped promote a 'just culture' in which drivers felt more able to report their own mistakes and/or safety concerns. Although an improvement in this area could have led to the reporting of the serious overspeed incident on 31 October 2016, TOL's subsequent actions are unlikely to have avoided the accident as it had not appreciated the overturning risk associated with speeding at this location (paragraphs 180 and 215).
- 445 ORR's vision of safety regulation is explained in its health and safety regulatory strategy⁴³, last published in February 2015. The strategy sets out how ORR decides to prioritise its resources using a 'scorecard' approach for the railway industry: main line, London Underground, light rail and heritage. The scorecard system is based on judgements that include how well safety is being managed by the sector/organisation, public concern about the sector/organisation, ORR's confidence that a sector/organisation will sustain safety performance without regulatory intervention, and its ability to make a difference to that risk.
- 446 The outcome of ORR's analysis of the scorecards is a list of risk areas which are then ranked to allow resource allocation. As of 2015, ORR's plan was to allocate 43.4% of its resources to 'proactive work' (48.9 full-time equivalent posts). About 1% of this resource (0.49 full-time equivalent posts) was allocated to the UK's tramways. By way of comparison, the proactive resource that was planned to be allocated to the main line railway sector was more than 77% of the total (37.9 full-time equivalent posts); for the heritage railway sector it was 1.37% of the total (0.67 full-time equivalent posts).
- 447 ORR inspectors' own assessments of their input to the proactive oversight of tramways indicate that the actual resource committed to tramways during 2014-15 and 2015-16 was closer to 1 full-time equivalent post. Some of this inspector time was spent reacting to specific issues and carrying out residual approval activities.

⁴³ Available at www.orr.gov.uk.

- 448 Chapter 5 of ORR's published 'strategy'⁴⁴ for the regulation of health and safety risks' states that *'due to the relatively low speeds involved in built-up areas, fatalities are rare and trams have highly effective magnetic track brakes which can stop the tram very quickly'*. It goes on to record ORR's view that *'there are other authorities such as local authorities and highways agencies with responsibilities for safety on public highways, we limit our involvement to those areas where we can add value'*. Although there are other references to tramways in the strategy, no safety priorities are identified that are specific to tramways.
- 449 Taken together, ORR's planned allocation of resource to the proactive oversight of tramways and the wording in ORR's guide to ROGS suggest that the tramway sector was considered to be a low risk activity compared to other sectors, and that it was felt that there was limited scope to add value by more intervention. There is no evidence that HMRI/ORR had fully recognised the potential for multiple fatality accidents involving trams.
- 450 Table 5 (paragraph 93) shows that the frequency of accidents causing fatalities per route km (or per passenger journey) has been higher on tramways than for railways on the national network. This is not surprising given the much higher exposure of pedestrians to trams than is the case for trains. However, it illustrates that tramways carry significant levels of risk which must be managed. The RAIB also observes that there is scope for significant safety improvement on tramways (such as driving aids, improved design of crossings and public education).
- 451 Given the above the RAIB is recommending that ORR should review its long-term regulatory strategy for tramways (Recommendation 9, paragraph 491).

⁴⁴ ORR's strategic risk chapters are available at www.orr.gov.uk.

Previous occurrences relevant to this investigation

Occurrences on Croydon tramway

- 452 Four of the previous Croydon tramway events investigated by the RAIB have been caused in part by the driver (or, in one instance, an instructor) not undertaking actions for which they were responsible and for which there was no engineered safeguard to protect against a driver's mistake. Reliance on the driver was also apparent in the Sandilands accident on 9 November 2016. The four previous events are listed below:
- A derailment at Phipps Bridge on 21 October 2005 ([RAIB report 04/2006](#)) due to a driver not reacting to a track-side warning that the points were incorrectly set. This caused minor damage but there were no injuries.
 - A tram collision at New Addington on 23 November 2005 ([RAIB report 11/2006](#)) which occurred during thick fog after one driver passed a stop signal and a second tram ran into the front of a stationary tram causing significant damage. No injuries to passengers or staff were reported at the time, though subsequently two whiplash injuries were reported.
 - A derailment at Phipps Bridge on 25 May 2006 ([RAIB report 28/2007](#)) due to a driver not reacting to a track-side warning that the points were incorrectly set. The circumstances were similar to the derailment in October 2005 and again there were no injuries.
 - An incident at Wellesley Road on 15 June 2007 ([RAIB report 40/2007](#)) in which a passenger was dragged after becoming trapped in closing tram doors. Although a check was required to ensure that no one is trapped in doors before the tram moved off, neither the trainee tram driver, nor the instructor, did so.
- 453 Following a collision between a bus and a tram in Croydon in September 2008 ([RAIB bulletin 01/2009](#)), the RAIB recognised the risks associated with passengers being ejected through bus side windows. In this instance, the fixing between the window and the bus body failed, rather than the failure of the window glass observed at Sandilands. Bus safety lies outside the RAIB's scope so the RAIB could not make a recommendation related to the bus accident. The RAIB therefore wrote to relevant parties.
- 454 The RAIB's letter to the Department for Transport (DfT), sent on 6 January 2009 described the circumstances of the accident and then stated: 'the side windows at the front of the upper deck of the bus appeared to offer little protection to people sitting in the front seat in case of a collision of this type...we suggest that this accident has revealed an issue which should be allowed for in the standards and/or regulations governing the design of buses.'
- 455 The DfT's response dated 9 February 2009 stated 'There is no specific requirement for buses to have side windows and no requirement on strength of fixing when windows are fitted. This is the case in both domestic and international legislation'. There is no evidence that DfT considered whether an amendment to standards or regulations was appropriate.

- 456 The RAIB's letter to TfL, dated 6 January 2009 also described the circumstances before stating: 'we have identified the following matters which we would like to draw to your attention...the side windows at the front of the upper deck of the bus appeared to offer little protection to persons sitting on a front seat in case of a collision of this type'.
- 457 TfL responded with a letter dated 9 February 2009 stating: 'we will be reviewing [the matters raised by the RAIB] along with recommendations from our own investigations, through our internal safety governance arrangements, and taking action where appropriate to an agreed and prioritised timetable.' TfL has no record of taking any further action except for a note recording that 'DfT wrote to the RAIB that in their assessment, it is unlikely that any regulation was contravened in the design and fixing of the window.'
- 458 The remaining events on the Croydon tramway investigated (or the subject of a bulletin) by the RAIB were a fatal accident involving a cyclist being struck by a tram at Morden Hall Park on 13 September 2008 ([RAIB report 06/2009](#)); a derailment at East Croydon on 17 February 2012 due to defective equipment ([RAIB report 04/2013](#)); a person struck and seriously injured by a tram at Sandilands tram stop on 16 May 2012 ([RAIB report 03/2013](#)); a tram travelling with doors open on 13 April 2013 after the inadvertent isolation of an engineered safeguard ([RAIB report 05/2014](#)); and a derailment near Mitcham Junction on 29 December 2014 following an equipment failure ([RAIB bulletin 01/2015](#)). These are not relevant to the accident on 9 November 2016 as the driver was not a factor or the driver's actions were associated with a defective or isolated engineered safeguard.
- 459 Five other incidents on the Croydon tramway, summarised in table 17 (paragraph 375) but not investigated by the RAIB, were considered when reviewing fatigue management and the effectiveness of DSDs.

Occurrences outside Croydon tramway

- 460 The RAIB notes that a tram driver's loss of concentration (loss of awareness) also featured in its investigation of a pedestrian who was seriously injured when they were struck by a tram at Market Street, Manchester on 12 May 2015 ([RAIB report 06/2016](#)).
- 461 The RAIB's investigation has also considered events on European tramways (summarised in table 8, paragraph 216), first generation UK tramways (paragraph 217), UK road transport (table 9, paragraph 219), UK railways before the RAIB started operation (summarised in table 10, paragraph 220) and overseas railways (table 11, paragraph 221).
- 462 The RAIB made a fatigue-related recommendation arising from its investigation into two signal passed at danger (stop) incidents near Reading, Berkshire (discussed at paragraph 476). The incidents both occurred in the morning (one at 06:11 hrs, the other at 08:22 hrs) after a long night shift. The incidents caused no injuries or damage as, in both cases, the train was stopped by a TPWS brake intervention. Both drivers were fatigued because they were not sufficiently rested.

Summary of conclusions

Immediate cause

463 The tram overturned because it was travelling too fast to negotiate the curve (paragraph 95).

Causal factors

Causal factors relating to the driving of the tram

464 The tram did not slow down to a safe speed before entering Sandilands south curve because the driver did not apply sufficient braking (paragraphs 119 and 123). Although some doubt remains as to the reasons for the driver not applying sufficient braking, the RAIB has concluded that the most likely cause was a temporary loss of awareness of the driving task during a period of low workload, which possibly caused him to microsleep. It is also possible that, when regaining awareness, the driver became confused about his location and direction of travel.

465 The RAIB has identified a number of factors that may have influenced the driver's actions:

- a. low driver workload when approaching the accident site (paragraph 138 to 142, **Recommendations 3 and 4**);
- b. although there is no evidence that the driver's shift pattern carried an exceptional risk of causing fatigue, it is possible that the driver had become fatigued due to insufficient sleep when working very early turns of duty (paragraphs 143 to 152, **Recommendations 3 and 4**);
- c. disorientation of the driver (paragraph 153 to 156); and
- d. the infrastructure approaching the curve did not contain sufficiently distinctive features to alert drivers to their position relative to the curve at Sandilands or to their direction of travel in the tunnel (paragraphs 157 to 164, **Recommendation 5**).

Consideration of other factors

466 A serious overspeeding incident at Sandilands south curve on 31 October 2016 was similar in nature to the event that led to the overturning of tram 2551 on 9 November 2016. Even had full details of the incident been known to TOL's managers, the RAIB considers it unlikely that they would have recognised the need for urgent implementation of additional measures to mitigate the risk. This is because they neither knew how close the tram came to overturning, nor fully understood the actual level of risk associated with overspeeding on curves (paragraphs 180 to 191).

467 It is also relevant to note that design of the junction resulted in a tight left-hand curve. Although such curves are a normal feature of tramway design it is important that the risk associated with overspeeding is adequately mitigated (paragraphs 192 to 194, **Recommendations 2, 3 and 4**).

Underlying factors

468 The underlying factors were:

- a. LT and TOL did not recognise the actual level of risk associated with overspeeding on a curve (paragraph 195, **Recommendation 2**). This was for the following reasons:
 - i. route hazard assessments did not identify the need for additional mitigation due to the risk associated with overspeeding at Sandilands south curve (paragraphs 197 to 201, **Recommendation 10**).
 - ii. risk profiling for the Croydon network did not fully recognise the level of risk associated with a tram overturning (paragraphs 203 to 211, **Recommendation 10**);
 - iii. route hazard assessments and risk profiling relied on driver performance as the main means of mitigating the risk of overspeeding (paragraphs 202 and 212 to 214, **Recommendation 10**); and
 - iv. route hazard assessments and risk profiling did not take account of evidence from other tram, road and rail systems showing the level of risk associated with trams overturning (paragraphs 215 to 221, **Recommendation 10**).
- b. Although senior managers recognised the importance of learning from experience, there were a number of factors which prevented TOL from gaining a full understanding of the extent of late braking (probably partly because of a lack of distinct cues) on the approach to Sandilands south curve. These factors included:
 - i. a reluctance of some drivers to report their own mistakes (paragraphs 224 to 243, **Recommendation 12**); and
 - ii. potential safety learning from customer complaints was not fully exploited (paragraph 248, **Recommendation 13**).
- c. The risk associated with excessive speed around curves was neither fully understood by the safety regulator nor adequately addressed by UK tramway designers, owners and operators (paragraph 249, **Recommendation 2**).

Factor affecting the severity of consequences

469 All fatalities and a significant proportion of injuries occurred because the window and door window systems did not contain passengers within the tram. Although meeting regulatory requirements, the main bodyside windows on the right-hand side of the tram shattered and became dislodged, and some of the doors became detached (paragraph 277, **Recommendation 6**).

470 Two other factors affecting the consequences, both relating to the escape of passengers from the tram, were:

- a. the tram's emergency lighting did not work once the tram had overturned (paragraph 345, **Recommendation 7**); and
- b. Passengers' only feasible escape route was through the tram's windscreens (paragraph 350, **Recommendation 8**).

Observations and other issues

471 Although not linked to causes of the accident or the severity of its consequences, the RAIB has identified the following:

- a. TOL's management of the risk of tram driver fatigue was not in line with published industry practice in the following areas:
 - i. rosters and the monitoring of rest day working;
 - ii. fostering a culture that encourages drivers to report fatigue; and
 - iii. providing its drivers with adequate guidance on fatigue management.

(paragraph 362, **Recommendation 11**)

- b. In common with most trams and trains in the world, there was no device fitted that was capable of reliably detecting the driver's loss of awareness (paragraph 401, **Recommendation 4**).
- c. The CCTV on tram 2551 was not recording at the time of the accident (paragraph 408, action already taken paragraph 421 and **Recommendation 14**).
- d. Some of LT's vehicle maintenance instructions were not up to date (paragraph 422, **Recommendation 15**).

472 The RAIB also observes that UK tramways did not have a mechanism to promote effective sharing of safety information or the development of common approaches to the management of risk (paragraph 426, **Recommendation 1**).

473 Although there is evidence of some Croydon tram drivers sometimes exceeding the speed limit, generally by small amounts, there is no evidence that a speeding culture contributed to the accident (paragraph 383).

The role of the safety regulator

474 ORR's regulatory strategy provided a lower level of intervention for tramways than for other sectors, consistent with its evaluation of the risk and the regulatory framework in place for tramways. However, the RAIB's analysis of the evidence suggests that the overall level of risk on tramways, and the potential for multiple fatality accidents, is higher than previously assumed. For this reason, and given the scope for safety improvements in the sector, there is a need to review the regulatory strategy (paragraph 434, **Recommendation 9**).

Previous RAIB recommendation relevant to this investigation

475 The RAIB has not made any previous recommendations to UK tram organisations directly relevant to the accident on 9 November 2016.

Recommendation that is currently being implemented

Incidents near Reading, 28 March 2015 and 3 November 2015

476 An RAIB investigation into two incidents on the main line in which trains passed signals displaying a stop aspect ([RAIB report 18/2016](#)), found that driver fatigue was the immediate cause of both events (paragraph 461). The investigation found evidence that the associated underlying factors relating to fatigue management were present across the rail industry. Recommendation 2 was addressed specifically to freight operating companies but the improvements sought here are also likely to be applicable to tram drivers. Those responsible for implementing related Sandilands recommendations should (without delaying implementation of these recommendations) consider whether learning from the freight operating companies' work could assist the tram industry.

477 Recommendation 2 stated:

Freight operating companies should expedite a review of their fatigue risk management systems to ensure that they have sufficient controls (eg policies, company standards) in place which are consistent with published good practice (such as that from ORR and RSSB), including:

- *rostering and associated staffing levels (such as limits on working hours, overtime and consecutive shifts), especially for night shifts;*
- *appropriate use of biomathematical fatigue models (such as the FRI);*
- *training and education on fatigue for safety-critical workers and controllers of safety-critical work;*
- *fitness for duty checks when booking-on for duty;*
- *processes for gathering and using feedback, in an open and timely manner, from safety-critical workers on fatigue-inducing shift patterns; and*
- *in consultation with their occupational health advisers, screening and treatment for sleep disorders as part of medical assessments, both routinely and particularly where a worker has been involved in a suspected fatigue-related incident, and requirements on individuals to declare any known sleep disorders to their employer.*

478 The Reading report (paragraph 476) was published in September 2016 and ORR reported to RAIB on 28 September 2017 that implementation of Recommendation 2 was progressing.

Actions reported as already taken or in progress relevant to this report

479 In response to the Urgent Safety Advice issued by the RAIB (paragraph 65, Appendix F), additional signage, intended to remind drivers of the need to reduce speed, was added at Sandilands south curve before tram services restarted at this location (figure 54). LT report that it also installed additional signage at three other locations on the Croydon tramway.

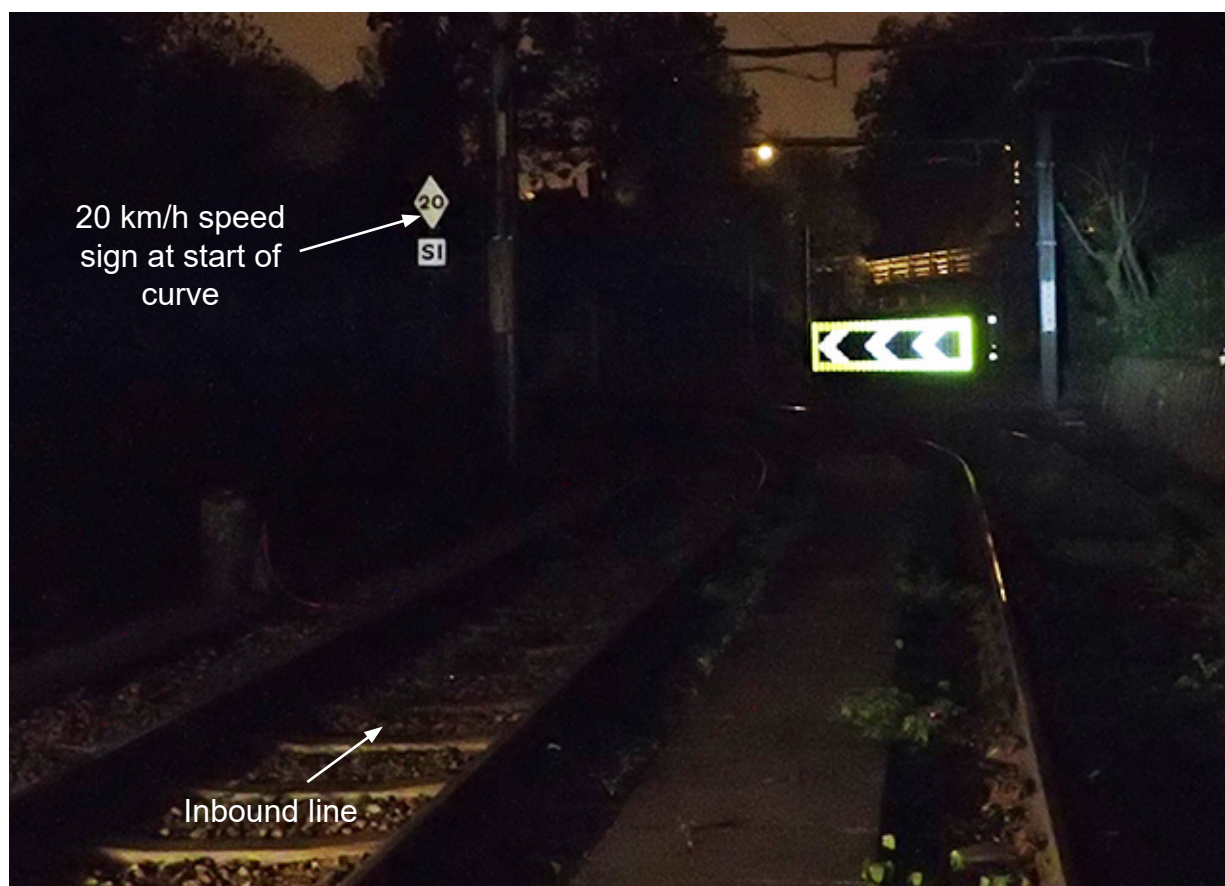

Figure 54: Chevron sign fitted as part of the signage changes at Sandilands south curve after the accident

480 Shortly after the Sandilands accident, Edinburgh Tramway, Midland Metro and Nottingham Express Tramway fitted additional signage at locations where there is a speed reduction of more than 30 km/h (19 mph), an ORR requirement triggered by the Urgent Safety Advice. Manchester Metrolink has informed the RAIB that it already had some signage to supplement standard speed signs at high risk locations and has fitted additional signage following a risk review triggered by the Sandilands accident.

481 The RAIB is aware of other tram industry actions intended to address issues identified by the RAIB investigation of the Sandilands accident. Some of these are described below. Where these actions overlap the RAIB's recommendations, the RAIB anticipates that the actions will contribute to implementation of the recommendations.

482 In October 2017, London Trams reported that its actions since the accident at Sandilands have included:

- installing additional signage on the curves approaching Sandilands junction and similar curves elsewhere on the Croydon tramway in response to the RAIB's urgent safety advice (paragraph 65);
- reducing the maximum permitted speed on the Croydon tramway from 80 km/h (50 mph) to 70 km/h (43 mph) with effect from September 2017;
- trialling tram activated signs which illuminate if trams approach a hazard at excessive speed;
- installing an in-cab vigilance/alertness system to all its trams;
- commencing a study into possible fitment of stronger glass to trams;
- investigating options for installing equipment which will prevent trams overspeeding;
- developing a specification for enhanced emergency lighting in trams; and
- replacing the CCTV recorders in the CR4000 trams with modern units incorporating a health monitor allowing remote monitoring of whether the equipment is working correctly.

483 In October 2017, Tram Operations Limited reported that its actions since the accident at Sandilands have included:

- installing an in-cab vigilance/alertness system for trams on the Croydon network (in conjunction with LT);
- participation in the UK tram industry equipment-based initiatives described in paragraph 484;
- working with a consultant to identify potential low frequency events with high consequences for tram safety and, in conjunction with LT where necessary, identifying any actions needed to deal with these;
- reviewing and updating its safety management system and key risk assessments (16 out of 24 policies are 'approved' and the remainder are being worked on);
- enhancing route hazard assessments, developing route risk assessments and reviewing the methods by which tram drivers acquire route knowledge;
- reviewing network risks in conjunction with LT; and
- engaging fatigue experts to review its fatigue management and roster arrangements.

484 UKTram has reported that UK tramways and UKTram are working on the following with the intention of sharing good practice among UK tramways:

- trialling various forms of signage;
- collecting information about fatigue management practices in UK tramways;
- reviewing options for automatic control of tram speeds approaching higher risk locations; and
- reviewing systems for monitoring driver attention.

Background to the RAIB's recommendations⁴⁵

- 485 Several of the recommendations identified as a result of the RAIB's Sandilands investigation apply to UK tramways beyond Croydon. Some cannot be implemented effectively without pooling expertise and information distributed among these tramways. Others would require substantial duplication of effort if carried out independently by each of the affected tramways.
- 486 The RAIB has addressed these recommendations to 'UK tram operators, owners and infrastructure managers' or 'UK tram operators and owners' as the legal entities with responsibilities for safety on the Blackpool, Croydon, Edinburgh, Manchester, Midland Metro, Nottingham and Sheffield systems. The recommendations are not addressed to the other UK tramways but the RAIB expects these minor tramways to take account of output from the recommendations to the extent that this is relevant to their operations.
- 487 Although addressed to individual operators, owners and infrastructure managers, the RAIB believes that it would be appropriate for these organisations to implement some aspects by cooperating through an organisation drawing together experts and organisations involved with the UK tram network. In order to be fully effective, this body will require expertise from other transport modes (eg mainline railway) and knowledge from tram systems outside the UK.
- 488 The RAIB believes that the Sandilands accident demonstrates the importance of a permanent body to facilitate a long term cooperative approach to UK tramway safety. The RAIB therefore recommends that the body set up to assist implementation of recommendations in this report should be (or become) a permanent body with this aim. To be effective, this body will need to occupy an authoritative position in the tramway world and in the UK highway world. In order to understand tramway safety issues, it will require both suitable funds and access to data from all UK tramways.
- 489 The existing trade body, UKTram, includes members from various parts of the UK tram industry but has informed the RAIB that, as currently funded and constituted, it could not undertake the role. This statement has been supported by UK tram operators consulted by the RAIB.
- 490 This report contains a recommendation, addressed to ORR, to develop an organisation capable of assisting in implementation of the recommendations applicable to the UK tramway industry. If suitably constituted, the RAIB would address future tramway related recommendations to the new organisation when appropriate. All recommendations in this report, except for Recommendation 1 (establishing the organisation), could be implemented without the organisation, or before it is formally established. Implementation of other recommendations should not be delayed by the implementation of Recommendation 1.

⁴⁵ On 21 July 2017 the RAIB sent a letter to UK tram operators, UKTram and the ORR identifying some of the areas likely to be covered by RAIB recommendations (Appendix I). This allowed these organisations to begin considering how they should address these topics in conjunction with actions which the tram industry was already taking in response to the Sandilands accident.

Recommendations

491 The following recommendations are made⁴⁶:

- 1 *The intent of this recommendation is to improve the management of safety risk in the UK tram industry by enabling more effective UK-wide cooperation.*

ORR should work with the UK tram industry to develop a body to enable more effective UK-wide cooperation on matters related to safety, and the development of common standards and good practice guidance.

As a minimum, the purpose and aims of this body should be to:

- i. provide a forum for the discussion of common safety issues and the exchange of experience;
- ii. the provision of authoritative and impartial advice and guidance on matters related to safety;
- iii. managing the development of safety related design and operational standards, and their subsequent maintenance;
- iv. participation in the development of industry standards and guidance by international bodies;
- v. sponsoring and project management of the research and development needed to inform the above;
- vi. gathering data, monitoring and reporting on the industry's safety performance (including comparisons of safety performance on different tramways);
- vii. providing suitable guidance on effective safety management, including guidance applicable to public highways;
- viii. working with tramways to help plan industry safety improvement; and

⁴⁶ Those identified in the recommendations have a general and ongoing obligation to comply with health and safety legislation, and need to take these recommendations into account, so far as is reasonably practicable, in ensuring the safety of their employees and others.

Additionally, for the purposes of regulation 12(1) of the Railways (Accident Investigation and Reporting) Regulations 2005, these recommendations are addressed to the Office of Rail and Road to enable it to carry out its duties under regulation 12(2) to:

- (a) ensure that recommendations are duly considered and where appropriate acted upon; and
- (b) report back to the RAIB details of any implementation measures, or the reasons why no implementation measures are being taken.

Copies of both the regulations and the accompanying guidance notes (paragraphs 200 to 203) can be found on the RAIB's website www.gov.uk/raib.

- ix. disseminating good practice from both the UK and overseas industries.

The body should be suitably constituted and funded to enable the effective delivery of the above functions. It should be structured so that ORR promotes, encourages and supports its operation (paragraph 472).

- 2 *The intent of the recommendation is to better understand all safety risk associated with tramway operation and then provide updated guidance for the design and operation of tramways (this could be achieved by issuing an updated version of the 'Guidance on tramways' with expanded coverage of operational matters). Particular attention will be required to recognise risks from low frequency / high consequence events which may not be apparent from precursor incidents on existing UK tramways. Identifying such events is likely to require input from specialists outside the UK tram community, including specialists with knowledge of main line rail and bus environments. Consideration of main line rail and bus issues is intended to inform evaluation of tramway risks; it does not imply that all heavy rail and bus requirements should be applied to tramways.*

UK tram operators, owners and infrastructure managers should jointly conduct a systematic review of operational risks and control measures associated with the design, maintenance and operation of tramways.

The review should include:

- i. examination of the differing risk profiles of on-street, segregated and off-street running;
- ii. safety issues associated with driving at relatively high speeds in accordance with the line-of-sight principle in segregated and off-street areas, particularly during darkness and when visibility is poor;
- iii. current practice world-wide and the potential of recent technological advances to help manage residual risk;
- iv. safety learning from bus and train sectors that may be applicable to the design and operation of tramways;
- v. consideration of the factors that affect driver attention and alertness across all tram driving scenarios in comparison to driving buses and trains; and
- vi. guidance on timescales for implementing new control measures (eg whether retrospective or only for new equipment).

Using the output of this review UK tram operators, owners and infrastructure managers should then, in consultation with ORR, publish updated guidance on ways of mitigating the risk associated with design, maintenance and operation of UK tramways (paragraphs 467 and 468).

- 3 *The intent of this recommendation is to prevent serious accidents due to excessive speed at higher risk locations on tramways. These locations are likely to include all locations where a substantial speed reduction is required for trams approaching at relatively high speed. Implementation of this recommendation may be assisted by work in this area already underway by Croydon tramway organisations.*

UK tram operators, owners and infrastructure managers should work together to review, develop, and provide a programme for installing suitable measures to automatically reduce tram speeds if they approach higher risk locations at speeds which could result in derailment or overturning (paragraph 465).

- 4 *The intent of this recommendation is to reduce the likelihood of serious accidents due to tram drivers becoming inattentive because of fatigue or other effects. Existing tram systems relying on drivers applying forces to driving controls (driver safety devices) do not necessarily detect an inattentive driver. Implementation of this recommendation may be assisted by work in this area already underway by Croydon tramway organisations.*

UK tram operators, owners and infrastructure managers should work together to research and evaluate systems capable of reliably detecting driver attention state and initiating appropriate automatic responses if a low level of alertness is identified. Such responses might include an alarm to alert the tram driver and/or the application of the tram brakes. The research and evaluation should include considering use of in-cab CCTV to facilitate the investigation of incidents.

If found to be effective, a time-bound plan should be developed for such devices to be introduced onto UK tramways (paragraph 471).

- 5 *The recommendation is intended to provide tram drivers operating on line-of-sight with signage giving visual information cues comparable to those for bus drivers. This recommendation builds on the RAIB's Urgent Safety Advice issued in November 2016 and recognises that driving a tram on line-of-sight has considerable similarities with driving a bus on a public road.*

UK tram operators, owners and infrastructure managers, in consultation with the DfT, should work together to review signage, lighting and other visual information cues available on segregated and off-street areas based on an understanding of the information required by drivers on the approach to high risk locations such as tight curves. Comparison should be made with the cues provided to road vehicle drivers on highways that are designed in accordance with current UK highway standards. Prior to the installation of suitable measures to automatically reduce tram speeds at higher risk locations (Recommendation 3) consideration should also be given to providing in-cab warnings to tram drivers on the approach to high risk locations.

The findings of this review should then be used by UK tram operators and tramway owners to improve the information and/or warnings provided to drivers at high risk locations in segregated and off-street areas (paragraph 465).

- 6 *The intent of this recommendation is to reduce the likelihood of people being seriously injured or killed by being ejected through tram doors and windows (ie to provide better containment). Although it is not expected that ejection can always be prevented in case of overturning, the improvement of containment will deliver improved safety in a range of different scenarios such as collision with road vehicles. Any improvement to containment is dependent on the ability of passengers to easily open doors in an emergency. It is expected that implementation will build on similar research already undertaken by RSSB in respect of railway carriage windows.*

UK tram operators and owners should, in consultation with appropriate tram manufacturers and other European tramways, review existing research and, if necessary, undertake further research to identify means of improving the passenger containment provided by tram windows and doors. The findings should then be used to:

- i. provide a time-bound plan to modify doors and windows on existing trams when practical to do so (eg during planned refurbishment);
- ii. promote changes to the specifications and standards governing the doors and windows of new trams; and
- iii. inform the Department for Transport of the findings to allow implementation of the safety advice at paragraph 492.

(paragraph 469)

- 7 *The intent of this recommendation is to provide emergency lighting which will operate without connection to remote power supplies such as the tram's main batteries and the overhead electrical supply. Implementation may involve tram operators seeking input from appropriate tram manufacturers.*

UK tram operators and owners should install (or modify existing) emergency lighting so that the lighting cannot be unintentionally switched off or disconnected during an emergency (paragraph 470).

- 8 *The intent of this recommendation is to minimise the risk of people being trapped in an overturned tram where side windows and doors are either facing the ground or facing the sky. Solutions could include the use of removable windscreens at the ends of trams. Implementation may involve tram operators seeking input from appropriate tram manufacturers.*

UK tram operators and owners should review options for enabling the rapid evacuation of a tram which is lying on its side after an accident. If the review identifies practical measures which would provide significant benefit to trapped passengers, UK tram operators and owners should:

- i. implement these measures on existing trams if practical to do so in the short term; or
- ii. provide a time-bound plan to implement these measures on existing trams when practical to do so (eg during planned refurbishment).

Such measures should then be promoted for inclusion in the specifications and standards governing the new builds of trams (paragraph 470).

- 9 *The intent of this recommendation is to ensure that the safety authority responsible for regulation of UK tramways maintains an appropriate, proportionate risk-based level of inspection and oversight to tramway operations.*

The Office of Rail and Road should carry out a review of the regulatory framework for tramways and its long-term strategy for supervision of the sector. This should be informed by a new assessment of the risk associated with tramway operations (allowing for low frequency/high consequence events of the type witnessed at Sandilands junction) and consideration of the most effective means by which supervision can contribute to continuous improvement in passenger safety (paragraph 474).

- 10 *This recommendation is intended to ensure that systems used by Tram Operations Limited and London Trams for identifying the hazards and assessing the risk associated with their operation are fit for purpose. The requirement for an independent review does not prevent it being carried out by other parts of TfL and FirstGroup provided the requisite expertise is available.*

Tram Operations Limited and London Trams should commission an independent review of its process for assessing risk associated with the operation of trams (eg collision, derailment and overturning of trams). This review shall consider:

- i. the extent to which the process for risk assessments is capable of identifying and correctly assessing all significant risks, particularly those related to low frequency/high consequence events; and
- ii. the means by which potential mitigations are identified and evaluated.

The findings of the review shall be incorporated into a documented process for the assessment of operational risk. This should also be shared with other tramways (paragraph 468).

- 11 *The intent of this recommendation is to minimise risk due to tram driver fatigue associated with both work and out-of-work activities.*

Tram Operations Limited, drawing on expertise from elsewhere in the FirstGroup organisation, should review and, where necessary, improve the management of fatigue risk affecting its tram drivers with reference to ORR's good practice guidance. As a minimum this should include a review of:

- i. the base roster with particular reference to whether it is appropriate to use a shift rotation pattern of about a week;
- ii. the management and monitoring of overtime and rest day working;
- iii. training, briefings and support for tram drivers regarding lifestyle, sleep hygiene and their individual responsibilities regarding fatigue and fitness for duty (including reporting when they feel that fatigue may affect their driving performance); and
- iv. competence requirements for managers and supervisors that have a role in the management of fatigue risk.

(paragraph 471)

- 12 *This recommendation is intended to encourage an organisational culture in which tram drivers feel able and willing to report safety incidents, and in which TOL takes suitable actions in response to information from both staff and the public. The requirement for an external expert does not preclude the review being carried out by other parts of TfL and/or FirstGroup provided the requisite expertise is available.*

Tram Operations Limited should undertake a review, informed by expert input from external sources, covering the way that it learns from operational experience. The areas the review should address are:

- i. fostering the creation of a 'just culture' in which staff are more likely to report incidents and safety-related concerns;
- ii. establishing a common understanding of what constitutes a safety incident when reported by the public, or that should be reported by staff;
- iii. improving management systems to ensure that safety issues are properly identified from any reports, whether from staff or members of the public, and that appropriate and timely actions are taken in response; and
- iv. developing improved processes to ensure that suitable lessons are learned by TOL from such reports and that outcomes are fed back to the reporter

(paragraph 468).

- 13 *This recommendation is intended to achieve effective and timely responses to allegations of unsafe situations reported by members of the public, or employees. It takes account of CCTV, OTDR and other systems which record data by overwriting earlier information after a period of time. It also takes account of the fact that witnesses' recollection of events can degrade relatively quickly. London Trams is included in the recommendation as improvements to processes and/or equipment relating to on-tram recording systems may be necessary to ensure a sufficient period for information to be available for downloading. Including workforce comments/complaints in the same system may further improve safety. Effective implementation of this recommendation is likely to include separating safety related comments from customer care issues and prompting people making comments to provide (where possible) the date, time and location of events.*

Tram Operations Limited and London Trams should, in conjunction with TfL, improve processes, and where necessary, equipment used for following up both public and employee comments which indicate a possible safety risk. The improved process should ensure complaints are dealt with promptly and within time periods which:

- i. improve the effectiveness of identifying complaints that are safety-related (eg time, date, location, safety or customer care event etc);
- ii. avoid the loss of technical evidence (eg CCTV recordings);
- iii. minimise the time before witness information is sought; and
- iv. ensure that appropriate action is taken without undue delay.

(paragraph 468)

- 14 *The intent of this recommendation is to maximise the availability of CCTV images which could assist accident and incident investigation (and also the investigation of criminal acts and anti-social behaviour). It considers both technical reliability and processes used to recover images before they are over-written. It is probable that equipment installed since November 2016 on trams similar to that involved in the accident will assist implementation of this recommendation.*

London Trams, in consultation with Tram Operations Limited, should review and, where necessary, improve its processes for inspecting and maintaining on-tram CCTV equipment to greatly reduce the likelihood of recorded images being unavailable for accident and incident investigation (paragraph 471).

This recommendation may apply to other UK tram operators.

- 15 *The intent of this recommendation is to ensure that up-to-date and accurate maintenance and testing documentation is available to tram maintainers.*

London Trams, in consultation with Tram Operations Limited should:

- i. review and, where necessary, revise existing tram maintenance and testing documentation to take account of experience gained, and modifications made, since the trams were brought into service; and
- ii. review and, where necessary, revise the processes for ensuring that these documents are kept up-to-date in future.

(paragraph 471)

Safety Advice

492 The RAIB has issued the following safety advice to the Department for Transport in respect of lessons learnt following the Sandilands accident that may be applicable to the bus industry:

The Department for Transport (DfT) should use the lessons learnt from the review of the containment provided by tram windows and doors (Recommendation 6) to establish whether this identifies potential safety improvements applicable to buses and coaches. In particular, whether there are circumstances in which it is reasonably practicable to improve the containment provided by windows and/or doors of existing and future vehicles without restricting emergency egress. If potential improvements are identified, the DfT should:

- i. disseminate this learning to bus/coach manufacturers, UK bus operators and UK transport authorities; and
- ii. promote changes to current standards governing these vehicles to reflect lessons learnt.

Note: This is issued as safety advice because the RAIB can only legally issue recommendations with the aim of improving railway safety.

Appendices

Appendix A - Glossary of abbreviations and acronyms

AIS	Abbreviated injury scale
CCTV	Closed-circuit television
DfT	Department for Transport
DSD	Driver's safety device
DVSA	Driver and Vehicle Standards Agency
FRI	Fatigue and risk index
FWI	Fatalities and weighted injuries
HMRI	Her Majesty's Railway Inspectorate
HSE	Health and Safety Executive
ISS	Injury severity score
LED	Light-emitting diode
LT	London Trams
OHLE	Overhead line equipment
ORR	Office of Rail and Road
OTDR	On-tram data recorder
PVB	Polyvinyl butyral
RAIB	Rail Accident Investigation Branch
RAIR	The Railways (Accident Investigation and Reporting) Regulations 2005
ROGS	Railways and Other Transport Systems (Approval of Works, Plant and Equipment) Regulations 1994
ROTS	Railways and Other Guided Transport Systems (Safety) Regulations 2006
RSPG-2G	Railway Safety Principles and Guidance Part 2 Section G: Guidance on tramways
RSP2	Railway Safety Principles 2: Guidance on tramways

RSSB	A not-for-profit company owned and funded by major stakeholders in the railway industry, and which provides support and facilitation for a wide range of cross-industry activities. The company is registered as 'Rail Safety and Standards Board', but trades as 'RSSB'.
SMS	Safety Management System
TBC	Traction/brake controller
TCL	Tramtrack Croydon Ltd
TfL	Transport for London
TOL	Tram Operations Ltd
TPWS	Train protection and warning system
UNECE	United Nations Economic Commission for Europe
VDV	Verband Deutscher Verkehrsunternehmen (Association of German Transport Companies)

Appendix B - Glossary of terms

Abbreviated injury scale	A six-point scale used to classify the threat to human life. The scale ranges from 1, for a minor injury, to 6 for an injury that is thought to be incompatible with life.
Adhesion	The grip of the tram's wheels on the rails.
Articulation unit	On a CR4000 tram, the short central part of the tram supported on wheels and with flexible joints to adjacent parts of the tram allowing the tram to pass around curves.
Automatic warning system	A safety system fitted on the UK main line rail network that alerts train drivers about the signal aspect or speed restriction ahead. A warning horn sounds in the driving cab approaching a red, single or double yellow signal aspect, or approaching a warning sign for a speed restriction. A bell sounds to indicate a green signal. The train brakes are applied automatically if the driver does not acknowledge the warning horn.
Ballast	Crushed pieces of stone used to support the track.
Bogies	An assembly including a metal frame with wheels which is pivoted at the ends of a tram to enable it to go round curves.
Braking points	Locations or features used by drivers as a point at which to begin braking. Features can include signs, bridges, buildings and tunnels.
Cant	The amount by which the outer rail on a curve is raised above the inner rail.
Cantlockers	Lockers housing tram equipment. Located inside the tram where the body side meets the ceiling.
Cantrail	The point along which the sides of a vehicle meet the roof.
Cess rail	On a two track tramway, the rails furthest from the adjacent track (see figure 11).
Check rail	An additional rail mounted alongside the inside rail in a sharp curve to restrict the lateral movement of the wheels (see left-hand image of figure 21).
Coast	A position on the CR4000 traction/brake controller that allows the tram to freewheel.
Crossover	A section of track and points that allow trains to change from one to line another.
Cruise	A position on the CR4000 traction/brake controller that applies power if required to maintain the current speed of the tram.

Dead man's handle	A system designed to automatically apply the brakes in circumstances where the driver has become incapacitated.
Door leaf	A single moving panel of a door.
Drive	A position on the CR4000 traction/brake controller used to accelerate the tram.
Driver's safety device	A system designed to stop a tram in circumstances where the driver becomes incapacitated.
Dropper	A vertical component within the overhead line equipment that supports the wire that contacts the tram's pantograph.
Duty	Details of the work to be done on a particular day, including booking on and off times, routes and trams to be worked, and break times.
Duty manager	A person responsible for overseeing day-to-day operations of the whole tramway system.
Dynamic performance	Performance of the vehicle in motion including ride quality and safety against derailments.
Dynamic simulation	A computer based analysis that enables an assessment of the dynamic performance of a rail vehicle by simulating the behaviour of the vehicle in motion on the track when responding to different input parameters such as track geometry and speed.
Fatalities and weighted injuries	A way of measuring actual harm where one fatality is considered statistically equivalent to agreed numbers of lesser injuries, the weighting varying by the seriousness of the injury.
Flange climbing derailment	A situation where the flange of a rail wheel rides up the inside face of a rail and crosses over the top of the rail head.
Flicker rate	The number of times a light flashes per second.
Friction coefficient	The ratio of the force necessary to cause one surface to slide across another, divided by the force normal to the surfaces.
Friction disc brakes	A system of braking where the retardation effort is provided by frictional contact between brake pads and a moving brake disk.
Grooved rail	Rail designed for use in streets. The rail cross-section incorporates a groove in which the wheel flanges run (see right-hand image of figure 21).
Hazard brake	A brake application, usually used only in emergencies, involving the track brake, service brake and the application of sand to the rails beneath the tram.
Heritage system	A railway or tramway operated as a tourist or museum operation, predominantly using equipment from bygone times.

Hopper window	A hinged window that can be opened by passengers to provide ventilation.
Inbound (track at accident site)	The direction of trams heading towards Croydon town centre from New Addington, Elmers End and Beckenham junction.
Injury severity score	An established medical assessment that provides an overall score for patients with multiple injuries.
Jacking point	Sections (sometimes stronger than adjacent sections of a vehicle) provided to allow jacks to be positioned to raise the vehicle off the ground.
Just culture	A culture of trust, learning and accountability in which people are not punished for their actions, omissions or decisions taken by them which are commensurate with their experience and training, but where gross negligence, wilful violations and destructive acts are not tolerated.
Light-emitting diode	A semi-conductor light source. Typically longer-lasting and more reliable than traditional light bulbs.
Line controller	A person responsible for the day-to-day operation of the Croydon tramway.
Line-of-sight	A method of operating in which the tram driver observes the line ahead and controls the tram's speed so that they are able to stop using the service brake before reaching a reasonably visible stationary obstruction.
Main line	The national rail network in Great Britain, now principally owned and operated by Network Rail.
Memorandum of understanding	A formal document that describes the arrangements agreed between two or more parties to define their roles and responsibilities.
Metro	An urban mass-transit rail system.
Microsleep	Unintentional periods of sleep lasting anywhere from a fraction of a second to a few minutes. They are often, but not always, characterised by the closing of eyes or head nodding actions.
Natural frequency	The frequency at which a system oscillates when not subjected to a continuous or repeated external force.
Newton	A measurement of force. One Newton is the force needed to accelerate one kilogram of mass at the rate of one metre per second per second (1m/s/s).
Off-street	Where the tramway is completely separated from the highway and the tramway alignment is separate from any highway [the situation at the accident location].

On-street	Where the part of the highway occupied by the tramway rails can be used by road vehicles or by pedestrians.
On-tram data recorder	Equipment which records speed and the status of various controls and systems. This data is analysed using bespoke software.
Outbound (track at accident site)	The direction of trams heading from Croydon town centre towards, New Addington, Elmers End and Beckenham junction.
Overhead line equipment	The overhead wires and supporting infrastructure that supply electricity to trams.
Overturning derailment	A derailment where the wheels on one side of a vehicle lift off the rails vertically rather than moving laterally off the rails.
Pantograph	A device fitted to the roof of an electric tram that contacts the overhead wires, allowing power to be supplied to the tram.
Plug type doors	A door which opens by means of a pushing motion out of a door opening in the vehicle body, followed by the door leaves sliding apart.
Points	A section of track with moveable rails that can divert a tram from one track to another.
Points bar	A metal lever used by tram drivers on the Croydon tramway to manually move points should their motors become defective.
Precursor	Precursors are indicators of incidents that under different circumstances could have led to an accident.
Proof load	A load that a structure must withstand without significant permanent deformation to demonstrate its structural integrity.
Rail profile	The cross sectional shape of a rail.
Regenerative braking	The use of the electric traction motors of a vehicle as generators in order to slow the tram. It is termed regenerative if the electrical power is returned to the supply line (OHLE).
Rheostatic braking	The use of the electric traction motors of a vehicle as generators in order to slow the tram. It is termed rheostatic if the generated electrical power is dissipated as heat in brake resistors.
Risk profiling	An exercise undertaken to identify the hazards and understand the level of risk that exists from an organisation's operations.
Roll (of a rail vehicle)	Rotation about a longitudinal axis.
Route hazard assessment	An exercise undertaken to identify the hazards that exist on a route, such as curves, road and foot crossings, and junctions.

Section Insulator	A short section of OHLE which does not supply electricity to the tram but which allows the pantograph to move between two sections of OHLE which do supply electricity.
Segregated	Where the part of the highway occupied by the tramway rails may be crossed by pedestrians but is not normally shared by road vehicles.
Service brake	Used for routine control of a tram's speed.
Six-foot rail	On a two track tramway, the rails nearest the adjacent track (see figure 11).
STATS19 data	A system used to record road accidents involving injury and reported to the police.
Stub (axle)	A short axle which only carries a single wheel of a vehicle, allowing a low-floor interior for improved access.
Survival space	The space normally occupied by passengers or crew. The loss of survival space as a result of severe structural deformation is likely to cause serious or fatal injuries if the affected space is occupied at the time of the accident.
Track brake	Electromagnetic rail shoes which adhere magnetically to the rail head. They are deployed when hazard braking is required and provide a shorter braking distance than the service brake.
Traction/brake controller	On the CR4000 trams this is the controller used by the driver to control the tram's speed and to apply its brakes.
Traction power	Term used to describe the electrical power used by the tram's motors to accelerate the tram.
Train Protection and Warning System	A system fitted to mainline trains which will automatically apply a train's brakes if it approaches a signal at too high a speed, or fails to stop at it, when it is set at danger. It will also automatically apply a train's brakes if it is travelling too fast on the approach to certain speed restrictions and buffer stops.
Wheel flange	The extended portion of a rail wheel that contacts the side of the rail head and thus provides the wheelset with directional guidance.
Witness marks	Marks that are left on objects when they contact each other.

Appendix C - Investigation details

C1. The RAIB used the following sources of evidence in this investigation:

- information provided by witnesses;
- information taken from the tram's on-tram data recorder (OTDR);
- loop data (paragraph 18);
- closed-circuit television (CCTV) recordings;
- site photographs, videos and measurements;
- testing of the tram and items of infrastructure;
- information provided by the British Transport Police, London Ambulance Service, London Fire Brigade, Metropolitan Police Service, London Trams and Tram Operations Ltd;
- organisational and regulatory documentation;
- British and European standards;
- TOL's roster arrangements;
- accident statistics for UK transport systems;
- information about fatigue management;
- weather reports and observations at the site;
- recordings of post-accident voice communications between the tramway and the emergency services; and
- a review of previous RAIB investigations that had relevance to this accident.

C2. The RAIB acknowledges the technical assistance provided by the following organisations during the investigation:

- Bombardier Transportation;
- British Transport Police;
- Horriba Mira Ltd;
- London Ambulance Service;
- London Fire Brigade;
- London Underground's Emergency Response Unit;
- London Trams;
- Metropolitan Police Service;
- Office of Rail and Road;
- PSV Glass;
- Tram Operations Ltd;
- Tramway Knowledge;
- Transport for London;
- TRL (formerly Transport Research Laboratory); and
- TÜV Rheinland InterTraffic GmbH.

Appendix D - Loop data

- D1. Signal loops between the tramway rails detect the presence of trams in order to trigger operation of signals and points. Trams are fitted with devices which transmit a wireless signal which is detected and then lost as a tram approaches and passes a loop. In addition to recording the information transmitted, the control system records the clock times at which transmissions were detected and then lost.
- D2. Although not designed to measure tram speed, data from these loops can provide an indication of speed. The RAIB has analysed data for the period from 1 January 2015 to 21 December 2016.
- D3. A small proportion of trams (less than 10%) passed the loops without suitable data being recorded for analysis by the RAIB. This could occur for reasons including equipment defects and trams stopping between loops. This has no significant effect on the overall assessment of tram speeds but means there is a low probability that an isolated extreme event has been missed.
- D4. The RAIB has calculated tram speeds based on the measured spacing of loops and the difference between the clock times at which first transmissions are first detected at these loops. Due to uncertainties described below, the information has been used to calculate a speed range rather than a precise speed.
- D5. Clock times are truncated to whole seconds when recorded and are reported in hh:mm:ss format. For example, times from 00:00:12.00 to 00:00:12.99 are all recorded as 00:00:12. For this reason a time difference of 6 seconds calculated from clock times of 00:00:12 at the first loop and 00:00:18 at the second loop could actually be between 5.01 seconds (00:00:12.99 to 00:00:18.00) and 6.99 seconds (00:00:12.00 to 00:00:18.99). For practical purposes this represents an uncertainty of +/- 1 second when using recorded times.
- D6. The recording system collects data from various items of signalling equipment and interrogates each individually at intervals of about 0.05 seconds. The time of interrogation is recorded and this can be up to about 0.05 seconds after the signalling equipment received the data. This causes an uncertainty of +/- 0.05 seconds in recorded transit times because, a lag of 0.05 seconds on the first loop time and no lag on the second loop time, would under-record the time taken by 0.05 second, and the reverse would over-record by the same amount.
- D7. The exact position of a tram relative to a loop when transmissions are first detected and then lost has not been determined. Differences only affect the RAIB analysis if the relative position of tram and loop differs on the same transit. Analysis of loop data showed that the effect of differing detection times was less than the +/- 1 second due to uncertainties associated with truncating times and could not be quantified more accurately because of the uncertainties of this truncation.
- D8. The issues described in paragraphs D6 and D7 mean that times obtained from loop data have an uncertainty slightly greater than one second. A more precise understanding of this uncertainty is not required for the purposes of the RAIB's investigation. Loop data has therefore been reported on the basis of a speed range calculated on a +/-1 second accuracy on the reported times between loops. The difference between this, and the actual accuracy, means that a small proportion of transits are likely to fall slightly outside the reported speed ranges.

Appendix E - Testing and examination of tram 2551 equipment

The testing and examinations reported below were intended to establish the tram's condition immediately before the accident. Minor defects unrelated to the accident (eg a possible requirement to change gearbox oil) and accident damage are therefore not reported as significant defects.

Part 1 – Visual and dimensional checks (except brakes)

Equipment examined	Results
Driver's seat including seat adjustment and security of fixing to tram.	No significant defect found.
Running wheels including wheel treads, wheel flanges, axle boxes, bearings, resilient elements, alignment and gauge.	Some lipping and minor defects. No significant defect found.
Primary suspension including suspension rubbers and mounting points.	No significant defect found. (Examination limited to areas of suspension visible with bogie complete and removed from vehicle).
Secondary suspension including springs, damper casing and bushes, body to bogie traction links and mounting points.	No significant defect found. (Examination limited to areas of suspension visible with bogie complete and removed from vehicle).
Bump and limit stops including clearance measurements.	Bumpstop missing on nearside of vehicle C. No significant defect found.
Flange lubricators.	Wheel 4 lubricator misaligned. All lubricators contained lubrication material. No significant defect found.
Traction gearboxes including oil levels and oil condition.	Some oil levels low or very low, not relevant to accident, sampling indicated oil replacement recommended. No significant defect found.
Vehicle to vehicle linkages including attachment points and interconnecting cables/pipework.	No significant defect found.
Obstacle deflector including alignment and height above rail.	No significant defect found.
Extendable jacking arms.	No significant defect found.
Bogie frames.	No significant defect found.
Bogie lift limit stop including gap measurements.	No significant defect found.
Bogie centre pivot including centre and side bearer shim spacing.	No significant defect found.
Load sensors (load in tram).	No significant defect found.

Part 2 – Electrical testing

The damage sustained to tram 2551 during the accident and subsequent recovery operation prevented the direct supply of power to the traction power supply equipment. Therefore, the electrical testing was undertaken using a temporary 24 volt DC power supply applied at a location appropriate for the equipment being tested. This replicated the power supply normally derived from the high voltage traction power equipment to feed the tram control and operational systems.

Where possible, all tests were conducted by applying the temporary supply to the main circuit breaker panel. This permitted the testing of the complete circuit from supply to control and actuator. Where this was not possible, the supply was provided as close to the main supply point as possible and the remaining circuit continuity checked. Where circuits had been severed by the accident or recovery process, the circuits were reinstated by temporary wiring as close to the break as practicable.

Equipment examined	Results
<p>Vehicle A main and dipped beam headlight function, including:</p> <ul style="list-style-type: none"> • driver control and indications; • alignment checked using LT maintenance equipment; and • alignment check using TRL equipment. 	<p>Main and dipped beam lights functioned correctly when commanded by drivers' controls.</p> <p>Beam alignment as tested using LT equipment:</p> <ul style="list-style-type: none"> • both high beams misaligned left of centre; and • both dipped beams correctly aligned. <p>Beam alignment as tested by TRL:</p> <ul style="list-style-type: none"> • nearside dipped beam correctly aligned; • offside dipped beam 0.7 degrees above correct alignment; • nearside main beam was 1.7 degrees left of centre (nominal alignment is straight ahead); and • offside main beam correctly aligned.
<p>Cab A windscreen washer and wiper.</p>	<p>Wiper and washer functioned correctly on all settings as commanded; washer fluid tank 60% full.</p>
<p>Cab A traction/brake controller (TBC); including outputs to OTDR and traction control processors in tram 2551. Transferred to an undamaged tram for functional testing.</p>	<p>No faults found, TBC functioned correctly and control inputs recorded on OTDR.</p>
<p>Cab A driver's safety device (DSD), including force required to maintain operation, reaction time upon release; and release recorded on OTDR.</p>	<p>DSD functioned correctly and operation recorded on OTDR.</p> <ul style="list-style-type: none"> • Force to operate DSD: 7N. • Force to prevent release: 6N. • Time from release to initiate brake application: 4 seconds.

Equipment examined	Results
Cab A emergency brake demand commanded using TBC and emergency plunger.	Emergency brake command functioned correctly and registered in control processor.
Sanding equipment, including function test, sand level and condition of sand.	Dry, loose and not discoloured sand in all sand boxes. Sand ejected after repair of damage (some, possibly all, damage accident related).
In cab alarms including fault alarms, DSD activated and other driver aids/warnings.	No significant defect found.
Cab A, in-cab radio.	No significant defect found (limited range of functions tested as beyond base station range).
Cab A environment controls including cab heater control and function, screen demisters and wing mirror demisters.	No significant defect found (unable to test recirculating heater without traction supply).
CCTV system, including: <ul style="list-style-type: none"> • camera function; • power supply; • wiring; and • recorder function. 	With test hard drive installed, DVR unit displayed: <ul style="list-style-type: none"> • LEDs lit for cameras 1,4,5 and 6; • LEDs extinguished for cameras 2 & 3; and • LEDs for HDR (hard-drive recorder) or record extinguished. Camera and monitor function: <ul style="list-style-type: none"> • Cab A driver's monitor non-functional, broken power switch; • Cab B driver's monitor functional • Camera 2 non-functional, broken connector; • Camera 3 non-functional, broken internal cable; and • Cameras 1, 4, 5 & 6 functional.
OTDR including date and time check, input signal channels and wheel diameter configuration. Moved to undamaged tram for functional test as part of speedometer testing.	No significant defects found except relating to speedometer readings, see Appendix H.
Speedometer including examination of speed probe and speedometer reading with generated speed probe output.	
Processors moved to undamaged tram for testing include traction/brake controllers (TBC), speedometers, EFB processors, ZLG processor, FSR processor, brake control unit, and OTDR.	
Passenger announcement system.	No significant defect found.

Part 3 – Brake examination and testing

Equipment, examinations and tests	Results
Friction brake system, including: <ul style="list-style-type: none"> • visual examination of hydraulic circuits, hydraulic fluid levels, brake isolation switches, ‘all brakes release’ switch and brake caliper micro switches; • measurement of friction pad thickness, pad/disk separation, brake pressures; response times of brakes, pressure in nitrogen system forming part of brake system; and • examination of slack adjuster position and operation. 	No significant defect found.
Dynamic brake system, including visual examination of roof-mounted equipment, examination of resistor grid, electrical resistance of resistor grid and continuity of control circuit wiring.	No significant defect found.
Emergency brake system, including: examination of brake condition and build-up of material on wear faces; examination of electrical connections; measurement of pole face wear; impedance of electro-magnet; voltage at electro-magnet. Local power supply used for these tests.	No significant defect found.

Appendix F - Urgent Safety Advice



URGENT SAFETY ADVICE

1. INCIDENT DESCRIPTION			
LEAD / INSPECTOR		CONTACT TEL. NO.	
INCIDENT REPORT NO	883	DATE OF INCIDENT	09/11/16
INCIDENT NAME	Sandilands Junction		
TYPE OF INCIDENT	Derailment/overturning		
INCIDENT DESCRIPTION	At around 06:07 hrs on Wednesday 9 November, a tram travelling from New Addington to Wimbledon derailed and overturned on the 30 metre radius, left hand curve on the approach to Sandilands Junction. Seven passengers were killed and many others injured, some seriously. Evidence gathered to-date indicates that the tram entered the curve, which is subject to a speed restriction of 20 km/h (12.5 mph), at around 70 km/h (43.5 mph).		
SUPPORTING REFERENCES	OTDR and other evidence gathered.		

2. URGENT SAFETY ADVICE	
USA DATE:	14 November 2016
TITLE:	Over-speeding risk at Sandilands Junction
SYSTEM / EQUIPMENT:	Tram operations
SAFETY ISSUE DESCRIPTION:	Sandilands junction is approached, from the New Addington direction, on a long, straight section of track in a tunnel. The speed restriction on this section is 80 km/h (50 mph). The 20 km/h sign associated with the curve is positioned adjacent to the curve entry transition and approximately 100 metres from the tunnel portal. A tram braking at a full service rate of 1.3 m/s ² will need a minimum distance of 180 metres to achieve the required speed reduction. Consequently a 75% reduction in speed is required in advance of a tight bend, with the initial braking point in a tunnel. We do not yet know why on the morning of 9 November, this speed reduction was not achieved.
CIRCUMSTANCES:	Before dawn in heavy rain.
SAFETY ADVICE:	The factors that led to the over-speeding are still under investigation. Until these factors are better understood, and before the junction re-opens to passenger operation, the RAIB advises London Trams and Tram Operations Ltd to jointly take measures to reduce the risk of trams approaching Sandilands Junction from the direction of New Addington at an excessive speed. Options for consideration should include the imposition of a further speed restriction before the start of the existing 20 km/h speed restriction around the curve and/or additional operational signs.

USA SIGN-OFF*			
INSPECTOR NAME:		CI / DCI NAME:	Simon French
INSPECTOR SIGNATURE:	ELECTRONIC COPY	CI / DCI SIGNATURE:	ELECTRONIC COPY
DATE:	14 November 2016	DATE:	14 November 2016

Appendix G - Post-derailment sequence



Figure G.1: Overview when front wheels become derailed (point of derailment). Tram is tilting over at about 10°. Note: the flexible connections between the sections of the tram are not shown for clarity.

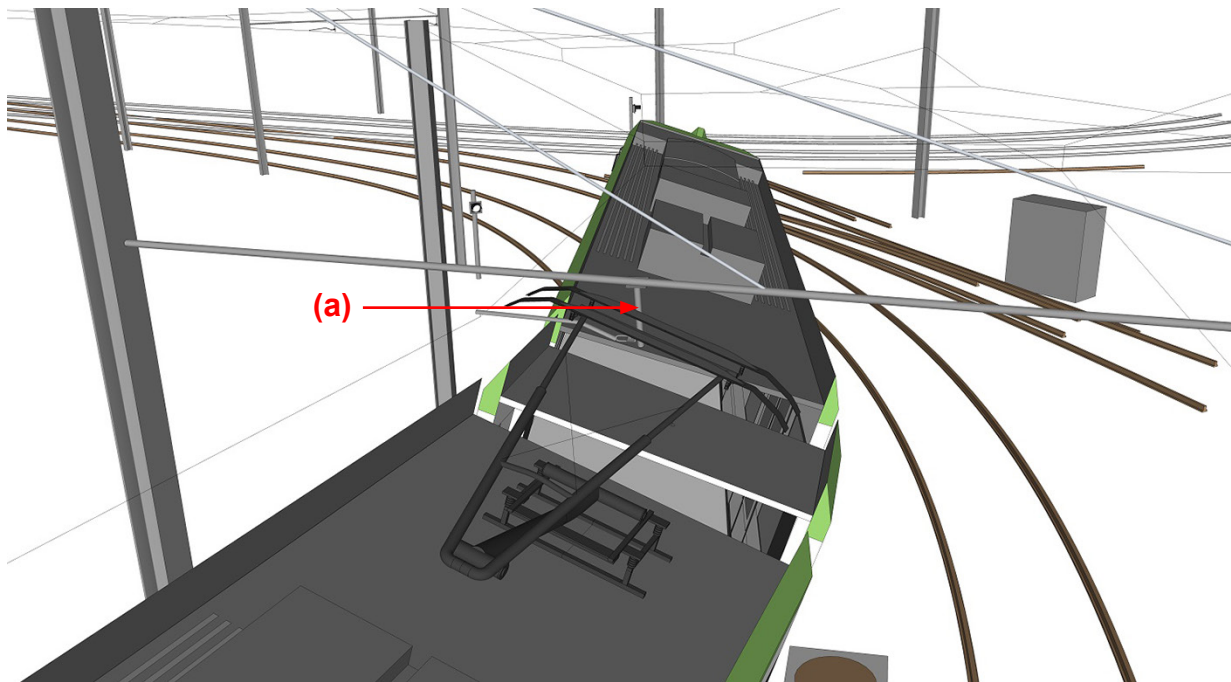

Figure G.2: As tram derails, pantograph strikes overhead line support tube (dropper) (a)

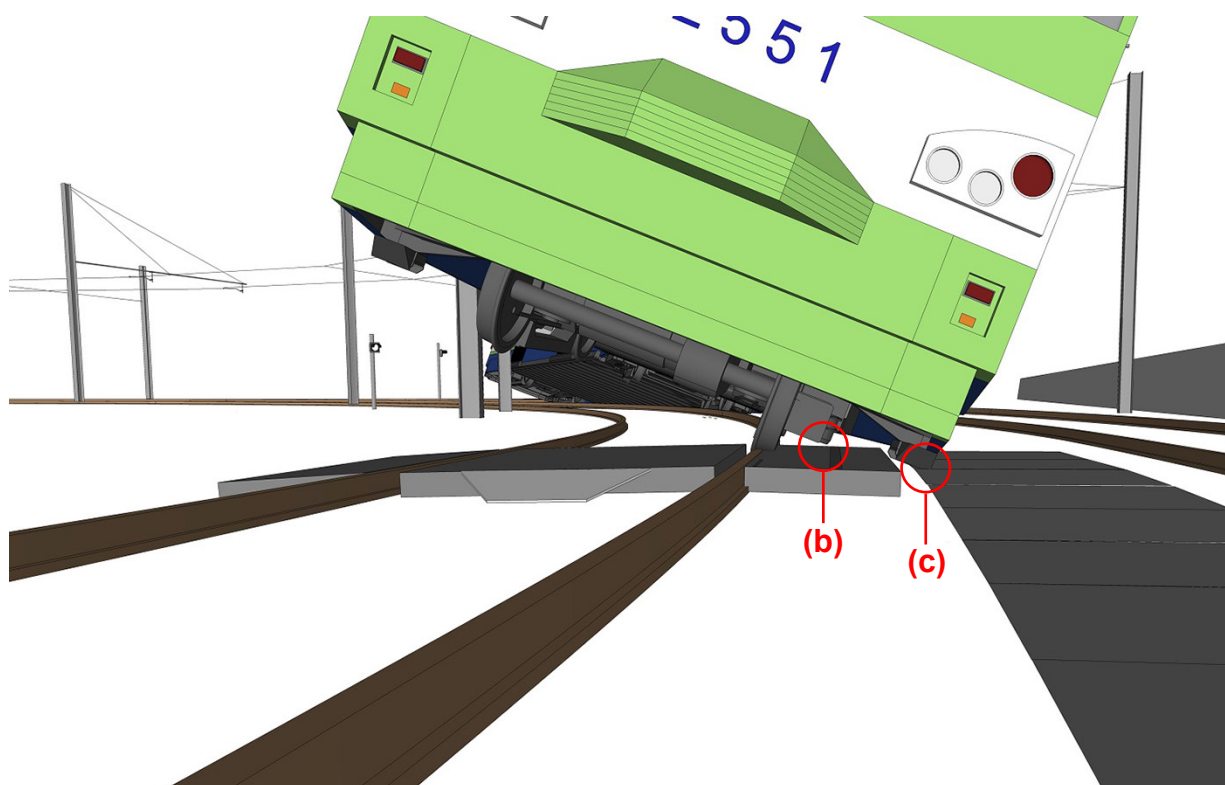

Figure G.3: Rear of tram suspension scuffs track crossing (b) and possibly, the jacking point damages walkway (c)

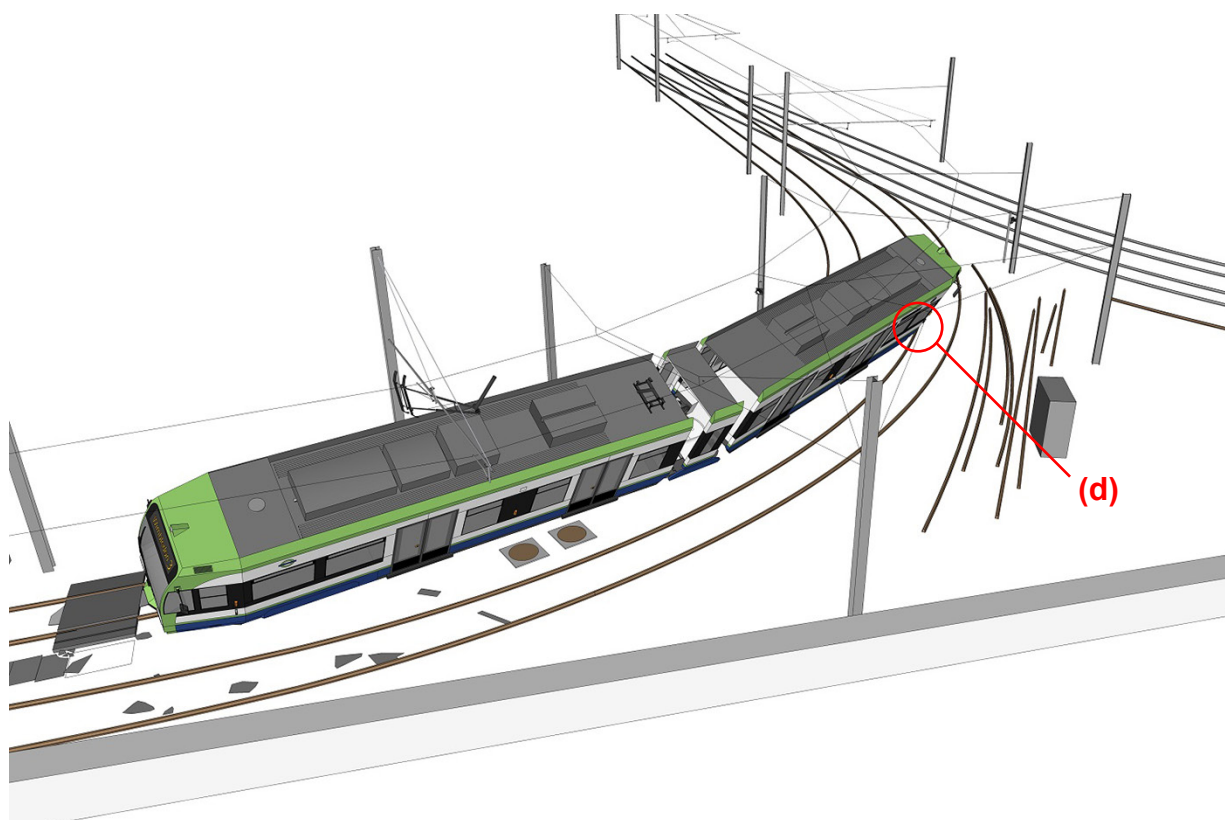

Figure G.4: Front of tram strikes and breaks six-foot rail of outbound line (d)

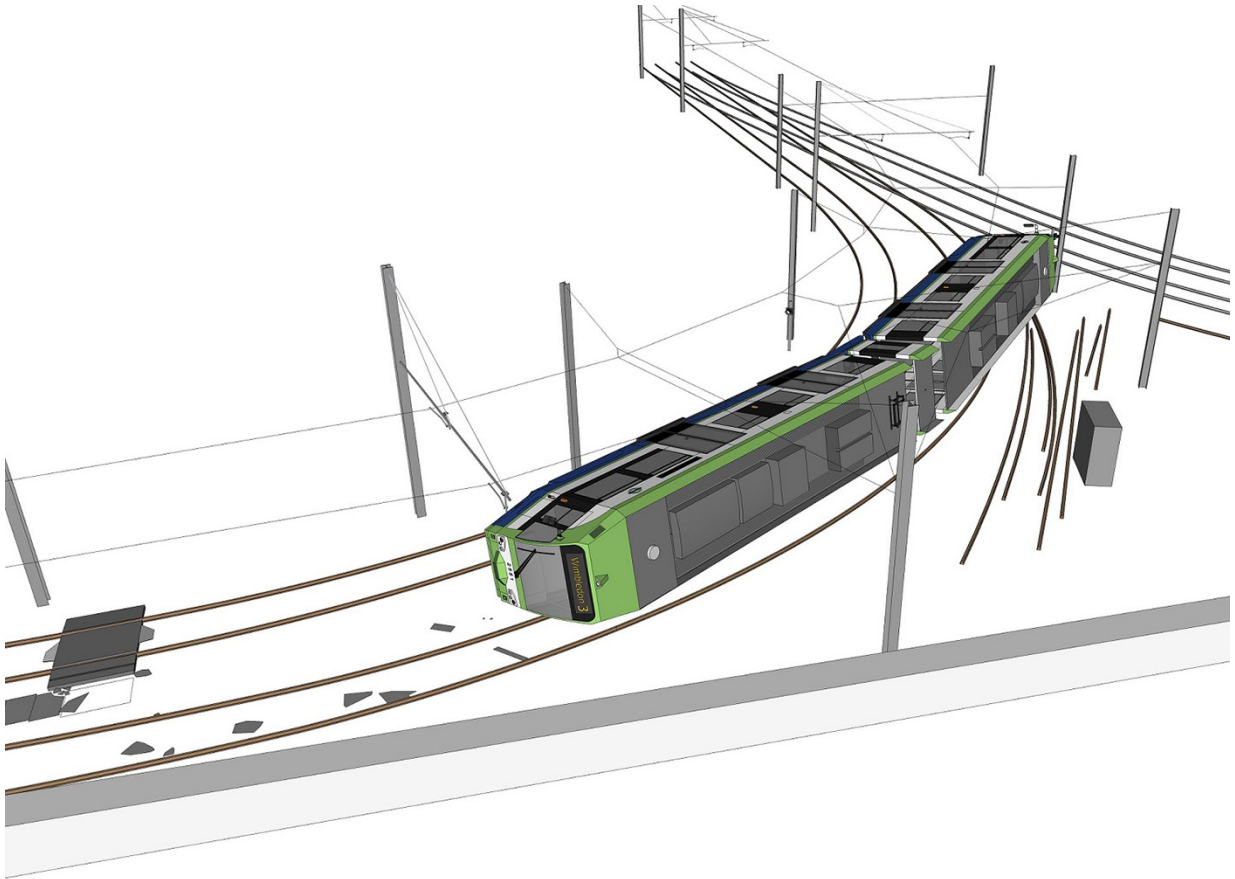

Figure G.5: Side of tram hits ground

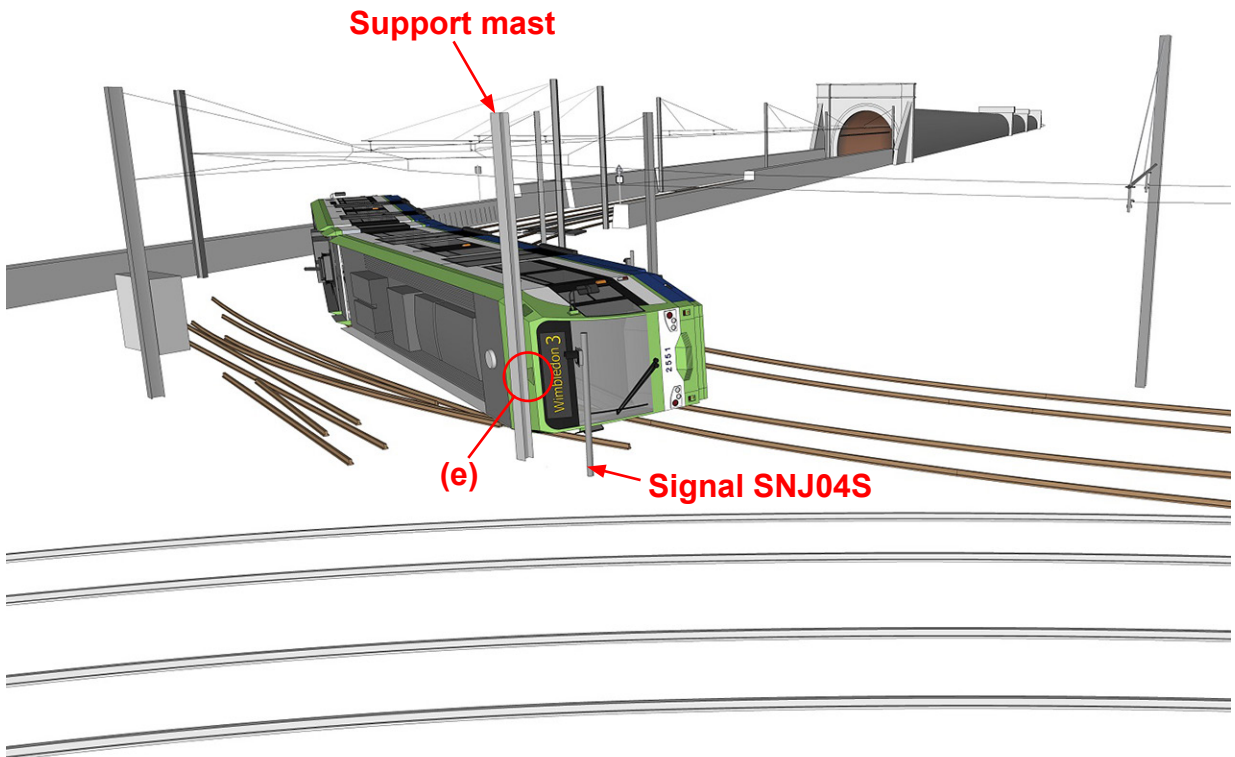

Figure G.6: Roof of tram hits overhead line support mast, displacing headlight from tram roof (e)

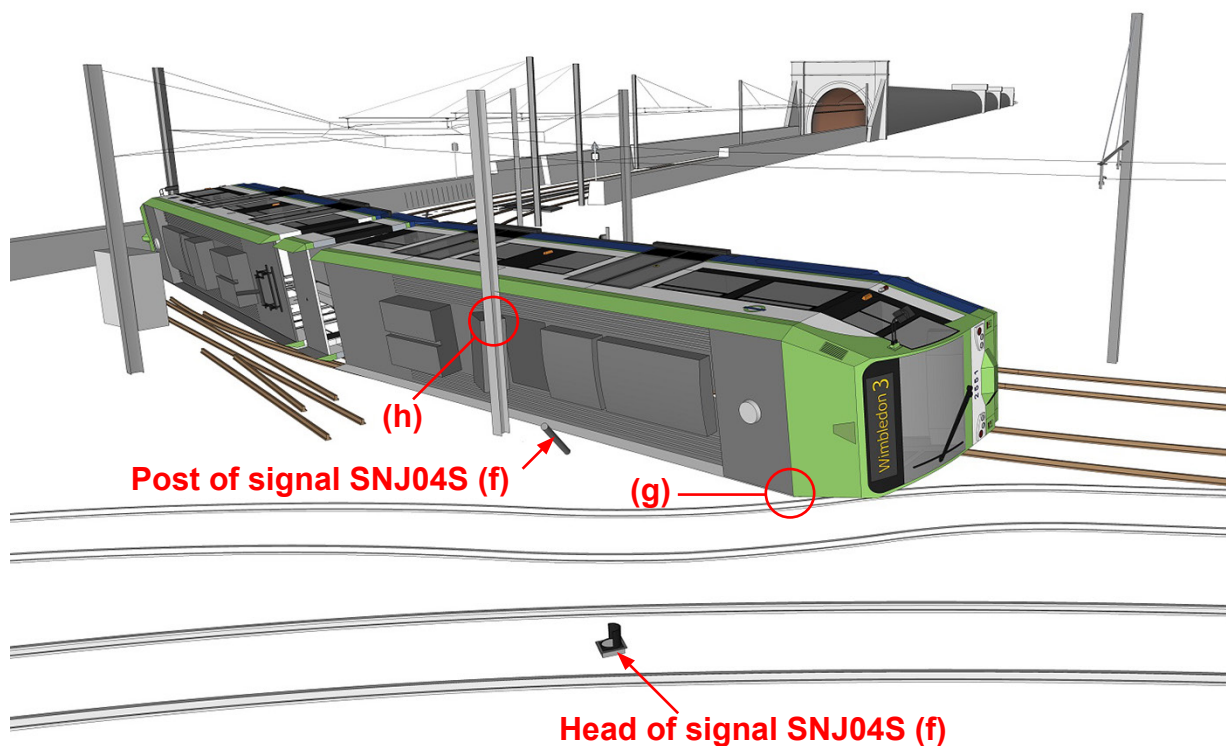

Figure G.7: Front of tram collides with signal (f), then track of inbound Addiscombe line (g). Roof equipment is displaced from tram as it slides against the overhead line support mast (h).

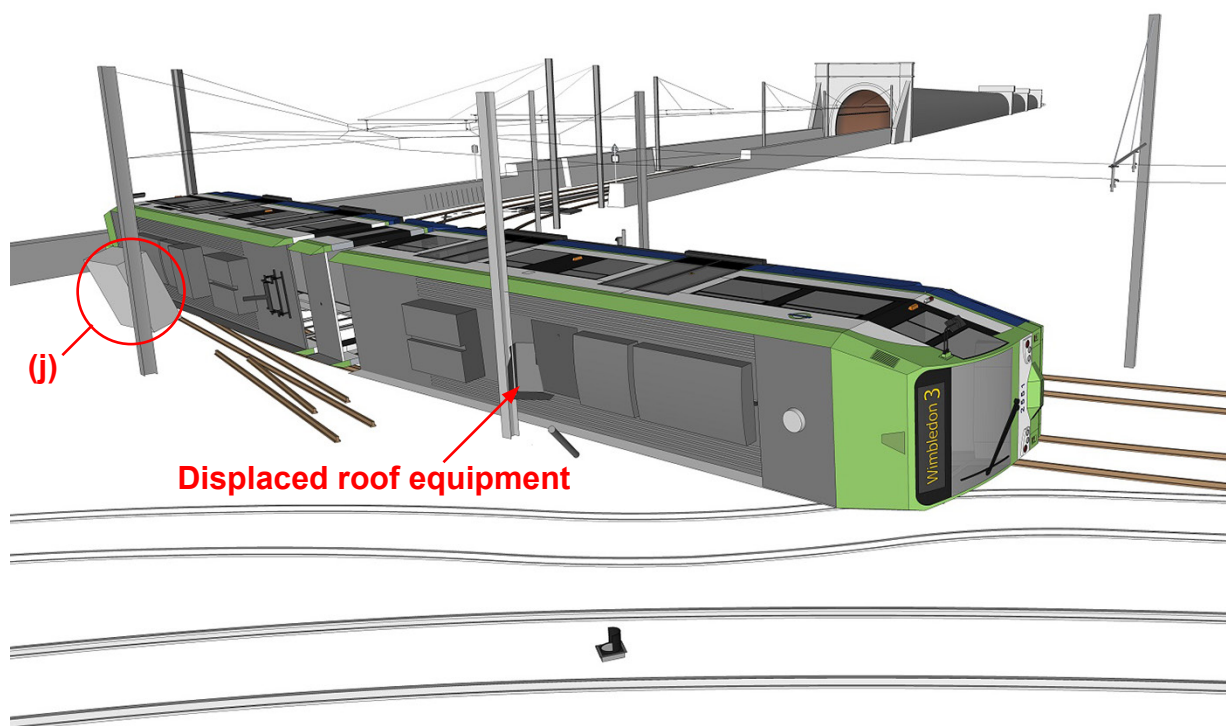
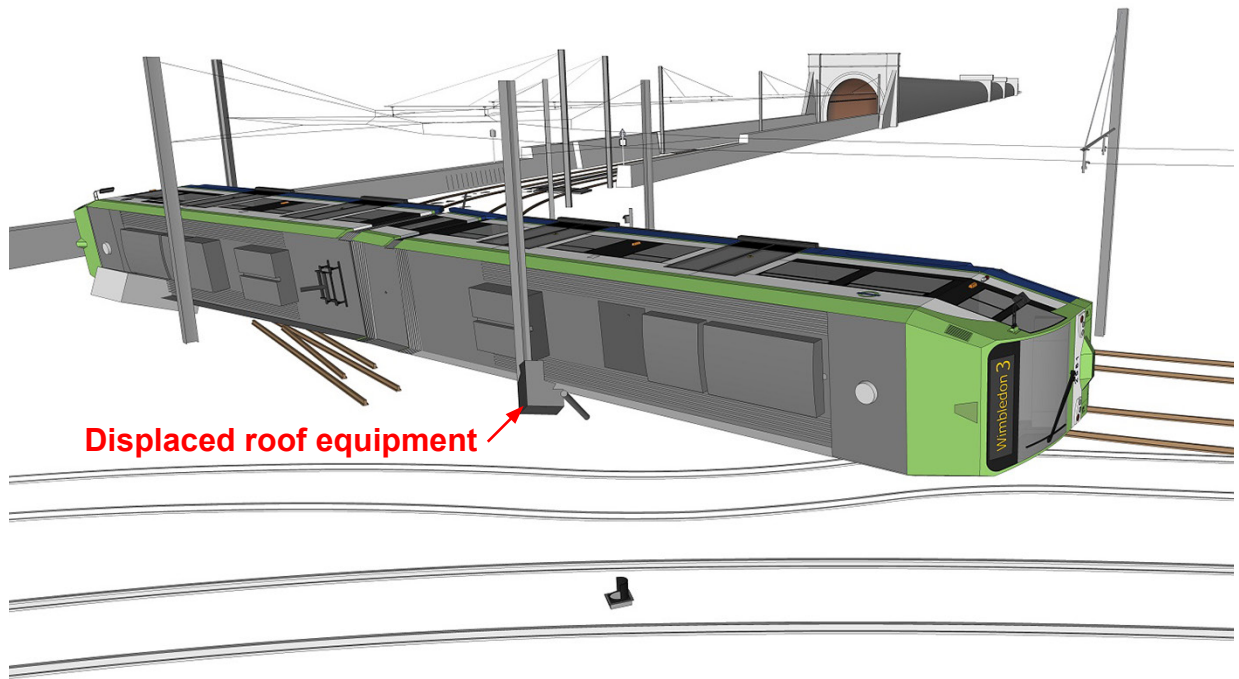

Figure G.8: Rear of tram collides with electrical equipment cabinet (j)



Displaced roof equipment

Figure G.9: Tram comes to rest

Appendix H - On-tram data recorder

- H1. Tram 2551 was fitted with an on-tram data recorder (OTDR). The data recorded includes whether the traction brake controller is in the 'drive', 'brake' or 'emergency brake' positions. It also includes the operation of the emergency plunger and track brake push button and demands for the sanding system to operate.
- H2. The OTDR also receives a pulsed input from a speed probe mounted on a wheel on the centre bogie. The total number of pulses counted within a period allows the OTDR to determine how many revolutions the wheel has turned. Using the diameter of the wheel, the distance travelled by the tram, and therefore its speed, can be calculated by the OTDR. The OTDR sends a signal corresponding to the calculated speed to the speedometers located in each driving cab. Small uncertainties with data recorded by the OTDR are caused by effects including wheel slip/slide and wheel diameter.

Wheel diameter

- H3. Wheel diameter is measured at a standardised point on the wheel's tread. A technician then enters this value manually into a processor within the tram's traction and braking system. The measurement should be updated after any activity which could alter the diameter, such as the wheel being replaced or re-profiled. Tram wheels are tapered across the width of their tread to assist guidance and the part of the tread in contact with the rail head will vary as a result of track curvature, wheel and rail profile and the action of the tram's suspension. The point where the wheel diameter was measured may therefore not represent the exact diameter of the wheel which is in contact with the rail head at a particular moment.
- H4. The traction and braking system processor uses the measured wheel diameter value to calibrate itself. It also transmits a corresponding value to the OTDR, accurate to 10 mm. The small differences introduced between these values, and the variable contact point along the wheel tread, mean that minor inaccuracies in speed and distance recording can be present in OTDR data. Analysis by the RAIB has shown that any resulting inaccuracies in the recorded speed are not likely to be significant. The effect of any distance errors was minimised by taking measurements from a point relatively close to the accident, in this case Lloyd Park tram stop.

Speedometer

- H5. The RAIB tested the OTDR fitted to tram 2551. This included testing the signals which fed into the OTDR and also the output from the OTDR to the speedometers. Testing of tram 2551 confirmed that data signal sources on the tram fed correctly to its OTDR and that the recorder would calculate the correct speeds for a given wheel diameter and a range of pulsed inputs. However, the testing also concluded that the speedometer readings on tram 2551 were low by around 5 km/h to 8 km/h (3 mph to 5 mph), when compared to the speed being calculated by the OTDR. This was outside the tolerance of 2.5 km/h (1.6 mph) permitted by London Trams standard speedometer test. The test also showed that negative value was displayed on the speedometer when a 0 km/h speed was being calculated by the OTDR.

- H6. Because tram 2551 had been subject to damage in the accident, the speedometer test was repeated on a second tram within a depot environment. This tram was fitted with the speedometers, speed probe and OTDR from tram 2551. As soon as the OTDR from tram 2551 was connected, the speedometers deflected to their maximum value, so the test was discontinued. The speedometers returned to normal operation once the OTDR from tram 2551 was replaced with the test tram's own recorder. The speedometer and speed probe from tram 2551 were found to operate correctly during testing on track when the test tram's own recorder was in place.
- H7. The OTDR from tram 2551 was then taken to its original manufacturer and subjected to a factory test. This concluded that the output from the unit to the speedometer was within the values specified by the manufacturer over a range of speeds and that the OTDR was otherwise functioning correctly.
- H8. The OTDR from tram 2551 alone was fitted to a third tram and the speedometer test repeated. This test concluded that the OTDR was calculating the correct speed, but that the speedometers were reading low by around 3 km/h to 4 km/h (1.8 mph to 2.4 mph) when compared to the speed being calculated by the recorder. This was again outside the permitted tolerance of 2.5 km/h (1.6 mph), although by a smaller degree than during the first test on tram 2551.
- H9. Drivers are required to report speedometer anomalies, such as the negative reading found in the first test. There is no evidence of such a report being made with respect to tram 2551 prior to the accident. There are also no other indications which suggest that the speedometer was under-reading compared to the OTDR when the accident occurred. It is possible that the test results seen are a consequence of damage sustained during the accident.
- H10. Although the RAIB's testing will continue, the errors measured in the tests are relatively small when compared to the degree of over-speeding present when tram 2551 entered the curve into Sandilands junction. The RAIB is therefore certain that a potential under-reading of the speedometer could not have been a factor in the accident.

Appendix I - RAIB July 2017 letter to the UK tram industry

Letter dated 21 July 2017 as sent by RAIB to all major UK Tram operators, to UKTram and copied to the ORR

Investigation into the fatal tram accident at Sandilands, 9 November 2016

Preliminary advice on the areas of RAIB recommendations

As you are aware, the RAIB investigation into the accident at Sandilands on 9 November 2016 is entering its final stages. We have completed the vast majority of evidence gathering and our subsequent analysis. We are now in the process of drafting our report and finalising the safety recommendations. We have discussed the draft recommendations, and our justifications for making them, with your organisations in recent weeks as part of the informal consultation process. Once we have completed our internal review of the report we will commence formal consultation of the entire report.

While the basic explanation of events that day remains as described in the RAIB's second Interim Report, we have gathered considerably more evidence in the intervening period. This has allowed us to identify a range of causal factors and issues, and to formulate draft recommendations that we believe are necessary to improve safety.

Our key recommendation areas applicable to UKTram and all UK tram operators are likely to include:

1. provision of active tram protection equipment to prevent serious accidents caused by excessive speed at high risk locations;
2. research into active means of detecting the attention state of drivers and intervening in the event of inattention;
3. improved containment of passengers by tram windows and doors; and
4. setting up of an industry body to facilitate more effective cooperation between UK tramway owners and operators on matters related to safety performance and the development of common standards.

In addition, the RAIB's investigation into how Tram Operations Ltd manage fatigue risk has revealed some areas of concern that are likely to feature in a recommendation.

Our final report will also highlight the importance of ensuring the availability of in-tram CCTV systems and any actions already taken to address the issue. If necessary, the RAIB will also make a recommendation for further improvements in this area.

Although our recommendations will only be formally issued once our report is published later this year, I am writing to advise that you give urgent consideration to the adequacy of your existing risk control measures in each of these areas, as appropriate, and the need for any actions beyond those you have already planned or implemented.

As the recent meetings made clear, the above list is not exhaustive, but includes some important safety issues that are likely to take time to address, hence my concern to give you early advice. Other areas within the scope of our investigation, such as the consideration of underlying safety management and regulatory factors, may also give rise to recommendations.

Once our final report is published the recommendations will be addressed to the safety authority for UK tramways, the Office of Rail and Road (ORR). You will then have a legal obligation to give each recommendation due consideration and to report to the ORR the actions taken in response.

We are aware that you have already started considering these issues and that some actions have already been taken. It would be desirable if you continue to inform the RAIB of any actions you take going forward, in order that these can be accurately reflected in our final report.

On the 03 August, we are planning to update the Sandilands entry on our web site to update the public on progress with our investigation and to give a first indication of the areas that are likely feature in our recommendations (as described in this letter). We are also in the process of providing personal briefings to the bereaved families. I therefore ask that in order to avoid any distress to these families you restrict circulation of this letter, and wider dissemination of its contents, until after our web site has been updated.

Yours sincerely

Simon French

Chief Inspector of Rail Accidents

Addendum (October 2018)

TfL's audit of TOL's fatigue risk management system

1. In June 2017 TfL conducted an audit of TOL's fatigue risk management system (as documented in SM003 – Safety Critical Employees – Management of Fatigue). This was in response to concerns that had been raised when a member of the public filmed a driver who was apparently asleep at the controls of a tram (paragraph 377), an event reported to RAIB by TfL. Although the audit report was completed in September 2017, it was not shared with RAIB and other investigating bodies until 12 February 2018⁴⁷. The RAIB's review of the audit report was therefore carried out following completion of its investigation.
2. The audit focused on the control of fatigue risk in the following areas:
 - governance;
 - education and training;
 - fatigue risk assessment;
 - fatigue reporting;
 - physical environment; and
 - audit and review.

The audit also compared TOL's fatigue risk management system with respect to the ORR guidance document 'Managing Rail Staff Fatigue'.

3. The audit found that TOL had effective control measures in place with regard to: communicating its standards and limits on working hours; managing variances in hours worked (eg overtime); employee consultation on roster changes; and control room staff checking for signs of fatigue when drivers book on for duty. However, it identified the following areas for potential improvement:
 - updating SM003 to detail the roles and responsibilities of those managing fatigue;
 - formalising the process for determining how and when to carry out a fatigue risk analysis;
 - consideration of ORR and industry good practice guidelines when designing the rosters and managing changes to drivers' hours of work;
 - training staff to recognise fatigue in themselves;
 - reviewing fatigue awareness training for managers and supervisors to ensure it includes factors that increase fatigue, and recognising fatigue in drivers when booking on;
 - analysing data available from monitoring of data such as overtime and exceedances;
 - documenting the procedures for the management of fatigue by the control room and supervisors;

⁴⁷ The audit report was finalised on 15 September 2017 and discussed at TfL's Safety, Sustainability and Human Resources Panel on 22 January 2018. After this meeting it became apparent that the report had not been shared with investigating bodies outside TfL and on 12 February 2018 the report was sent to RAIB, ORR and BTP.

- reviewing the need to determine if those on late shifts should be classified as night shift workers; and
 - formalising the arrangements for considering the design of the cab and the driving environment as fatigue risk factors.
4. TOL has informed the RAIB that it does not consider that the published audit report accurately reflects the status of fatigue management in the TOL organisation at the time of the audit in June 2017. TfL had issued TOL with a draft of the audit report in July 2017 but subsequent correspondence and meetings between the two organisations did not resolve their differences concerning certain elements of the audit. Although TOL disagrees with parts of the TfL audit, it states that the actions it has taken mean that the TfL audit recommendations were 'largely completed' by September 2018.
 5. TOL stated that it had carried out a review of its fatigue management policies and procedures before the TfL audit in June 2017 and, on 4 July 2017, it commissioned an external specialist organisation to review its management of fatigue. In September 2018, TOL reported that the actions taken in response to this work included enhanced biomathematical modelling and monitoring of drivers' overtime and rest day working, driver fatigue workshops and an ongoing programme of other activities intended to improve TOL's management of fatigue.
 6. Other actions taken by TOL and TfL have begun to address recommendations made by the RAIB in its December 2017 report (and foreshadowed by RAIB's letter to the tram industry in July 2017; Appendix I). These include the installation of a device in the cabs of trams to detect a loss of driver alertness and to warn against the visible effects of driver fatigue.
 7. The RAIB's review of the TfL audit report identified no evidence of additional factors, beyond those already discussed at paragraphs 362 to 382, which are likely to have contributed to the accident at Sandilands junction. However, the RAIB observes that the conclusions of the TfL audit are consistent with its own finding that, at the time of the accident, TOL's management of fatigue risk was not in line with published industry practice, and that there was significant scope for improvement. This is the subject of RAIB's recommendation 11 (paragraph 491).

This report is published by the Rail Accident Investigation Branch,
Department for Transport.

© Crown copyright 2018

Any enquiries about this publication should be sent to:

RAIB	Telephone: 01332 253300
The Wharf	Email: enquiries@raib.gov.uk
Stores Road	Website: www.gov.uk/raib
Derby UK	
DE21 4BA	