Stability Guidance for Fishing Vessels of under 15m Overall Length

Notice to all Shipyards, Boatbuilders, Fishing Vessel Operators, Skippers, Fishermen, Designers and Consultants

PLEASE NOTE:-

Where this document provides guidance on the law it should not be regarded as definitive. The way the law applies to any particular case can vary according to circumstances - for example, from vessel to vessel and you should consider seeking independent legal advice if you are unsure of your own legal position.

Summary

This Notice:

- Provides guidance for stability assessment to help fishermen make decisions.
- Strongly recommends owners and skippers to commission and purchase new vessels which have had a stability assessment and stability information supplied.
- Re-iterates that full stability requirements for the 12m registered length – 15m overall length fishing vessels will be re-introduced in the near future.
- Indicates that at the present time there is no intention to introduce compulsory stability criteria to fishing vessels under 12m registered length.
- Vessels over 12m registered length which have historically been roll tested may continue to do so.
- Skippers and owners are reminded that beam trawlers have a 20% uplift with the full stability criteria and their own formula for a roll test (only applicable to existing vessels which have previously been on a roll test).

1. Introduction

- 1.1 Vessels under 15 metres LOA are not currently required to have approved stability that is compliant with statutory requirements. There is presently no intention to introduce statutory requirements for vessels under 12 metres registered length.
- 1.2 Any vessel must be stable for its intended purpose and it is reasonable to expect that naval architectural skills will be employed during the design and construction process to ensure that the vessel is safe for use. MCA recommends that all purchasers ask for stability information from builders.

- 1.3 No vessel can be designed to be inherently safe; this depends upon the way it is operated. Therefore a vessel must be operated in such a manner that keeps it stable and provide a safe working platform for those onboard, whatever the purpose of the vessel or the operational circumstances.
- 1.4 Unfortunately it is not possible to make an assessment of stability and hence the safety of the vessel by simple inspection; however, various tools and assessment methods can be used to provide a degree of confidence and assurance.

2. Legal Responsibilities

- 2.1 While no specific statutory requirements currently exist for the stability of small fishing vessels, the owner, skipper and others do have legal responsibilities as detailed under the Merchant Shipping and Fishing Vessels (Health and Safety at Work) Regulations 1997.

For example their duties include ensuring, as far as is reasonably practicable:

- Systems of work that are, so far as reasonably practicable, safe and without risk to health,
- Safe arrangements for the use, handling, and stowage and transportation of articles and substances,
- there is provision of information, instruction, training and supervision necessary to ensure health and safety of workers and other persons.

- 2.2 In the absence of specific statutory requirements for stability and its subsequent approval of stability, owners may use other methods to assess stability and support skippers and fishermen to meet their health and safety general duties and responsibilities. It is not acceptable to do nothing and assume the vessel's stability is satisfactory. It is always better to assess the situation or obtain professional advice and this notice helps by providing additional information for this process. In short, MCA is providing a number of methods you may find helpful. MCA Fishing Vessel Surveyors cannot decide which method of stability assessment is best for your vessel (that is for owners/ skippers and crews to decide), but they are available to discuss the pros and cons of each method and may be able to identify specific risks/ similar vessels/ fishing methods which may assist owners/skippers and crews in coming to a decision on which stability assessment method best fits their vessel.

3. Some factors to consider and some myths

- 3.1 A number of factors can affect a vessel's stability, for example its length and breadth, the freeboard, the centre of gravity of the ship and equipment, distribution of weights such as in the fish hold, on deck, in hoppers, in nets, fuel, water and stores etc. Research has shown the importance and effect on stability of maintaining adequate freeboard. The weathertight deck, hatches and doors should be kept closed and decks should be kept clear of water and other movable weights. While a vessel may appear very 'stiff' because of her large beam, if the freeboard is small there may be little reserve of stability when the vessel heels or is in large waves due to the dangers of downflooding. Also a vessel which appears very sea-kindly and comfortable with a slow roll period can actually be potentially unsafe in terms of stability. Keeping water off the deck by closing scuppers or freeing ports may seem sensible and safe, but does have the opposite effect if a wave comes onboard and causes instability because of the trapped water and its free surface effect. It is also vital that the catch is not stored on deck, it should be stored as low as possible in the vessel as soon as is practicable.

4 Available Stability Methods

4.1 The following methods are considered:

- Full stability information, inclining experiment and calculation.
- Small Commercial Vessel Code standard.
- A modified small passenger vessel standard.
- IMO Roll Period Approximation.
- Wolfson Guidance.

5 Full Stability Method

5.1 This requirement will apply to all vessels over 12 metres and is widely used.

5.2 The method requires the lightship weight and centres of gravity both vertical and longitudinal to be ascertained (e.g. inclining experiment) and that the stability for a series of loading conditions be calculated.

5.3 The properties of the GZ Curves are then compared with the criteria reproduced here at Annex 1 and Appendix 1 to that Annex.

5.4 Many Naval Architects consider that the established criteria are good for vessels above 7m registered length.

5.5 Vessels which have previously been on a roll test, if they have had no structural modifications, may continue on the roll test until modified. Should they have been modified or wish to modify they must contact the MCA and prepare for hull stability assessment.

6 Small Commercial Vessel Code Standard (heel test)

6.1 This method requires checking the heel, resultant from the application of the maximum load on the maindeck at the maximum outboard position, is within 7°, together with sufficient freeboard.

6.2 The method may only be used for vessels carrying up to 1000 kg of cargo, in this case fish, and may not be most suited for cockle/mussel dredgers bagging the catch.

6.3 This method has distances from port as limits of operation.

6.4 For further details see Annex 2.

7 Small Passenger Vessel Heel Test

7.1 As an alternative to the Small Commercial Vessel Code heel test standard, an equivalent test can be used to that on small passenger vessels, which allows for weights in excess of 1000 kg.

7.2 It considers a shift in passenger, or in this case landed fish weight, with an assumed distribution of 2/3 : 1/3 on each side of the vessel. This gives a simple formula of $WB/12$ (see Annex 3, paragraph 6.0) as a heeling moment which when applied should not exceed a vessel heel of 7°, plus a minimum freeboard requirement.

7.3 This method can be repeated to check for changes over time.

7.4 For further details see Annex 3.

8 Roll period Approximation (IMO)

8.1 This is an operational comparative method to determine whether the vessel is stiff or tender.

8.2 Because of its simplicity it can be used operationally by the skipper.

8.3 This method is particularly useful to assess changes which can affect stability during the life of the vessel (if the roll period increases the vessel is becoming less stable).

8.4 Refer to Annex 4 for further information.

9 Wolfson Guidance

9.1 Overview

9.1.1 During 2003 to 2006, the Maritime & Coastguard Agency in response to the Marine Accident Investigation Branch (MAIB) Recommendations, sponsored a number of initiatives aimed at reducing the number of stability associated accidents onboard United Kingdom fishing vessels.

9.1.2 These initiatives included earlier work on identifying the use of a stability model for increasing “stability awareness” and the commissioning of research into a system which would inform the skipper concerning his management of stability.

9.1.3 The research was conducted by the Wolfson Unit of the University of Southampton.

9.2 Deliverable

9.2.1 Deliverables from the research included;

9.2.2 To produce a “traffic light” system which would inform the user of the level of risk associated with a particular operation, and;

9.2.3 to provide a baseline which could be used over time to recognise degradation of stability due to the acquisition of lightship by growth or the retention of equipment, stores or supplies.

9.3 Research Results

9.3.1 The research results have been published and are available on the Wolfson website, at www.wumtia.soton.ac.uk.

9.3.2 The Method has been publicised during recent United Kingdom “FISHING” Exhibitions and presented academically.

9.4 Making the Method available

9.4.1 The FISG Stability Sub Group decided that the Document, “Preparation of Guidance Information for Fishing Vessels – Instructions for Consultants”, prepared by the Wolfson Unit should be published for information and guidance. This is attached at Annex 4.

9.4.2 Fishing vessels load their cargo at sea. It should always be remembered that no matter how inherently stable the vessel may be, that if the net snags on an obstruction,

the vessel may be overwhelmed. Due regard should always ensure that the towing point is as low as possible. To save the ship, the fishing gear may have to be buoyed and jettisoned to recover later, possibly using a bigger vessel.

- 9.4.3 The attachment of fishing wire to the trawl winches should always be arranged for quick removal. The rope type of attachment is most effective and allows the wire to be parted from the winch drum quickly.

10 Notes on Maintaining Stability

- 10.1 A notice containing simple and effective methods for maintaining stability should be posted on the vessel in a prominent position, where crew members will see it.

- 10.2 The notice should include notes entitled "Simple Efforts for Maintaining Stability" or similar. These notes should be relevant to the vessel, its gear and catch handling arrangements and the fishing method. Suggestions for notes follow, and relevant ones might be selected from, or based on, this list but it is not intended to be exclusive.

- To maintain the approved stability, ensure that external doors and hatches are not left open at sea. (Those assumed to be closed in preparation of the Notice should be identified clearly here).
- Ensure that scuppers and freeing ports are open and clear of obstructions to allow water to drain quickly from the deck.
- Before attempting a heavy lift, or freeing snagging gear, inform the coastguard, bring the warp as far inboard and as low as possible, close all the doors and hatches and ensure that all crew are on deck, wearing lifejackets.
- If the maximum recommended lift from the vessel's side is exceeded, abandon the lift immediately. The position of the gear should be marked for retrieval by a larger vessel.
- The vessel may become unsafe if heavy items are moved up, heavier gear is fitted or lifting points are moved.
- Secure all gear and the catch against shifting.

11 Training

- 11.1 Skippers and crew should attend the Seafish 1-day Intermediate Stability Awareness course. Contact your nearest Seafish Approved Training Provider for details or call Seafish on 01472 252302. See MGN 411 for further details on fishermen's training.

More Information

Vessel Policy Branch
Maritime and Coastguard Agency
Bay 2/30
Spring Place
105 Commercial Road
Southampton
SO15 1EG

Tel : +44 (0) 23 8032 9139
Fax : +44 (0) 23 8032 9104
e-mail: Fishing@mcga.gov.uk

General Inquiries: infoline@mcga.gov.uk

MCA Website Address: www.mcga.gov.uk

File Ref: MS 88/1/677

Published: December 2010
Please note that all addresses and
telephone numbers are correct at time of publishing

© Crown Copyright 2010

Safer Lives, Safer Ships, Cleaner Seas

*An executive agency of the
Department for
Transport*

When printed by the MCA the material used contains a minimum 75% post-consumer waste paper

ANNEX 1

STABILITY CRITERIA (Becoming mandatory for vessels over 12m registered length and considered useful for vessels down to 7m registered length)

1. Vessels shall, for the operating conditions and circumstances set out in Appendix 1 to Annex 1 including icing allowances when applicable, and in all foreseeable operating conditions, satisfy the following stability criteria after due correction for the free surface effects of liquids in tanks:

- i) the area under the curve of righting levers (GZ curve) shall not be less than:
 - (a) 0.055 metre-radians up to an angle of 30 degrees;
 - (b) 0.090 metre-radians up to an angle of 40 degrees or such lesser angle of heel at which the lower edges of any openings in the hull, superstructures, deckhouses or companionways, being openings that cannot be closed weathertight, are immersed;
 - (c) 0.030 metre-radians between the angles of heel of 30 degrees and 40 degrees or such lesser angle as defined in (ii) above;
- ii) the righting lever (GZ) shall be at least 200 millimetres at an angle of heel equal to or greater than 30 degrees;
- iii) the maximum righting lever (GZ) shall occur at an angle of heel not less than 25 degrees;
- iv) in the upright position the transverse metacentric height (GM) shall not be less than 350 millimetres;

2. For vessels engaged on single or twin boom fishing the values of dynamic stability, righting lever and metacentric height given in sections 1 i), ii) and iv) respectively shall be increased by 20%.

LIGHTSHIP PARTICULARS

3. The vessel's lightship particulars shall be determined by inclining on completion of building to the satisfaction of the Certifying Authority.

4. Weight growth should be monitored carefully and the vessel's lightship details shall be verified at certificate renewal to the satisfaction of the Certifying Authority.

5. The carriage of unnecessary spare gear, stores and parts, the accumulation of debris and the cumulative effects of minor modifications over time can adversely affect the vessel's lightship weight and centre of gravity. Attention shall be made to limiting these effects if lightship growth and the possibility of adverse effects on the vessel's stability are to be avoided.

APPENDIX 1 to ANNEX 1

INFORMATION AS TO STABILITY OF FISHING VESSELS (FOR VESSELS UP TO 15M REGISTERED LENGTH. NAVAL ARCHITECTS CONSIDER THESE CRITERIA APPROPRIATE FOR VESSELS DOWN TO 7M REGISTERED LENGTH)

The book to be kept on board the vessel pursuant to the requirements of the Code (MSN 1813 (F) - The Fishing Vessels Code of Practice for the Safety of Small Fishing Vessels), shall contain the following information:

1. A statement of the vessel's name, port of registry, official number, registration letters, principal dimensions, date and place of build, gross and net tonnage, displacement and minimum freeboard in the deepest foreseeable operating condition.
2. A profile plan of the vessel drawn to scale showing the names of all compartments, tanks, storerooms, crew accommodation spaces and the position of the mid-point of the length between perpendiculars (LBP).
3. A tabular statement of the capacities and position of the centres of gravity, longitudinally and vertically for every compartment available for the carriage of cargo, fuel, stores, domestic water, water ballast, crew and effects. The free surface function defined in paragraph 9 below shall also be included for each tank designed to carry liquid. Details of the centroid of the total internal volume of the fish-hold(s) shall be included in such information. The calculation may take into account the effect of assuming a void space between the top of the catch and the underside of the deckhead provided that under normal operating conditions, control of loading in the hold is such that the actual void space above the catch will always be equal to or greater than that assumed in such a calculation.
4. Where deck cargo and/or stores is carried by a vessel the estimated maximum weight and disposition of such deck cargo shall be included in the information in the appropriate operating conditions, and show compliance with the stability criteria set out in the Code.
5. A diagram or tabular statement shall be provided showing for a suitable range of mean draughts and at the trim stated, the following hydrostatic particulars of the vessel:
 - (i) the heights of the transverse metacentres;
 - (ii) moments to change trim one centimetre;
 - (iii) tonnes per centimetre immersion;
 - (iv) longitudinal position of the centre of flotation;
 - (v) vertical and longitudinal positions of the centre of buoyancy;
 - (vi) displacement in tonnes.

Where a vessel has a raked keel, the same datum (a horizontal line through the intersection of the hull moulded line with the vessel centreline, amidships) shall be used for the hydrostatics as employed in determining the information required in paragraph 3 above. In such cases full information shall be included in respect of the rake and dimensions of the keel and may be given in the form of a diagram. The positioning of the draft marks relative to this datum shall be included on such a diagram.

6. A diagram or table shall be provided showing cross curves of stability indicating the assumed position of the axis from which the righting levers are measured and the trim which has been assumed. Where a vessel has a raked keel a horizontal datum through the intersection of the hull moulded line with the vessel centreline, amidships, shall be used.
7. The information provided under paragraphs 5 and 6 above shall be at such a nominal trim that represents accurately the vessel in all normal operating trims. Where calculations show that there are significant numerical variations in these operating trims the information provided under paragraphs 5 and 6 above shall be repeated over such a range of trims to allow an accurate interpolation of such information at any normal operating trim.
8. Superstructure deckhouses, companionways located on the freeboard deck, including hatchway structures may be taken into account in deriving such cross-curves of stability provided that their location, integrity and means of closure will effectively contribute to the buoyancy.
9. An example shall be included in such information to show the corrections applied to the transverse metacentric height and righting levers (GZ) for the effects of the free surfaces of liquids in tanks and shall be calculated and taken into account as follows:

- (i) the metacentric height in metres shall be reduced by an amount equal to the total of the free surface functions for each tank divided by the vessel's displacement in tonnes. For each tank the free surface function is given by:

1.025 x ρ_i where ρ = specific gravity of the liquid;
 i = transverse moment of inertia of the surface

($i = \frac{LB^3}{12}$ where L=length and B=breadth of the free surface in metres)

i.e. correction = $\frac{\text{Sum of } \rho_i}{\text{Displacement}}$

- (ii) the righting lever (GZ) curves shall be corrected by either:
 - (a) adding the free surface correction calculated under (i) above to the value in metres of the calculated height of centre of gravity of the vessel above datum; or

- (b) making direct calculations of the heeling moment due to the liquid surface being inclined at the selected angle of heel where such calculations take proper account of the position of liquid surface in relation to the geometric configuration of the tank. The correction to the righting lever (GZ) at any selected angle of heel shall then be the summation of the individual heeling moments of the tanks considered, divided by the vessel's displacement.

10. A stability statement and diagram shall be provided for the usual condition of the vessel:

- (i) in the lightship condition:

the vessel shall be assumed to be empty except for liquids in machinery and in piping systems including header tanks. The weight and position of the centre of gravity of any permanent ballast or fishing gear shall be indicated;

- (ii) in each of the following circumstances so far as they may be applicable to the vessel in its foreseeable operating conditions:

- (a) on departure from port:

the vessel shall be assumed to be loaded with the necessary equipment, materials and supplies including ice, fuel, stores and water;

- (b) on arrival at fishing grounds:

as sub-paragraph (a) above but account taken of the consumption of fuel and stores;

- (c) on arrival at fishing grounds:

as sub-paragraph (b) above but the appropriate icing-up allowance as set out in paragraph 14 below shall be taken into account;

- (d) on departure from fishing grounds:

the vessel shall be assumed to be loaded with its maximum catch but account taken of the consumption of fuel and stores;

- (e) on departure from fishing grounds:

as sub-paragraph (d) above but the appropriate icing-up allowance as set out in paragraph 14 below shall be taken into account;

- (f) on departure from fishing grounds:

the vessel shall be assumed to be loaded with 20% of its maximum catch but account taken of the consumption of fuel and stores;

(g) on departure from fishing grounds:

as sub-paragraph (f) above but the appropriate icing-up allowance as set out in paragraph 14 below shall be taken into account;

(h) on arrival at port with maximum catch:

account shall be taken of the consumption of fuel and stores;

(i) on arrival at port with 20% maximum catch:

account shall be taken of the consumption of fuel and stores;

(j) if any part of the catch normally remains on deck, further statements and diagrams appertaining to that condition in all the appropriate circumstances set out in subparagraphs (d) to (i) inclusive shall be provided;

The total free surface correction for the effect of liquid in tanks shall be applied to each loading condition set out in the foregoing provisions of this paragraph. The free surface correction shall take into account the amounts of fuel, lubricating oil, feed and fresh water in the vessel in each such loading condition.

(iii) Working instructions, specifying in detail the manner in which the vessel is to be loaded and ballasted, shall be included within the Trim and Stability Manual. The instructions shall generally be based upon the conditions that are specified in paragraph (ii) above. For vessels in which no provision has been made for the carriage of deck cargo, the working instructions shall also contain the following statement:

“Provision has not been made within the vessel’s stability for deck stowage of catch.

Catch landed on deck shall be stowed below as soon as is possible and prior to landing further catch”

11. Where provision is made in a particular area of the vessel for the washing and cleaning of the catch which could lead to an accumulation of loose water a further statement and diagram shall be provided appropriate to that condition which takes into account the adverse effects of such loose water, it being assumed that:

i) the amount of loose water on deck is determined by the size and disposition of the retaining devices; and

ii) in all other respects the vessel is loaded in accordance with (d) or (f) of paragraph 10 above, whichever is the less favourable with regard to the vessel’s stability.

12. Each stability statement shall consist of:

- (i) a profile drawn to a suitable scale showing the disposition of the deadweight components;
- (ii) a tabular statement of all the components of the displacement including weights, positions of centres of gravity, transverse metacentric height corrected for free surface effects, trim and draughts;
- (iii) a diagram showing a curve of righting levers (GZ), corrected for free surface effects and derived from the cross-curves of stability, showing, if appropriate, the angle at which the lower edges of any opening which cannot be closed watertight will be immersed. The diagram shall also show the corresponding numerical values of the stability parameters defined in section 3.1.2 of the 15-24m Code (as reproduced in Annex 1 above).

13. The information provided under sub-paragraph (iii) of paragraph 12 above shall be supplemented by a graph or tabular statement showing the maximum permissible deadweight moment over a range of draughts which shall cover foreseeable operating conditions. At any given draught this maximum permissible deadweight moment value is the total vertical moment about a convenient base line, of all the component weights of the total deadweight which, at that draught, will ensure compliance with the minimum stability criteria requirements of the Code. If an allowance for the weight due to icing-up is required, this shall be taken into account by a suitable reduction in the permissible moment. Where the stability information is supplied in accordance with the requirements of this paragraph the tabular statement required in accordance with sub-paragraph 12(ii) above shall include the deadweight moment appropriate to each condition and an example shall be added to the stability information to demonstrate the assessment of the stability.

14. The icing-up allowance which represents the added weight due to ice accretion on the exposed surfaces of the hull, superstructure, deck, deckhouses and companionways shall be calculated as follows:

- (i) full icing allowance:

all exposed horizontal surfaces (decks, house tops, etc.) shall be assumed to carry an ice weight of 30 kilogrammes per square metre. The projected lateral area of the vessel above the waterline (a silhouette) shall be assumed to carry an ice weight of 15 kilogrammes per square metre. The height of the centre of gravity shall be calculated according to the heights of the respective areas and in the case of the projected lateral area the effect of sundry booms, rails, wires, etc., which will not have been included in the area calculated shall be taken into account by increasing by 5% the weight due to the lateral area and the moment of this weight by 10%. This allowance shall apply in winter (1st November to 30th April inclusive in the northern hemisphere) to vessels which operate in the following areas:

- (a) the area north of latitude 66°30'N. between longitude 10°W. and the Norwegian Coast;
- (b) the area north of latitude 63°N. between longitude 28°W. and 10°W.;

- (c) the area north of latitude 45°N. between the North American continent and longitude 28°W.;
 - (d) all sea areas north of the European, Asian and North American continents east and west of the areas defined in (a), (b) and (c) above;
 - (e) Bering and Okhotsk seas and Tatar Strait;
 - (f) South of latitude 60°S.
- (ii) Half of the full icing allowance:
- this shall be taken as one half of that calculated under sub-paragraph (i) of this paragraph and shall apply in winter to vessels which operate in all areas north of latitude 61°N. between longitude 28°W. and the Norwegian Coast and south of the areas defined as the lower limit for the full icing allowance between longitude 28°W. and the Norwegian Coast.
- 15.** Information shall be provided in respect of the assumptions made in calculating the condition of the vessel in each of the circumstances set out in paragraph 10 above for the following:
- (i) duration of the voyage in terms of days spent in reaching the fishing grounds, on the grounds and returning to port;
 - (ii) the weight and disposition of the ice in the hold at departure from port including the heights of stowage;
 - (iii) consumption rates during the voyage for fuel, water, stores and other consumables;
 - (iv) ratio by weight of the ice packed with the catch in the fish hold;
 - (v) melting rates for each part of the voyage of the ice packed with the catch and the ice remaining unused in the hold.
- 16.** A copy of a report of an inclining test of the vessel and the derivation there from of the lightship particulars shall be provided.
- 17.** A statement shall be given by or on behalf of the owner of the vessel that the statements and diagrams supplied with respect to the operating conditions set out in paragraph 10 above are based on the worst foreseeable service conditions in respect of the weights and disposition of fish carried in the hold or on deck, ice in the hold, fuel, water and other consumables.

ANNEX 2 – THE CRITERIA FOR SMALL (UNDER 24M) COMMERCIAL VESSELS

A vessel should be tested in the fully loaded conditions (which should correspond to the freeboard assigned) to ascertain the angle of heel and the position of the waterline which results when all persons which the vessel is to be certificated to carry are assembled along one side of the vessel. (The helmsman may be assumed to be at the helm.) Each person may be substituted by a mass of 75kg for the purpose of the test. Please note that 75kg may be increased in the foreseeable future.

The vessel will be judged to have an acceptable standard of stability if the test shows that:-

- .1 the angle of heel does not exceed 7 degrees; and
- .2 in the case of a vessel with a watertight weather deck extending from stem to stern, as described in Section 4.1.1 (of MGN 280, see below), the freeboard to deck is not less than 75mm at any point.
- .3 The angle of heel may exceed 7 degrees, but should not exceed 10 degrees, if the freeboard in the heeled condition is in accordance with that required by Section 12 (of MGN 280, see below) in the upright condition.

This method considers areas of operation from the point of view of distances from port.

MGN 280 states

4. Construction and Structural Strength

4.1 General Requirements

4.1.1 A vessel which operates in Area Category 0, 1, or 2 should be fitted with a watertight weather deck over the length of the vessel, satisfying the requirements of Section 4.3.1, and be of adequate structural strength to withstand the sea and weather conditions likely to be encountered in the intended area of operation.

4.1.2 A vessel which is not fitted with a watertight weather deck in accordance with Section 4.1.1 should normally be restricted to Area Category 3, 4, 5 or 6 and be provided with adequate reserves of buoyancy and stability for the vessel with its full complement of persons to survive the consequences of swamping. An open boat should normally be restricted to service in area categories 4, 5 and 6. A sailing vessel which is not fitted with a watertight weather deck should be limited to Area Category 6.

11.3.9 Permitted areas of operation (not presently applying to fishing vessels)

Permitted Area of Operation	MCA Code Category	ISO 12217 Design Category
Unrestricted	0	A
Up to 150 miles from a safe haven	1	A
Up to 60 miles from a safe haven	2	B
Up to 20 miles from a safe haven	3	B
Up to 20 miles from a safe haven in favourable weather and daylight	4	C
Up to 20 miles from a nominated departure point in favourable weather and daylight	5	C
Up to 3 miles from a nominated departure point in favourable weather and daylight	6	C

12.2 Motor Vessels

12.2.1 General

Section 12.2.2 defines the requirements for minimum freeboard for a motor vessel whose stability has not been assessed using ISO 12217 'Small craft - Stability and buoyancy assessment and categorisation' Part 1. Section 12.2.3 defines how and when the freeboard mark, and deck line, should be applied. Requirements for an inflatable boat or boat fitted with a buoyant collar, not requiring an approved Stability Information Booklet, are contained within Section 12.2.4.

It should be noted that for vessels whose freeboard is not determined using Section 12.2.2.2, and are not provided with an approved stability information booklet, although requirements exist for minimum freeboard, such vessels are not required to be marked with a freeboard mark. In such cases the loading of the vessel is governed the maximum permissible weight, in accordance with Section 11, as identified on the vessel's certificate.

12.2.2 Minimum freeboard

The freeboard , for a motor vessel whose stability has not been assessed in conjunction with Sections 11.3.8 or 11.4.5, should be not less than that determined by the following requirements:-

12.2.2.1 Vessels which carry cargo or a combination of passengers and cargo for which the cargo element does not exceed 1000kg.

A vessel, other than an inflatable or rigid inflatable boat covered by Section 12.2.4, when fully loaded with cargo and non-cargo deadweight items certificated to be carried (each person taken as 75kg) should be upright and:-

- .1 in the case of a vessel with a continuous watertight weather deck in accordance with Section 4.3.1.1, which is neither stepped or recessed or raised, have a freeboard measured down from the lowest point of the weather deck of not less than 300 mm for vessels of 7 metres in length or under and not less than 750 mm for vessels of 18 metres in length or over. For a vessel of intermediate length the freeboard should be determined by linear interpolation;
- .2 in the case of a vessel with a continuous watertight weather deck in accordance with Section 4.3.1.2, which may be stepped, recessed, or raised, have a freeboard measured down from the lowest point of the weather deck, of not less than 200 mm for vessels of 7 metres in length or under and not less than 400 mm for vessels of 18 metres in length or over. For a vessel of intermediate length the freeboard should be determined by linear interpolation. The raised portion(s) of the watertight weather deck should extend across the full breadth of the vessel and the average freeboard over the length of the vessel should comply with .1 above for a vessel with a continuous watertight weather deck;
- .3 in the case of an open boat, have a clear height of side (i.e. the distance between the waterline and the lowest point of the gunwale*) of not less than 400mm for vessels 7 metres in length or under and not less than 800mm for vessels 18 metres in length or over. For a vessel of

intermediate length the clear height should be determined by linear interpolation;

*(The clear height of the side should be measured to the top of the gunwale or capping or to the top of the wash strake if one is fitted above the capping.)

12.2.2.2 Vessels which carry cargo or a combination of passengers and cargo for which the cargo element exceeds 1000kg, or those that cannot comply with Section 12.2.2.1.

Freeboard should be assigned in accordance with the Merchant Shipping (Load Line) Regulations 1998.

Such vessels should have a scale of draught marks marked clearly at the bow and stern.

12.2.2.3 A vessel required to be provided with an approved Stability Information Booklet should be assigned a freeboard which corresponds to the draught of the vessel in sea water when fully loaded (each person taken as 75kg), but which in no case should be less than the freeboard required by Section 12.2.2.1 or 12.2.2.2, nor that corresponding to the scantling draught.

12.2.3 Freeboard mark and loading

12.2.3.1 A vessel assigned a freeboard in accordance with Section 12.2.2.2 should be marked with a freeboard mark in accordance with the Merchant Shipping (Load Line) Regulations 1998 and have a scale of draught marks marked clearly at the bow and stern, on both sides of the vessel. The longitudinal position of the draught marks, relative to the longitudinal datum for the hydrostatic data, should be recorded in the Stability Information Booklet, where provided.

Where it is considered that the addition of a scale of draught marks is neither practicable nor meaningful, for example, due to restricted loading variations, application for special consideration should be made to the Administration.

Additionally, where the line of the deck is not immediately discernable, a vessel should be provided with a deck line. The deck line and freeboard mark should be permanent and painted on a contrasting background.

The freeboard mark shall consist of a ring 300 millimetres in outside diameter and 25 millimetres wide, intersected by a horizontal line 450 millimetres long and 25 millimetres wide the upper edge of which passes through the centre of the ring. The top of the intersecting line should be positioned at the waterline corresponding to the assigned freeboard to deck edge at amidships.

No mark should be applied for fresh water allowance.

The assigning letter marking on the bar of the ring and bar should be D on the left and T on the right when the MCA is the Certifying Authority. In the case of any other Certifying Authority, the assigning letters should be U on the left and K on the right.

12.2.3.2 The freeboard mark for a vessel required to be provided with an approved Stability Information Booklet, other than a vessel complying with Section 12.2.3.1 should be a bar of 300mm in length and 25mm in depth.

The marking should be permanent and painted black on a light background or in white or yellow on a dark background. (No assigning letter marking should be placed on the bar marking.)

The top of the mark should be positioned at the waterline corresponding to the draught referred to in Section 12.2.2.3, at amidships.

Additionally, where the line of the deck is not immediately discernable, a vessel should be provided with a deck line. The deck-line shall be marked amidships on each side of the ship so as to indicate the position of the freeboard deck. The mark need not be of contrasting colour to the surrounding hull.

Where the design of the vessel, or other circumstances, render it impracticable to mark the deck line, the Certifying Authority may direct that it be marked by reference to another fixed point as near as practicable to the position described above.

12.2.3.3

A vessel should not operate in a condition which will result in its freeboard marks being totally submerged when it is at rest and upright in calm sea water.

ANNEX 3 – SMALL PASSENGER VESSEL HEEL TEST

The Heeling Test and Freeboard Measurements

1.0 Condition of Ship:

The heeling test shall be conducted with fuel and water tanks full. If this is not possible, extra weights shall be added at approximately the same longitudinal centre of gravity to simulate the additional fuel or water required. Any ballast present on the ship shall be recorded for reference at future stability verifications. Photographs of the ship should be taken to aid recording of the condition of the ship during the test.

2.0 Weights:

Any form of weights may be used where the mass is known or can be checked using a suitable weighing device. Care shall be taken when using sandbags or similar where moisture ingress may have a significant effect on their weight. The use of people for performing heeling tests is not permitted due to safety and accuracy considerations.

3.0 Movement of weights:

The total heeling moment of WB/12 shall be imposed in 3 shifts of approximately WB/36, with the angle of heel being recorded at each stage. This staged heeling allows for subsequent analysis in borderline cases, helps avoid experimental errors and reduces the risk of excessive heel angles being achieved on newly considered ships. The process shall be performed for shifts both to port and to starboard. It is not necessary to utilise all the weights on board to produce the required heeling moment; the amount of weight used to provide the heeling moment will depend upon the distance it is able to be shifted. The type of weights, distribution and movement shall be agreed with the owner or representative prior to the test.

4.0 Measurement of Angle of Heel:

The angle of heel may be measured using battens pre-marked with freeboard corresponding to 5° and 7° of heel. In most cases, however, it is considered easier to calculate the angle of heel by use of a pendulum, calibrated inclinometer, water tube or by freeboard measurements. The angles of heel shall be measured by two separate methods where practicable to provide a means of verification. For example, this could be two pendulums (forward and aft), a pendulum and freeboard measurements or pendulum and inclinometer. When a pendulum is used to measure the heel angle the pendulum shall ideally be of sufficient length to produce a deflection of 35 mm for each weight shift. The angle of heel shall be recorded. Care shall be taken to ensure the ship is floating freely and avoid the influence of wash from passing ships, wind heeling and mooring line tension on heel angle measurements.

5.0 Assumed Centre of Gravity of Fish Landed on Deck:

The vertical centre of gravity of fish landed shall be assumed to be 500 mm above the deck.

6.0 Heeling Moment:

The two thirds – one third weight distribution equates to the standard heeling moment of WB/12. W is the weight of landed fish and B is the extreme breadth to the outside of the hull plating (excluding any fendering or rubbing strakes). This heeling moment may be applied using any weight and shift distance combination, provided it produces the required heeling moment (heeling moment = weight x distance moved).

7.0 Freeboard measurements:

7.1 Loaded freeboard measurements shall be taken at the heeling test with all weights onboard to represent the maximum capacity of fish in the fully loaded condition. Freeboard measurements shall be taken at positions forward, aft and amidships; with the location of the measurement points being recorded for future reference. Freeboard measurements shall generally be taken to the deck edge at side; any exception to this shall be noted to avoid any misinterpretation. The minimum freeboard and its location shall also be recorded. The mean loaded freeboard shall not be less than the minimum freeboard permitted for the ship. The minimum freeboard for ships of waterline length 6 m or less is 380mm. The minimum freeboard for ships with a waterline length of 18.3 m or more is 760mm. For intermediate lengths the minimum freeboard shall be calculated by linear interpolation.

7.2 The mean loaded freeboard measured at the amidships point from the deckline shall be the loaded freeboard of the ship and shall be the freeboard to be marked. The freeboard shall be the distance between the position of assumed minimum freeboard to the waterline.

7.3 Ships may take the minimum freeboard to the lowest point of downflooding rather than to the deck edge, providing that the upstands or superstructure raising the point of downflooding above the level of the deck are of a similar standard of watertight structural efficiency to the ship's topsides.

7.4 In the case of ships heeling less than 7° but not meeting the minimum freeboard requirement, a reduced minimum freeboard may be accepted provided that the actual freeboard in the heel test condition is not less than the residual freeboard would have been, had the prescribed minimum freeboard criteria been complied with and the ship had heeled to the full 7°.

7.5 At the heeling test, freeboard measurements shall also be taken in the 'light' condition with no landed fish weight onboard. This may be done before or after the heeling test is conducted. The tank states shall be as per the heeling test condition (full or compensated using weights). Freeboard measurements shall be taken forward, aft and amidships; with the location of the measurement points being recorded for future reference. Details of any bar stock, changes in normal furniture and equipment, and number of personnel onboard shall also be noted.

8.0 Subsequent Stability Verifications:

The ship shall be placed in the same "light" condition as recorded. The upright freeboards shall be re-recorded and compared with the previous values. Should the result be the same then the ship is deemed to be unchanged and the stability is accepted for a further five years. Due to measurement errors freeboards are considered unchanged if within 2 cm of the original figures at the bow and stern and 1 cm at the amidships measuring point. Slightly larger figures may be accepted if reasons for the change can be accounted for. However, if the change in freeboard exceeds these margins and cannot be accounted for (thereby indicating an increase in the lightship displacement) then the heeling test must be undertaken.

ANNEX 4

THE APPROXIMATE ROLL METHOD

Method

Measure the beam of the vessel in metres (eg 4.6m).

Induce the vessel to roll and time 5 complete rolls (A complete roll is from one side to the other and back to the beginning). After the initial force has been applied, the vessel should be allowed to roll freely. Times should be recorded as accurately as possible. It is also more accurate to take the time from the upright rather than the maximum roll angle, due to the speed of movement at that position.

Repeat this exercise twice more. From the fifteen rolls determine the average time of one complete roll.

If the time for one roll in seconds is greater than the beam in metres, the vessel can be said to be tender. Similarly if the time in seconds is less than “the figure” for beam, she may be said to be stiff.

Figures should be retained for future comparison and ideally a photograph taken and dated at the time of the roll.

ANNEX 5 – THE WOLFSON METHOD

THIS ANNEX REPRODUCES THE DOCUMENT “PREPARATION OF GUIDANCE INFORMATION FOR FISHING VESSELS” ISSUED BY THE WOLFSON UNIT

THE WOLFSON METHOD HAS BEEN DEVELOPED FROM A MCA RESEARCH PROJECT. SKIPPERS AND OWNERS MAY FIND IT USEFUL.

For additional guidance to calculate the size of freeboard marks for vessels without stability data and further examples of stability notices see Appendix 1 to Annex 4.

CONTENTS

1. Introduction
2. Calculation of the Safety Zone Definitions
3. Calculation of the Critical Loading and Lifting Cases
4. Information to be Presented
5. Calculation Methods for Vessels with Full Stability Analysis
6. Accuracy of Data
7. Vessel Illustrations
8. Notes on Maintaining Stability
9. Photograph
10. Heeling Test
11. Instrumentation

1. INTRODUCTION

This document summarises the methods used to prepare Stability Notices for fishing vessels. It is based on the recommendations of Research Projects 559 and 560 carried out by the Wolfson Unit of Southampton University. The researchers recommend that each vessel display a Stability Notice in a prominent position in the wheelhouse. This notice would provide guidance on how certain loading or lifting operations will reduce the safety of the vessel, and on the limiting seastates in which such operations should be conducted. Three safety zones are defined, and assigned the colours green, amber and red on the Stability Notice to represent the relative levels of safety.

Figure 1 presents a simplified summary of the proposals for stability assessment and documentation for fishing vessels, depending on their age, size, and whether they are equipped for towing or lifting. Vessels over 15m LOA are required to carry stability books. For these vessels, and any smaller vessels that have a full stability analysis, the method of providing safety guidance is based on an assessment of the residual stability when loaded or lifting. For vessels with no stability information the guidance is based on the residual freeboard when loaded or lifting.

Figure 1. Flow Chart of the system of assessment and guidance for fishing vessels

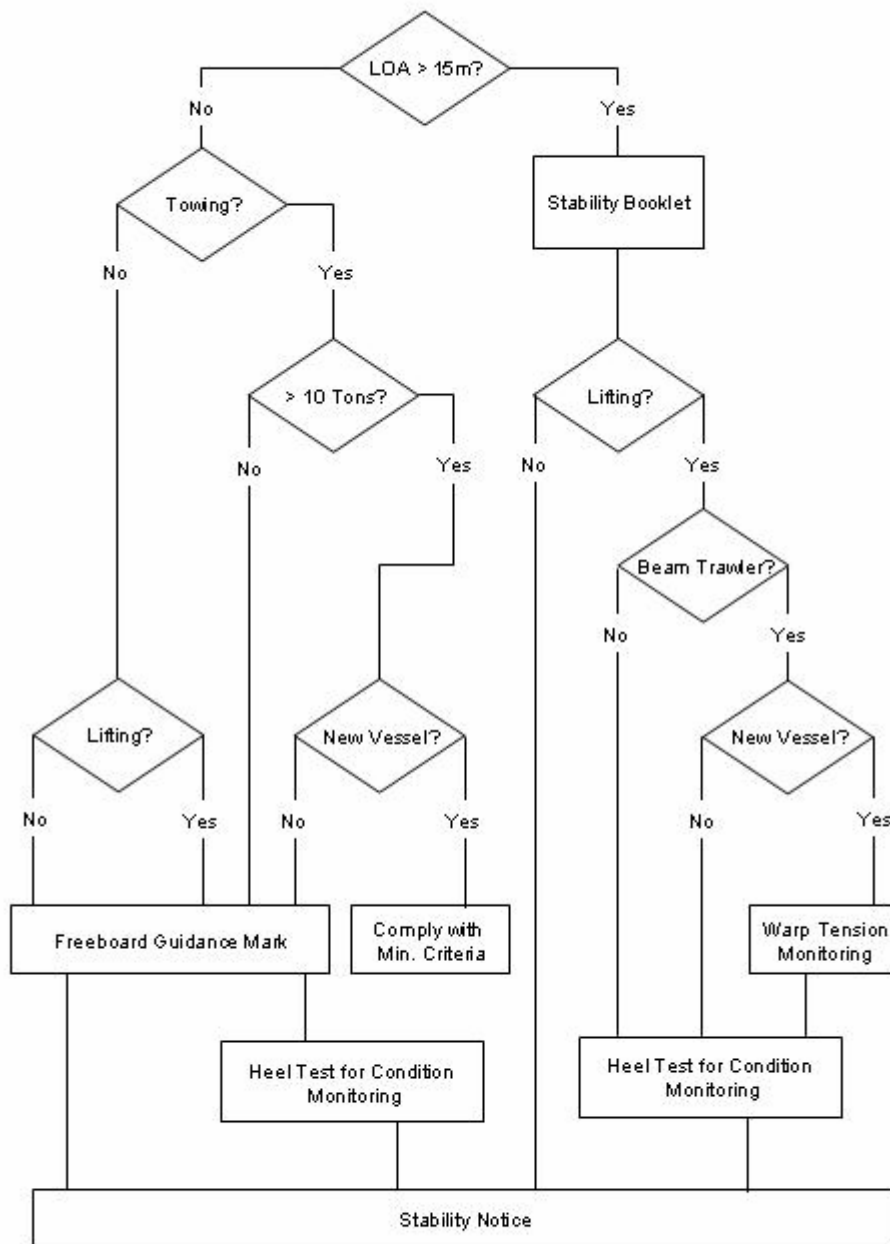

2. CALCULATION OF THE SAFETY ZONE DEFINITIONS

Three safety zones are defined:

Green: "Safe" in all but extreme sea states

Amber: "Low level of safety" and should be restricted to low sea states

Red: "Unsafe, and danger of capsize" unless restricted to calm conditions and with extreme Caution

The safety of a vessel is dependent on its size and stability in relation to the sea state. For a vessel of a given size and stability, the lowest, or critical, sea state that could result in capsize can be estimated. The safety zone boundaries are defined by the significant waves heights $H_{s_{\text{amber}}}$ and $H_{s_{\text{red}}}$ as follows:

$$\text{Green/amber boundary: } H_{s_{\text{amber}}} = \sqrt{1 + 0.4LOA} - 1$$

$$\text{Amber/red boundary: } H_{s_{\text{red}}} = (H_{s_{\text{amber}}})/2$$

The loading and lifting cases that are most likely to occur, and which reduce the stability to these values, should be presented on the Stability Notice.

3. CALCULATION OF THE CRITICAL LOADING AND LIFTING CASES

3.1 Minimum stability for vessels with full stability analysis:

The critical loading or lifting cases that correspond to the green/amber and amber/red safety zone boundaries are defined by the residual range of stability and righting moment:

$$\text{Green/amber boundary: } \text{Range } \sqrt{RM_{\text{max}}} = 20B(H_{s_{\text{amber}}})$$

$$\text{Amber/red boundary zone: } \text{Range } \sqrt{RM_{\text{max}}} = 20B(H_{s_{\text{red}}})$$

Where
Range is the residual range of positive stability in degrees
RMmax is the maximum residual righting moment, having taken account of any heeling moments due to offset weights, lifting or wind, in tonne.metres
B is the maximum beam in metres

The potential for significant downflooding should be considered, and the stability curve terminated at the downflooding angle.

3.2 Minimum freeboard for vessels with no stability data:

For vessels with no stability data, the critical loading or lifting cases that correspond to the safety zone boundaries are defined by the residual minimum freeboard. That is the minimum height of the lowest part of the weather deck above the waterline. The only vessel dimensions required are the overall length and beam.

Decked Vessels

$$\text{Green/amber zone boundary: } \text{Min.Freeboard} = \frac{B}{L} (H_{s_{\text{amber}}})$$

$$\text{Amber/Red zone boundary: } \text{Min.Freeboard} = \frac{B}{L} (H_{s_{\text{red}}})$$

Undecked Vessels

Because of the increased risk of swamping by wave action, no green safety zone is defined for undecked vessels.

$$\text{Amber/red zone boundary} \quad \text{Min.Freeboard} = \frac{2.6B}{L} (H_{s_{\text{red}}})$$

4. INFORMATION TO BE PRESENTED

The following information should be included for each case presented on the Stability Notice:-

- The significant wave height of the maximum recommended sea state for the amber and red zones.
- The range of minimum residual freeboards appropriate for each zone.
- For loading cases, definitions of the critical loadings that are identifiable on board.
- For lifting cases, the range of heel angles appropriate to each zone, and, or
- Where a load cell is fitted, the range of lifting loads appropriate to each zone.

5. CALCULATION METHODS FOR VESSELS WITH FULL STABILITY ANALYSIS

5.1 Loading cases

It is preferable for consultants to use software that automates the calculation to such a degree that it can be based on all of the standard loading conditions, in the same way as a maximum allowable KG calculation might be performed. It should be possible then to identify the worst conditions as those with the lowest loads at the safety zone boundaries.

If it is not practical to consider all loading conditions, care should be taken to ensure that the worst condition is selected. The condition with the lowest stability might have the highest freeboard, and it is not always possible to identify by inspection which condition might have the lowest level of safety when additional loads are applied, particularly when lifting. Conventional assessment does not consider righting moment, and the condition with the lowest GZ values might not be the condition with the lowest righting moment.

It is necessary to consider all possible loading cases that might be hazardous to the vessel. These might include overloading holds, filling hoppers, holding catch on deck, and lifting from all blocks with capacity. Example lifting cases for a beam trawler are presented in Figure 3.

It may be necessary to consider combinations of loading and lifting, particularly where it is likely that a combination of the two will take place, or where normal operations will result in very large variations of loading condition and stability. Examples of possible presentations are shown in Figure 4 and Figure 5. Figure 3 is preferred because it identifies the increased danger of lifting when adversely loaded.

It is anticipated that, in most cases, such a study will provide redundant information, and every effort should be made to simplify the Stability Notice by minimising the number of loading cases presented. Redundant information will occur if maximum possible loads or lifts do not result in a reduction of stability to the amber zone. Simplification of the information may also be

possible where different loading cases have similar critical loads, and therefore may be groups together with a common value.

6. ACCURACY OF DATA

When operating with minimal stability, small changes to the loading case can result in large changes to the predicted value of the critical seastate. This is because the range of stability, which is the dominant parameter, can reduce rapidly, particularly with asymmetric loading, or lifting, cases. Whilst accuracy of the calculations is necessary to ensure that reliable information is provided, it should be borne in mind that the information is based on estimates of vulnerability which depend on many variables. This method does not offer a precise prediction of capsizing, and so presentation of information to a high degree of accuracy is not appropriate.

Calculated values should be rounded to levels that are reasonable, bearing in mind the instrumentation or observations to which they relate. As a general rule of thumb, rounding of values to within 10% should be appropriate. The following examples are offered for guidance:

Parameter	Units	Decimal Places
Seastate	metres	0 or 1
Load	tonnes	0 or 1
Freeboard	metres	1
Heel angle	degrees	0

7. VESSEL ILLUSTRATIONS

Simple illustrations should be incorporated to clarify the nature of the information provided. These may be simple diagrammatic line drawings of the profile or cross section of the vessel, as appropriate to identify each loading case considered. Whilst it is not necessary for these to be scale drawings of the vessel, the fishermen will be more likely to relate to them if they bear a close resemblance to the vessel.

8. NOTES ON MAINTAINING STABILITY

The notice should include notes entitled "Simple Efforts for Maintaining Stability" or similar. These notes should be relevant to the vessel, its gear and catch handling arrangements and the fishing method. Suggestions for notes follow, and relevant ones might be selected from, or based on, this list but it is not intended to be exclusive.

- To maintain the approved stability, ensure that external doors and hatches are not left open at sea. (Those assumed to be closed in preparation of the Notice should be identified clearly here).
- Ensure that scuppers and freeing ports are open and clear of obstructions to allow water to drain quickly from the deck.
- Before attempting a heavy lift, or freeing snagging gear, inform the Coastguard, bring the warp as far inboard and as low as possible, close all the doors and hatches and ensure that all crew are on deck, wearing lifejackets.
- If the maximum recommended lift from the vessel's side is exceeded, abandon the lift immediately. The position of the gear should be marked for retrieval by a larger vessel.
- The vessel may become unsafe if heavy items are moved up, heavier gear is fitted or lifting points are moved.
- Secure all gear and the catch against shifting.

9. PHOTOGRAPH

A photograph of the full profile of the vessel should be included, and labelled with the date it was taken. The date should correspond with the preparation of the Stability Notice.

10. FREEBOARD MARKS

The researchers propose that Freeboard marks are applied on all vessels for which the guidance information has been based on minimum freeboards rather than on a full stability analysis.

The marks should be placed on both sides of the vessel. In selecting the location, the most likely reason for reduced freeboard should be borne in mind. If a large load is added well forward of aft, or is lifted from a point that is well forward of aft, the load might induce a large trim, resulting in the minimum freeboard being at a different longitudinal location compared with the upright case. While the research is based on the minimum freeboard it is not possible to calculate the exact location of minimum freeboard because freeboard might be reduced with a number of different load configurations. A consistently useful position is 25% LOA (forward from the aft end i.e. 75% abaft the fore end).

The marks should be applied in a colour that contrasts with the surrounding topsides.

The size and shape of the marks should conform to the dimensions shown in Figure 2.

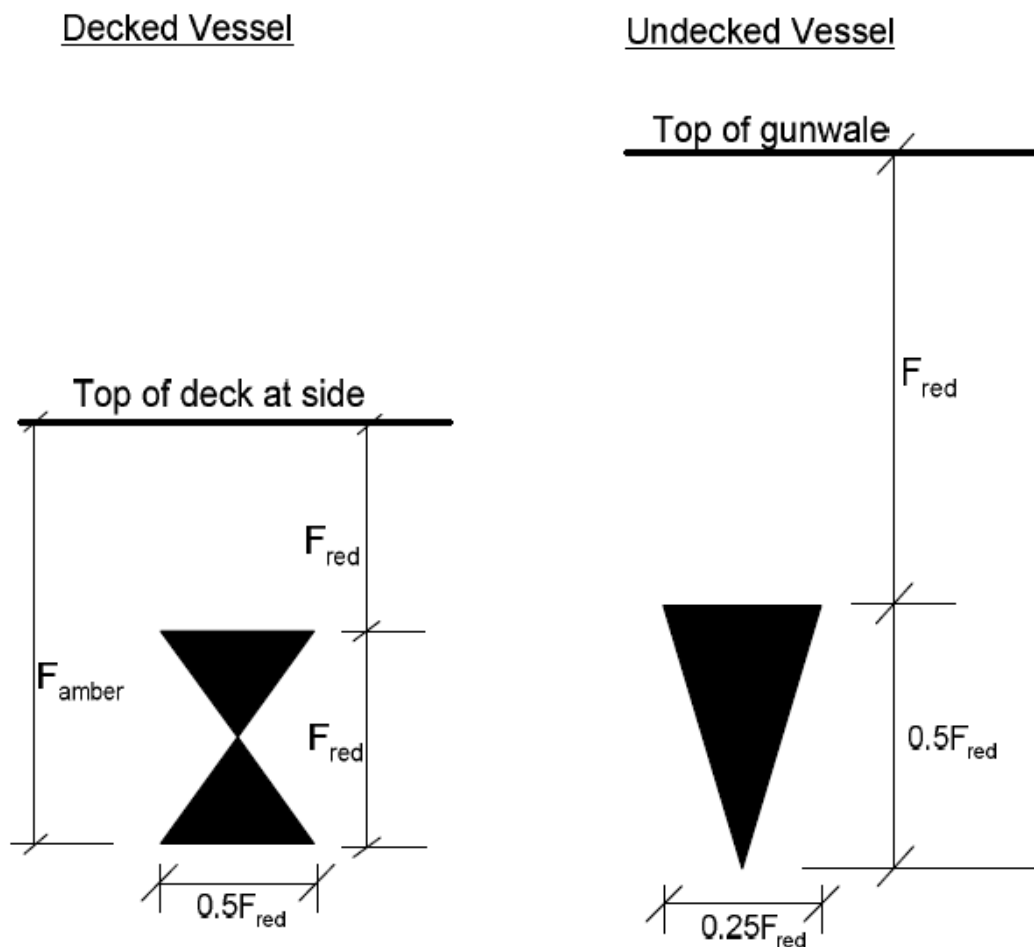

11. HEELING TEST

The aim of the heeling test is to indicate whether significant modifications have been made to the vessel, its gear or gear handling arrangement. Significant modifications will require revision of the Stability Notice, and perhaps the stability booklet, in which case an inclining experiment will be required.

It is preferable to use components of the actual gear, lifted from a block in its highest or furthest outboard location, to give a measurable heel angle. Such a heeling test will relate directly to the fishing operation. More importantly, it will enable the fishermen to relate their operation to their vessels stability.

For a beam trawler, this is straightforward because one beam trawl from the horizontal derrick on one side, typically, will result in a heel angle of about 10 degrees. Any increase in the trawl weight or derrick length, or decrease in the stability, will result in a larger angle. Small differences are not important because they are inevitable with wear of the gear and small variations in the loading condition. It is not considered necessary to specify the vessel loading condition precisely but some level of repeatability in the righting moment is required. Because the righting moment is proportional to the product of displacement and GM, and both tend to increase with increased tank contents, variations of around 30% are to be expected between the depart port and arrival conditions. A convenient loading condition, such as a nominal depart port condition, should be selected. Empty hold, no ice and full tanks might be a practical condition for example. Preferably this should be agreed by the skipper and surveyor well in advance of the first test. The vessel should be trimmed upright by movement of loose gear or tank contents, or the heel test may be conducted on both sides, and a mean value recorded to eliminate the effects of any initial list.

The heel angle can be measured with a simple inclinometer, provided it enables a suitable level of accuracy. If the heeling test is conducted at the same time as an inclining experiment it may be convenient to use a damped pendulum. If the heel angle is significantly greater than that recorded when the Stability Notice or stability booklet were prepared, it will be necessary to determine the reason for the increase. It is suggested that a suitable criterion for acceptability, or margin of variation, in the measured heel angle is within 10% of the original value. It should be noted that such an increase in the heel angle may be gradual, so that successive heeling tests might be within the acceptable margin of each other, while the cumulative effect results in an increase from the original that is unacceptable.

There are three possible reasons for an increase in heel angle, and each one that applies will require appropriate revision of the stability documents for the vessel. In some cases a combination of reasons will apply.

Reason for increase in heel angle	Revisions required
Increased weight of fishing gear	Stability booklet – gear details and loading conditions
Longer derricks, or a higher lifting point	Stability booklet – derrick details Stability Notice – maximum recommended lifting loads
Reduced vessel stability	Conduct new inclining experiment Stability booklet – loading conditions Stability Notice – all data

12. INSTRUMENTATION

12.1 Load cells and warp tension monitoring systems

Where load cells are fitted to the lifting blocks, or the vessel has warp tension monitoring equipment, the lifting loads corresponding to the safety zone boundaries should be presented on the Stability Notice, unless they exceed the capacity of the lifting equipment.

12.2 Inclinerometers

An inclinometer enables the heel angle due to lifting to be monitored, and compared with heel angle information on the Stability Notice. Whilst it is unlikely to be as accurate as lifting load monitoring instrumentation, it has the advantage that measurement of heel angle incorporates any reduction in the stability of the vessel or movement of the lifting point. If the stability has been adversely affected by unreported modifications to the vessel, poor loading or flooding, the heel angle resulting from a given moment will be greater than predicted in the stability calculations conducted when preparing the Stability Notice. If the lifting point has been relocated, the lifting guidance presented on the Stability Notice may be invalid, but the heel angle is unlikely to be affected.

Inclinometers come in a variety of forms and levels of complexity. It would be advantageous to have a display with an efficient averaging system to eliminate the roll motion and present the mean heel angle, but even a simple device will provide valuable information. A bead in a fluid filled tube is perhaps the simplest type, obtainable at yacht chandlers for a few pounds, Whilst it will not give a steady reading on a rolling vessel, the observer can obtain a mean reading with reasonable accuracy, and such a device would enable the fishermen to become familiar with the feel of their vessel at different heel angles. They would then be better able to relate to the information on the Stability Notice.

A permanent inclinometer would facilitate conducting a heel test to monitor the stability.

Because simple instruments are cheap, readily available, and trivial to fit, the researchers propose that all fishing vessels should be equipped with some form of inclinometer, mounted athwartships to measure the heel angle.

Figure 3 Example Stability Notice for a 24m beam trawler

STABILITY NOTICE			
BONNIE LASS AB123 LOA: 24M Owner; John Fisher	Lifting Guidance		
	Good margin of Stability	Low level of safety	Danger of Capsize
 Double lift from raised derricks	Less than 4.5 tonnes each side	4.5 – 7.5 each side	More than 7.5 tonnes each side
 Lift from single lowered derrick	Less than 5.5 tonnes Deck edge above waterline Heel angle less than 12°	5.5 - 7.5 tonnes Deck edge immersion less than 20 cm Heel angle 12° - 17°	More than 7.5 tonnes Deck edge immersion more than 20 cm Heel angle more than 17°
 Lifting from bulwark	Less than 10 tonnes Deck edge above waterline Heel angle less than 10°	10 - 15 tonnes Deck edge immersion less than 20 cm Heel angle 10° - 16°	More than 15 tonnes Deck edge immersion more than 20 cm Heel angle more than 16°
<u>Simple efforts for maintaining stability</u>			
<ul style="list-style-type: none"> • Before attempting a heavy lift the coastguard should be informed, the warp should be brought to the vessel's side, all hatches should be closed and all crew should be on deck, wearing lifejackets. • If maximum recommended lift from the bulwark is exceeded the list must be abandoned immediately. Position of gear should be marked and noted for retrieval by a larger vessel. • Ensure scuppers are open and clear of obstructions to allow water to drain from the deck. • Vessel may become unsafe if longer derricks or larger beams are fitted. 			
<u>Heel Monitoring Test</u>			
This vessel heeled 9 degrees with starboard gear on lowered derrick, port derrick topped and port gear on deck. The residual freeboard was 33cm. 5 February 2006.			
<div style="border: 1px solid black; padding: 20px; width: fit-content; margin: 0 auto;"> Photograph of Vessel Dated 5th February 2006 </div>			

Figure 4 Example of the loading guidance for the Stability Notice on a pelagic trawler. Preferred format for combined lifting and loading

STABILITY NOTICE				
BONNIE LASS AB456 LOA: 32M Owner: Mike Fisher				
		Loading bulk fish in hold		
		Less than half depth of hold	$\frac{1}{2}$ - $\frac{3}{4}$ depth of hold	More than $\frac{3}{4}$ depth of hold
 Lifting from towing blocks	Less than 6 tonnes	Min freeboard at least 40cm	Min freeboard 20-40cm Max seastate 3.5m	Min freeboard Less than 20cm Max seastate 1.5m
	6 – 10 tonnes	Min freeboard 20-40cm Max seastate 3.5m	Min freeboard Less than 20cm Max seastate 1.5m	
	More than 10 tonnes	Min freeboard Less than 20cm Max seastate 1.5m		
 Lifting from derrick	Less than 2 tonnes	Min freeboard at least 40cm	Min freeboard 20-40cm Max seastate 3.5m	Min freeboard Less than 20cm Max seastate 1.5m
	2 -4 tonnes	Min freeboard 20-40cm Max seastate 3.5m	Min freeboard Less than 20cm Max seastate 1.5m	
	More than 4 tonnes	Min freeboard Less than 20cm Max seastate 1.5m		
		Good margin of safety	Low level of safety	Danger of capsizing

Figure 5 Example of the loading guidance for the Stability Notice on a pelagic trawler. Alternative format for independent loading and lifting.

STABILITY NOTICE			
BONNIE LASS AB456 LOA: 32M Owner: Mike Fisher	Loading and Lifting Guidance		
	Good margin of Stability	Low level of safety	Danger of Capsize
		Max recommended seastate 3.5 metres	Max recommended seastate 1.5 metres
 Loading bulk fish in hold	Less than half depth of hold Min freeboard at least 50cm	$\frac{1}{2}$ - $\frac{3}{4}$ depth of hold Min freeboard 25-50cm	More than $\frac{3}{4}$ depth of hold Min freeboard less than 25cm
 Lifting from derrick	Less than 2 tonnes Min freeboard at least 40cm	2 – 4 tonnes Min freeboard 20-40cm	More than 4 tonnes Min freeboard Less than 20cm
 Lifting from towing blocks	Less than 6 tonnes Min freeboard at least 30cm	6 – 10 tonnes Min freeboard 15 – 30 cm	More than 10 tonnes Min freeboard Less than 15cm

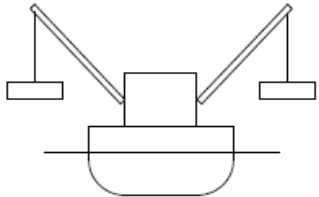
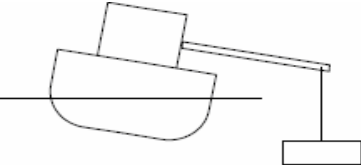
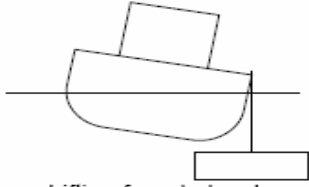
APPENDIX 1 TO ANNEX 4

STEP-BY-STEP GUIDE TO CALCULATE SIZE OF FREEBOARD MARKS FOR VESSELS WITHOUT STABILITY DATA

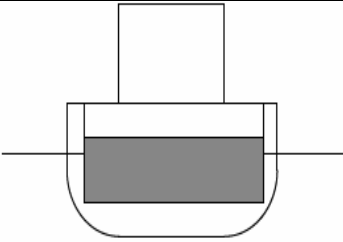
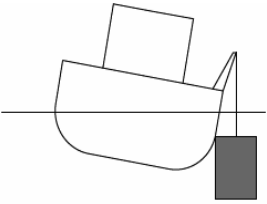
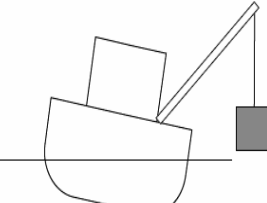
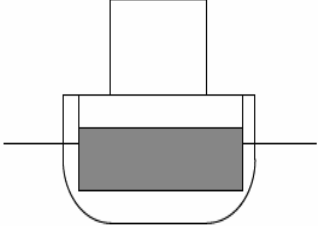
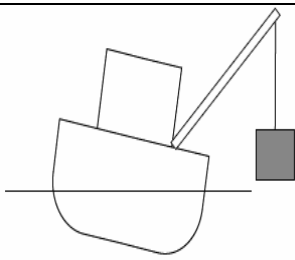
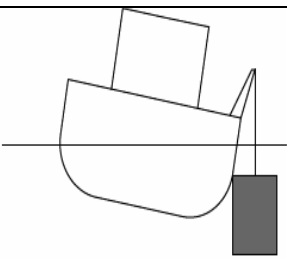
To calculate the size of the marks for a vessel, Beam (B) and Length Overall (LOA) of the vessel is needed. The shape and size of the mark varies between Decked and Undecked vessels.

The safety zone boundaries are based on Significant Wave Heights, $H_{s_{amber}}$ and $H_{s_{red}}$ which need to be calculated in the first instance using the equations below.

$$H_{s_{amber}} \text{ (metres)} = \sqrt{(1 + 0.4 \times LOA)} - 1$$

$$H_{s_{red}} \text{ (metres)} = (H_{s_{amber}})/2$$

Once this has been calculated, the green/amber boundary (F_{amber}) and the amber/red boundary (F_{red}) of the mark need to be calculated as shown below, which will then indicate the size of the mark.

Decked Vessels

$$F_{amber} \text{ (cm)} = 100 \times H_{s_{amber}} \times \left(\frac{B(\text{metres})}{LOA(\text{metres})} \right)$$

$$F_{red} \text{ (cm)} = \frac{(F_{amber})}{2}$$

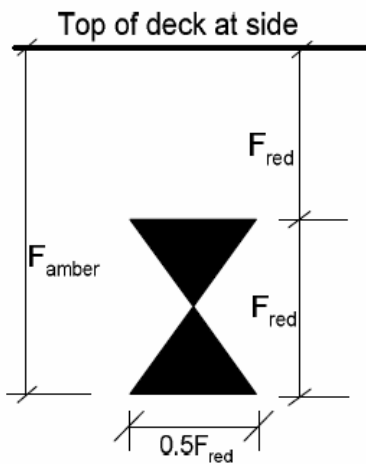

Undecked Vessels

$$F_{\text{red}} \text{ (cm)} = 2.6 \times B \times HS_{\text{red}} / LOA \times 100$$

$$\text{Height of the Mark (cm)} = 0.5 \times F_{\text{red}}$$

$$\text{Width of the Mark (cm)} = 0.25 \times F_{\text{red}}$$

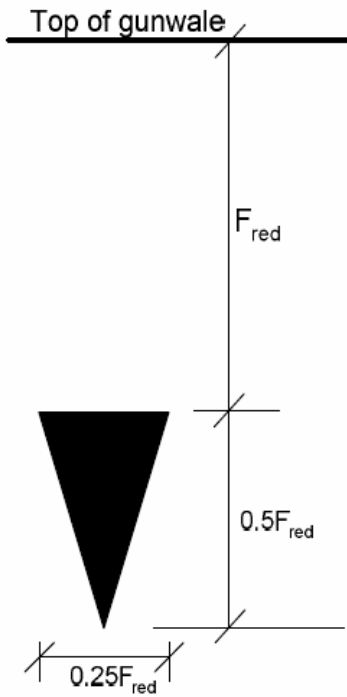

EXAMPLE STABILITY NOTICES

13.91m Decked Vessel

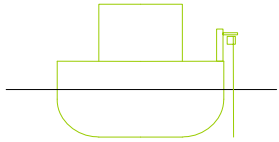
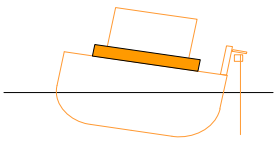
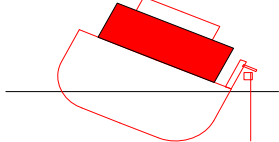
STABILITY NOTICE				
Name A Vessel No. 0 Owner Mr Smith Length 13.91 metres Beam 4.89 metres	Loading & Lifting Guidance	Safety Zone	Minimum Freeboard	Maximum Recommended Seastate
	Good margin of residual freeboard	Good margin of safety	At least 55 cm	
	Loading or lifting reduces minimum freeboard to less than 55 cm	Low level of safety	27 to 55 cm	1.6 metres
	Excessive loading or lifting reduces minimum freeboard to less than 27 cm	Danger of capsize	Less than 27 cm	0.8 metres

6.44m Open Vessel

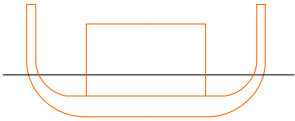
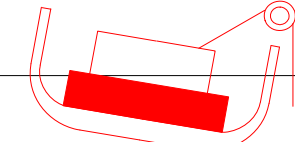
STABILITY NOTICE				
Name Noname No. 0 Owner Mrs Potter Length 6.44 metres Beam 2.66 metres	Loading & Lifting Guidance	Safety Zone	Minimum Freeboard	Maximum Recommended Seastate
	Even with a freeboard of at least 48 cm, swamping may be a hazard	Low level of safety	At least 48 cm	
	Excessive loading or lifting reduces minimum freeboard to less than 48 cm	Danger of capsize	Less than 48 cm	0.4 metres