



Rail Accident Investigation Branch

# Rail Accident Report



**Train overspeeding at Spital Junction,  
Peterborough  
17 April 2022**

Report 06/2023  
July 2023

This investigation was carried out in accordance with:

- the Railway Safety Directive 2004/49/EC
- the Railways and Transport Safety Act 2003
- the Railways (Accident Investigation and Reporting) Regulations 2005.

© Crown copyright 2023

You may reuse this document/publication (not including departmental or agency logos) free of charge in any format or medium. You must reuse it accurately and not in a misleading context. The material must be acknowledged as Crown copyright and you must give the title of the source publication. Where we have identified any third party copyright material you will need to obtain permission from the copyright holders concerned. This document/publication is also available at [www.gov.uk/raib](http://www.gov.uk/raib).

Any enquiries about this publication should be sent to:

RAIB	Email: <a href="mailto:enquiries@raib.gov.uk">enquiries@raib.gov.uk</a>
The Wharf	Telephone: 01332 253300
Stores Road	Website: <a href="http://www.raib.gov.uk">www.raib.gov.uk</a>
Derby UK	
DE21 4BA	

This report is published by the Rail Accident Investigation Branch, Department for Transport.

## Preface

The purpose of a Rail Accident Investigation Branch (RAIB) investigation is to improve railway safety by preventing future railway accidents or by mitigating their consequences. It is not the purpose of such an investigation to establish blame or liability. Accordingly, it is inappropriate that RAIB reports should be used to assign fault or blame, or determine liability, since neither the investigation nor the reporting process has been undertaken for that purpose.

RAIB's findings are based on its own evaluation of the evidence that was available at the time of the investigation and are intended to explain what happened, and why, in a fair and unbiased manner.

Where RAIB has described a factor as being linked to cause and the term is unqualified, this means that RAIB has satisfied itself that the evidence supports both the presence of the factor and its direct relevance to the causation of the accident or incident that is being investigated. However, where RAIB is less confident about the existence of a factor, or its role in the causation of the accident or incident, RAIB will qualify its findings by use of words such as 'probable' or 'possible', as appropriate. Where there is more than one potential explanation RAIB may describe one factor as being 'more' or 'less' likely than the other.

In some cases factors are described as 'underlying'. Such factors are also relevant to the causation of the accident or incident but are associated with the underlying management arrangements or organisational issues (such as working culture). Where necessary, words such as 'probable' or 'possible' can also be used to qualify 'underlying factor'.

Use of the word 'probable' means that, although it is considered highly likely that the factor applied, some small element of uncertainty remains. Use of the word 'possible' means that, although there is some evidence that supports this factor, there remains a more significant degree of uncertainty.

An 'observation' is a safety issue discovered as part of the investigation that is not considered to be causal or underlying to the accident or incident being investigated, but does deserve scrutiny because of a perceived potential for safety learning.

The above terms are intended to assist readers' interpretation of the report, and to provide suitable explanations where uncertainty remains. The report should therefore be interpreted as the view of RAIB, expressed with the sole purpose of improving railway safety.

Any information about casualties is based on figures provided to RAIB from various sources. Considerations of personal privacy may mean that not all of the actual effects of the event are recorded in the report. RAIB recognises that sudden unexpected events can have both short- and long-term consequences for the physical and/or mental health of people who were involved, both directly and indirectly, in what happened.

RAIB's investigation (including its scope, methods, conclusions and recommendations) is independent of any inquest or fatal accident inquiry, and all other investigations, including those carried out by the safety authority, police or railway industry.

This page is intentionally left blank

# Train overspeeding at Spital Junction, Peterborough, 17 April 2022

## Contents

<b>Preface</b>	3
<b>Summary</b>	7
<b>Introduction</b>	8
Definitions	8
Acknowledgements	8
<b>The incident</b>	9
Summary of the incident	9
Context	10
<b>Background information</b>	15
<b>The sequence of events</b>	25
Events preceding the incident	25
Events during the incident	25
Events following the incident	31
<b>Analysis</b>	33
Identification of the immediate cause	33
Identification of causal factors	33
Identification of underlying factors	44
Factors affecting the severity of consequences	49
Factors associated with the post-incident response	51
Occurrences of a similar character	52
<b>Summary of conclusions</b>	55
Immediate cause	55
Causal factors	55
Underlying factors	55
Factors affecting the severity of consequences	55
Factors associated with the post-incident response	55
<b>Actions reported as already taken or in progress relevant to this report</b>	56
<b>Background to RAIB's recommendations</b>	57

<b>Recommendations and learning points</b>	58
Recommendations	58
Learning points	60
<b>Appendices</b>	61
Appendix A - Glossary of abbreviations and acronyms	61
Appendix B - Investigation details	62
Appendix C - RAIB urgent safety advice	63
Appendix D - Network Rail incident notice	65

## Summary

At around 10:20 hrs on 17 April 2022, the 08:20 hrs Lumo service from Newcastle to London King's Cross, passed over three sets of points at Spital Junction at the northern approach to Peterborough station at excessive speed. The maximum permitted speed over the junction is initially 30 mph (48 km/h) reducing to 25 mph (40 km/h). The data recorder from the train indicated that the points had been traversed at a speed of 76 mph (122 km/h).

The speed of the train over the junction resulted in sudden sideways movements of the vehicles. This led to some passengers being thrown from their seats and luggage falling from the overhead storage, with some passengers receiving minor injuries. Although the train did not derail, and no damage was caused, post-incident analysis has indicated that the train was close to a speed that would have led to it overturning, and it was likely that some of the wheels of the vehicles lifted off the rails.

RAIB's investigation found that the overspeeding was caused by the driver of train 1Y80 not reacting appropriately to the signal indication they had received on approach to the junction. This signal indication was a warning that the train was to take a diverging route ahead which had a lower speed limit than the straight-ahead route which they were expecting to take. The driver's awareness of the signal conditions that could be presented on approach to this junction and their training were not sufficient to overcome this expectation.

RAIB found that Lumo had not assessed and controlled the risk associated with trains being unexpectedly routed on a slower, diverging route at this location and that it had not adequately trained the driver to prepare for this eventuality. Network Rail had also neither assessed nor effectively controlled the risk of overspeeding at locations where there is a long distance between the protecting signal and the junction itself. The investigation also found that half of the passenger injuries were as a result of falling luggage that had been stowed in the overhead luggage racks.

RAIB has made four recommendations. The first recommendation is for Lumo to review its processes to ensure that it effectively controls the risk of overspeeding at diverging junctions. The second recommendation asks Network Rail to identify junctions where there is a greater potential for overspeeding to occur and to work with operators to share information on the associated risks. The third recommendation asks Network Rail and train operators to consider and implement risk control measures at those junctions identified in the second recommendation. The fourth recommendation is intended to ensure that Lumo minimises the risks from falling luggage on its services.

RAIB has also identified two learning points. These relate to the need for drivers to maintain alertness when approaching junction signals and that train operator emergency plans should specifically include processes to deal with the aftermath of overspeeding incidents.

### [May 2023 overspeeding incident](#)

At around 13:00 hrs on 4 May 2023, another overspeeding incident occurred at the same location involving a Grand Central service. As a result, RAIB issued urgent safety advice to the industry and announced its intention to investigate this second incident. Further details can be found at paragraph 195 of this report.

## Introduction

### Definitions

- 1 Metric units are used in this report, except when it is normal railway practice to give speeds and locations in imperial units. Where appropriate the equivalent metric value is also given.
- 2 The report contains abbreviations. These are explained in appendix A. Sources of evidence used in the investigation are listed in appendix B.

### Acknowledgements

- 3 RAIB is grateful to the Railway Performance Society (<https://www.railperf.org.uk/>) for its assistance in providing train performance data to support this investigation.



## The incident

### Summary of the incident

- 4 At around 10:20 hrs on 17 April 2022, train reporting number 1Y80, which was the 08:20 hrs Lumo service from Newcastle to London King's Cross, passed over three sets of points at Spital Junction at the northern approach to Peterborough station at excessive speed. The maximum permitted speed over the junction is initially 30 mph (48 km/h) reducing to 25 mph (40 km/h). The data recorder from the train indicated that the points had been traversed at a speed of 76 mph (122 km/h). Following the driver's application of the emergency brake, the train came to a stand at the south end of platform 1.
- 5 The train was not due to call at Peterborough. It was travelling on the Up Fast line before reaching P468 signal on the approach to Spital Junction. P468 signal was indicating that the route ahead was set for a diverging route directing the train to the Up Slow line via platform 1.

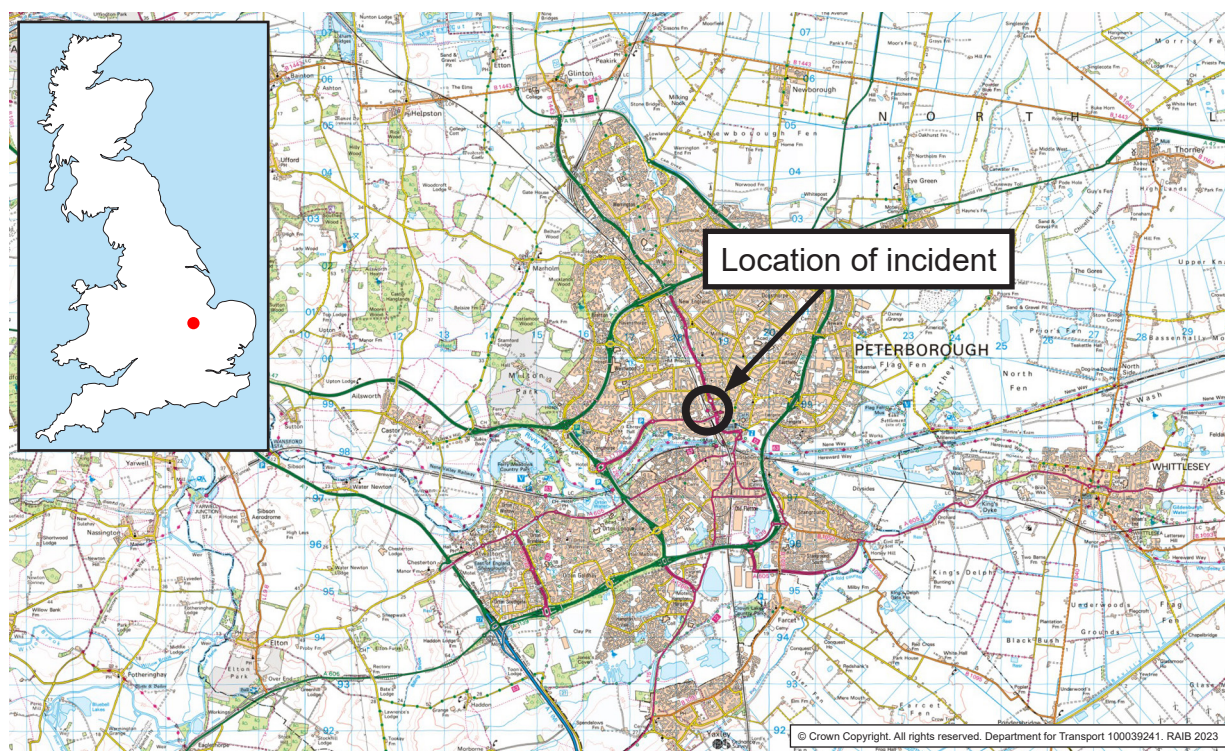

Figure 1: Extract from Ordnance Survey map showing location of the incident at Peterborough station.

- 6 The excessive speed of the train over the junction resulted in sudden sideways movements of the vehicles. This led to some passengers being thrown from their seats and luggage falling from the overhead storage racks causing minor injuries to some passengers.
- 7 Although the train did not derail during the incident, post-incident simulation and analysis indicated that the train was close to a speed that would have led to it overturning and it was likely some of the train wheels lifted off the rails.

## Context

### Location

- 8 Spital Junction is located to the north of Peterborough station on the East Coast Main Line. The Up Fast line leads to the junction and then continues through the station alongside platform 3. The maximum allowable line speed on the Up Fast line is 125 mph (201 km/h), reducing to 105 mph (169 km/h) shortly after the junction and through platform 3. The diverging junction over which the train passed has a maximum allowable speed of 30 mph (48 km/h) and directs trains to the Up Slow lines via platforms 1 and 2 (figure 2).

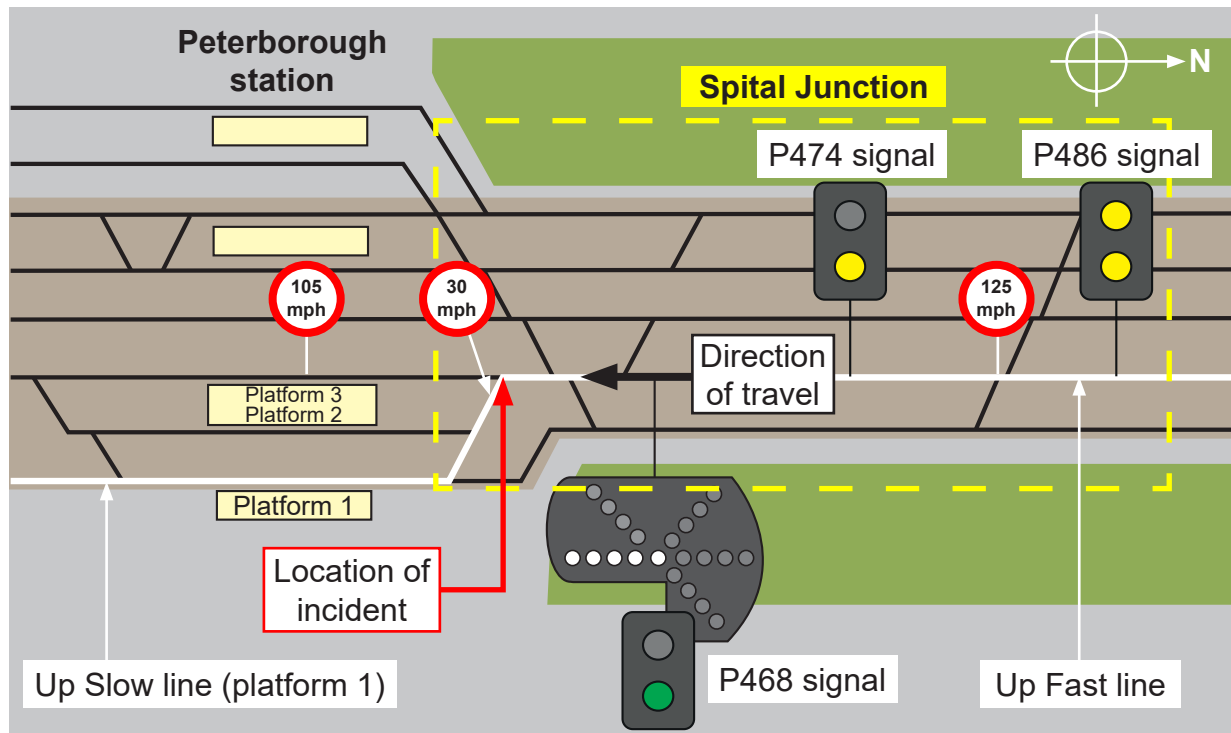

Figure 2: Location of the incident and a schematic diagram of the main features on the north approach to Peterborough station.

### Organisations involved

- 9 Lumo, the trading name of East Coast Trains Limited, is an open-access operator<sup>1</sup> owned by FirstGroup plc. Lumo was the operator of the train and is the employer of the driver and train crew. Lumo started its passenger operations on 25 October 2021.
- 10 Network Rail is the owner and maintainer of the infrastructure on which the incident took place. It is the employer of the signalling staff on duty at Peterborough signal box on the day of the incident.
- 11 Lumo and Network Rail freely co-operated with the investigation.

### The train involved

- 12 Train 1Y80 was formed of a five-car class 803 Hitachi AT300 electric multiple unit (figure 3).

<sup>1</sup> Open-access operators run trains on the rail infrastructure, having commercial agreements to buy train paths, rather than operating via a franchise agreement or contracts with the government.



- 13 A review of the internal saloon closed-circuit television (CCTV) which was made available to RAIB indicates that there were around 260 passengers on board during the incident.



Figure 3: Lumo class 803 Hitachi AT300 electric multiple unit.

### The junction involved

- 14 The diverging route at the junction, over which the train passed, comprises three turnouts<sup>2</sup> (figure 4). The first turnout reached, which includes 1243 points, has a maximum permitted speed of 30 mph (48 km/h). The remaining two turnouts have maximum permitted speeds of 25 mph (40 km/h). When viewed in the direction of the train's travel, the first and second sets of points are facing points while the third are trailing points. The maximum line speed on the Up Slow line through platform 1 is 50 mph (80 km/h).
- 15 Trains approaching on the Up Fast line are signalled from P468 signal across the junction. The signal is located around 700 metres on the approach to the point of divergence towards the Up Slow No 1 and Up Slow No 2 lines which lead to platforms 1 and 2 respectively. P468 signal is a four-aspect colour light signal with a junction indicator (JI), sometimes known as a position light junction indicator (figure 5). P468 signal can display red, yellow and green aspects in the lower aperture and an additional yellow in the top aperture when required to display double yellow aspects.

<sup>2</sup> A turnout consists of a set of switches and a crossing.

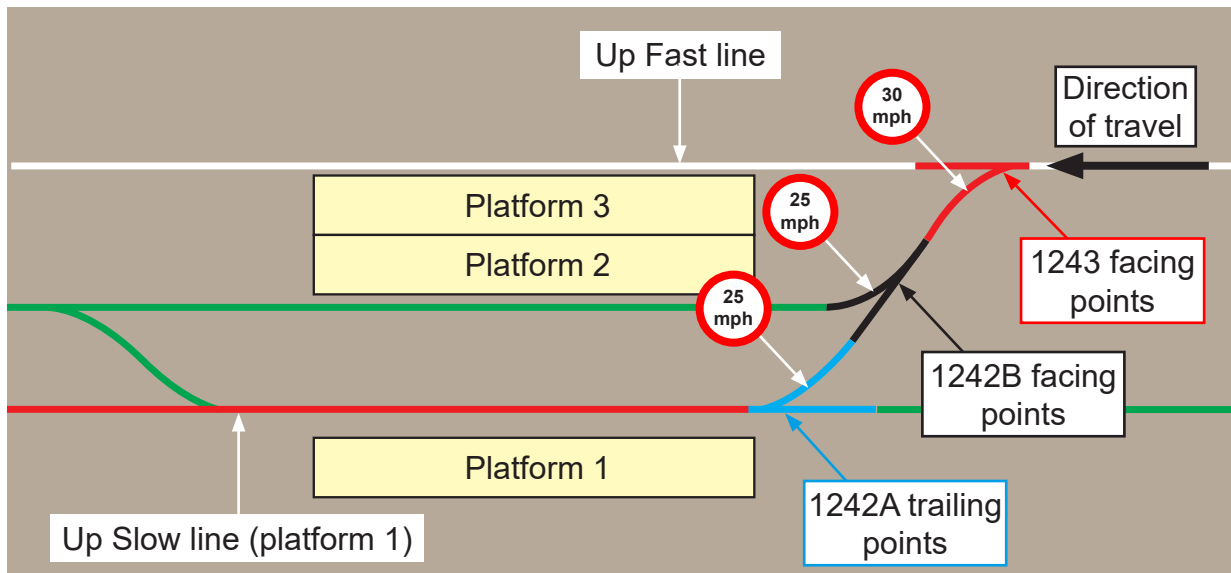

Figure 4: Details of the track layout at the diverging junction to the Up Slow lines.

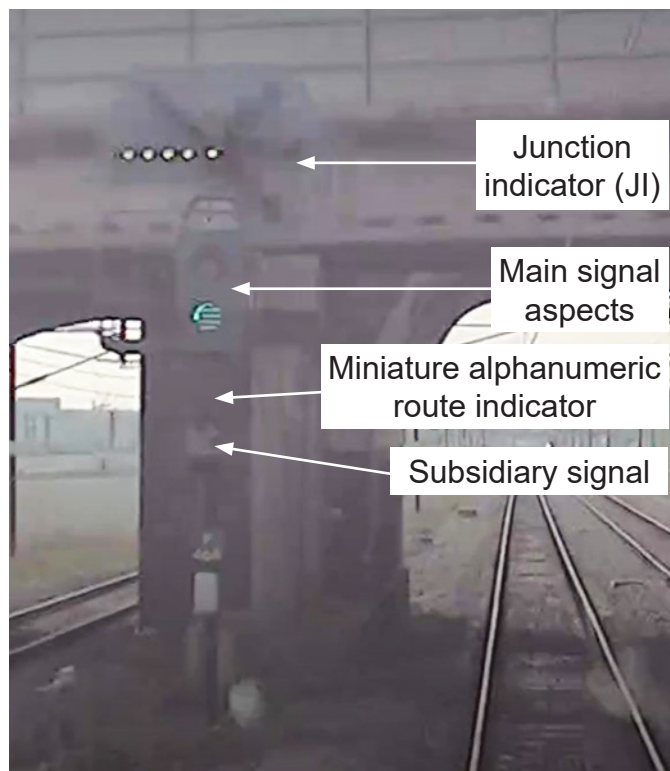

Figure 5: Annotated image of P468 signal.

- 16 The JI on P468 signal can show five different indications, meaning a train can be signalled to go in one of six different ways beyond the signal (the JI is not illuminated for trains going straight ahead on the Up Fast line). Figure 6 shows where a train can go to from this signal and what the associated JI indication will be for that route. The signal is also fitted with a subsidiary signal and a miniature alphanumeric route indicator. These are for occasions when a train is signalled into a platform at Peterborough station that is already occupied by another train and are not relevant to this incident.

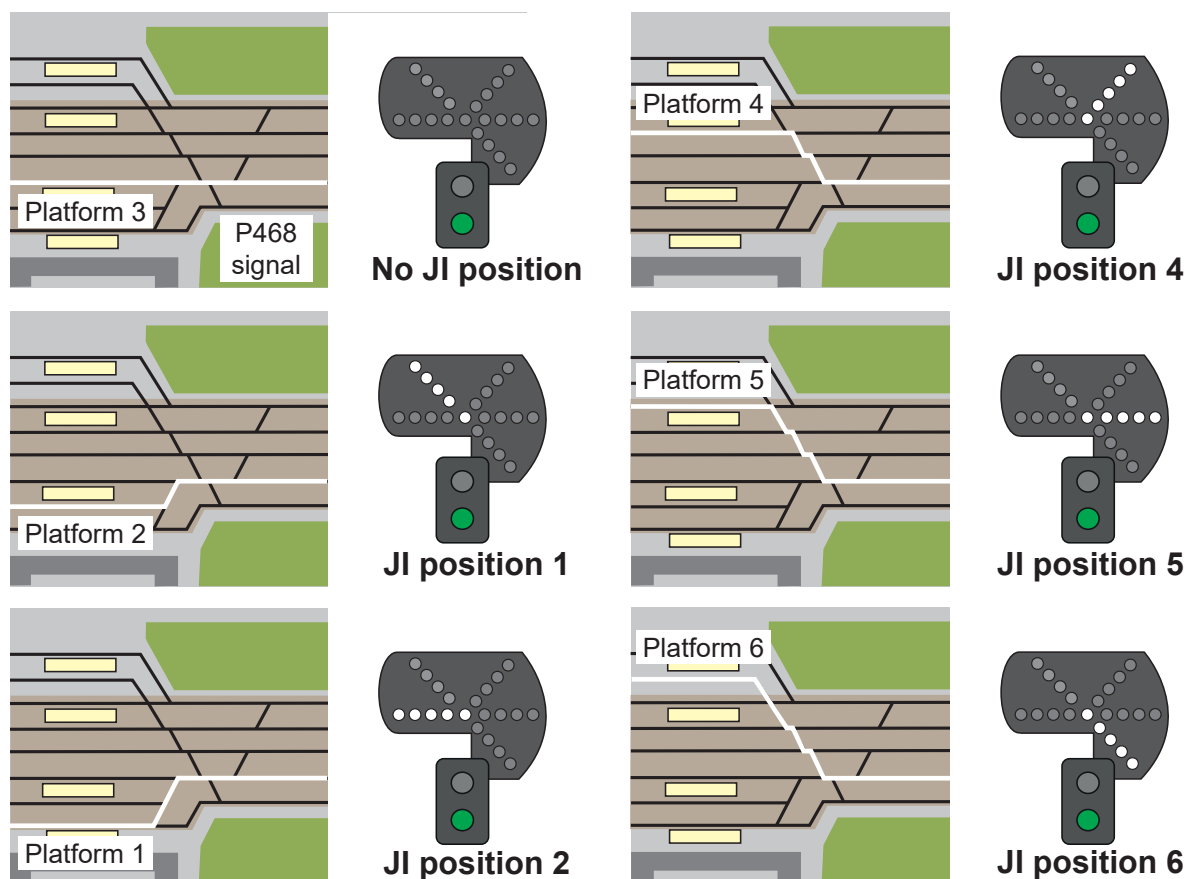

Figure 6: Routes from P468 signal and the associated JI indication.

- 17 P468 signal protects a complex junction and so has controls applied to the signal aspects it displays. A junction signal protecting a diverging route with a slower permissible speed can be held at red, or sometimes yellow, until the train reaches a predetermined point where the driver has an unrestricted view of the signal to read what it is displaying. This predetermined point is normally defined by the train occupying a particular track section. If needed, the predetermined point can be adjusted by using a timer to require the track section to be occupied for a specified period, although this does introduce some variance as the predetermined point is then dependent upon the train's speed.
- 18 A driver responding to the preceding cautionary signals will slow the speed of their train as they would do approaching a stop signal. When the train reaches the predetermined point, the aspect on the junction signal is allowed to step up to a less restrictive aspect. This form of control is known as approach release and does not give a driver any indication of the divergence until reaching close to the junction signal.
- 19 P468 signal can also be part of a sequence of signals which uses flashing yellow aspects to advise drivers that they will be taking a slower speed divergence at an upcoming junction. This sequence is used for routes with smaller reductions in speed at the diverging junction compared to the straight on route. It provides an advanced warning of the slower speed divergence by flashing the preceding caution signals and by holding the junction signal at yellow. Drivers should respond to this advance warning by reducing the speed of their trains to the speed of the diverging route before being able to see the junction signal step up from yellow and read the associated route indication.

### Staff involved

- 20 The driver of train 1Y80 joined Lumo as a trainee (apprentice) driver in September 2020. They were passed out as competent on 3 February 2022, having completed Lumo's driver training programme and having signed for the route. The incident journey was the 24th occasion the driver had driven a train unaccompanied from Newcastle towards Peterborough since qualifying. During their training, the driver had also driven this journey 77 times when accompanied either by a driving mentor or a driving assessor.
- 21 There were also two Lumo customer ambassadors on board the train providing customer service.
- 22 One of the passengers on board was an off-duty Lumo driver. Following the incident, they drove the train onwards to London King's Cross station.
- 23 The signaller involved was based in Peterborough signal box and had worked there since mid-2021.

### External circumstances

- 24 The weather was dry, clear and sunny. It is possible that the sunny weather played a part in this incident (see paragraph 62).



## Background information

### The signalling system

- 25 The signalling system at Spital Junction is operated by a signaller in Peterborough signal box. The junction is signalled using the track circuit block system, with signals placed at specified distances along the railway. The spacing of the signals must be sufficient to allow a train, travelling at the maximum permissible speed for the line at the first signal displaying a cautionary aspect, to stop in the distance between the first signal showing a cautionary aspect and the (red) signal at which the train must stop. The locations of signals, and the distance between them, is affected by many factors, including the permissible speed on approach, gradient, and the visibility on approach.
- 26 The path from one signal to the next signal is called a route. In track circuit block signalling, the routes between the signals are divided into one or more track sections. The signalling system uses equipment, usually track circuits or axle counters, to determine if each track section is clear (meaning trains are detected as being absent from the track section) or occupied (meaning a train is detected or a fault exists in the track section).
- 27 Track circuit block signalling allows a signal to show a proceed (anything other than red) aspect when all the track sections beyond that signal, up to and including the overlap<sup>3</sup> of the next signal on the intended route, are clear. Where points are included within a route between signals, these must also be locked and detected in the correct position for a train to pass safely. These requirements are proved in the interlocking,<sup>4</sup> which determines when a signal can be allowed to show a proceed aspect. As well as controlling the operation of signals, the interlocking controls points and other signalling apparatus to prevent an unsafe condition of the signalling system arising during the passage of trains.
- 28 Signallers in Peterborough signal box use an electro-mechanical human-machine interface known as an entrance-exit (NX) panel to operate the signalling system that controls Spital Junction (figure 7). The panel shows the layout of the railway being controlled, along with indications which show the status of signals, the position of points and track section occupancy. The signaller requests a route by pressing a button for the signal at the start of the route (the entrance) and then pressing the appropriate button for the signal at the end of the route (the exit). The interlocking checks for conflicting train movements and, if the requested route is available, commands and locks any points to the required position to 'set' the route. When a route has been set, the signal will change to a proceed aspect when the track sections ahead are clear.
- 29 Signalling interlockings are split geographically and P468 signal falls within the control of Peterborough Central interlocking. To determine if a route can be set and what aspect P468 signal can display, information is taken from the adjacent Peterborough North and Peterborough South interlockings.

<sup>3</sup> The overlap is the distance beyond a signal which must be proved to be clear and in a safe condition before a train is permitted to approach the signal. It is usually 200 yards (183 metres).

<sup>4</sup> A general term applied to equipment that controls the setting and releasing of routes, signals, points and other apparatus to prevent an unsafe condition of the signalling system arising during the passage of trains.

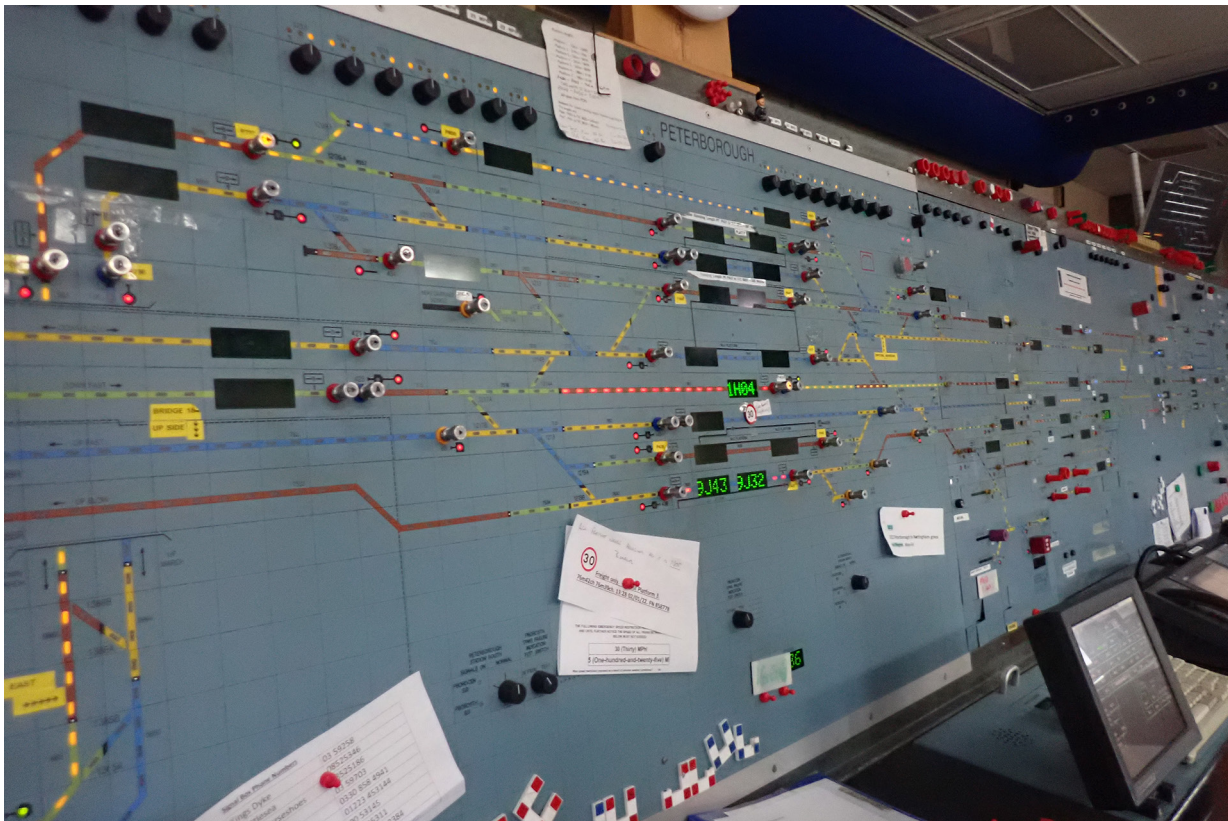

Figure 7: Peterborough NX panel.

30 Details of the six routes from P468 signal a signaller can set (paragraph 16) and the associated approach release conditions (paragraph 17) are shown in table 1. Note that signals referenced in column 2 below are located near the south end of their respective platforms.

To location	To signal	PLJI position	Route number	Condition(s) within the interlocking
Platform 1	P436	2	5(M)	Approach release from yellow (with flashing yellow aspect sequence) or approach release from red
Platform 2	P438	1	4(M)	Approach release from yellow (with flashing yellow aspect sequence) or approach release from red
Platform 3	P440	None	3(M)	None
Platform 4	P442	4	2(M)	Approach release from red
Platform 5	P444	5	1(M)	Approach release from red
Platform 6	P446	6	8(M)	Approach release from red

Table 1: The routes from P468 signal.

31 When the signaller sets a route towards platform 4, 5 or 6 for a train approaching on the Up Fast line, the interlocking applies 'approach release from red' control to P468 signal. This prompts the driver of the approaching train to slow down as the signal continues to display a red aspect on the junction signal until the train reaches a predetermined point (paragraph 17).



- 32 In this case, 'approach release from red' control is applied to P468 signal because trains can approach Peterborough on the Up Fast line at 125 mph (210 km/h), and if routed from this signal towards platform 4, 5 or 6, they will pass over sets of points which have permissible speeds of 15 mph (24 km/h). Approaching P468 signal displaying a red aspect should prompt the driver to slow down. When the train reaches the predetermined point, and the junction signal changes to show a proceed aspect, along with the required JI indication, the driver can then drive accordingly for the route which the train is signalled to take.

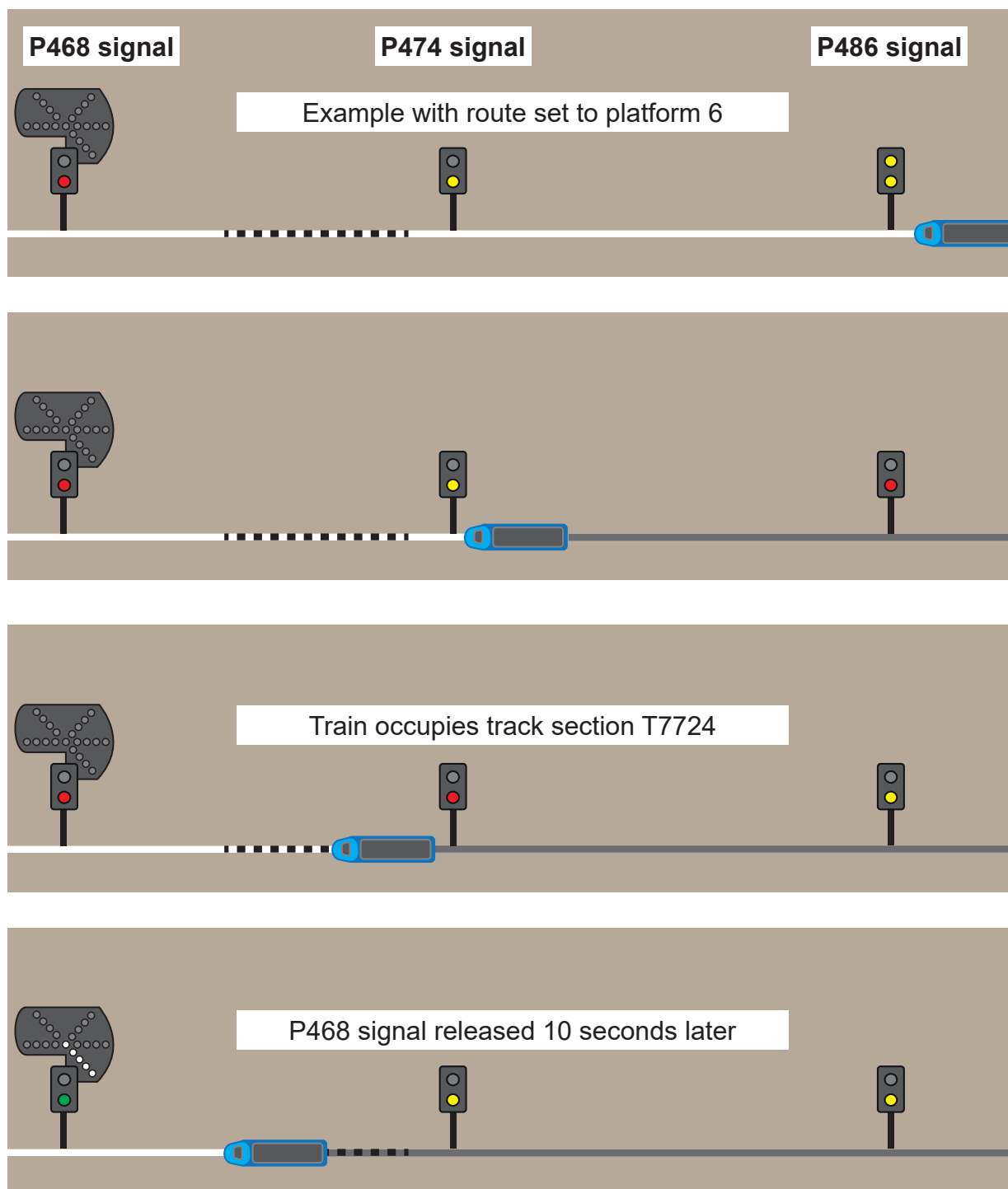

Figure 8: The aspect sequence for P468 signal when a route with approach release from red control is set.

- 33 Figure 8 shows that the sequence of aspects for P468 signal when a route towards platform 6 with approach release from red control is set (in this example P468 signal is shown displaying a green aspect when released, as a route is already set beyond the next signal at the end of platform 6). As the train travels towards P468 signal at red, it will occupy track section T7724, (indicated on figure 8 by a black dashed line) and start a timer. When the timer reaches 10 seconds, the interlocking will release the aspect control on P468 signal and allow it to display a proceed aspect and JI indication.
- 34 For the routes to platforms 1 and 2, there is less of a difference between the permissible speed approaching the junction and the permissible speed at the point of divergence. For these routes, approach release from yellow, with a flashing yellow aspect sequence on preceding signals, is used instead. This sequence still prompts the driver to slow the train down through the cautionary aspects displayed to the driver, but it is less restrictive than approach release from red, and hence provides some performance (time) benefits. It also has the advantage of providing the driver with information at the preceding signals that the train is signalled to take a diverging route at the junction signal.
- 35 When this control was implemented within the signalling system at Peterborough, the criteria for when the flashing yellow aspect sequence control could be used was defined in issue three of Railway Group standard GKRT0045 'Lineside Signals, Indicators and Layout of Signals' shown in table 2.

Permissible speed approaching the diverging junction	Permissible speed at the point of divergence
80 mph (129 km/h) to 125 mph (201 km/h)	40 mph (64 km/h) or greater
40 mph (64 km/h) to 75 mph (121 km/h)	25 mph (40 km/h) to 40 mph (64 km/h)

Table 2: Speed ranges for using the flashing yellow aspect sequence control.

- 36 For the routes from P468 signal to platforms 1 and 2, the permissible speed at the point of divergence is 30 mph (48 km/h). As the permissible speed on the approach is 125 mph (201 km/h), which falls outside of the criteria defined in table 2, a deviation to allow this was granted in 2014 (see paragraphs 46 to 49).
- 37 In its simplest form, when a route is set from P468 signal to either platform 1 or 2, and the required conditions in the interlocking are met, P468 signal will change to display a single yellow aspect and the relevant JI indication for the route to the chosen platform. In addition, the driver of an approaching train will see flashing yellow caution aspects on P486 and P474 signals in the sequence shown in figure 9. These cautionary flashing yellow aspects indicate that the route is clear up to the next signal beyond the junction, and that the train is to take a slower speed divergence at P468 signal towards either platform 1 or 2. In this situation the driver should be prepared to react to the aspect being displayed on P468 signal which provides information about the aspect of the first signal beyond the junction.

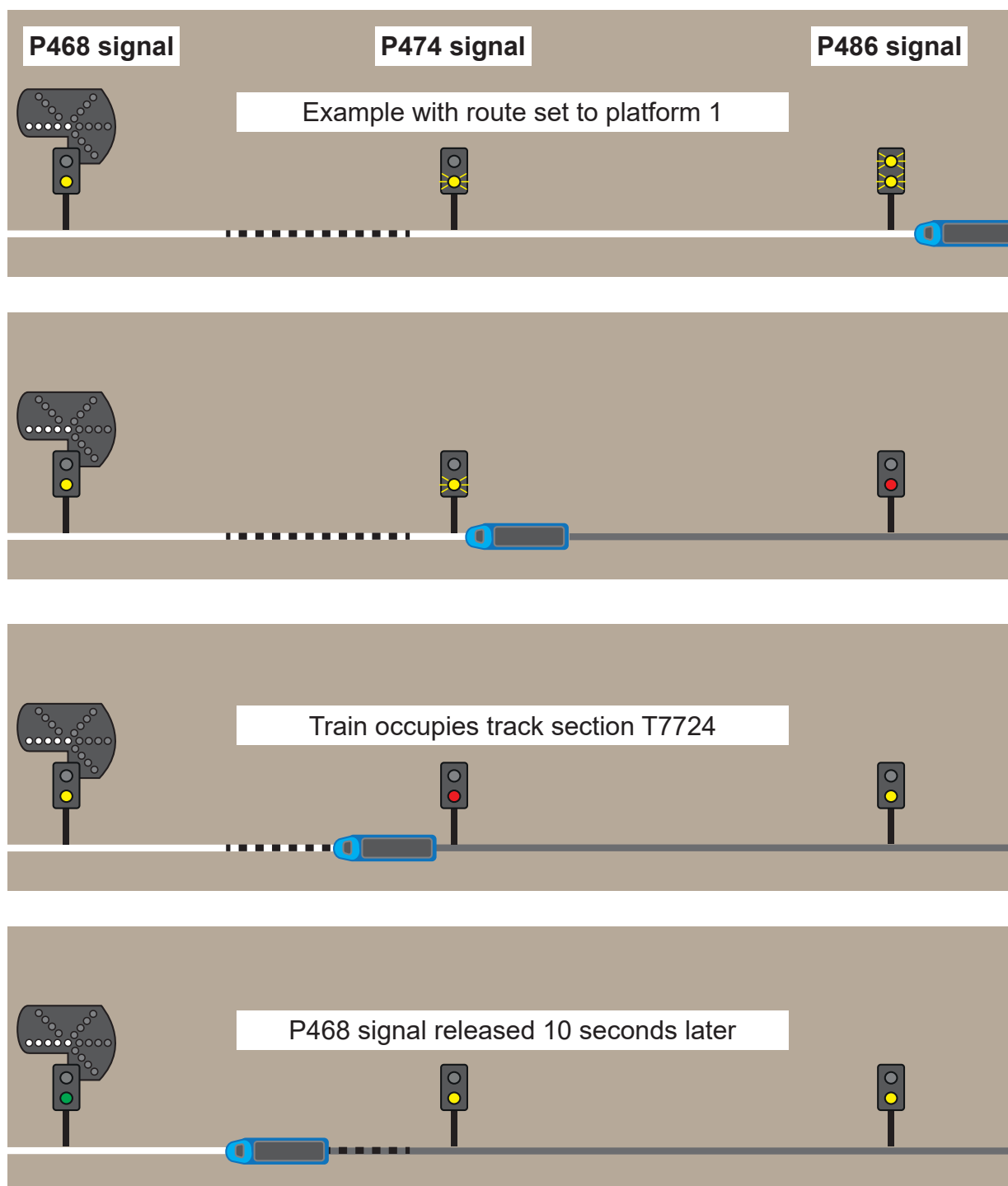

Figure 9: The aspect sequence for P468 signal when a route with flashing yellow aspect sequence control is set to platform 1.

- 38 Figure 9 shows that an approaching train will pass P486 signal displaying a flashing double yellow aspect and P474 signal displaying a flashing single yellow aspect. After passing P474 signal, the train will occupy track section T7724 as it continues towards P468 signal. As it was for the approach release from red control (paragraph 33), when this track section is occupied for 10 seconds, the interlocking will release the restriction on P468 signal and allow it to display a less restrictive proceed aspect as permitted by the aspect of the signal ahead.

- 39 If a train approaches on the Up Fast line when no route is set beyond P468 signal, P486 signal will display a double yellow aspect, P474 signal will display a single yellow aspect and P468 signal will display a red aspect. If the signaller then requests a route from P468 signal into platform 1 or 2 with a train approaching P474 signal, but not yet occupying track sections T7726 or T7725 (located between P486 and P474 signals), the interlocking will apply a flashing yellow sequence with a single flashing yellow aspect on P474 signal. At this distance from P474 signal, the driver has sufficient time to read the single flashing yellow aspect, and apply their route knowledge to understand that they are being routed at the junction signal towards either platform 1 or 2.
- 40 If, however, a train has already occupied either track section T7726 or T7725 when a route is subsequently set from P468 signal towards platform 1 or 2, the interlocking will not allow the flashing yellow aspect sequence control to be used. This is because the location of the train at this point means the driver will not have adequate time to read the flashing yellow aspect on P474 signal and take the appropriate action in response to it. In these circumstances, the interlocking applies the approach release from red control to P468 signal in the same way as when a route is set to platform 4, 5 or 6 (paragraph 31).
- 41 Train drivers on Network Rail infrastructure are provided with lineside signs to provide a point of reference where a permissible speed changes. Drivers are warned of a large speed reduction by a permissible speed warning indicator (PSWI). Trains approaching Spital Junction on the Up Fast line pass a PSWI which warns drivers about the reduction in speed for the 30 mph (48 km/h) divergence for the routes towards platforms 1 and 2. Figure 10 shows the PSWI and its location in relation to the other signalling equipment. The sign shows the 30 mph (48 km/h) permissible speed for the divergence and a directional arrow to indicate that it applies to the tracks to the left of the Up Fast line, that is, to the lines which lead to platforms 1 and 2.

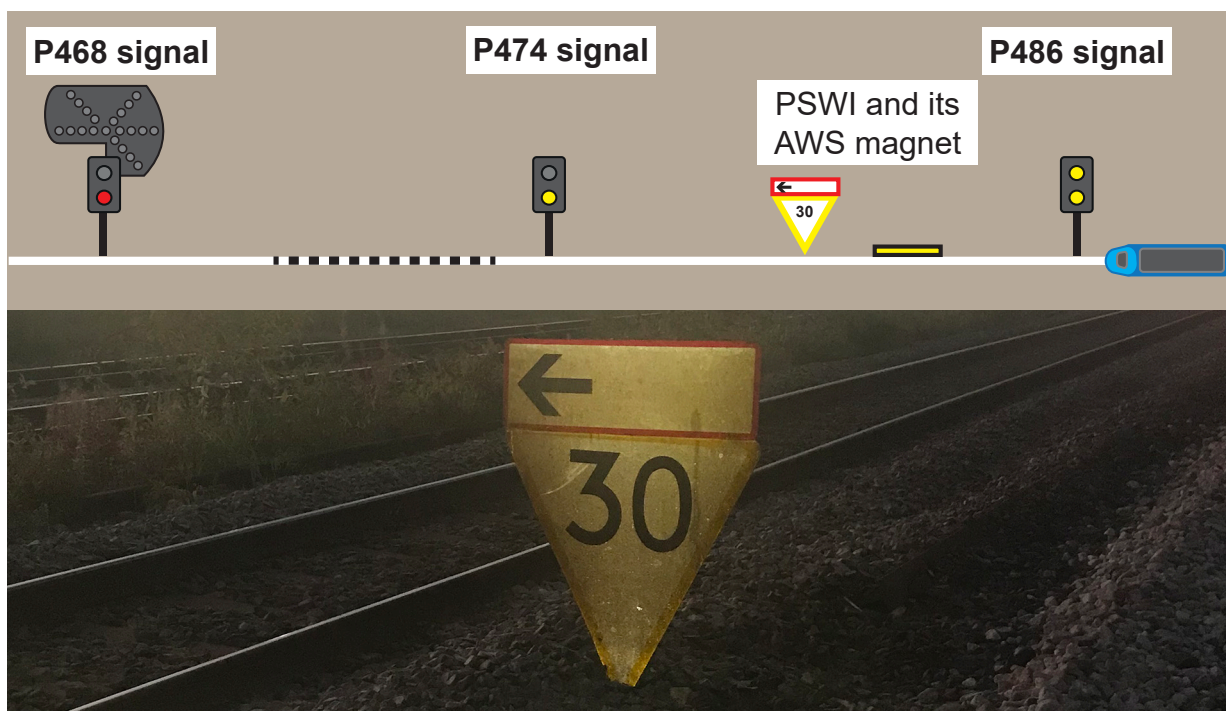

Figure 10: The location of the PSWI in relation to the other signalling equipment and an image of it (courtesy of Network Rail).

- 42 The PSWI is placed at the required deceleration distance of 2058 metres from the point of divergence, which is the distance needed for a train travelling at the permissible speed of 125 mph (201 km/h) to slow to 30 mph (48 km/h) for the divergence. This distance placed the PSWI between P486 and P474 signals. This PSWI, which is located between signals, is provided with its own automatic warning system (AWS) magnet situated about 180 metres on the approach to the PSWI sign. When a train passes over the magnet, it causes an audible warning in the cab which the driver must acknowledge within a specified time, or an emergency brake application will occur. The aim of this AWS warning is to alert the driver to the PSWI, which in turn aims to remind the driver about the slower speed divergence that is ahead.
- 43 At the time the signalling was commissioned, issue two of Railway Group standard GKRT0075 'Lineside Signal Spacing and Speed Signage' was in force. This standard required the AWS magnet to be suppressed when the junction signal, and any intervening signals between the PSWI and the junction signal, had been cleared for a route for which the PSWI does not apply. This was so that drivers of trains signalled towards these other routes did not receive an AWS warning for the PSWI when these routes were set and the signals had cleared. A similar requirement is made by the currently applicable standard, issue two of Rail Industry standard RIS-0734-CCS 'Signing of permissible speeds'. This states that the AWS magnet provided for the PSWI should be suppressed when the route is set for a train to proceed on a line to which the PSWI does not apply. However, the current standard does not require the junction signal and any intervening signals to have cleared as well.
- 44 The interlocking for the signalling at Spital Junction only suppresses this AWS magnet when the straight-ahead route from P468 signal towards platform 3 is set, as for this route, the junction signal can show a proceed aspect before the train passes the PSWI. This configuration met the requirements of issue two of GKRT0075. For all the other routes which can be set from P468 signal, including those for trains going to platforms 4, 5 or 6 where the PSWI does not apply, the AWS magnet is not suppressed, as the junction signal cannot show a proceed aspect at the time the train is passing the AWS magnet (paragraph 17). This means that unless the route straight ahead to platform 3 has been set, a driver will receive an AWS warning at the PSWI. If no route has been set from P468 signal at the time a train passes the PSWI, a driver will get an AWS warning, even if the train is subsequently routed straight on the Up Fast line through platform 3.

#### The history of P468 signal

- 45 The last time the signalling system at Spital Junction was changed was in 2013 and 2014 when the station infrastructure at Peterborough was remodelled. This work included the removal of a bay platform that had previously been platform 1, the previous platforms 2 and 3 being lengthened and renumbered to platforms 1 and 2 respectively, and the construction of three new platforms. This included a new platform 3 for trains on the Up Fast line. The work was completed in March 2014.



- 46 A process exists for engineering projects to implement work outside of the requirements of railway engineering standards. When this work took place, the project implementing the changes to the signalling system sought a deviation against clause 5.2.3.1 in GKRT0045 (paragraph 35) from the control command and signalling committee at Rail Safety and Standards Board<sup>5</sup> (RSSB). Contrary to the requirements of this clause, the project wished to provide flashing yellow aspect sequence controls for the routes from P468 signal to platforms 1 and 2. This was in addition to the existing approach release from red controls required for platforms 4, 5 and 6. This deviation was needed because the permissible speed at the divergence for these routes was 30 mph (48 km/h), whereas the clause required the permissible speed to be a minimum of 40 mph (64 km/h) as shown in table 2 (paragraph 36).
- 47 In its submission for the deviation, the project argued that approach release from red controls carry with them a risk of drivers wrongly anticipating a signal clearing to a proceed aspect when it remains at red, leading to the signal being passed at danger. In addition, this form of control required trains to accelerate towards the junction to the Up Slow lines after the signal had cleared, due to the point of divergence being 700 metres from P468 signal. It also said that train operating companies had raised these issues from a journey performance and a safety perspective, so had requested that the controls for P468 signal were amended.
- 48 The project had considered alternative options. These included:
- Relaxing the existing approach release from red controls to allow the junction signal to show a proceed aspect when the JI indication was readable. The project stated that while this option would provide a reduction in anticipation and acceleration risk, this would not be as great as providing flashing yellow aspect sequence controls.
  - Imposing a permanent speed restriction of 75 mph (121 km/h) on the approach to the divergence, so that it met the requirements shown in table 2. The project explained that this would have a negative journey performance impact on all trains and was deemed to be unacceptable.
  - Renewing the turnouts to allow a divergent speed of at least 40 mph (64 km/h). The project stated that the cost of this option was deemed to significantly exceed any safety benefit. However, if the turnouts were to be renewed in the future which allowed the permissible speed over them to be raised to at least 40 mph (64 km/h), then minimal subsequent signalling alterations would be required.
- 49 The project submitted its application for a deviation in December 2013. It was agreed by the control command and signalling committee at RSSB in February 2014 which allowed the current signalling arrangement to be commissioned.

---

<sup>5</sup> A not-for-profit body whose members are the companies making up the railway industry.

### Visibility and conspicuity of P468 signal

- 50 Guidance relevant to the readability of the main aspects of signals and their associated JI is contained, for a signal such as P468 signal, in Rail Industry Guidance Note GKGN0657 'Guidance on lineside signal and indicator product design and assessment requirements'. Appendix E of GKGN0657 refers to five categories of readability performance for signals. Readability is defined by the standard as 'the ease and reliability with which signal aspects and indications can be read... throughout the range of operational and ambient conditions applicable to that hardware, within the operational context and while performing typical required duties'.
- 51 Long-range colour light signals and JIs fall within category 1 of appendix E. This category of equipment is required to have a readable distance performance of 800 metres at a maximum permissible speed of 125 mph (201 km/h). When P468 signal was commissioned, it was subject to a signal sighting assessment by Network Rail to confirm its readability at this location. Signal sighting checks conducted by Network Rail following this incident confirm that the signal, and its alignment, still conforms to the required level of readability.
- 52 The Railway Group and Rail Industry standards which cover the operational requirements for the positioning of colour light signals and JIs consider many factors that affect a signal's visibility, and hence also its readability, when deciding where to place that signal. The requirements in the standards for signal positioning are determined by a number of factors that affect both readability and drivability (how easy it is for train drivers to take trains along a particular route safely and reliably). Network Rail will work collaboratively with the relevant train operating companies to determine where a signal should be placed.
- 53 An important factor is the amount of time that the signal is readable, that is to say the time it can be seen by the driver, when a train approaches it. Appendix E in GKGN0657 includes a table that sets out examples of the minimum reading times for a range of permissible speeds, from which a minimum readable distance can be calculated. As an example, the table shows that for an approach speed of 125 mph (201 km/h), to obtain a readable time of 12 seconds, which is likely to be the time needed for a junction signal with a JI, the minimum readable distance for a signal in that scenario needs to be 667 metres. This means that the signal needs to be placed so that a driver has an uninterrupted view of it, having been able to start reading it, from at least 667 metres away.
- 54 As the permissible speed on the Up Fast line on the approach to P468 signal is 125 mph (201 km/h), a train would only ever approach P468 signal at such a high speed if the straight-on route through platform 3 was set. If any other route was set from P468 signal, the driver would have seen cautionary aspects on the previous signals, P486 and P474. As a result, the train would be travelling at a much slower speed as it approached P468 signal. This means that the duration over which the signal is readable would be much greater.
- 55 The Railway Group and Rail Industry standards also explain that, if a signal is capable of presenting route information for the layout ahead, such as a JI, the driver must then be given more time to read the signal to interpret the information that is being presented.

- 56 When changes are made to a signal or a new signal is installed, a signal sighting assessment process (known as 'signal sighting') is used to confirm the compatibility of the lineside signalling system assets with train operations. Signal sighting should consider any factors that might affect the visibility and conspicuity of a signal before it can be commissioned into service. No issues were reported with P468 signal the last time it was subject to a signal sighting assessment during a cab ride in July 2021. It was noted during the consultation regarding the proposed change in operation of this signal (see paragraph 147), that the signal has a dark back board, and it is located next to a bridge over the railway which also provides a dark background to help the signal's conspicuity.
- 57 Rail Industry standard RIS-0737-CCS 'Signal sighting assessment requirements'<sup>6</sup> defines the requirements for positioning a JI in relation to the signal head containing the main aspects. These requirements state that the JI shall usually be positioned with the pivot light (this is the light at the centre of the JI which is shared by all JI indications) directly above the main signal aspects. This was the configuration used for P468 signal.
- 58 The signal sighting assessment process also considers the distance between the JI and the signal head. It explains that this distance should take account of misreading risks that could arise from either simultaneously illuminated displays overpowering each other or the associated displays being so far apart they are not correctly read together. Guidance for the signal sighting process in Rail Industry standard RIS-0737-CCS states that the distance between the upper main aspect and the JI pivot light should be a minimum of 550 mm. No maximum distance is given, but it does state they should not be so far apart that a driver might not associate the JI with the signal aspect. RAIB estimated from photographic evidence that for P468 signal the distance between the pivot light and main aspect was approximately 1140 mm. This distance is a legacy from when the previous filament lamp signal head was replaced and a light emitting diode signal head fitted into the existing frame. Because of the distance at which the signal was seen and reacted to by the driver in this incident (see paragraph 74), the difference in the height above the minimum specified is not significant.

### Positioning of P468 signal

- 59 Junction signals are placed as close as possible to the junction they protect and not more than 800 metres away from the point of divergence in accordance with GKRT0045. This reduces the risk of drivers mishandling their train as a consequence of forgetting the route they are to take or having to travel for long periods at a reduced speed to comply with the upcoming junction speed.
- 60 P468 signal is located about 700 metres from the point of divergence to platforms 1 and 2. Moving P468 signal closer to the point of divergence would be challenging because of the bridge where the signal is currently located, as well as another bridge over the railway about 600 metres beyond it affecting the signal sighting. Also, by changing the location of P468 signal, it could potentially have an impact on the placement of other signals over many miles further back along the Up Fast line to ensure that they are spaced to maintain the correct distances needed for train braking.

---

<sup>6</sup> RIS-0737-CCS, 'Signal sighting assessment requirements', issue 1, June 2016.



## The sequence of events

### Events preceding the incident

- 61 On the morning of Sunday 17 April 2022, the driver involved in the incident booked on for duty at 06:17 hrs. They then prepared the train at Heaton depot and drove, with a route conductor,<sup>7</sup> for the part of the journey to Newcastle Central station. The service left Newcastle on time at 08:20 hrs as train reporting number 1Y80. It was scheduled to only stop at Stevenage before terminating on arrival at London King's Cross station.
- 62 The journey north of Peterborough was reported to be uneventful and nothing of relevance occurred other than the driver partially lowering the sun blind when the train was around Durham, to minimise sun glare (this is considered further at paragraph 91).
- 63 Signalling data records show that at 09:57 hrs, train 1Y80 passed Grantham, 28 miles (45 km) north of Peterborough and was 3 minutes early. It then started to encounter a series of signals at caution, first double yellow then single yellow aspects, indicating to the driver that the train was catching up with a slower train ahead. The driver regulated the speed of the train to approximately 95 mph (150 km/h) so that the signals ahead were changing to green aspects as the train approached them.
- 64 Ahead of train 1Y80 was train 1L06, the 09:20 hrs East Midlands Railway (EMR) service from Nottingham to Norwich. This was running to time and was scheduled to stop at Peterborough platform 6 via its normal routed path on the Up Fast line.
- 65 Behind train 1Y80 was train 1Y16. This was the late running 07:54 hrs London North Eastern Railway (LNER) service from Newcastle to London King's Cross. This train was scheduled to stop at platform 3 at Peterborough station on its normal path on the Up Fast line. By the timetable, train 1Y16 should have been ahead of train 1Y80, but the latter had earlier overtaken the late running train 1Y16 when it called at its planned stop at York.
- 66 A review of the train times passing Tallington Junction (figure 11), approximately eight miles to the north of Peterborough, showed that:
- train 1L06 passed at 10:09 hrs (running on time)
  - train 1Y80 passed at 10:11 hrs (running 4 minutes early)
  - train 1Y16 passed at 10:17 hrs (running 21 minutes late).

### Events during the incident

- 67 At 10:15 hrs, the signaller at Peterborough signal box set the route for train 1L06 from P468 signal to platform 6. At around this time, a Govia Thameslink Railway (GTR) service, train 1P83, was departing from Peterborough platform 1 towards London (figure 12).

---

<sup>7</sup> A route conductor is a train driver who is familiar with the route who accompanies a train driver who is not, to ensure that the train and route are both correctly driven. This definition has been taken from Ellis's British Railway Engineering Encyclopaedia © Iain Ellis. [www.iainellis.com](http://www.iainellis.com).

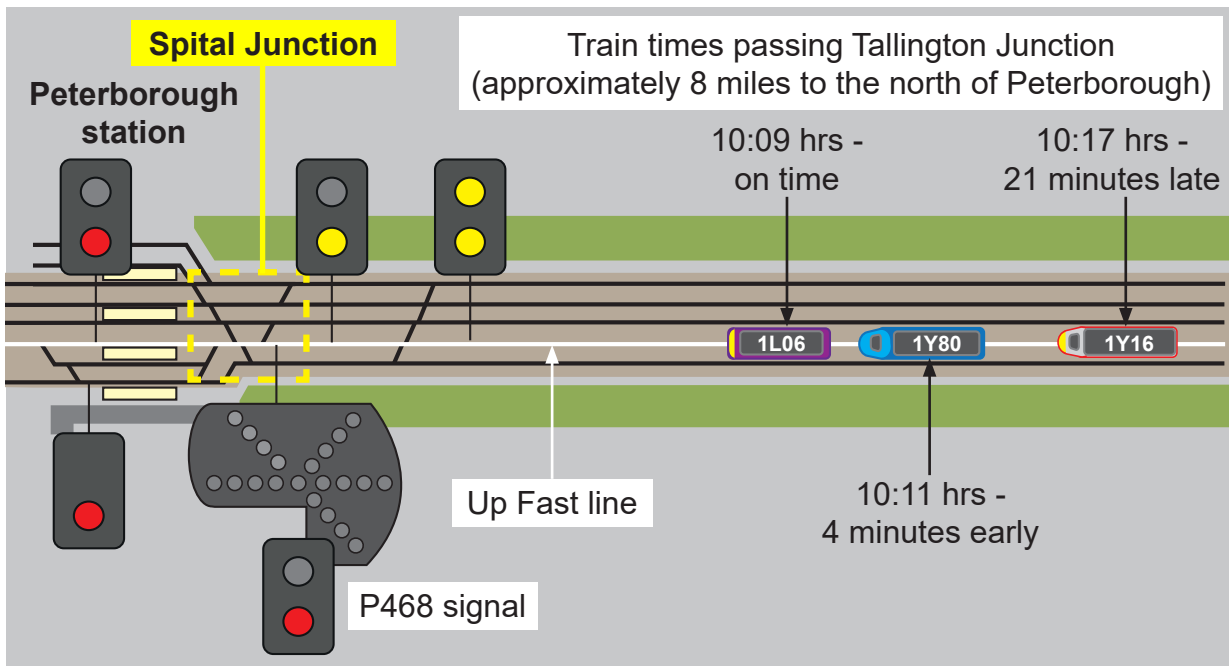

Figure 11: The three trains and their timings approaching Peterborough station from the north.

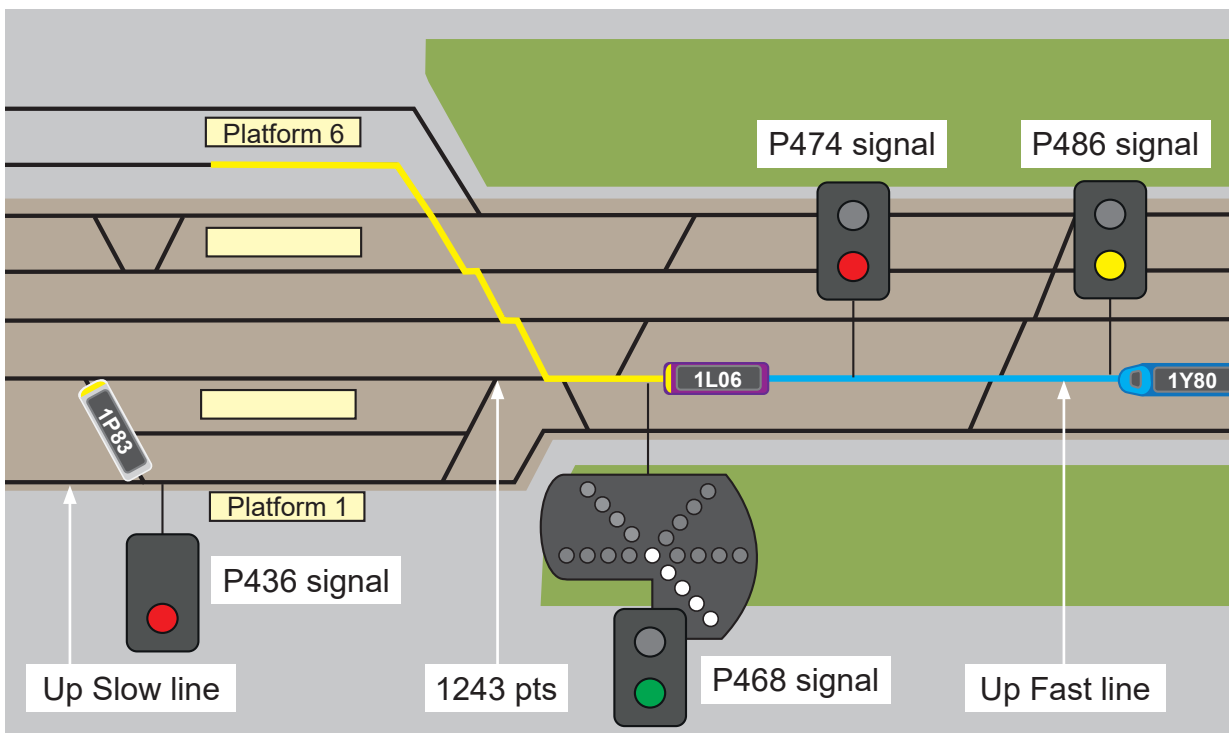

Figure 12: The position of trains 1P83, 1L06 and 1Y80 at 10:15 hrs.

68 The signaller decided to regulate train 1Y80 so that late running train 1Y16 would arrive at London King's Cross ahead of it. The signaller stated that this was to minimise delay with the build-up of trains at the throat of King's Cross station. To achieve this, the signaller planned to route train 1Y80 onto the Up Slow line at Spital Junction and to keep train 1Y16 on the Up Fast line and to stop at platform 3. Train 1Y80 would be signalled to rejoin the Up Fast line at Fletton Junction to the south of Peterborough station, behind train 1Y16.

- 69 At 10:17:02 hrs, with train 1L06 still occupying the Up Fast line, train 1Y80 was travelling at around 32 mph (51 km/h) and slowing down as it approached and passed P486 signal displaying a single yellow aspect. Train 1Y80 then occupied track circuit T7726 which inhibited P474 signal from showing a single flashing yellow aspect (paragraph 40). At this time, P474 signal was not visible to the driver of train 1Y80. Because of the proximity of train 1Y80 to P468 signal, it was prevented from using flashing yellow control, and was approach released from a red aspect (figure 13).

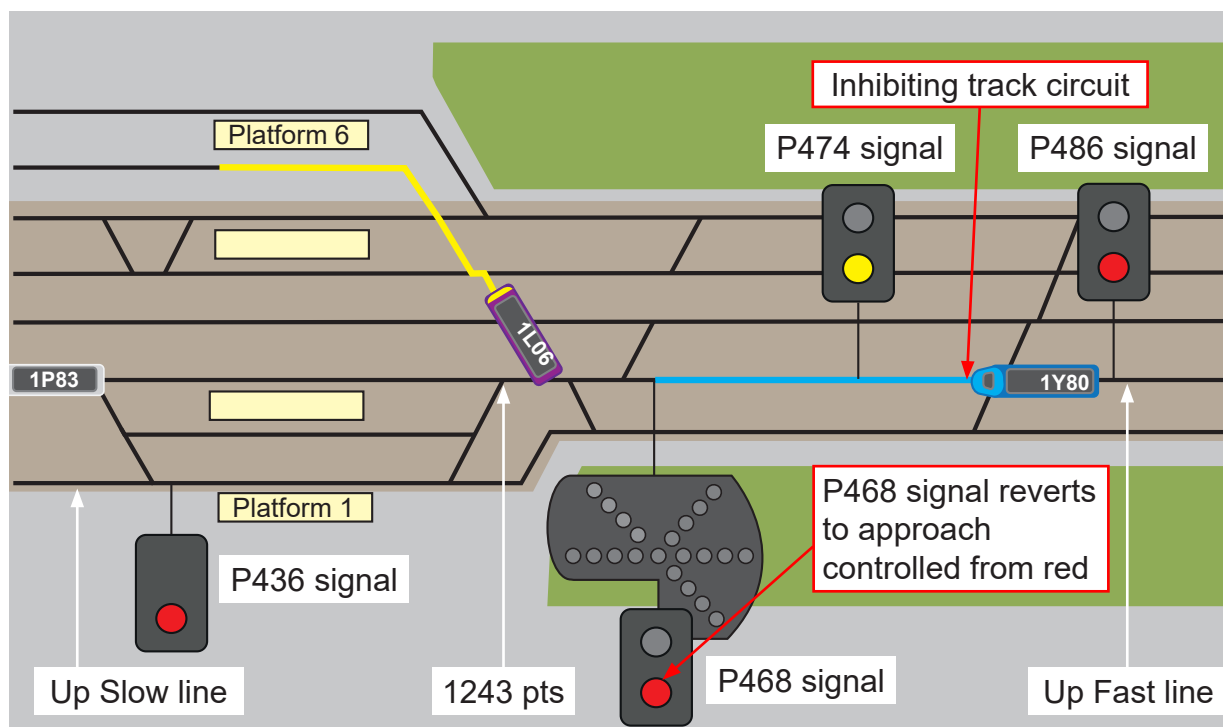

Figure 13: The position of trains 1P83, 1L06, and 1Y80 at 10:17:02 hrs.

- 70 At 10:17:08 hrs, P436 signal changed to display a yellow aspect as seven seconds earlier the signaller had set the route from this signal along the Up Slow line to the signal protecting Fletton Junction.
- 71 At 10:17:36 hrs, four seconds after train 1L06 had moved clear of the Up Fast line, the signaller set the route for train 1Y80 beyond P468 signal onto the Up Slow line to P436 signal at the end of platform 1.
- 72 At 10:18:05 hrs, train 1Y80 passed over the AWS magnet for the PSWI for the junction travelling at around 28 mph (45 km/h). The driver acknowledged the AWS warning, and the train reached the PSWI sign 15 seconds later (figure 14).

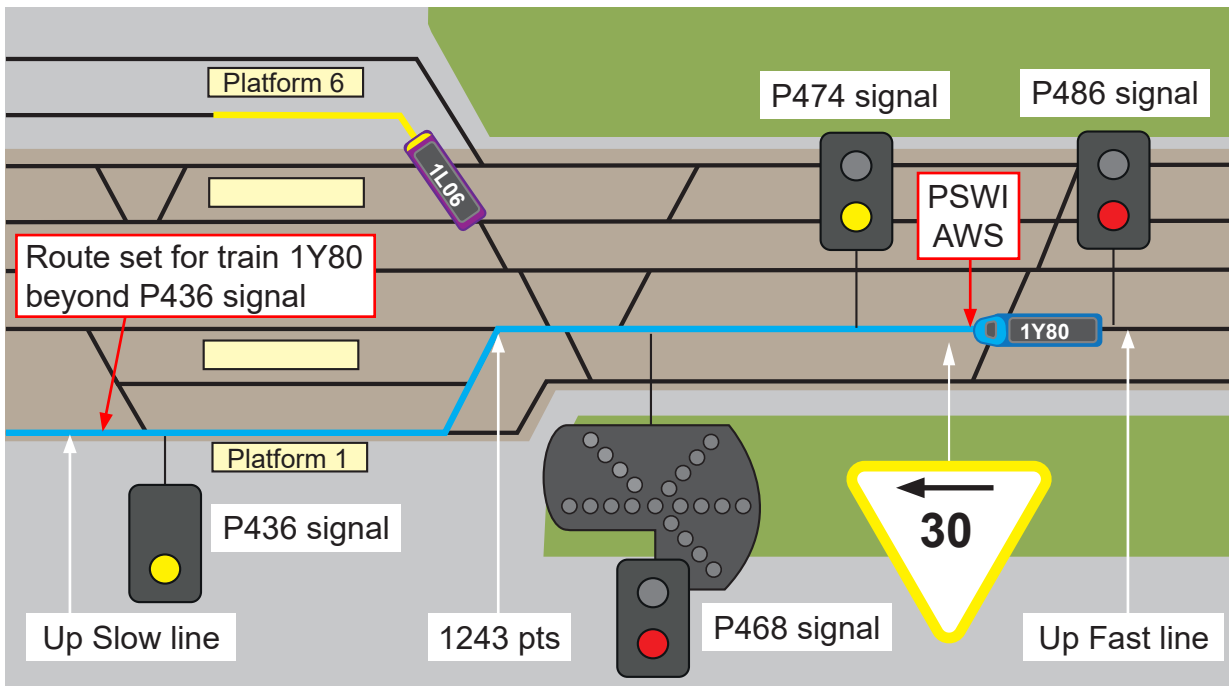

Figure 14: The position of trains 1L06 and 1Y80 at 10:18:05 hrs.

73 At 10:18:58 hrs, train 1Y80 reached track circuit T7724, having just passed P474 signal previously displaying a single yellow aspect. This started the 10-second timer which, once expired, would allow the release of P468 signal (figure 15). By this time P468 signal, which was showing a red aspect, was visible to the driver of train 1Y80.

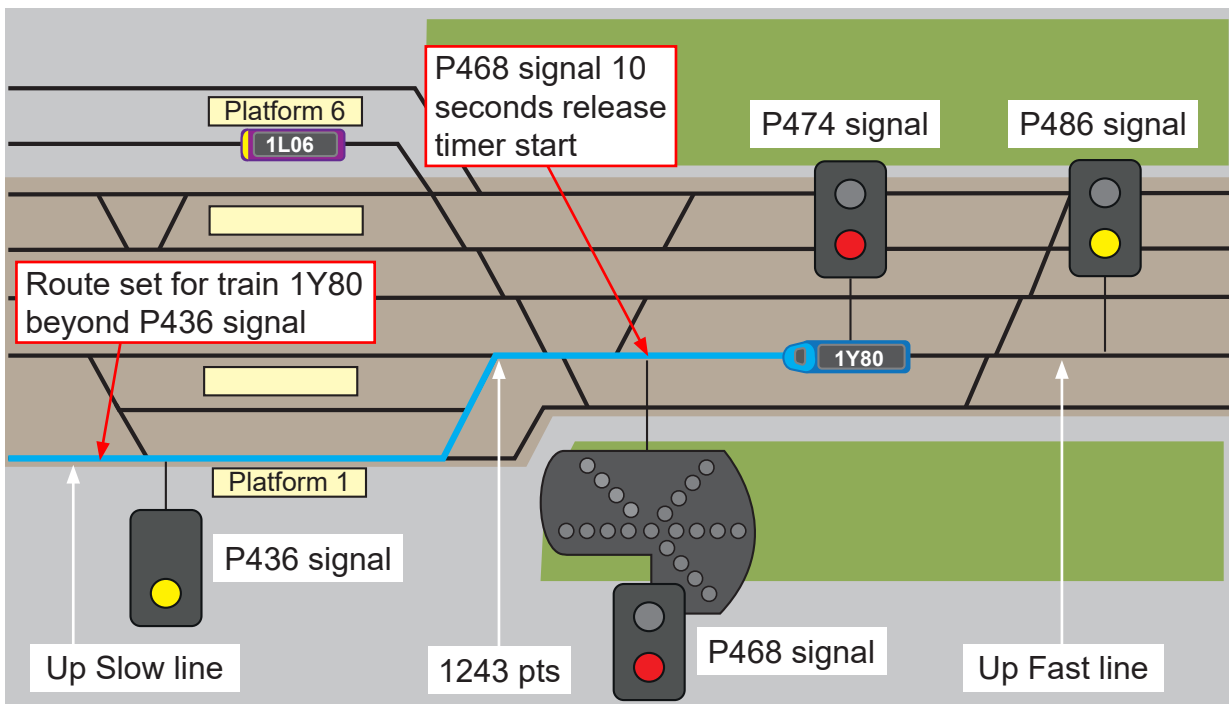

Figure 15: The position of trains 1L06 and 1Y80 at 10:18:58 hrs with 1Y80 having just passed P474 signal.

- 74 At 10:19:09 hrs, the JI for the Up Slow line to platform 1 illuminated, followed within a second by the main aspect of P468 signal changing from red to green (figure 5). The train was travelling at around 25 mph (40 km/h) and was approximately 790 metres from the signal when the aspect changed. Three seconds later and with the train approximately 760 metres from P468 signal, the driver applied full traction power to accelerate the train (figure 16). The train passed P468 signal travelling at around 64 mph (103 km/h) and was still accelerating.

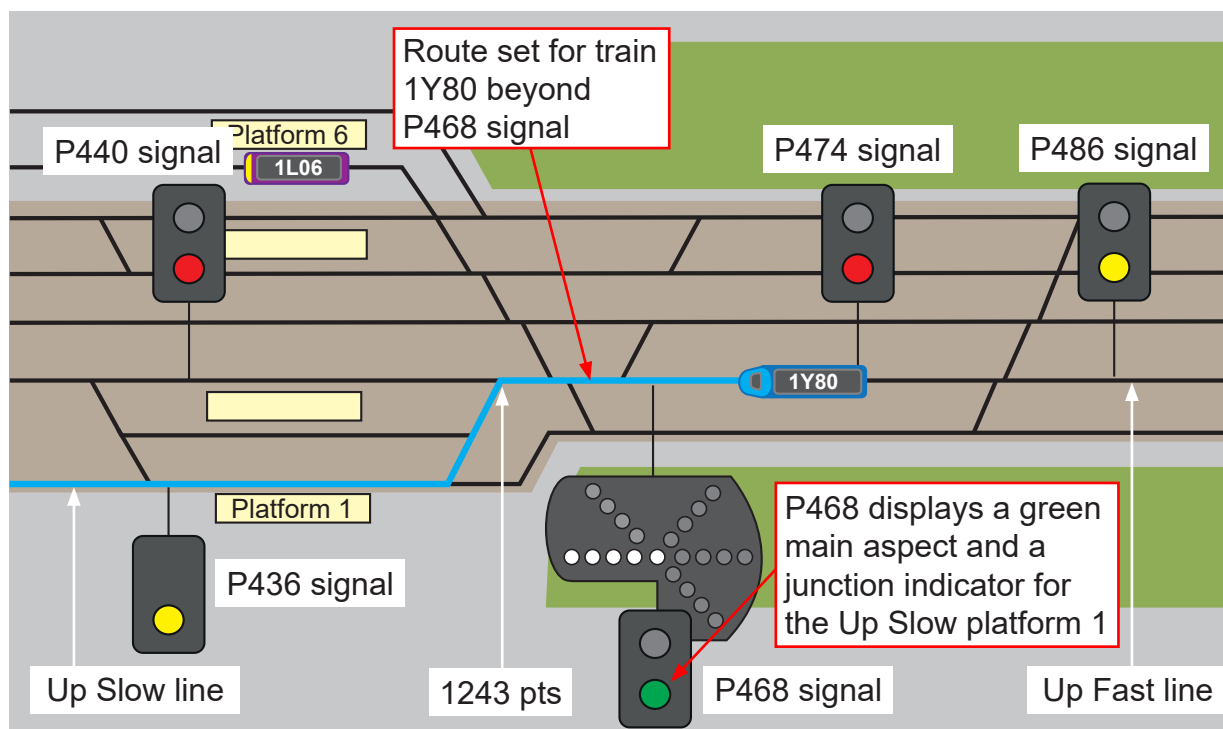

Figure 16: The position of train 1Y80 at 10:19:09 hrs.

- 75 At 10:20:08 hrs, the train was approximately 160 metres from 1243 points and had reached around 77 mph (123 km/h). The driver stated that they saw the platform banner repeater signal at the north end of platform 3 was 'on', indicating that the route for the Up Fast line through platform 3 was not set. They reacted by applying a full service brake (figure 17).

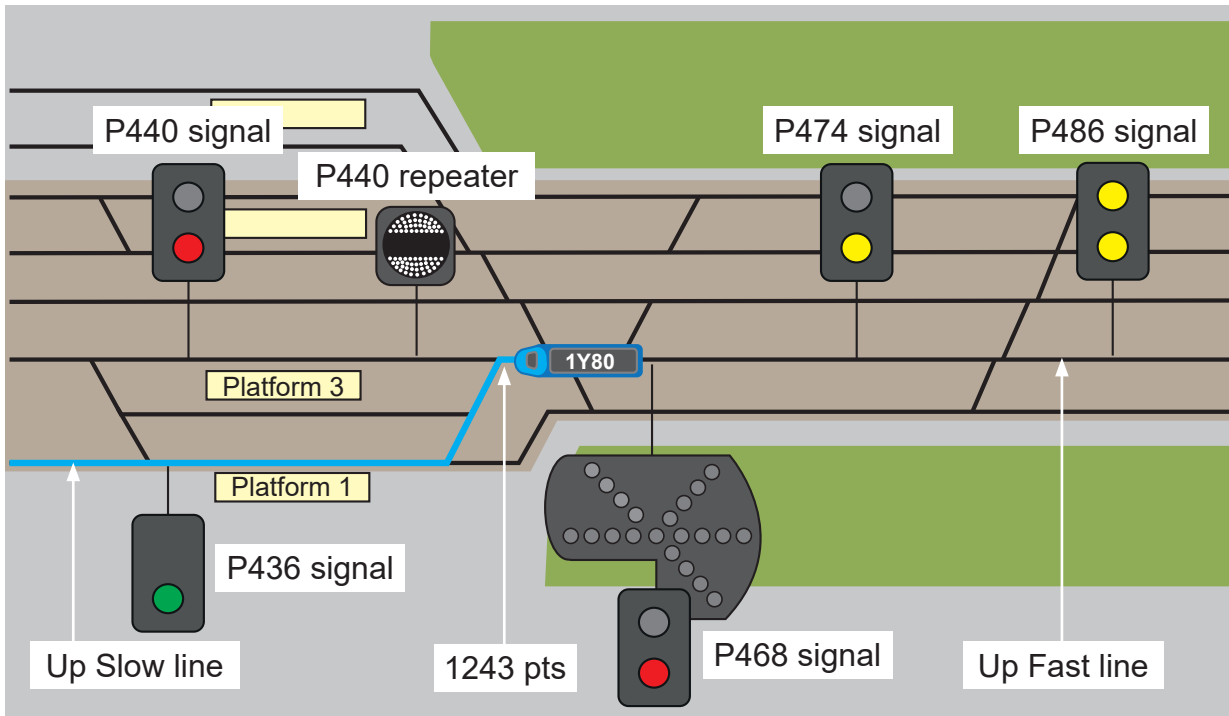

Figure 17: The position of train 1Y80 at 10:20:08 hrs.

76 At 10:20:11 hrs, the train reached 1243 points at the junction while it was still travelling at around 76 mph (122 km/h) (figure 18). The driver made an emergency brake application around nine seconds later, after the train had passed over all of the points and while it was travelling at around 60 mph (97 km/h).

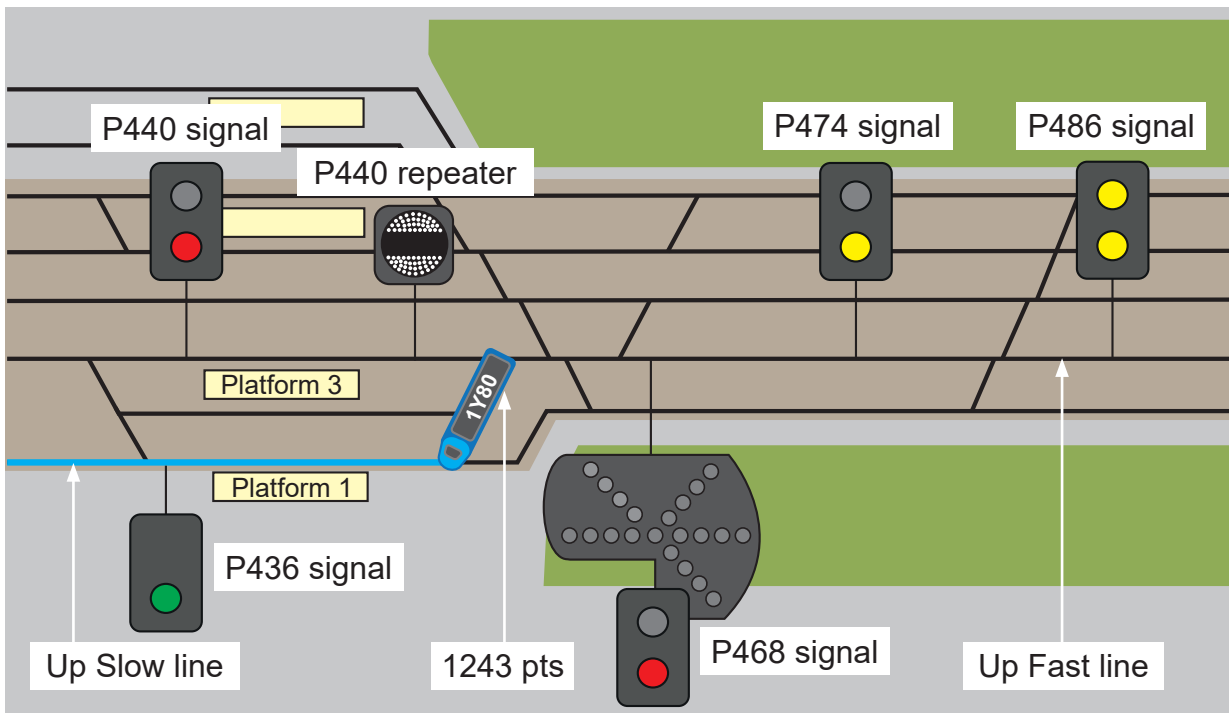

Figure 18: The position of train 1Y80 at 10:20:11 hrs.

- 77 At 10:20:40 hrs, the train stopped just before reaching P436 signal at the south end of platform 1 (figure 19). The late running train 1Y16 arrived at platform 3 around 2 minutes later.

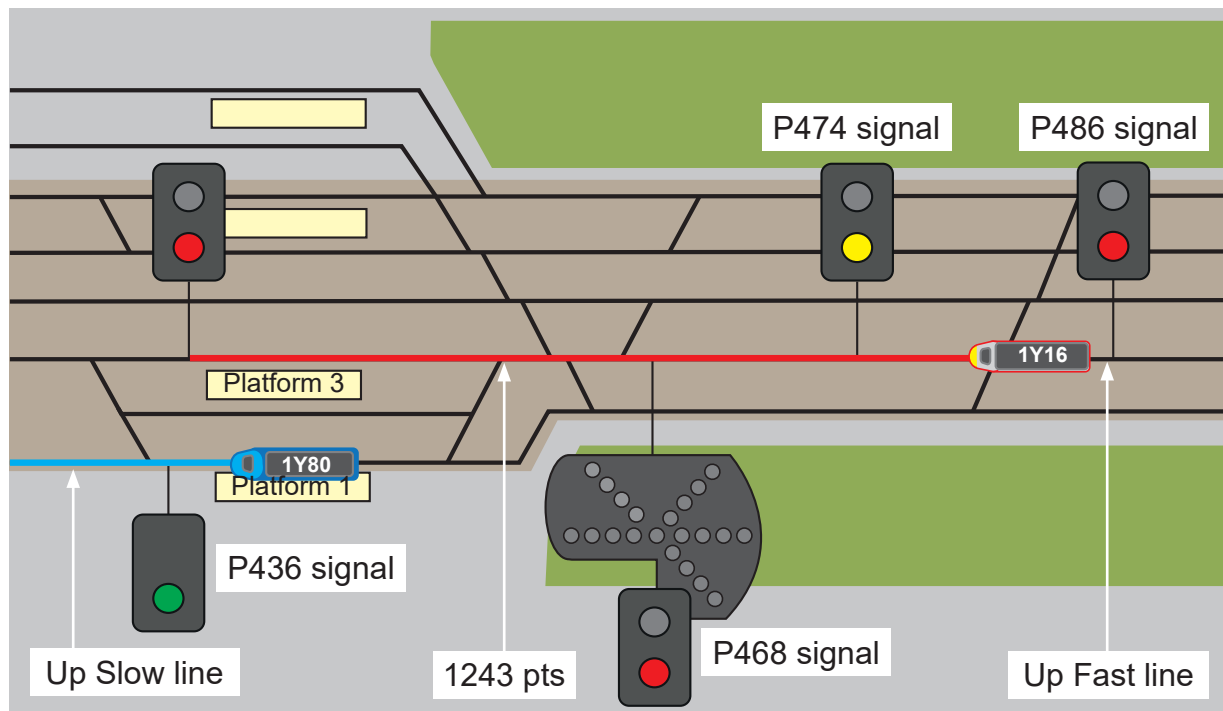

Figure 19: The position of trains 1Y80 and 1Y16 at 10:20:40 hrs.

## Events following the incident

- 78 Once train 1Y80 had stopped, the driver called the signaller to report that they had passed through the junction at excessive speed and requested that P436 signal ahead of the train was replaced to show a stop aspect. The driver requested some time to compose themselves as they were shaken by the event. The driver did not realise at this stage that they had not seen the junction indicator on P468 signal and was confused about what had happened.
- 79 The customer ambassadors checked the condition of the passengers, attending to those who had minor cuts and bruises. Details were taken from those passengers who reported injuries.
- 80 The off-duty driver who was travelling as a passenger came to assist and reassure the driver. At the request of their control room, both drivers conducted a visual check of the train from platform 1 looking for damage and none was seen. During this time, there was consideration of whether to detain passengers at Peterborough station, but once the suitability of the off-duty driver to continue the journey was confirmed, all passengers remained on the train as the decision had been made by TransPennine Express (TPE) control staff (who act as Lumo's control) to take the service forward to London King's Cross station.
- 81 The train departed from Peterborough station at 11:45 hrs, with the off-duty driver driving the train. The customer ambassadors were requested to listen for any unusual noise and vibration once the journey commenced.

- 82 Passengers and train crew were met by the British Transport Police and station management staff at London King's Cross station who took statements from some passengers and assisted with passenger care. British Transport Police breathalysed the driver who was also screened for drugs in line with the relevant rail industry post-incident standard.<sup>8</sup> Both tests returned clear results.
- 83 The train was later taken to Bounds Green depot for a full examination and no relevant damage was found.
- 84 Network Rail checked the condition of the points at the junction following the incident and reported that they had not sustained any damage.

---

<sup>8</sup> RIS-8070-TOM issue 2 'Drugs and alcohol testing for safety-critical workers' 5 March 2022.



## Analysis

### Identification of the immediate cause

**85 Train 1Y80 passed over a junction at excessive speed because the driver had controlled the speed appropriately for the through route rather than the slower, diverging route.**

### Identification of causal factors

- 86 The driver controlled the speed as if to take the through route because they did not identify that train 1Y80 had been signalled towards the diverging route. This was due to a combination of the following causal factors:
- a. The driver did not react appropriately to the junction indicator at P468 signal (paragraph 87).
  - b. The driver's awareness of the signal conditions that could be presented at this junction was not sufficient to overcome their expectation that the train was to be routed on the Up Fast line (paragraph 97).
  - c. The signalling layout and configuration at this location did not, and nor was it required to, prevent the train from accelerating towards the diverging route and reaching an excessive speed from the distance at which a proceed aspect was given (paragraph 139).

Each of these factors is now considered in turn.

### The actions of the driver

**87 The driver did not react appropriately to the junction indicator at P468 signal.**

- 88 There is no conclusive evidence as to why the driver did not react correctly to the junction indicator at P468 signal and control the train's speed appropriately for the diverging route to platform 1. The driver's exchange with the signaller immediately following the incident (paragraph 78) suggests that the driver had not seen the junction indicator. RAIB has concluded that the driver's actions almost certainly resulted from the forming of a strong expectation that their train was being routed straight ahead and so they did not notice that, or account for, the position two junction indicator being illuminated for the route into platform 1. As a consequence, this caused the driver to accelerate the train towards the maximum permitted speed for the Up Fast line through platform 3.
- 89 As the train was approaching Peterborough station, P468 signal would have been visible to the driver for more than 1000 metres (in excess of 70 seconds) before the train reached it. When it first became visible, P468 signal was displaying a red aspect as the route ahead could not be set by the signaller until train 1L06 was clear of the Up Fast line (paragraph 71). Evidence from the train's forward-facing CCTV camera, data recorder and signalling logs show that the JI illuminated to show the junction indicator for the route to to platform 1 and that P468 signal's main aspect changed to green when the train was travelling at around 25 mph (40 km/h) and was approximately 790 metres from the signal (paragraph 74).

- 90 P468 signal displayed a visually uninterrupted green main aspect and a junction indicator for the route to the Up Slow line to platform 1 for 41 seconds as the train approached it (paragraph 55). During its approach, both the main aspect and the junction indicator of P468 signal would have become more conspicuous to the driver.
- 91 Although the sun blind had been lowered earlier during the journey and the sun was shining towards the front of the train as it approached the signal, the driver stated after the incident that the conditions were not bright enough to require the wearing of sunglasses and made no allegation about the sunlight affecting the signal's visibility. Although it remains possible that the lowered sun blind may have obscured the driver's view of P468 signal as the train came very close to it, the green main aspect and junction indicator had been readable to the driver for a sufficient period to fully observe it before reaching this point.
- 92 There was also no evidence that the driver was distracted during this part of the journey or that their attentiveness was reduced due to fatigue or work underload. The driver stated that they were well rested before the journey, and their roster from the previous week indicates no issues relating to fatigue. The driver was aware that they were following a slower train and was occupied in moderating the speed of the train in response to seeing the restrictive aspects (paragraph 63). This indicates that they were engaged in the task and so work underload is unlikely to have been an issue.

#### Previous experience of the junction

- 93 Lumo services do not stop at Peterborough station and the normal route through the station is via platform 3 on the Up Fast line. In this case only the main aspect of P468 signal would be illuminated. Following the incident, the driver stated that they "always" pass through Peterborough station on the Up Fast line.
- 94 Based on their experience of previous journeys through Peterborough station (see paragraph 116), with all but one journey beyond this signal being via the Up Fast line, it is likely that the driver had formed a strong expectation that the same situation would occur on the day of the incident. Such expectations can be a significant influence on behaviour and decisions, and are a natural part of the skill acquisition process because they help to improve efficiency in performance. However, problems can occur when the external situation changes and no longer matches expectations, as the learned behaviour and decisions are no longer appropriate.
- 95 The driver reacted to the change in aspect at P468 signal approximately 3 seconds after the signal turned to green, when the train was around 760 metres from the signal, by commanding full power. Train 1Y80 passed P468 signal travelling at 64 mph (103 km/h) and was still accelerating. When the driver decided to accelerate the train using full power, the signal was within the limit of the maximum distance of readability required by standards (paragraph 51). The driver's use of full power further supports that they had, at that moment, decided that their train was to continue on the Up Fast line. This is because an application of full power on their train would not have been needed to reach the junction at the correct speed which was only slightly greater than that at which the train was already travelling.

96 Lumo told RAIB that its professional driving policy says that full power should not be applied to a train which has been signalled towards a slower diverging route. Another train operator that uses this route whose services regularly get routed over the Up Slow lines at this junction, albeit one that normally stops at Peterborough, told RAIB that, in this situation, its drivers would typically be passing P468 signal at around 35 mph (56 km/h) before removing power and coasting over the diverging route.

### The driver's awareness of the signal conditions

**97 The driver's awareness of the signal conditions that could be presented at this junction was not sufficient to overcome their expectation that the train was to be routed on the Up Fast line.**

98 Although the signalling configuration on the approach to P468 signal is designed to give advanced warnings to drivers that the route ahead is set for the divergence over the junction, on this occasion there were no advanced cues (other than the junction indicator) provided to the driver to challenge their expectation that the train was going straight ahead on the Up Fast line.

### Flashing yellow aspects

99 P468 signal is configured to be approach released from yellow for the diverging route to the Up Slow line (paragraph 34). The two signals on the approach to it, P486 and P474 signals, can show double flashing yellow aspects and a single flashing yellow aspect respectively when a diverging route has been set for a train to the Up Slow line. This is to give drivers advanced warning that the route ahead is set for the junction divergence, so that the train's speed can be controlled as it approaches the junction.

100 However, displaying flashing yellow aspects is conditional upon the location of the train approaching the signals and the status of the route set beyond the signal (paragraph 40). Because of the proximity of train 1Y80 to P468 signal, and because the route beyond P468 signal had not at that time been set, the signal was approach released from red. In this state, flashing aspects on P486 and P474 signals were inhibited. This means that no flashing aspects were shown to the driver of train 1Y80.

101 The route for train 1Y80 could not be set until train 1L06 was clear of the route beyond P468 signal. Evidence from signalling logs and the OTDR indicates that, if train 1Y80 had reached the inhibition track circuit for P474 signal 10 seconds or more later, the driver would have been presented with a single flashing yellow aspect on P474 signal, giving advanced warning of the diverging route set ahead of this train.

102 The driver had only once previously been routed on the Up Slow line (see paragraph 118) and on that journey their train had been brought to a stand at P468 signal, which had been showing a red aspect until it cleared together with the associated junction indicator. They had never experienced flashing yellow aspects on the approach to P468 signal and, on all but one previous journey, they had continued on the Up Fast line.

103 The presence of flashing aspects on the approach to the junction would have given the driver of train 1Y80 a different signalling aspect sequence to that which they were accustomed to seeing when the train was routed on to the Up Fast line. This may have alerted the driver to the diverging route set ahead of the train and challenged their expectation that the train was continuing on the Up Fast line.

#### Diverging route speed warning

104 The AWS magnet for the PSWI (paragraph 41) gives a warning to remind drivers that they are approaching a PSWI sign. This sign informs them that the first set of points for the diverging route ahead to the Up Slow lines has a maximum allowable speed of 30 mph (48 km/h).

105 This warning was given to, and acknowledged by, the driver of train 1Y80. However, a warning from this AWS is not solely given for a route being set for the junction to the Up Slow lines. This warning will always be given to trains on the approach to P468 signal except when a through route on the Up Fast line has been set and other conditions are in place (paragraph 44). Therefore, while this AWS warning may provide additional information to drivers, it can be legitimately disregarded by drivers in many operational conditions. This would have been the case on all the driver's previous journeys when approaching P468 signal displaying a cautionary or red aspect.

106 AWS is mostly used and fitted on the approach to signals to give an audible warning that the signal being approached is not displaying a green aspect. Research by RSSB<sup>9</sup> has shown that extending the use of AWS for hazards such as speed restrictions can result in drivers receiving multiple and persistent AWS warnings on a journey. In turn, this can lead to drivers anticipating the warning and cancelling it in a routine manner, without necessarily associating it with the specific hazard.

107 On the approach to Peterborough station, the driver had received a warning at P486 signal, another for the PSWI, and another at P474 signal. Using the same warning type for different types of hazards exacerbates the problem of routine acknowledgment, as this places more demands on drivers to differentiate between the warnings. Additionally, the warning for the PSWI was between those for two of the cautionary signal aspects. This sequence, and the driver's previous experiences, may have led to them not associating the specific PSWI warning with a diverging route being set ahead of the train.

108 Lumo has told RAIB that on most journeys on the Up Fast line towards Peterborough station its drivers encounter restrictive aspects on P468 and on the two preceding signals, even though the services are subsequently routed through the station on the Up Fast line. This is because, on those occasions, a route beyond P468 signal had not been set. Witness evidence indicates that the driver of train 1Y80 had previously encountered restrictive aspects on P468 and the two preceding signals.

---

<sup>9</sup> Driver reliability with extended AWS. Project T021 Summary Report. RSSB (2004).

- 109 In these cases, a warning from the AWS associated with the PSWI will always be given. This means that the AWS warning associated with the PSWI received by the driver of train 1Y80 during the approach to Peterborough on 17 April 2022 was not distinguishable from those given on previous journeys, even though on this one the train was to be routed to the Up Slow line. The warning for the PSWI did not therefore provide the driver with any distinctive information about this journey compared with the many previous journeys on this route.
- 110 The sounding of the in-cab AWS warning which had been regularly encountered on journeys through the station on the Up Fast line, together with an absence of a warning from the flashing yellow aspects on the approach, did not serve to challenge the driver's expectation.

### The driver's training

**111 The driver's training did not provide them with sufficient understanding of the conditions that could be expected at this signal. This is a probable causal factor.**

- 112 The driver did not have sufficient knowledge and experience of the various signal conditions that could be expected to be encountered at P468 signal. A greater understanding would probably have led to wider expectations about possible routing scenarios, which in turn could have challenged their expectation of where the train was being routed. Both knowledge and experience are gathered through training, the content of which is informed in part from the output of route risk assessments (see paragraph 155).

### Lumo's driver training

- 113 The driver joined Lumo in September 2020 as one of 16 apprentice drivers who started training before Lumo began passenger services in October 2021. As they had no previous train driving experience, they undertook the full driver training programme. Lumo had created a driver training plan to comply with the competence requirements of the Train Driving Licences and Certificate Regulations 2010 (TDLCR).<sup>10</sup>
- 114 The training covered all elements of driving operations including operating the train, rules and procedures and understanding how the railway infrastructure, including the signalling, worked. It was conducted using a mixture of classroom learning, self-learning, driving simulator training and accompanied train driving. The latter consisted of both observing a competent driver during cab rides and driving while being coached and observed by a driver instructor.
- 115 The training was delivered in modules with assessments throughout each of the stages. Evidence provided by Lumo indicates that the signalling course elements covered the general operation of junction signals, including junction indicators, flashing aspects, and the general risks of being diverted from fast to slow lines and of being wrongly routed.

<sup>10</sup> <https://www.orr.gov.uk/guidance-compliance/rail-guidance-and-compliance/train-driving-licences-and-certificates>.



### Driving experience during training

- 116 Lumo's driver training procedures required apprentice drivers to have completed a minimum of 175 hours of accompanied driving before being assessed for their suitability to undertake their final assessment. The driver of train 1Y80 had completed 185 hours of accompanied driving by the time they were assessed and found to be competent on 3 February 2022. At the time they were assessed, their driving experience had included 77 accompanied journeys from Newcastle Central to London King's Cross stations.
- 117 Between qualifying in February 2022 and the day of the incident they had driven 23 journeys unaccompanied on this route. Their total unaccompanied driving hours was around 330, in addition to driving to, from and within depots and some earlier accompanied journeys between Newcastle and Edinburgh.
- 118 On all but one of these journeys their train had been routed through Peterborough station on the Up Fast line via platform 3. The one exception was in December 2021, on an accompanied journey, when the train was signalled over the junction to platform 1. On this journey, the train was brought to a stand at P468 signal before it cleared to a green aspect with the associated junction indicator.
- 119 This means that the driver had very limited experience of driving through Peterborough station on the Up Slow line via platform 1. They had never encountered the situation with P468 signal clearing from red to green with a junction indicator when the train was 790 metres away, as happened during this incident. Their experience from the previous journeys via platform 3 is very likely to have led to their expectation that day.

### The driver's knowledge of the signal's operation

- 120 Although the driver's training included instruction on junction signals, including the meaning of flashing aspects at approach controlled signals, Lumo did not teach its drivers about the detailed operation of approach controlled junction signals at specific locations, or identify locations where such signals were installed.
- 121 Lumo has told RAIB that this was because this could lead to a driver making assumptions about how the signal could change and lead to errors involving anticipation and assumption. Lumo stated that during periods of accompanied train driving and route learning, trainee drivers become aware of situations that occur at certain locations, although Lumo has also stated that it teaches its trainee drivers that conditions each day may be different and assumptions should not be made.
- 122 The expectations that may influence human behaviour can to some extent be overcome either by increasing the prominence of the information in the environment (in this case, the warnings given on the approach to, and by, the junction indicator at P468 signal; paragraphs 102 and 109), or by improving the individual's understanding of the potential situations that they could face. Given the driver's very limited experience of encountering diverging routes when driving through Peterborough station, having a greater knowledge and understanding that their train may be diverted at times onto the slow lines may again have challenged the strong expectation that the train was to take the straight-ahead route, as they almost always had done.

- 123 Lumo's training and risk management regime includes developing drivers' non-technical skills. Non-technical skills are defined by RSSB<sup>11</sup> as the social, cognitive and personal skills that can enhance the way staff carry out technical skills, tasks and procedures. One of the non-technical skills techniques taught by Lumo to its drivers during training is the use of risk triggered commentary while driving. This uses the process of verbal commentary and repeating back the potential risk ahead and the actions the driver needs to take, before reaffirming them, which acts as a check. The technique needs the early identification of a potential risk to trigger it. Lumo told RAIB that, in their opinion, the use of risk triggered commentary could have helped to prevent this incident.
- 124 The driver has stated that they were using risk triggered commentary during the journey. However, because the driver did not have the knowledge of the associated risk at P468 signal, gained either from teaching or experience, and together with the expectation of going straight ahead, they did not perceive that there was a risk. The driver has stated that they did not see the need to use risk triggered commentary at this location. Moreover, the guidance<sup>12</sup> from the Office of Rail and Road (ORR, the safety authority for the mainline railway in Great Britain) on developing and maintaining staff competence advocates that the development of non-technical skills should be integrated into the wider competence management system and should not be seen as a substitute for good system design.

### Route knowledge

- 125 Lumo had created a route learning strategy document in support of its driver training plan. This was based upon guidance provided in Rail Industry standard RIS-3702-TOM 'Management of route knowledge'.<sup>13</sup> It used this, together with a review of the risks present on the route, to create its training plan for its drivers to learn and retain route knowledge.
- 126 Route learning included providing drivers with access to route maps, cab riding during accompanied journeys and recorded video footage. Lumo also used virtual reality learning, but this was limited to part of the route closer to King's Cross station. Both the virtual reality learning and the recorded video footage of the route did not show the signals in all their possible states and did not include anything specific regarding the various routes that could be taken at P468 signal.
- 127 Part of the training involved spending time on simulators. These were used for both training and driver assessment purposes. The driver involved in the incident undertook three simulator sessions during their training. The first was used as a general familiarisation of train control, the second was for specific training and the third was used for driver assessments. The specific training was focused on out-of-course events. These sessions included training on handling events and incidents such as low rail adhesion conditions, monitoring and responding to train alarms and emergency communications.

---

<sup>11</sup> <https://www.rssb.co.uk/en/safety-and-health/improving-safety-health-and-wellbeing/understanding-human-factors/non-technical-skills>.

<sup>12</sup> <https://www.orr.gov.uk/media/10885/download>.

<sup>13</sup> RIS-3702-TOM 'Management of route knowledge', issue 3, March 2020.

- 128 Lumo did not have a simulator of its own, so it used those belonging to other train operators within FirstGroup. As a result, the simulated route used for training was not one over which Lumo operated. Lumo has stated that there were no conditions covered in these simulator sessions which were comparable to those involved in this incident (that is, being diverted from a usual route).
- 129 The driver's route knowledge was progressed and assessed throughout the training period. Lumo has provided evidence that the driver was tested on their knowledge of P468 signal during the final assessment on 3 February 2022 before qualifying. The question asked whether a driver could accept a proceed aspect from P468 signal with a junction indicator at the number 4 or number 5 positions (those junction indicator positions directing a train towards platforms 4 or 5). The driver correctly answered that they could not, as these were only for stopping services at Peterborough station and that there was no route back to rejoin the Up Fast line.
- 130 Although the answer to this question showed that they were aware of P468 signal and the routes available beyond it, the question relates to the risk of being wrongly routed at the signal (as opposed to the risk of being diverted towards an unexpected but acceptable route with a significant speed differential). The question addresses an operational risk rather than one directly related to safety. The safety risk associated with this signal was not fully considered because Lumo's route learning and route risk assessment processes had not considered it (see paragraph 155).

#### The driver's hours before qualifying

- 131 Lumo's operational management procedure for its training of drivers stated that its trainee drivers should undertake a minimum of 175 hours of accompanied driving before being considered for a final assessment. The final assessment was to review whether a driver was ready to undertake the final competency examination before qualifying. The driver involved in the incident had undertaken 185 hours of accompanied driving before their final assessment on 3 February 2022.
- 132 The operational management procedure that contained Lumo's training procedure for drivers was originally issued in March 2021 and was reviewed as part of its safety validation process in September 2021, before Lumo became fully operational.
- 133 In support of its case for specifying its minimum driving hours before final assessment, Lumo considered a duration of 225 hours of accompanied driving. Lumo stated to RAIB that many train operating companies used 225 hours of accompanied driving as their minimum duration and RAIB found that this appears to have been based on industry guidance within a now withdrawn Association of Train Operating Companies (ATOC) Approved Code of Practice<sup>14</sup> dating to the early 2000s.

---

<sup>14</sup> ATOC/ACOP003 Approved Code of Practice, 'Train driving – Basic training, assessment and post qualifying monitoring', issue 1, 3 April 2000. This was withdrawn around 2003, and subsequent documents on this topic did not specify a minimum number of hours to obtain competency.



- 134 Current guidance allows train operating companies to determine their own minimum durations in consideration of the complexities of their operations and Lumo subsequently prepared a safety validation to justify a minimum of 175 hours of accompanied driving before a driver was considered for a final assessment. In comparison, another train operator running services on this route, albeit one operating on additional lines and with more station stops, has a minimum requirement of 300 hours.
- 135 In its justification for the number of pre-qualification driving hours, Lumo considered factors such as the limited route over which it was to operate, the small number of station stops, its use of a single type of traction and rolling stock and improvements in safety features of both the infrastructure and on its trains. Through the regular assessments of its trainee drivers, Lumo was also monitoring their progress in gaining competency to confirm that the reduction in driving hours was acceptable.
- 136 Lumo stated that, due to limited access to cabs because of COVID restrictions, trainee driving could not be carried out as originally planned. During the periods when access to driving trains was not available, trainees undertook other tasks such as route briefing, briefings on out-of-course movements, updating knowledge previously gained in training and an additional simulator session.
- 137 If the driver had undertaken more driving hours on this route before being assessed, then it is possible that they would have had an increased opportunity to see P468 signal showing a variety of aspects, including the one encountered during the incident. While this may have improved their knowledge of the signal's operation and helped to counter expectations of being set a route only on the Up Fast line, there is no guarantee that this would have occurred. In this context, it is notable that they had driven the route for more than 140 hours unsupervised since qualifying (and over 300 hours in total including during training) and had not encountered the signalling conditions met on the day of the incident.
- 138 As such, RAIB has concluded that although the minimum number of pre-qualification driving hours required by Lumo cannot be entirely discounted as a factor, it is unlikely to have altered the outcome in this incident.

### The signalling layout and configuration at Spital Junction

**139 The signalling layout and configuration at this location did not, and nor was it required to, prevent the train from accelerating towards the diverging route and reaching an excessive speed from the distance at which a proceed aspect was given.**

### Acceleration of the train

- 140 Around three seconds after the proceed aspect had been given by P468 signal, the driver applied full traction power to accelerate the train (paragraph 74). The train was approximately 760 metres away from the signal when this occurred. By the time the driver realised that something was amiss (paragraph 75), the train was 160 metres from the junction and travelling at 76 mph (122 km/h). The driver reacted by applying the full service brake on the train. Despite this, the train traversed the first set of points at 76 mph (122 km/h) and came close to a speed which would have resulted in the train overturning. The post-incident dynamic analysis predicted a high risk of overturning at speeds of more than 75 mph (120 km/h) (paragraph 7).

- 141 Class 803 trains are capable of relatively high acceleration rates. RAIB was given data and analysis from the Railway Performance Society<sup>15</sup> for comparative purposes. This allowed the acceleration of the class 803 forming train 1Y80 to be compared to that of a 10-vehicle High Speed Train (HST) set made up of two class 43 locomotives and eight passenger vehicles at the same location and over the same distances. The HST was one of the higher performing passenger rolling stock classes operating on that route at the time the current signalling scheme at Peterborough was designed, installed and commissioned (paragraph 45).
- 142 Although the speed reached by the class 803 was greater over the distance, an HST was still predicted to reach more than 65 mph (105 km/h). While the risk of an HST derailing in these circumstances has not been assessed, it would still be travelling through the junction at more than twice the permitted maximum speed in the circumstances of this incident. It is also the case that a single locomotive running light with no carriages (as was the case at Bletchley Junction in 2012 – see paragraph 189) could, over the same infrastructure, reach speeds in excess of those reached by either the class 803 or HST sets, with a high risk of derailment.

### *The signalling layout at the junction*

- 143 The train reached a speed of 76 mph (122 km/h) before the driver removed power. The train at that time was around 160 metres from the junction. If the driver had not noticed the condition of P440 signal's banner repeater signal (at the north end of platform 3) and continued to accelerate, the train's speed over the junction would have been greater and would have likely reached a speed at which overturning has subsequently been predicted to occur.
- 144 The driver applied full power to the train when it was around 760 metres on the approach to P468 signal and was travelling at around 25 mph (40 km/h). The train then travelled for approximately 540 metres beyond P468 signal before the driver commanded an application of the train's brakes. The total distance travelled over which the train accelerated (1,300 metres in this case), and the acceleration performance of the train, made possible the speed that was reached at the junction.
- 145 P468 signal is located 700 metres from the junction which is close to the maximum distance of 800 metres defined in the relevant standards (paragraph 51). P468 signal is positioned at this distance because of infrastructure restrictions, principally the overbridge in front of which the signal is located. Repositioning the signal beyond the overbridge and closer to the junction would restrict its view to drivers as well as reducing the safe overrun distance for braking. It would also mean that other signals either side of it would have to be repositioned (paragraph 60).

---

<sup>15</sup> <https://www.railperf.org.uk/>.

146 The junction itself is in an area of very restricted space. The effect of this on the layout of the junction is that relatively small radius turnouts are necessary for the diverging routes which have a low permitted maximum speed. Increasing the speed over the junction from the Up Fast to the Up Slow lines would therefore require remodelling the track at the north end of the station. The addition of the flashing yellow aspect sequence controls for the routes from P468 signal (paragraph 45) was considered to have minimal impact on future resignalling works in the area as it was foreseen that future works would include an upgrade to the junction to give it an increased maximum permitted line speed of at least 40 mph (64 km/h). Although track remodelling is now underway on the north end, down side (northbound tracks) of Peterborough station, the up side (southbound tracks) remains as it was in 2013.

#### The signalling configuration at the junction

147 In 2012, Network Rail consulted with the operators of passenger and freight trains on its proposal to add the flashing yellow aspect sequence controls to P468 signal considering that it required a deviation from standards (paragraph 46). The issue to be addressed, as stated in the meeting minutes, was that P468 signal, in its then operational state of being approach released from red, was leading to trains having to accelerate towards, and then brake in advance of the diverging junction. The stated benefit of the proposed change was an improvement in journey time performance by a reduction of up to 90 seconds for trains travelling from the Up Fast to the Up Slow lines.

148 The relevant train operating companies were asked to consider the risk to drivers of the introduction of the flashing yellow aspect signal controls. Their collective response was that, by that time, drivers no longer considered that flashing aspects were solely for high-speed junctions and their use for lower speed junctions was more prevalent, and that drivers would use their route knowledge to drive appropriately.

149 Other issues were discussed including the positioning of the PSWI AWS magnet and the location on the approach at which the signal would revert to its approach released from red controls, and all were accepting of the change proposal.

150 Because of the conditions present when train 1Y80 approached it, P468 signal was operating on the principle of approach released from red (paragraph 69). This was in the state that it had been before approach release from yellow controls were introduced in 2014. The only difference was that the release of the signal by occupation of the timer track circuit (paragraph 33), which had previously been 20 seconds was now 10 seconds. The difference of 10 seconds was stated as contributing to the performance benefit cited in the deviation application made so that flashing yellow aspect sequence controls for the routes from P468 signal could be added (paragraph 46).

- 151 If this timer's duration had been maintained at 20 seconds and the same conditions existed as at the time of the incident, then train 1Y80 would have been around 100 metres closer to P468 signal when it changed to green, making the JI more discernible to the driver when it illuminated. However, even if the duration of this timer had been increased, marginally different conditions, such as a slower approach speed of train 1Y80, could have resulted in the signal's status changing when a train was at the same distance from it as in this incident. Therefore, it is not possible to say what, if any, effect this timing change would have had on the driver's expectations of which route the train was taking.
- 152 The additional 10 seconds, and this small reduction in distance over which the train would have accelerated, could have led to train 1Y80 travelling over the junction at a slightly lower speed. However, a similar use of full traction power would still have seen the train achieve a speed greatly exceeding that permitted at the junction.
- 153 Therefore, the changes introduced in 2014 did not materially affect the likelihood of this incident occurring, other than perhaps the driver having the view that, should the train be diverted at the junction, they would have approached with one or more signals displaying flashing aspects.
- 154 What is clear, however, is that there are no engineered controls in place to prevent a train from overspeeding towards a junction once a clear aspect is given by a junction signal. The sole risk mitigation, and that which was stated in the consultation assessment when the signalling arrangements were changed, is that drivers must see and respond to a signal and rely upon their route knowledge.

## Identification of underlying factors

### Lumo's assessment of the safety risks at junctions

**155 Lumo had not assessed the risk associated with trains being unexpectedly routed on to a slower, diverging route at this location, and hence had not adequately mitigated the risk.**

- 156 Lumo had created an operational management procedure for its driver route learning and retention policy. This document was partly based upon the requirements and guidance in Rail Industry standard RIS-3702-TOM and also covered areas which were outside of this standard. This states that:
- route risk assessments shall be undertaken to '*identify the information staff need to know to operate safely and effectively over a specific route.*'
  - drivers should know '*the signals, names and types of running line, and permissible speeds associated with junctions where drivers may be required to take a diverging route.*'
- 157 The standard also contained guidance on how to undertake a risk assessment in support of defining and delivering required route knowledge to drivers. This included identifying the tasks, the risks and their consequences, and also the route cues.

- 158 To manage its training programme for drivers, Lumo created a risk-based training needs analysis document. This was founded on a generic review of its train operations and the associated hazards. With assistance from other train operators, including those within FirstGroup, Lumo had identified high-level hazards during a hazard and operability study (HAZOP). Each hazard was cross-referenced to the training modules created for its new drivers. The module on signalling was included in this (paragraph 115).
- 159 In support of driver route learning, Lumo created route learning briefing documents for its drivers. The documents were issued to all operational staff, including drivers and their trainers, and it was used to assist in gaining, and retaining, route knowledge. The briefing document for Lumo's route from Doncaster (South) to King's Cross was at version 1.4 when passenger operations began and was current at the time of the incident. Information in this document was based upon route risk assessments by its own staff, and from some of the other train operators running services over this route.
- 160 The document contained an overview of the route, route information, local instructions and station details. Other sections included descriptions of important junctions on the route to be aware of, signal risks and route hazards. Relevant content is summarised below:

'Key junctions and associated speeds'

Sixteen junctions on this section of the route had been identified. Thirteen of these had the associated main line and diverging junction speeds stated. Three junctions, one of which was Spital Junction, did not have any speed reduction values associated with them, even though it had one of the largest speed differentials on the route. The sole risk identified at Spital Junction was an operational risk of being wrongly routed to the down side lines and not being able to return to the Up Fast line, rather than the risk of overspeeding towards the junction.

'Signal risks identified'

This section of the document included signals such as those with a known signal passed at danger (SPAD) risk, risk of being misread or at risk of being read through. No junction signals had been identified which had a high risk of overspeeding, despite some signals, such as P468 signal, having a long distance between the point at which the junction signal could be seen to clear to a green aspect and the junction itself. Neither did it list any signals, such as P468 signal, in locations with a large speed differential between the main and diverging routes.

'Route hazards'

In the version of the briefing document that was current at the time of the incident, 28 route hazard locations were listed in a table. The up direction at Peterborough, with the associated risk of being wrongly routed to the non-electrified lines on the down lines, was included. A column in the table recorded the control measures Lumo had chosen to mitigate each hazard, although none of the hazards had been ranked to show their level of risk or were given a priority. The control measure associated with the wrong routing hazard identified at Peterborough referred to the question asked of drivers on their route assessments (paragraph 129). It also stated that training briefings and its professional driving policy were control measures, including the use of risk triggered commentary. Against most of the listed hazards, non-technical skills were cited as additional control measures.

- 161 Although most junctions that had been identified as being a route hazard had their associated speeds stated, up to the time of the incident, there was no consideration of those junctions at risk because of the large speed differential between through and diverging routes. Lumo has stated that while the specific risk of the signalling at Spital Junction was originally not documented, such a risk is present at most locations where trains are routed from fast to slow lines. Lumo has stated that this risk is typically covered by driver instructors during the training, talking about the generic risk of overspeed at junctions due to the number of locations where this is present along the East Coast route.
- 162 However, certain junctions remain at greater risk than others and warrant highlighting as a hazard. There is, for example, a greater risk of overspeeding where there is both a large distance between the point where a driver is given a clear aspect and the junction and/or where there is a large speed differential between routes at junctions. There are also no engineering controls to prevent trains from overspeeding once a clear aspect has been given by a junction signal which is approach controlled (see paragraph 170).
- 163 Following this incident, Lumo reviewed its route risk assessment and its briefing documents. The route hazards section in this revised version subsequently identified 43 locations, 14 of which were junctions, with the speeds between the main and diverging routes stated. Six of these were at locations where a large speed differential exists between the main and diverging routes, with the approach to Peterborough in the up direction having the greatest differential speed of those junctions identified.



## Network Rail's risk assessment of overspeeding at certain junctions

### **164 Network Rail does not control the risk of overspeeding at locations where there is a long distance between the approach controlled protecting signal and the junction itself, once a proceed aspect has been given to drivers.**

- 165 Applying approach controls to junction signals, by setting signals on the approach to restrictive aspects, alerts drivers to take action to reduce the train's speed. This is based on drivers using their route knowledge to decide on the appropriate train speed after interpreting the indications given by these signals. This controls the risk of overspeeding at junctions to a considerable degree. However, once a junction signal has cleared to a proceed aspect, there are no further engineering controls to prevent a train from reaching an excessive speed at the junction. The consequence of any overspeeding can be increased at locations where there is a long distance from where the driver receives a proceed aspect and the junction itself, where there is a large differential in speeds between the main and diverging routes, and with trains which have a high acceleration capability.
- 166 P468 signal and the two signals preceding it, P486 and P474, are fitted with the Train Protection and Warning System (TPWS). TPWS was first developed by British Rail in the mid-1990s as an interim measure to address the risk arising from trains passing signals at danger until a suitable automatic train protection (ATP) system could be developed and implemented across the network.
- 167 TPWS is fitted at signals which can show a red aspect to protect crossing or converging movements on passenger lines and certain other conflicting movements. The system is also used to enforce the observance of speed restrictions at specific plain line locations where no signalling controls exist and to control the speed at which trains approach buffer stops. TPWS is not a failsafe signalling system; it is designed to reduce the likelihood and consequences of an undesirable event. It is also not intended to intervene across the full range of train speeds.
- 168 TPWS uses radio frequency transmitters (known as 'loops') placed between the rails. When used at signals, a pair of loops is placed at the signal itself. This is known as a train stop system (TSS). These are energised when the signal is showing a red aspect. The TPWS equipment installed on the train consists of a TPWS receiver, a combined AWS/TPWS control unit and a TPWS visual indicator in the cab. Should a train pass over the loops when they are energised, the TPWS equipment on the train will detect this and generate an emergency brake demand. The driver will receive a visual indication<sup>16</sup> that the brake demand has occurred and will be required to acknowledge the demand as part of resetting the system.
- 169 At signals fitted with TPWS and on the approach to speed changes or buffer stops, another pair of loops is placed at a specified distance on the approach to the signal, speed change or buffer stop; this is known as an overspeed sensor system (OSS). The distance between the OSS and the signal, speed change or buffer stop is calculated to stop an approaching train wherever possible, or to at least reduce its speed, before any conflict point is reached. The OSS loops are activated if the associated signal is showing a danger aspect or are permanently activated at speed changes and on approach to buffer stops. A further set of OSS loops may be fitted on approach to a signal to provide additional overspeed protection. This configuration is known as TPWS+.

<sup>16</sup> Newer versions of TPWS also include an audible alert.

170 When a signal is showing a proceed aspect, TPWS, TSS and OSS loops are de-energised and the system is inactive. Therefore, there are no hardware controls to prevent a train from overspeeding towards a junction once the junction signal has cleared. The control of the train's speed is then solely dependent upon the driver's observation and reaction to the signal's aspect and any AWS warning given, together with their route knowledge.

### [The Railway Safety Regulations 1999](#)

171 The Railway Safety Regulations 1999<sup>17</sup> came into force on 30 January 2000. Regulation 3 originally required railway organisations to fit an appropriate train protection system before 1 January 2004 to mitigate the risks due to trains passing signals at danger and overspeeding at speed restrictions. Following the 1999 Ladbroke Grove accident in which 31 people died,<sup>18</sup> the deadline for fitment of such systems was brought forward to 2003 by the Health and Safety Executive (HSE) who were at that time the safety regulator for the mainline railways in Great Britain.<sup>19</sup>

172 During the mid-1990s the infrastructure managers of the mainline railway in Great Britain (British Rail and subsequently Railtrack), had developed and tested the system which would become TPWS (paragraph 166). As TPWS was the only system available which could be implemented on the scale required before the compliance date contained in the regulations, fitment of TPWS was rolled out across the mainline rail network in Great Britain.

173 In 2003, Network Rail requested an exemption from the regulations for certain situations.<sup>20</sup> This included permissible speed restrictions at diverging junctions which were equipped with approach control signalling. It listed a number of reasons for its exemption including the design limitations and complexity of using TPWS in these locations. Network Rail also regarded approach control signalling as an effective risk control for trains approaching junctions.

174 HSE granted this exemption. It stated that it agreed with the cost/benefit study submitted by Network Rail, and that any funding was to be spent instead on the fitment of TPWS+, to provide protection against SPADs for trains travelling at higher speeds.

175 The reasons submitted by Network Rail for the exemption only considered the speed of trains on the approach to a junction signal. It did not specifically consider the risk of trains overspeeding once the junction signal was released to show a proceed aspect, as occurred in this incident. Although approach control signalling is used as a means of indirectly limiting a train's speed on the approach to a signal, there is no further protection offered by the signalling system once that signal is showing a clear aspect.

---

<sup>17</sup> <https://www.legislation.gov.uk/ukxi/1999/2244/made>.

<sup>18</sup> 'The Ladbroke Grove Rail Inquiry Report', The Rt Hon Lord Cullen PC, HSE, 2001. Available at <https://www.railwaysarchive.co.uk/eventsummary.php?eventID=142>.

<sup>19</sup> The Railways Act 2005 transferred responsibility for railway-related health and safety matters from HSE to the ORR.

<sup>20</sup> <https://webarchive.nationalarchives.gov.uk/ukgwa/20130903201608/http://www.rail-reg.gov.uk/server/show/ConWebDoc.8864>.



176 Network Rail's signalling review report following this incident suggests that it may be beneficial to use TPWS to control overspeed at the junction, especially considering the long distance between the signal and the junction and that there is already a deviation from standards existing for this signal because of the large speed reduction involved (paragraph 46).

## Factors affecting the severity of consequences

### Luggage storage

**177 Half of the passenger injuries originated from the luggage stowed in the overhead luggage racks falling on them.**

178 RAIB's review of the train's internal CCTV and the descriptions of the injuries sustained by passengers concluded that half of the injuries were caused by luggage falling from the overhead luggage racks as the train went over the junction (figure 20).



Figure 20: Luggage falling from the overhead racks during the incident.

179 Lumo offers less space for passengers to store their luggage in floor-mounted luggage stacks compared to other long-distance operators of the same train type (such as the Great Western Railway (GWR) class 800/0 and LNER classes 800/1 and 800/2 units).

180 Lumo trains have three luggage stacks (figure 21) on a five-car train, whereas there are eight luggage stacks on a five-car LNER/GWR train. In common with LNER/GWR, Lumo trains also have two storage areas for either one or two bicycles or larger luggage. Lumo advised RAIB that it had repurposed the two bicycle storage areas in its trains to be bulk luggage storage areas by December 2021. All fleets of Hitachi AT300 trains are fitted with the same design of overhead luggage racks above passenger seats.

○ Luggage stacks

□ Luggage storage areas



Figure 21: Luggage storage stacks and storage areas on Lumo's trains.

- 181 Before starting operations, Lumo recognised that the carrying of luggage might become a problem. To try to address this, and following guidance provided by RSSB in one of its research projects,<sup>21</sup> Lumo created an on-board luggage policy, similar to those used by airlines, but with no specified weight restrictions. This was aimed at limiting the amount and size of luggage that passengers could bring on board its trains. The policy allowed a maximum of one small bag or holdall (although no dimensions were specified) to fit under the seat or to be placed on the overhead luggage rack, and one suitcase with a maximum size of 63 cm x 41 cm x 27 cm. This case was to be placed in one of the three carriage luggage stacks or in the bulk luggage storage areas.
- 182 To help its passengers follow the policy, Lumo also offers a luggage courier service, but stated that the uptake on this service has been slow, particularly as it is a service that has to be paid for. Although Lumo customer ambassadors may invite passengers to use the bulk storage areas to store luggage, this might not always be desirable for passengers as their luggage may be distant from them and will be out of sight. In addition, it is difficult for any train operator to regulate the amount of luggage a passenger brings on board as the National Rail Conditions of Travel for all train operators allow three items of personal luggage per person at no extra charge.
- 183 Lumo was finding that its on-board luggage policy was difficult to implement effectively and that, in practice, passengers bring luggage that they need to carry with them on board a train. As there is limited amount of space available to stow this luggage in luggage stacks on a Lumo train, quite large and possibly relatively heavy luggage will often be stowed in the overhead luggage racks, as was the case on the train involved in this incident.
- 184 The overhead racks can accommodate a case greater than the maximum size of suitcase described in Lumo's luggage policy. However, such a case (or larger) will overhang the edge of the racks as was the situation for some of the luggage on board train 1Y80 during the incident (figure 22). The racks, although deep, are not designed to retain luggage laterally in the event of significant lurching of the vehicles and hence it may end up falling on passengers, as was the case in this incident.

## Factors associated with the post-incident response

### Ensuring that the train was safe to continue

#### **185 Lumo's incident response plan did not require actions that provided assurance that the train was in a safe condition to continue its journey.**

- 186 Before continuing the journey from Peterborough, the driver and the driver travelling as a passenger checked the train for visual defects (paragraph 80). This check was carried out from the platform.

<sup>21</sup> RSSB Project T1057 – Managing the risks posed by luggage to passengers and staff on trains and in stations.





Figure 22: Internal CCTV images showing luggage overhanging edges of overhead racks.

187 Any visual checks, especially conducted on only one side of the train from the platform, were of limited value in assessing whether the train was safe to continue its journey. These checks did not include an under-train examination to assess the condition of equipment mounted there or the condition of the wheels. Once the unit completed its journey, the train underwent an examination which included the condition of the wheels; no relevant faults were found.

188 While Lumo had procedures in place to manage the actions required following incidents such as collision or derailment, there was no procedure in place to manage the actions required following an overspeed incident.

### Occurrences of a similar character

189 RAIB investigated a derailment at Bletchley Junction which occurred on 3 February 2012 ([RAIB report 24/2012](#)). This accident was a result of overspeeding, because the train driver did not immediately observe and register what was being displayed by a signal's route indicator. The locomotive travelled over the junction, which had a maximum speed limit of 15 mph (24 km/h), at 65 mph (105 km/h), resulting in it derailing. RAIB concluded that the driver's belief that they were continuing straight ahead overcame the fact that the signal, indicating a diverging route, was clearly visible to them.

- 190 The report made a recommendation to the train operator to review its route knowledge training and assessment process to control the risk from drivers exceeding permissible speeds at diverging junctions. The recommendation asked the operator to consider the need to reinforce the knowledge by driving over the routes concerned, cab simulation, video-based scenario training, or other suitable techniques, and the required frequency of each. The recommendation also stated that this may apply to other train operators.
- 191 The report also made a recommendation to Network Rail in conjunction with train operators to assess the risk from overspeeding at junctions taking consideration of where the speed of the diverging route is significantly lower than the approach speed, the type of traction and its acceleration capability, and where fitted with standard alphanumeric route indicators.<sup>22</sup>
- 192 ORR responded to RAIB regarding this recommendation. ORR initially stated that Network Rail had carried out a detailed assessment for the southern end of the West Coast Main Line and had concluded that the results did not justify repeating this approach for the whole network. Follow-up by ORR led to Network Rail concluding that there were no reasonably practicable solutions at locations with similar characteristics to Bletchley. Further questioning by ORR led to Network Rail undertaking a peer-review workshop. Subsequently, all junction signals have been subject to detailed assessments using its signal overrun assessment toolset (SORAT). Bletchley Junction has since been remodelled and in February 2020 ORR reported that Network Rail had taken the recommendation into consideration and taken action to implement it.
- 193 RAIB investigated an overspeed incident at Fletton Junction near Peterborough on 11 September 2015 ([RAIB report 14/2016](#)). This caused the passenger carriages to lurch sideways resulting in minor injuries to three members of staff and one passenger. The train travelled over the junctions at 51 mph (82 km/h) and the track layout had a permitted speed of 25 mph (40 km/h).
- 194 The investigation concluded that it was likely that the train driver had forgotten about the presence of the speed restriction because they were distracted and fatigued due to issues related to their family. The investigation found that lineside signs and in-cab warnings may have contributed to them not responding appropriately as they approached the speed restriction. There were also no engineered controls to prevent the overspeeding. RAIB made a recommendation to both Network Rail and the train operator to identify locations where there is a greater than usual risk that a driver may be unaware of a speed restriction.
- 195 At around 13:00 hrs on 4 May 2023, another overspeeding incident occurred at Spital Junction. This involved the 09:54 hrs Sunderland to King's Cross service, operated by Grand Central.

---

<sup>22</sup> An indicator that displays instructions to drivers using letters and/or numbers.

- 196 The train involved, which was travelling in the same direction and on the same line as that involved in the April 2022 incident, passed over the three sets of points at a speed of around 65 mph (104 km/h). The excessive speed over the points led to the train lurching sideways and caused minor injuries to at least one person. The train did not derail during the incident and subsequently came to a stand at Peterborough station under emergency braking. Inspections carried out following the incident found that no damage had been caused to the railway infrastructure, or to the vehicles involved.
- 197 On 25 May 2023, RAIB issued urgent safety advice to Network Rail and transport undertakings who operate trains on the East Coast Main Line through Peterborough station (appendix C). This advised duty holders to take immediate steps, either operationally, or by technical means, to mitigate the risk of overspeeding beyond P468 signal at Spital Junction.
- 198 Network Rail has advised RAIB that since the issuing of the urgent safety advice following this second overspeeding incident, it has:
- a. issued an incident notice to train operators using this route (appendix D)
  - b. reviewed the arrangements for preventing and mitigating these overspeeding events, considering possible options; it is planned that these will be considered in due course
  - c. applied a temporary approach control change to restrict P468 signal to only display a single yellow aspect when a route is set which requires the junction indicator to be illuminated.
- 199 Grand Central has advised RAIB that since the issuing of the urgent safety advice on 25 May 2023 following the second overspeeding incident at Spital Junction on 4 May 2023, it has:
- a. issued a safety operational notice to its drivers to highlight the importance of actively looking for all parts of a signal
  - b. discussed with drivers the factors which contributed to both overspeeding incidents.
- 200 RAIB has announced its intention to investigate this more recent incident.

## Summary of conclusions

### Immediate cause

201 Train 1Y80 passed over a junction at excessive speed because the driver had controlled the speed appropriately for the through route rather than the slower, diverging route (paragraph 85).

### Causal factors

202 The causal factors were:

- a. The driver did not react appropriately to the junction indicator at P468 signal (paragraph 87, **Learning point 1**).
- b. The driver's awareness of the signal conditions that could be presented at this junction was not sufficient to override their expectation that the train was to be routed on the Up Fast line (paragraph 97). This happened probably because:
  - i. The driver's training did not provide them with sufficient understanding of the conditions that could be expected at this signal (paragraph 111, **Recommendation 1**).
- c. The signalling layout and configuration at this location did not, and nor was it required to, prevent the train from accelerating towards the diverging route and reaching an excessive speed from the distance at which a proceed aspect was given (paragraph 139, **Recommendations 2 and 3**).

### Underlying factors

203 The underlying factors were:

- a. Lumo had not assessed the risk associated with trains being unexpectedly routed on a slower, diverging route at this location and hence had not adequately mitigated the risk (paragraph 155, **Recommendation 1**).
- b. Network Rail does not control the risk of overspeeding at locations where there is a long distance between the approach controlled protecting signal and the junction itself, once a proceed aspect has been given to drivers (paragraph 164, **Recommendations 2 and 3**).

### Factors affecting the severity of consequences

204 Half of the injuries to passengers originated from the luggage stowed in the overhead luggage racks falling on them (paragraph 177, **Recommendation 4**).

### Factors associated with the post-incident response

205 Lumo's incident response plan did not require actions that provided assurance that the train was in a safe condition to continue its journey (paragraph 185, **Learning point 2**).



## Actions reported as already taken or in progress relevant to this report

206 Lumo has advised RAIB that since the incident it has:

- a. retrained and reassessed the driver, who is now back on duty
- b. enhanced its route learning briefing document having identified and ranked other similar locations which it considers its drivers should be aware of (paragraph 163)
- c. briefed all of its drivers on this incident and the specific risks that it highlighted
- d. reviewed what its driver instructors brief to drivers
- e. modified its post-incident procedures to include managing overspeed incidents
- f. progressed its revised luggage handling activities which include enhanced passenger information on its trains, removal of its on-board bike racking to allow luggage storage and fitting additional luggage stacks.

## Background to RAIB's recommendations

### European Train Control System

- 207 TPWS was adopted originally as an interim train protection measure (paragraph 170) until the implementation in the UK of the European Train Control System (ETCS), part of the European Rail Traffic Management System (ERTMS).
- 208 ETCS provides supervision of train movements, with an on-board computer continuously calculating the maximum permitted speed the train can travel at to allow it to brake safely before the end of its movement authority. It operates by communicating with trackside beacons (at lower ETCS levels) or a central communications hub (at higher ETCS levels) and informs train drivers of the speeds that their trains can travel at, with the permitted speed being displayed in the driver's cab. In the event a driver does not respond to the speed shown in the cab, the system will automatically control the train's speed. Within higher levels of ETCS, lineside signals can be removed so that there are none for the driver to observe.
- 209 The 2001 Uff/Cullen inquiry into train protection systems<sup>23</sup> recommended that this system should be operational on UK high speed lines by 2010. Although a level 2 ETCS system<sup>24</sup> became operational on the Cambrian line in 2011 and was fully commissioned in March 2011 and a level 2 ETCS system became operational on the Heathrow branch of the Elizabeth line in 2020, it has otherwise taken a significant time to develop and implement these systems across the rest of the mainline rail network in Great Britain. Older automatic train protection systems introduced by British Rail in the 1980s have also in some cases become obsolescent during this period and are being gradually withdrawn from service and replaced with later versions of TPWS<sup>25</sup> with exemptions from the regulations being granted by ORR.
- 210 In RAIB's report into the overspeed incident at Fletton Junction near Peterborough published in August 2016 (paragraph 193), Network Rail reported that ETCS was due to be commissioned on lines between King's Cross and Peterborough in 2022. RAIB has since been informed that its first use on the East Coast Main Line will be between London and Peterborough and will not become operational until 2029.
- 211 In consideration of these timescales, and the existing limited application of ETCS to the mainline rail network in Great Britain, recommendation 2 has been made with the intention of reducing the risk of overspeeding incidents at certain junctions in the interim period before ETCS is implemented.

<sup>23</sup> 'The joint inquiry into train protection systems', Professor John Uff QC FREng and The Rt Hon Lord Cullen PC, HSE, 2001. Available at <https://www.railwaysarchive.co.uk/docsummary.php?docID=192>.

<sup>24</sup> ETCS level 2 involves continuous supervision of train movement with constant communication via GSM-R radio between the train and trackside. ETCS level 2 does not require lineside signals, although some trackside signs are needed.

<sup>25</sup> Such as on Network Rail's Chiltern lines.

## Recommendations and learning points

### Recommendations

212 The following recommendations are made:<sup>26</sup>

- 1 *The intent of this recommendation is to reduce the risk of Lumo drivers overspeeding at diverging junctions where there is a significant reduction in maximum permitted speeds.*

Lumo (East Coast Trains Limited) should review, and amend as necessary, its route risk assessment process to ensure that it considers junctions where there is a potential for a greater risk of overspeeding (such as where there is a large distance between the point where a driver is given a clear aspect and the junction and/or where there is a large speed differential between the main and diverging routes).

Based on this revised risk assessment, Lumo should review the control measures in place intended to ensure that the risk from drivers exceeding permissible speeds at diverging junctions is adequately mitigated. This review should include consideration of the professional knowledge, training and assessment of its train drivers. Lumo should implement any changes necessary to mitigate the risk of overspeeding at junctions (paragraph 202b.i, 203a).

This recommendation may also apply to other train operators.

- 2 *The intent of this recommendation is for Network Rail to work with operators of trains to assess the risks of trains overspeeding at junctions fitted with approach controls.*

Network Rail should:

- a) Identify junctions fitted with approach controls where the risk from overspeeding could lead to derailment, injuries or damage (paragraphs 202c and 203b).

<sup>26</sup> Those identified in the recommendations have a general and ongoing obligation to comply with health and safety legislation, and need to take these recommendations into account in ensuring the safety of their employees and others.

Additionally, for the purposes of regulation 12(1) of the Railways (Accident Investigation and Reporting) Regulations 2005, these recommendations are addressed to the Office of Rail and Road to enable it to carry out its duties under regulation 12(2) to:

- (a) ensure that recommendations are duly considered and where appropriate acted upon; and
- (b) report back to RAIB details of any implementation measures, or the reasons why no implementation measures are being taken.

Copies of both the regulations and the accompanying guidance notes (paragraphs 200 to 203) can be found on RAIB's website [www.gov.uk/raib](http://www.gov.uk/raib).

- b) Share this information with the operators of trains which use the identified junctions to facilitate a collective re-assessment of the risk of trains overspeeding at those junctions. This assessment should consider, among other factors, the acceleration capability of the rolling stock using the junctions, the degree of overspeed and the potential consequences.

3 *The intent of this recommendation is to reduce the risk of trains overspeeding at junctions by considering appropriate mitigation measures.*

Based on the findings of the assessments undertaken as part of Recommendation 2 (paragraphs 202c and 203b), Network Rail, in conjunction with train operators, should jointly consider and implement risk mitigation measures at the junctions identified where the risk from overspeeding could lead to derailment, overturning or damage. Such risk mitigation measures could include:

- a) technical means (such as additional protection by signalling configuration changes) and/or the use of new technology (such as in-cab information systems to better inform drivers)
- b) operational considerations (such as reinforcing driver awareness, changes to service patterns and/or how signallers regulate trains at these junctions).

4 *The intent of this recommendation is to minimise the risks from falling luggage on Lumo train services.*

Lumo should assess the risks of high volumes of large and likely heavy luggage stowed in overhead luggage racks which can fall on passengers if trains suffer significant lateral accelerations. This assessment should specifically examine the design of overhead luggage racks, the amount of alternative luggage storage space provided and passenger luggage policies. Lumo should implement any control measures identified as appropriate (paragraph 204).

This recommendation may also apply to other train operators.

## Learning points

213 RAIB has identified the following important learning points:<sup>27</sup>

- 1 Drivers should be aware of the need to maintain alertness approaching junction signals so all the information the signal provides is acted upon. Drivers should not make assumptions about the route set ahead based on commonly set routes and their previous experience.
- 2 Train operating companies should have emergency plans which specifically include processes to deal with the aftermath of overspeeding incidents, such as that examined in this report. These emergency plans should consider the care of passengers and train crew and appropriate examination of the train involved to establish if it is fit to continue in service.

---

<sup>27</sup> 'Learning points' are intended to disseminate safety learning that is not covered by a recommendation. They are included in a report when RAIB wishes to reinforce the importance of compliance with existing safety arrangements (where RAIB has not identified management issues that justify a recommendation) and the consequences of failing to do so. They also record good practice and actions already taken by industry bodies that may have a wider application.

## Appendices

### Appendix A - Glossary of abbreviations and acronyms

AWS	Automatic warning system
CCTV	Closed-circuit television
ETCS	European Train Control System
GWR	Great Western Railway
HSE	Health and Safety Executive
HST	High Speed Train
JI	Junction indicator
LNER	London North Eastern Railway
ORR	Office of Rail and Road
OSS	Overspeed sensor system
OTDR	On-train data recorder
PSWI	Permissible speed warning indicator
RAIB	Rail Accident Investigation Branch
RSSB	Rail Safety and Standards Board
SPAD	Signal passed at danger
TPWS	Train Protection and Warning System
TSS	Train stop system

## Appendix B - Investigation details

RAIB used the following sources of evidence in this investigation:

- information provided by witnesses
- information taken from the train's OTDR
- CCTV recordings taken from the train and the station
- site photographs and measurements
- voice communication records
- weather reports and observations at the site
- information from Network Rail's signalling data records
- documents and records provided by Lumo and Network Rail
- information from the British Transport Police
- a vehicle dynamics report commissioned by RAIB
- a check for any previous reported overspeeding incidents at P468 signal
- a review of previous RAIB investigations that had relevance to this incident.



# Urgent Safety Advice 02/2023: Overspeeding through Spital Junction

Published 25 May 2023

## 1. Safety issue

Suitable arrangements may not be in place to mitigate the risk of trains travelling southbound through Spital Junction at excessive speeds when signalled from the Up Fast line onto the Up Slow lines at Peterborough station.

P468 signal, which controls this junction, is located 700 metres on the approach to the point of divergence. The signal is fitted with a position light junction indicator informing drivers of their signalled route. Under certain circumstances, the signal clears from red as a train approaches when a diverging route is set. The maximum permitted speed through the diverging junction is initially 30 mph (48 km/h), before reducing further to 25 mph (40 km/h).

Drivers who rarely experience being routed towards the slow lines when approaching Peterborough station from the north, and whose trains are not scheduled to stop at the station, may develop an expectation that their train will remain on the Up Fast line and miss some of the information provided at P468 signal when their train is being signalled onto the diverging route.

In these circumstances the distance from which a proceed aspect on P468 signal can be seen by approaching trains, and the distance from the signal to the junction, is sufficient to result in some trains being able to accelerate to speeds which could lead to derailment by overturning when passing through the junction.

## 2. Safety advice

Duty holders should take immediate steps, either operationally, or by technical means, to mitigate this risk.

## 3. Issued to:

Network Rail and transport undertakings who operate trains on the East Coast Main Line through Peterborough station.

## 4. Background

On 17 April 2022, the driver of a Lumo service from Newcastle to London King's Cross did not observe and react to the junction indicator on P468 signal which showed that the train was being signalled towards the slow lines at Spital Junction. Believing that his train was going to stay on the Up Fast line, he accelerated the train towards the junction and passed over it at 76 mph (122 km/h) instead of the 30 mph (48 km/h) maximum permitted speed.

On 4 May 2023, the driver of a Grand Central service from Sunderland to London King's Cross did not observe and react to the junction indicator on P468 signal which showed that the train was being signalled towards the slow lines at Spital Junction. Believing that his train was to stay on the Up Fast line, he accelerated his train towards the junction and passed over it at 65 mph (105 km/h).

## Appendix D - Network Rail incident notice

# Incident Notice

04/05/23

## P468 to Peterborough Platform 1

On 4<sup>th</sup> May 2023 an incident occurred in which a train travelled over the route from the Up Fast East Coast Main Line P468 signal to Peterborough platform 1 at approximately 60mph. The permitted speed for this route is 25mph.

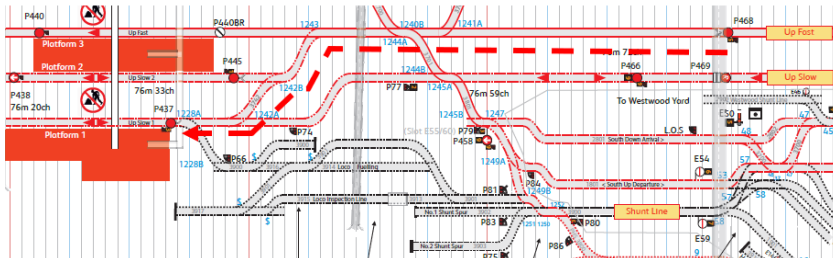
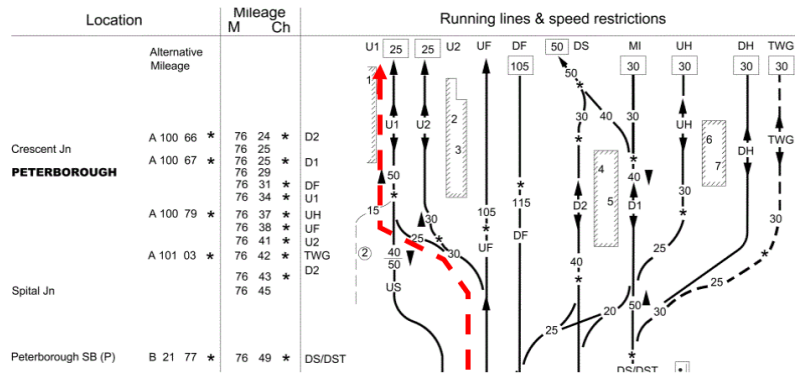

A similar incident occurred on 17/04/22 in which a train passed over the route at approximately 75 mph. This incident is currently being investigated by the Rail Accident Investigation Board.

Please ensure the Permanent Speed Restriction at these points is included in your Route Risk Assessments and is covered in driver training material and assessments.



This page is intentionally left blank

---

This report is published by the Rail Accident Investigation Branch,  
Department for Transport.

© Crown copyright 2023

Any enquiries about this publication should be sent to:

RAIB	Email: <a href="mailto:enquiries@raib.gov.uk">enquiries@raib.gov.uk</a>
The Wharf	Telephone: 01332 253300
Stores Road	Website: <a href="http://www.raib.gov.uk">www.raib.gov.uk</a>
Derby UK	
DE21 4BA	