



INSTRUCTIONS FOR THE GUIDANCE OF SURVEYORS ON
INTACT STABILITY
IMO 2008 IS CODE
& Explanatory Notes

MSIS43

Rev 05.23

Applicable to the following ship types: -
Cargo ships
Cargo ships with timber deck cargoes
Passenger ships
Fishing vessels
Special purpose ships
Offshore supply vessels
MODUs
Pontoons
Cargo ships carrying containers on deck
Container ships

having length \geq 24 m
and
keels laid on or after 5th December 2008



AMENDMENTS

Version Number	Status Change	Date	Author Reviewer	Content Approver	Next Review Date/Expiry Date
Issue 1 R05.20	New Document	14/5/2020	Andrew Scott Policy Lead, Stability, Load line & Tonnage	Pete Rollason Ship Safety Lead	14/05/2025
Issue 2 R05.23	Updated Document	06/04/2023	Andrew Scott Policy Lead, Stability, Load line & Tonnage	Pete Rollason Ship Safety Lead	06/04/2028

Introduction

INTACT STABILITY 2008 IS CODE

This publication includes the full text of the IMO 2008 Intact Stability (IS) Code¹ which entered into force for applicable ships with keels laid on or after December 5, 2008² and the associated Explanatory Notes³.

In Issue 1 the original text of the Code was updated to show various subsequent amendments introduced by Resolutions MSC.319(89), MSC.389(95), MSC.413(97) and MSC.415(97). Issue 2 now includes amendments introduced by MSC.1/Circ.1537 and the corrigenda included in MSC 85/Add.1/Corr.3/Rev.1. These text amendments are highlighted, and notes indicate their various dates of entry into force as appropriate. The omission of the term (f/B) in the formula for M_L in Part B paragraph 2.9.1.2 of Issue 1 has now been corrected.

MCA Guidance Notes or additions/explanations to the original text are shown in blue font as appropriate. The main chapter headings are hyper-linked in the contents for ease of reference.

The mandatory regulations in the Introduction and Part A are shown in black Ariel 12 font and the recommended provisions in Part B are shown in black Ariel 10 font. The Explanatory Notes are shown in red Ariel 10 font after the Code itself.

Current intact stability related UK SI's and guidance remain applicable to all vessels constructed before 5/12/2008 and any such vessels which undergo major conversion after 5/12/2008.

¹ See Resolution MSC.267(85), adopted on 4th December 2008.

² See MSC.1/Circ.1292 "Early application of the international code on intact stability, 2008" concerning the date of entry into force encouraging member states to apply the Code from 5th December 2008.

³ See MSC.1/Circ.1281 "Explanatory Notes to the International Code on Intact Stability, 2008.

Guidance on International Code on Intact Stability 2008 (2008 IS Code)

Contents

Preamble

Introduction

- 1 [Purpose](#)
- 2 [Definitions](#)

Part A - Mandatory criteria

Chapter 1 - General

- 1.1 [Application](#)
- 1.2 [Dynamic stability phenomena in waves](#)

Chapter 2 - General criteria

- 2.1 [General](#)
- 2.2 [Criteria regarding righting lever curve properties](#)
- 2.3 [Severe wind and rolling criterion \(weather criterion\)](#)

Chapter 3 - Special criteria for certain types of ships

- 3.1 [Passenger ships](#)
- 3.2 [Oil tankers of 5,000 dwt and above](#)
- 3.3 [Cargo ships carrying timber deck cargoes](#)
- 3.4 [Cargo ships carrying grain in bulk](#)
- 3.5 [High-speed craft](#)

Part B - Recommendations for certain types of ships and additional guidelines

Chapter 1 - General

- 1.1 [Purpose](#)
- 1.2 [Application](#)

Chapter 2 - Recommended design criteria for ships engaged in certain types of operation and certain types of ships

- 2.1 [Fishing vessels](#)
- 2.2 [Pontoons](#)
- 2.3 [Containerships greater than 100 m](#)
- 2.4 [Offshore supply vessels](#)
- 2.5 [Special purpose ships](#)
- 2.6 [Mobile offshore drilling units \(MODUs\)](#)
- 2.7 [Ships engaged in anchor handling operations](#)
- 2.8 [Ships engaged in towing and escort operations](#)
- 2.9 [Ships engaged in lifting operations](#)

Note: the amendments highlighted are from MSC.415(97) and enter into force 1 January 2020

Chapter 3 - Guidance in preparing stability information

- 3.1 [Effect of free surfaces of liquids in tanks](#)
- 3.2 [Permanent ballast](#)
- 3.3 [Assessment of compliance with stability criteria](#)
- 3.4 [Standard conditions of loading to be examined](#)
- 3.5 [Calculation of stability curves](#)
- 3.6 [Stability booklet](#)
- 3.7 [Operational measures for ships carrying timber deck cargoes](#)
- 3.8 [Operating booklets for certain ships](#)

Chapter 4 - Stability calculations performed by stability instruments

- 4.1 [Stability instruments](#)

Chapter 5 - Operational provisions against capsizing

- 5.1 [General precautions against capsizing](#)
- 5.2 [Operational precautions in heavy weather](#)
- 5.3 [Ship handling in heavy weather](#)

Chapter 6 - Icing considerations

- 6.1 [General](#)
- 6.2 [Cargo ships carrying timber deck cargoes](#)
- 6.3 [Fishing vessels](#)
- 6.4 [Offshore supply vessels 24 m to 100 m in length](#)

Chapter 7 - Considerations for watertight and weathertight integrity

- 7.1 [Hatchways](#)
- 7.2 [Machinery space openings](#)
- 7.3 [Doors](#)
- 7.4 [Cargo ports and other similar openings](#)
- 7.5 [Sidescuttles, window scuppers, inlets and discharges](#)
- 7.6 [Other deck openings](#)
- 7.7 [Ventilators, air pipes and sounding devices](#)
- 7.8 [Freeing ports](#)
- 7.9 [Miscellaneous](#)

Chapter 8 - Determination of lightship parameters

- 8.1 [Application](#)
- 8.2 [Preparations for the inclining test](#)
- 8.3 [Plans required](#)
- 8.4 [Test procedure](#)
- 8.5 [Inclining test for MODUs](#)
- 8.6 [Stability test for pontoons](#)

Annex 1 - Detailed guidance for the conduct of an inclining test

- 1 [Introduction](#)
- 2 [Preparations for the inclining test](#)
- 2.1 [Free surface and tankage](#)
- 2.2 [Mooring arrangements](#)
- 2.3 [Test weights](#)
- 2.4 [Pendulums](#)
- 2.5 [U-tubes](#)
- 2.6 [Inclinometers](#)
- 3 [Equipment required](#)
- 4 [Test procedure](#)
- 4.1 [Initial walk through and survey](#)
- 4.2 [Freeboard/draught readings](#)
- 4.3 [The incline](#)

Annex 2 - Recommendations for skippers of fishing vessels on ensuring a vessel's endurance in conditions of ice formation

- 1 [Prior to departure](#)
- 2 [At sea](#)
- 3 [During ice formation](#)
- 4 [List of equipment and hand tools](#)

[Annex 3](#) – Recommended model for graphic or tabular presentation of permissible tensions for use in anchor handling operations

Preamble

1 This Code has been assembled to provide, in a single document, mandatory requirements in the introduction and in part A and recommended provisions in part B relating to intact stability, based primarily on existing IMO instruments. Where recommendations in this Code appear to differ from other IMO Codes, the other Codes should be taken as the prevailing instrument. For the sake of completeness and for the convenience of the user, this Code also contains relevant provisions from mandatory IMO instruments.

2 Criteria included in the Code are based on the best “state-of-the-art” concepts, available at the time they were developed, taking into account sound design and engineering principles and experience gained from operating ships. Furthermore, design technology for modern ships is rapidly evolving and the Code should not remain static but should be re-evaluated and revised, as necessary. To this end, the Organization will periodically review the Code taking into consideration both experience and further development.

3 A number of influences such as the dead ship condition, wind on ships with large windage area, rolling characteristics, severe seas, etc., were taken into account based on the state-of-the-art technology and knowledge at the time of the development of the Code.

4 It was recognized that in view of a wide variety of types, sizes of ships and their operating and environmental conditions, problems of safety against accidents related to stability have generally not yet been solved. In particular, the safety of a ship in a seaway involves complex hydrodynamic phenomena which up to now have not been fully investigated and understood. Motion of ships in a seaway should be treated as a dynamical system and relationships between ship and environmental conditions like wave and wind excitations are recognized as extremely important elements. Based on hydrodynamic aspects and stability analysis of a ship in a seaway, stability criteria development poses complex problems that require further research.

Introduction

1 Purpose

1.1 The purpose of the Code is to present mandatory and recommendatory stability criteria and other measures for ensuring the safe operation of ships, to minimize the risk to such ships, to the personnel on board and to the environment. This introduction and part A of the Code address the mandatory criteria and part B contains recommendations and additional guidelines.

1.2 Unless otherwise stated, this Code contains intact stability criteria applicable to ~~ships for the following types of~~ ships and other marine vehicles of 24 m in length and above, ~~unless otherwise stated as listed below~~. The Code also provides intact stability criteria applicable to the same ships and marine vehicles when engaged in certain operations:

- .1 cargo ships;
- .2 cargo ships carrying timber deck cargoes;
- .3 passenger ships;
- .4 fishing vessels;
- .5 special purpose ships;
- .6 offshore supply vessels;
- .7 ships engaged in anchor handling operations;
- .8 ships engaged in harbor, coastal or ocean-going towing operations and escort operations;
- .9 ships engaged in lifting operations;
- .10 mobile offshore drilling units;
- .11 pontoons; and
- .12 cargo ships carrying containers on deck and containerships.

1.3 The MCA may impose additional requirements regarding the design aspects of ships of novel design or ships not otherwise covered by the Code.

Note: the amendments highlighted are from MSC.413(97) and enter into force 1st January 2020

2 Definitions

For the purpose of this Code the definitions given hereunder shall apply. For terms used, but not defined in this Code, the definitions as given in the 1974 SOLAS Convention as amended shall apply.

2.1 *Administration* means the Government of the State whose flag the ship is entitled to fly.

2.2 *Passenger ship* is a ship which carries more than twelve passengers as defined in regulation I/2 of the 1974 SOLAS Convention, as amended.

2.3 *Cargo ship* is any ship which is not a passenger ship, a ship of war and troopship, a ship which is not propelled by mechanical means, a wooden ship of primitive build, a fishing vessel and a mobile offshore drilling unit.

2.4 *Oil tanker* means a ship constructed or adapted primarily to carry oil in bulk in its cargo spaces and includes combination carriers and any chemical tanker as defined in Annex II of the MARPOL Convention when it is carrying a cargo or part cargo of oil in bulk.

2.4.1 *Combination carrier* means a ship designed to carry either oil or solid cargoes in bulk.

2.4.2 *Crude oil tanker* means an oil tanker engaged in the trade of carrying crude oil.

2.4.3 *Product carrier* means an oil tanker engaged in the trade of carrying oil other than crude oil.

2.5 *Fishing vessel* is a vessel used for catching fish, whales, seals, walrus or other living resources of the sea.

2.6 *Special purpose ship* has the same definition as in the Code of Safety for Special Purpose Ships, 2008 (resolution MSC.266(84)).

2.7 *Offshore supply vessel* means a vessel which is engaged primarily in the transport of stores, materials and equipment to offshore installations and designed with accommodation and bridge erections in the forward part of the vessel and an exposed cargo deck in the after part for the handling of cargo at sea.

2.8 *Mobile offshore drilling unit* (MODU or unit) is a ship capable of engaging in drilling operations for the exploration or exploitation of resources beneath the seabed such as liquid or gaseous hydrocarbons, sulphur or salt.

2.8.1 *Column-stabilized unit* is a unit with the main deck connected to the underwater hull or footings by columns or caissons.

2.8.2 *Surface unit* is a unit with a ship- or barge-type displacement hull of single or multiple hull construction intended for operation in the floating condition.

2.8.3 *Self-elevating unit* is a unit with moveable legs capable of raising its hull above the surface of the sea.

2.8.4 *Coastal State* means the Government of the State exercising administrative control over the drilling operations of the unit.

2.8.5 *Mode of operation* means a condition or manner in which a unit may operate or function while on location or in transit. The modes of operation of a unit include the following:

.1 *operating conditions* means conditions wherein a unit is on location for the purpose of conducting drilling operations, and combined environmental and operational loadings are within the appropriate design limits established for such operations. The unit may be either afloat or supported on the sea-bed, as applicable;

.2 *severe storm conditions* mean conditions wherein a unit may be subjected to the most severe environmental loadings for which the unit is designed. Drilling operations are assumed to have been discontinued due to the severity of the environmental loadings, the unit may be either afloat or supported on the sea-bed, as applicable; and

.3 *transit conditions* mean conditions wherein a unit is moving from one geographical location to another.

2.9 *High-speed craft (HSC)*¹ is a craft capable of a maximum speed, in metres per second (m/s), equal to or exceeding:

$$3.7 * \nabla^{0.1667}$$

where: ∇ = displacement corresponding to the design waterline (m³).

¹ The Code of Safety for High-Speed Craft, 2000 (2000 HSC Code) has been developed following a thorough revision of the Code of Safety for High-Speed Craft, 1994 (1994 HSC Code) which was derived from the previous Code of Safety for Dynamically Supported Craft (DSC Code) adopted by IMO in 1977, recognizing that safety levels can be significantly enhanced by the infrastructure associated with regular service on a particular route, whereas the conventional ship safety philosophy relies on the ship being self-sustaining with all necessary emergency equipment being carried on board.

2.10 *Containership* means a ship which is used primarily for the transport of marine containers.

2.11 *Freeboard* is the distance between the assigned load line and freeboard deck. For the purposes of application of chapters I and II of Annex I of the International Convention on Load Lines, 1966 or the Protocol of 1988 as amended, as applicable to open-top containerships, “freeboard deck” is the freeboard deck according to the International Convention on Load Lines, 1966 or the Protocol of 1988 as amended, as applicable as if hatch covers are fitted on top of the hatch cargo coamings

2.12 *Length of ship*. The length should be taken as 96% of the total length on a waterline at 85% of the least moulded depth measured from the top of the keel, or as the length from the fore side of the stem to the axis of the rudder stock on the waterline, if that be greater. In ships designed with a rake of keel the waterline on which this length is measured should be parallel to the designed waterline.

2.13 *Moulded breadth* is the maximum breadth of the ship measured amidships to the moulded line of the frame in a ship with a metal shell and to the outer surface of the hull in a ship with a shell of any other material.

2.14 *Moulded depth* is the vertical distance measured from the top of the keel to the top of the freeboard deck beam at side. In wood and composite ships, the distance is measured from the lower edge of the keel rabbet. Where the form at the lower part of the midship section is of a hollow character, or where thick garboards are fitted, the distance is measured from the point where the line of the flat of the bottom continued inwards cuts the side of the keel. In ships having rounded gunwales, the moulded depth should be measured to the point of intersection of the moulded lines of the deck and side shell plating, the lines extending as though the gunwale were of angular design. Where the freeboard deck is stepped and the raised part of the deck extends over the point at which the moulded depth is to be determined, the moulded depth should be measured to a line of reference extending from the lower part of the deck along a line parallel with the raised part.

2.15 *Near-coastal voyage* means a voyage in the vicinity of the coast of a State as defined by the Administration of that State.

2.16 *Pontoon* is considered to be normally:

- .1 non self-propelled;
- .2 unmanned;

Note: the amendment to 2.11 is from MSC 85/26/Add.1/Corr.3/Rev. 1 dated 9 October 2018 and was formerly a footnote. See MSC 99/22 paragraph 10.23 for the reasons for the change.

- .3 carrying only deck cargo;
- .4 having a block coefficient of 0.9 or greater;

- .5 having a breadth/depth ratio of greater than 3; and
- .6 having no hatchways in the deck except small manholes closed with gasketed covers.

2.17 *Timber* means sawn wood or lumber, cants, logs, poles, pulpwood and all other types of timber in loose or packaged forms. The term does not include wood pulp or similar cargo.

2.18 *Timber deck cargo* means a cargo of timber carried on an uncovered part of a freeboard or superstructure deck. The term does not include wood pulp or similar cargo.³

2.19 *Timber load line* means a special load line assigned to ships complying with certain conditions related to their construction set out in the International Convention on Load Lines and used when the cargo complies with the stowage and securing conditions of the Code of Safe Practice for Ships Carrying Timber Deck Cargoes, 1991 (resolution A.715(17)).

2.20 *Certification of the inclining test weights* is the verification of the weight marked on a test weight. Test weights should be certified using a certificated scale. The weighing should be performed close enough in time to the inclining test to ensure the measured weight is accurate.

2.21 *Draught* is the vertical distance from the moulded baseline to the waterline

2.22 The *inclining test* involves moving a series of known weights, normally in the transverse direction, and then measuring the resulting change in the equilibrium heel angle of the ship. By using this information and applying basic naval architecture principles, the ship's vertical centre of gravity (VCG) is determined.

2.23 *Lightship condition* is a ship complete in all respects, but without consumables, stores, cargo, crew and effects, and without any liquids on board except that machinery and piping fluids, such as lubricants and hydraulics, are at operating levels.

The MCA accepts the following unified interpretation of the definition of "lightship" as shown in MSC.1/Circ. 1537/Rev.1 dated 4 July 2019: -

The weight of mediums on board for the fixed firefighting systems (e.g. freshwater, CO₂, dry chemical powder, foam concentrate, etc.) should be included in the lightweight and lightship condition.

³ Refer to regulation 42(1) of the International Convention on Load Lines, 1966 or the Protocol of 1988 as amended, as applicable.

2.24 A *lightweight survey* involves taking an audit of all items which should be added, deducted or relocated on the ship at the time of the inclining test so that the observed condition of the ship can be adjusted to the lightship condition. The mass, longitudinal, transverse and vertical location of each item should be accurately determined and recorded. Using this information, the static waterline of the ship at the time of the inclining test as determined from measuring the freeboard or verified draught marks of the ship, the ship's hydrostatic data, and the sea water density, the lightship displacement and longitudinal centre of gravity (LCG) can be obtained. The transverse centre of gravity (TCG) may also be determined for mobile offshore drilling units (MODUs) and other ships which are asymmetrical about the centreline or whose internal arrangement or outfitting is such that an inherent list may develop from off-centre mass.

2.25 An *in-service inclining test* means an inclining test which is performed in order to verify the pre-calculated *GMC* and the deadweight's centre of gravity of an actual loading condition.

2.26 A *Stability Instrument* is an instrument installed on board a particular ship by means of which it can be ascertained that stability requirements specified for the ship in Stability Booklet are met in any operational loading condition. A Stability Instrument comprises hardware and software.

2.27 *Ship engaged in anchor handling operations* means a ship engaged in operations with deployment, recovering and repositioning of anchors and the associated mooring lines of rigs or other vessels. Forces associated with anchor handling are generally associated with the winch line pull and may include vertical, transverse, and longitudinal forces applied at the towing point and over the stern roller.

2.28 *Ship engaged in harbour towing* means a ship engaged in an operation intended for assisting ships or other floating structures within sheltered waters, normally while entering or leaving port and during berthing or unberthing operations.

2.29 *Ship engaged in coastal or ocean-going towing* means a ship engaged in an operation intended for assisting ships or other floating structures outside sheltered waters in which the forces associated with towing are often a function of the ship's bollard pull.⁴

⁴ Refer to the Guidelines for safe ocean towing (MSC/Circ.884).

2.30 *Ship engaged in lifting operation* means a ship engaged in an operation involving the raising or lowering of objects using vertical force by means of winches, cranes, A-frames or other lifting devices. Fishing vessels shall not be included in this definition.⁵

2.31 *Ship engaged in escort operation* means a ship specifically engaged in steering, braking and otherwise controlling of the assisted ship during ordinary or emergency manoeuvring, whereby the steering and braking forces are generated by the hydrodynamic forces acting on the hull and appendages and the thrust forces exerted by the propulsion units (see also figure 1).

⁵ Fishing vessels should not be included in the definition of lifting operations. Reference is made to paragraphs 2.1.2.2 and 2.1.2.8 of chapter 2 of part B. For anchor handling operations reference is made to section 2.7 of chapter 2 of part B.

Note: the amendments highlighted are from MSC.413(97) and enter into force 1st January 2020

PART A

MANDATORY CRITERIA

Part A Chapter 1- General

1.1 Application

1.1.1 The criteria stated under chapter 2 of this part present a set of minimum requirements that shall apply to cargo and passenger ships of 24 m in length and over. For container ships of 100 m in length and over, criteria alternative to section 2.2 of this part may be applied.³ Offshore supply vessels and special purpose ships are not required to comply with the provisions of section 2.3. For such vessels, compliance with equivalent alternative criteria⁴ shall be demonstrated.

1.1.2 The criteria stated under chapter 3 are special criteria for certain types of ships. For the purpose of part A, the definitions given in the Introduction apply.

1.2 Dynamic stability phenomena in waves

Administrations shall be aware that some ships are more at risk of encountering critical stability situations in waves. Necessary precautionary provisions may need to be taken in the design to address the severity of such phenomena. The phenomena in seaways which may cause large roll angles and/or accelerations have been identified hereunder.

Having regard to the phenomena described in this section, the MCA may for a particular ship or group of ships apply criteria demonstrating that the safety of the ship is sufficient. Any Administration which applies such criteria should communicate to the Organization particulars thereof. It is recognized by the Organization that performance-oriented criteria for the identified phenomena listed in this section need to be developed and implemented to ensure a uniform international level of safety.

1.2.1 Righting lever variation

Any ship exhibiting large righting lever variations between wave trough and wave crest condition may experience parametric roll or pure loss of stability or combinations thereof.

Note: the amendments in 1.1.1 are from MSC 85/26/Add.1/Corr.3/Rev. 1 dated 9 October 2018

³ The provisions of section 2.3 of part B may be applied as an alternative.

⁴ For offshore supply vessels, the provisions of section 2.4 of part B may be applied as an alternative to the application of section 2.2 of this part. For special purpose ships, provisions of section 2.5 of part B may be applied as an alternative to the application of section 2.2 of this part.

1.2.2 Resonant roll in dead ship condition

Ships without propulsion or steering ability may be endangered by resonant roll while drifting freely.

1.2.3 *Broaching and other manoeuvring related phenomena*

Ships in following and quartering seas may not be able to keep constant course despite maximum steering efforts which may lead to extreme angles of heel.

Part A Chapter 2- General Criteria***2.1 General**

2.1.1 All criteria contained in this part shall be applied for all applicable conditions of loading.⁵ ~~as set out in part B, 3.3 and 3.4.~~

2.1.2 Free surface effects⁶ ~~(part B, 3.1)~~ shall be accounted for in all applicable conditions of loading.⁵ ~~as set out in part B, 3.3 and 3.4.~~

Note: the amendments in 2.1.1&2 are from MSC 85/26/Add.1/Corr.3/Rev.1 dated 9 October 2018

⁵ Refer to sections 3.3 and 3.4 of part B, for the conditions of loading to be considered.

⁶ Refer to section 3.1 of part B.

2.1.3 Where anti-rolling devices are installed in a ship, the MCA shall be satisfied that the criteria can be maintained when the devices are in operation and that failure of power supply or the failure of the device(s) will not result in the vessel being unable to meet the relevant provisions of this Code.

2.1.4 A number of influences such as icing of topsides, water trapped on deck, etc., adversely affect stability and the Administration is advised to take these into account, so far as is deemed necessary.

2.1.5 Provisions shall be made for a safe margin of stability at all stages of the voyage, regard being given to additions of weight, such as those due to absorption of water and icing.⁷ ~~(details regarding ice accretion are given in part B, chapter 6 – Icing considerations)~~ and to losses of weight such as those due to consumption of fuel and stores.

2.1.6 Each ship shall be provided with a stability booklet, approved by the MCA, which contains sufficient information⁸ ~~(see part B, 3.6)~~ to enable the master to operate the ship in compliance with the applicable requirements contained in the Code. If a stability instrument is used as a supplement to the stability booklet for the purpose of determining compliance with the relevant stability criteria such instrument shall be subject to the approval by the MCA.⁹ ~~(see part B, chapter 4 – Stability calculations performed by stability instruments).~~

Note: the amendments in 2.1.5&6 are from MSC 85/26/Add.1/Corr.3/Rev.1 dated 9 October 2018

⁷ Details regarding ice accretion are given in chapter 6 (icing considerations) of part B.

⁸ Refer to section 3.6 of part B.

⁹ Refer to chapter 4 (Stability calculations performed by stability instruments) of part B.

2.1.7 If curves or tables of minimum operational metacentric height (GM) or maximum centre of gravity (VCG) are used to ensure compliance with the relevant intact stability criteria those limiting curves shall extend over the full range of operational trims, unless the MCA agrees that trim effects are not significant.

When curves or tables of minimum operational metacentric height (GM) or maximum centre of gravity (VCG) versus draught covering the operational trims are not available, the master must verify that the operating condition does not deviate from a studied loading condition or verify by calculation that the stability criteria are satisfied for this loading condition taking into account trim effects.

~~*Paragraphs 3.4.1.8, 3.4.1.9, 3.6.4 and 3.6.5 in part B should only be considered as recommendations. Note that this footnote was later deleted (see Res. MSC.443 and 444 (99)).~~

2.2 Criteria regarding righting lever curve properties

2.2.1 The area under the righting lever curve (GZ curve) shall not be less than 0.055 metre-radians up to $\varphi = 30^\circ$ angle of heel and not less than 0.09 metre-radians up to $\varphi = 40^\circ$ or the angle of down-flooding φ_f if this angle is less than 40° . Additionally, the area under the righting lever curve (GZ curve) between the angles of heel of 30° and 40° or between 30° and φ_f , if this angle is less than 40° , shall not be less than 0.03 metre-radians. **The angle φ_f is an angle of heel at which openings in the hull, superstructures or deckhouses which cannot be closed weathertight immerse. Small openings through which progressive flooding cannot take place need not be considered as open.**

Note: the above amendments in 2.2.1 and removal of the footnote below are from MSC 85/26/Add.1/Corr.3/Rev.1 dated 9 October 2018

2.2.2 The righting lever GZ shall be at least 0.2 m at an angle of heel equal to or greater than 30° .

2.2.3 The maximum righting lever shall occur at an angle of heel not less than 25° . If this is not practicable, alternative criteria, based on an equivalent level of safety⁶, may be applied subject to the approval of the MCA.

2.2.4 The initial metacentric height GM_0 shall not be less than 0.15 m.

⁵ ~~φ_f is an angle of heel at which openings in the hull, superstructures or deckhouses which cannot be closed weathertight immerse. In applying this criterion, small openings through which progressive flooding cannot take place need not be considered as open.~~

⁶ Refer to the Explanatory Notes to the International Code on Intact Stability, 2008 (MSC.1/Circ.1281).

2.3 Severe wind and rolling criterion (weather criterion)

2.3.1 The ability of a ship to withstand the combined effects of beam wind and rolling shall be demonstrated, with reference to the figure 2.3.1 as follows:

- .1 the ship is subjected to a steady wind pressure acting perpendicular to the ship's centreline which results in a steady wind heeling lever (l_{w1});
- .2 from the resultant angle of equilibrium (φ_0), the ship is assumed to roll owing to wave action to an angle of roll (φ_1) to windward. The angle of heel under action of steady wind (φ_0) should not exceed 16° or 80% of the angle of deck edge immersion, whichever is less;
- .3 the ship is then subjected to a gust wind pressure which results in a gust wind heeling lever (l_{w2}); and
- .4 under these circumstances, area b shall be equal to or greater than area a , as indicated in figure 2.3.1 below:

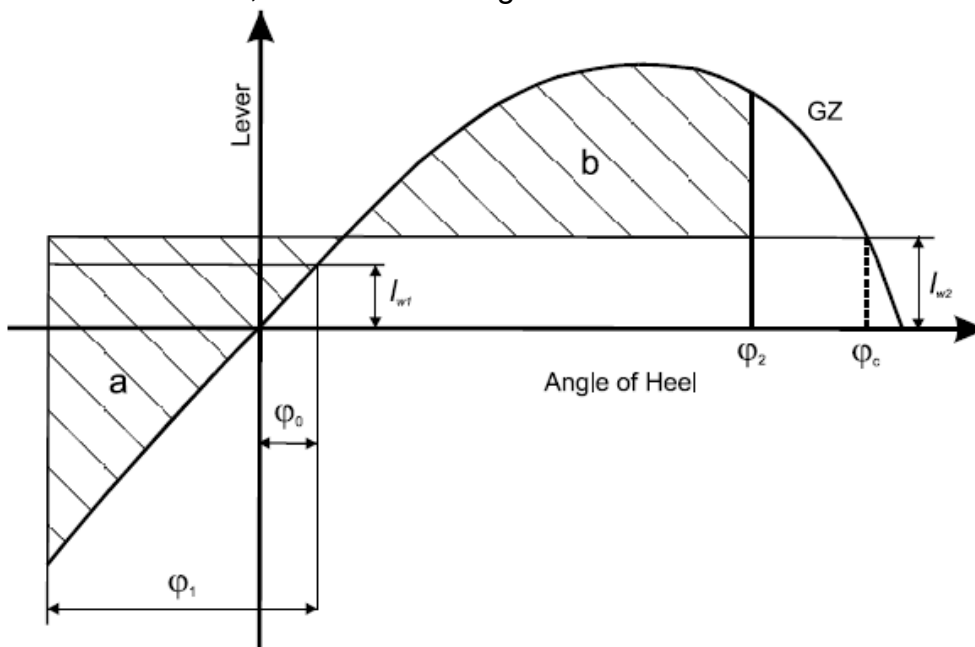

Figure 2.3.1 - Severe wind and rolling

where the angles in figure 2.3.1 are defined as follows:

φ_0 = angle of heel under action of steady wind

φ_1 = angle of roll to windward due to wave action (see 2.3.1.2, 2.3.4 and footnote 6)

φ_2 = angle of down-flooding (φ_f) or 50° or φ_c , whichever is less,

where:

φ_f = angle of heel at which openings in the hull, superstructures or deckhouses which cannot be closed weathertight immerse. In applying this criterion, small openings through which progressive flooding cannot take place need not be considered as open.

The MCA accepts the following unified interpretation of the definition of “ φ_f ” as shown in MSC.1/Circ. 1537/Rev.1 dated 4 July 2019: -

In applying φ_f , openings which cannot be or are incapable of being closed weathertight include ventilators (complying with regulation 19(4) of the International Convention on Load Lines, 1966) that for operational reasons have to remain open to supply air to the engine room, ~~or~~ emergency generator room or closed ro-ro and vehicle spaces (if the same is considered buoyant in the stability calculation or protecting openings leading below) for the effective operation of the ship. Where it is not technically feasible to treat some closed ro-ro and vehicle space ventilators as unprotected openings, The MCA may allow an alternative arrangement that provides an equivalent level of safety.

φ_c = angle of second intercept between wind heeling lever l_{w2} and GZ curves.

2.3.2 The wind heeling levers l_{w1} and l_{w2} referred to in 2.3.1.1 and 2.3.1.3 are constant values at all angles of inclination and shall be calculated as follows:

$$l_{w1} = \frac{P * A * Z}{1000 * g * \Delta} \quad (m) \quad \text{and}$$

$$l_{w2} = 1.5 * l_{w1} \quad (m)$$

where:

P = wind pressure of 504 Pa (**N/m²**). The value of P used for ships in restricted service may be reduced subject to the approval of the MCA (**e.g. 168 Pa (N/m²) in UK categorized waters. See Table 2.3.4-4.**)

A = projected lateral area of the portion of the ship and deck cargo above the waterline (m²);

Z = vertical distance from the centre of A to the centre of the underwater lateral area or approximately to a point at one half the mean draught (m);

Δ = displacement (t)

g = gravitational acceleration of 9.81 m/s²

2.3.3 Alternative means for determining the wind heeling lever (I_{w1}) may be accepted, to the satisfaction of the MCA, as an equivalent to calculation in 2.3.2. When such alternative tests are carried out, reference shall be made based on the Guidelines developed by the Organization⁷. The wind velocity used in the tests shall be 26 m/s in full scale with uniform velocity profile. The value of wind velocity used for ships in restricted services may be reduced to the satisfaction of the MCA (e.g. 15 m/s for vessels in UK categorized waters).

⁷ Refer to the Interim Guidelines for alternative assessment of the weather criterion (MSC.1/Circ.1200).

2.3.4 The angle of roll (φ_1)⁸ referred to in 2.3.1.2 shall be calculated as follows:

$$\varphi_1 = 109 * k * X_1 * X_2 * \sqrt{r * s} \quad (\text{degrees})$$

where:

X_1 = factor as shown in table 2.3.4-1

X_2 = factor as shown in table 2.3.4-2

k = factor as follows:

k = 1.0 for round-bilged ship having no bilge or bar keels

k = 0.7 for a ship having sharp bilges

“Sharp bilge” shall be considered a bilge radius <1% breadth (B) and an angle between piecewise lines representing the bilge smaller than 120 degrees

k = as shown in table 2.3.4-3 for a ship having bilge keels, a bar keel or both

r = $0.73 + 0.6 OG/d$ or **1.0 (whichever is less, an equivalence agreed by the EU on 22nd November 2007).**

with:

OG = $KG - d$

d = mean moulded draught of the ship (m)

s = factor as shown in table 2.3.4-4 where T is the ship roll natural period. In absence of sufficient information, the following approximate formula can be used:

Rolling period $T = \frac{2 * C * B}{\sqrt{GM}} (s)$

where:

$$C = 0.373 + 0.023(B/d) - 0.043(L_{wl}/100).$$

The angle of roll for ships with anti-rolling devices should be determined without taking into account the operation of these devices unless the **MCA** is satisfied with the proof that the devices are effective even with sudden shutdown of their supplied power.

Note: this amendment to 2.3.4 and removal of the old footnote ⁸ is from MSC 85/26/Add.1/Corr.3/Rev.1 dated 9 October 2018

The symbols in tables 2.3.4-1, 2.3.4-2, 2.3.4-3 and 2.3.4-4 and the formula for the rolling period are defined as follows:

L_{wl} = length of the ship at waterline (m)

B = moulded breadth of the ship (m)

d = mean moulded draught of the ship (m)

C_B = block coefficient

A_k = total overall area of bilge keels, or area of the lateral projection of the bar keel, or sum of these areas (m²); **may also include the centre skeg.**

GM = metacentric height corrected for free surface effect (m).

Table 2.3.4-1 – Values of factor X_1

B/d	X_1
≤ 2.4	1.0
2.5	0.98
2.6	0.96
2.7	0.95
2.8	0.93
2.9	0.91
3.0	0.90
3.1	0.88
3.2	0.86
3.4	0.82
3.5	0.80
3.6	0.79
4.0	0.78
4.5	0.76

5.0	0.72
5.5	0.68
6.0	0.64
6.5	0.62

Note:- B/d - X_1 values in Table 2.3.4-1 above have been extended to cover wide-beam shallow-draught vessels, an equivalence agreed to by the EU on 22nd November 2007.

Table 2.3.4-2 – Values of factor X_2

C_B	X_2
≤ 0.45	0.75
0.50	0.82
0.55	0.89
0.60	0.95
0.65	0.97
≥ 0.70	1.00

Table 2.3.4-3 – Values of factor k

$\frac{A_k \times 100}{L_{WL} \times B}$	k
0	1.0
1.0	0.98
1.5	0.95
2.0	0.88
2.5	0.79
3.0	0.74
3.5	0.72
≥ 4.0	0.70

Table 2.3.4-4 (A) – Values of factor s

Wave steepness figures for the open ocean corresponding to wind pressure, $P = 504 \text{ Pa (N/m}^2\text{)}$ (Ref SLF 51/4/1 Annex 1, Table 1).

T	s
≤ 6	0.100
7	0.098
8	0.093
12	0.065
14	0.053
16	0.044
18	0.038
20	0.035
22	0.030
24	0.026

26	0.024
28	0.022
30	0.020

(Intermediate values in these tables shall be obtained by linear interpolation. **If values lie outside of the range, see 2.3.5, below, or refer to the MCA. (The extension to the range in the above table was agreed to by the EC on 22nd November 2007).**

2.3.5 The tables and formulae described in 2.3.4 are based on data from ships having:

- .1 B/d smaller than **6.5**;
- .2 $(KG/d-1)$ between -0.3 and 0.5;
- .3 T smaller than 20 seconds.

For ships with parameters outside of the above limits the angle of roll (ϕ_1) may be determined with model experiments of a subject ship¹² ~~with the procedure described in MSC.1/Circ.1200 as the alternative~~. In addition, the MCA may accept such alternative determinations for any ship, if deemed appropriate. **For example, based on IMO paper SLF 51/4/1 Annex 1 Table 5, the MCA will permit use of the following table for wave steepness in UK categorized waters, in conjunction with a wind pressure of 168 Pa (N/m²).**

Table 2.3.4-4 (B) – Values of factor s

Wave steepness figures for UK categorized waters corresponding to wind pressure $P = 168$ Pa (N/m²)

T	s
3.5	0.100
4.0	0.099
4.5	0.096
5.0	0.090
7.0	0.064
9.0	0.042
9.5	0.038
10.0	0.037
10.5	0.035

Note: the above deletion in 2.3.5 and addition of new footnote ¹² below is from MSC 85/26/Add.1/Corr.3/Rev.1 dated 9 October 2018: -

¹² Refer to the procedure described in the Interim guidelines for alternative assessment of the weather criterion (MSC.1/Circ.1200).

Part A Chapter 3- Special Criteria for certain types of ships

3.1 Passenger ships

Passenger ships shall comply with the requirements of 2.2 and 2.3.

3.1.1 In addition, the angle of heel on account of crowding of passengers to one side as defined below shall not exceed 10°.

3.1.1.1 A minimum weight of 75 kg shall be assumed for each passenger except that this value may be increased subject to the approval of the [MCA](#). In addition, the mass and distribution of the luggage shall be approved by the [MCA](#).

3.1.1.2 The height of the centre of gravity for passengers shall be assumed equal to:

- .1 1.0 m above deck level for passengers standing upright. Account may be taken, if necessary, of camber and sheer of deck; and
- .2 0.30 m above the seat in respect of seated passengers.

3.1.1.3 Passengers and luggage shall be considered to be in the spaces normally at their disposal, when assessing compliance with the criteria given in 2.2.1 to 2.2.4.

3.1.1.4 Passengers without luggage shall be considered as distributed to produce the most unfavourable combination of passenger heeling moment and/or initial metacentric height, which may be obtained in practice, when assessing compliance with the criteria given in 3.1.1 and 3.1.2, respectively. In this connection, a value higher than four persons per square metre is not necessary.

3.1.2 In addition, the angle of heel on account of turning shall not exceed 10° when calculated using the following formula:

$$M_R = 0.200 * \frac{v_o^2}{L_{WL}} * \Delta * \left(KG - \frac{d}{2} \right)$$

where:

- M_R = heeling moment (kNm)
- v_o = service speed (m/s)
- L_{WL} = length of ship at waterline (m)
- Δ = displacement (t)
- d = mean draught (m)
- KG = height of centre of gravity above baseline (m)

3.2 Oil tankers of 5,000 dwt and above

Oil tankers, as defined in section 2 (Definitions) of the Introduction, shall comply with regulation 27 of Annex I to MARPOL 73/78.

3.3 Cargo ships carrying timber deck cargoes

Cargo ships carrying timber deck cargoes shall comply with the requirements of 2.2 and 2.3 unless the MCA is satisfied with the application of alternative provision 3.3.2.

3.3.1 Scope

The provisions given hereunder apply to all ships of 24 m in length and over engaged in the carriage of timber deck cargoes. Ships that are provided with, and make use of, their timber load line shall also comply with the requirements of regulations 41 to 45 of the 1966 Load Line Convention.

3.3.2 Alternative stability criteria

For ships loaded with timber deck cargoes and provided that the cargo extends longitudinally between superstructures (where there is no limiting superstructure at the after end, the timber deck cargo shall extend at least to the after end of the aftermost hatchway)⁹ transversely for the full beam of ship, after due allowance for a rounded gunwale, not exceeding 4% of the breadth of the ship and/or securing the supporting uprights and which remains securely fixed at large angles of heel may be:

3.3.2.1 The area under the righting lever curve (GZ curve) shall not be less than 0.08 metre-radians up to $\varphi = 40^\circ$ or the angle of flooding if this angle is less than 40° .

3.3.2.2 The maximum value of the righting lever (GZ) shall be at least 0.25 m.

3.3.2.3 At all times during a voyage, the metacentric height GM_0 shall not be less than 0.1 m, taking into account the absorption of water by the deck cargo and/or ice accretion on the exposed surfaces.¹⁴ ~~(details regarding ice accretion are given in part B, chapter 6 (Icing considerations)).~~

3.3.2.4 When determining the ability of the ship to withstand the combined effects of beam wind and rolling according to 2.3, the 16° limiting angle of heel under action of steady wind shall be complied with, but the additional criterion of 80% of the angle of deck edge immersion may be ignored.

⁹ Refer to regulation 44(2) of the International Convention on Load Lines, 1966 or the Protocol of 1988 relating thereto as amended, as applicable.

¹⁴ Details regarding ice accretion are given in chapter 6 (Icing considerations) of part B

Note: the above deletion in 3.3.2.3 and the new footnote ¹⁴ is from MSC 85/26/Add.1/Corr.3/Rev.1 dated 9 October 2018.

3.4 Cargo ships carrying grain in bulk

The intact stability of ships engaged in the carriage of grain shall comply with the requirements of the International Code for the Safe Carriage of Grain in Bulk adopted by resolution MSC.23(59).¹⁰

3.5 High-speed craft

High-speed craft, as defined in section 2 (Definitions) of the Introduction, constructed on or after 1 January 1996, to which chapter X of the 1974 SOLAS Convention applies, shall comply with the stability requirements of the 1994 HSC Code (resolution MSC.36(63)). Any high-speed craft to which chapter X of the 1974 SOLAS Convention applies, irrespective of its date of construction, which has undergone repairs, alterations or modifications of major character; and a high-speed craft constructed on or after 1 July 2002, shall comply with stability requirements of the 2000 HSC Code (resolution MSC.97(73)).

¹⁰ Refer to part C of chapter VI of the 1974 SOLAS Convention as amended by resolution MSC.23(59).

PART B

RECOMMENDATIONS FOR SHIPS ENGAGED IN CERTAIN TYPES OF OPERATIONS, CERTAIN TYPES OF SHIPS AND ADDITIONAL GUIDELINES

Note: the amendments highlighted are from MSC.415(97) and enter into force 1st January 2020

Part B Chapter 1- General

1.1 Purpose

The purpose of this part of the Code is to:

- .1 recommend stability criteria and other measures for ensuring the safe operation of certain types of ships to minimize the risk to such ships, to the personnel on board and to the environment; and
- .2 provide guidelines for stability information, operational provisions against capsizing, icing considerations, considerations for watertight integrity and the determination of lightship parameters.

1.2 Application

1.2.1 This part of the Code contains recommended intact stability criteria for certain types of ships and other marine vehicles not included in part A or intended to supplement those of part A in particular cases regarding size or operation.

1.2.2 The recommendations contained herein may also apply to other ships subject to similar external forces, when determining the adequacy of stability.

1.2.3 The MCA may impose additional requirements regarding the design aspects of ships of novel design or ships not otherwise covered by the Code.

1.2.4 The criteria stated in this part should give guidance to Administrations if no national requirements are applied.

Part B Chapter 2- Recommended design criteria for ships engaged in certain types of operations and certain types of ships**2.1 Fishing vessels****2.1.1 Scope**

The provisions given hereunder apply to decked seagoing fishing vessels as defined in Definitions. The stability criteria given in 2.1.3 and 2.1.4 below should be complied with for all conditions of loading as specified in 3.4.1.6, unless the [MCA](#) is satisfied that operating experience justifies departures therefrom.

2.1.2 General precautions against capsizing

Apart from general precautions referred to in part B, 5.1, 5.2 and 5.3, the following measures should be considered as preliminary guidance on matters influencing safety as related to stability:

- .1 all fishing gear and other heavy material should be properly stowed and placed as low in the vessel as possible;
- .2 particular care should be taken when pull from fishing gear might have a negative effect on stability, e.g., when nets are hauled by power-block or the trawl catches obstructions on the sea-bed. The pull of the fishing gear should be from as low a point on the vessel, above the waterline, as possible;
- .3 gear for releasing the deck load in fishing vessels which carry the catch on deck, e.g., herring, should be kept in good working condition;
- .4 when the main deck is prepared for carrying deck load by dividing it with pound boards, there should be slots between them of suitable size to allow easy flow of water to freeing ports, thus preventing trapping of water;
- .5 to prevent a shift of the fish load carried in bulk, portable divisions in the holds should be properly installed;
- .6 reliance on automatic steering may be dangerous as this prevents changes to course which may be needed in bad weather;
- .7 necessary care should be taken to maintain adequate freeboard in all loading conditions, and where load line regulations are applicable they should be strictly adhered to at all times; and
- .8 particular care should be taken when the pull from fishing gear results in dangerous heel angles. This may occur when fishing gear fastens onto an underwater obstacle or when handling fishing gear, particularly on purse seiners, or when one of the trawl wires tears off. The heel angles caused by the fishing gear in these situations may be eliminated by employing devices which can relieve or remove excessive forces applied through the fishing gear. Such devices should not impose a danger to the vessel through operating in circumstances other than those for which they were intended.

2.1.3 Recommended general criteria¹¹

2.1.3.1 The general intact stability criteria given in part A, 2.2.1 to 2.2.3 should apply to fishing vessels having a length of 24 m and over, with the exception of requirements on the initial metacentric height GM, (part A, 2.2.4), which, for fishing vessels, should not be less than 0.35 m for single-deck vessels. In vessels with complete superstructure or vessels of 70 m in length and over the metacentric height may be reduced to the satisfaction of the MCA but in no case should be less than 0.15 m.

2.1.3.2 The adoption by individual countries of simplified criteria which apply such basic stability values to their own types and classes of vessels is recognized as a practical and valuable method of economically judging the stability.

2.1.3.3 Where arrangements other than bilge keels are provided to limit the angle of roll, the MCA should be satisfied that the stability criteria referred to in 2.1.3.1 are maintained in all operating conditions.

2.1.4 Severe wind and rolling criterion (weather criterion) for fishing vessels

2.1.4.1 The MCA may apply the provisions of part A, 2.3 to fishing vessels of 45 m length and over.

2.1.4.2 For fishing vessels in the length range between 24 m and 45 m, the MCA may apply the provisions of part A, 2.3. Alternatively the values of wind pressure (see part A, 2.3.2) may be taken from the following table:

<i>h</i> (m)	1	2	3	4	5	6 and over
<i>P</i> (Pa)	316	386	429	460	485	504

where *h* is the vertical distance from the centre of the projected vertical area of the vessel above the waterline, to the waterline.

2.1.5 Recommendation for an interim simplified stability criterion for decked fishing vessels under 30 m in length

2.1.5.1 For decked vessels with a length less than 30 m, the following approximate formula for the minimum metacentric height GM_{min} (in metres) for all operating conditions should be used as the criterion:

$$GM_{min} = 0.53 + 2B \left[0.075 - 0.37 \left(\frac{f}{B} \right) + 0.82 \left(\frac{f}{B} \right)^2 - 0.014 \left(\frac{B}{D} \right) - 0.032 \left(\frac{l_s}{L} \right) \right]$$

where:

L is the length of the vessel on the waterline in maximum load condition (m)

l_s is the actual length of enclosed superstructure extending from side to side of the vessel (m)

¹¹ Refer to regulation III/2 of the 1993 Torremolinos Protocol.

B is the extreme breadth of the vessel on the waterline in maximum load condition (m)

D is the depth of the vessel measured vertically amidships from the base line to the top of the upper deck at side (m)

f is the smallest freeboard measured vertically from top of the upper deck at side to the actual waterline (m).

The formula is applicable for vessels having:

- .1 f/B between 0.02 and 0.20;
- .2 l_s/L smaller than 0.60;
- .3 B/D between 1.75 and 2.15;
- .4 sheer fore and aft at least equal to or exceeding the standard sheer prescribed in regulation 38(8) of the International Convention on Load Lines, 1966 or the Protocol of 1988 as amended, as applicable; and
- .5 height of superstructure included in the calculation is not less than 1.8 m.

For ships with parameters outside the above limits the formula should be applied with special care.

2.1.5.2 The above formula is not intended as a replacement for the basic criteria given in 2.1.3 and 2.1.4 but is to be used only if circumstances are such that cross curves of stability, KM curve and subsequent GZ curves are not and cannot be made available for judging a particular vessel's stability.

2.1.5.3 The calculated value of GM, should be compared with actual GM values of the vessel in all loading conditions. If an inclining experiment based on estimated displacement, or another approximate method of determining the actual GM is used, a safety margin should be added to the calculated GM_{min} .

2.2 Pontoons

2.2.1 Application

The provisions given hereunder apply to seagoing pontoons. A pontoon is considered to be normally:

- .1 non self-propelled;
- .2 unmanned;
- .3 carrying only deck cargo;
- .4 having a block coefficient of 0.9 or greater;
- .5 having a breadth/depth ratio of greater than 3.0; and
- .6 having no hatchways in the deck except small manholes closed with gasketed covers.

2.2.2 Stability drawings and calculations

The following information is typical of that required to be submitted to the [MCA](#) for approval:

- .1 lines drawing;
- .2 hydrostatic curves;
- .3 cross curves of stability;
- .4 report of draught and density readings and calculation of lightship displacement and longitudinal centre of gravity;
- .5 statement of justification of assumed vertical centre of gravity; and
- .6 simplified stability guidance such as a loading diagram, so that the pontoon may be loaded in compliance with the stability criteria.

2.2.3 Concerning the performance of calculations

The following guidance is suggested:

- .1 no account should be taken of the buoyancy of deck cargo (except buoyancy credit for adequately secured timber);
- .2 consideration should be given to such factors as water absorption (e.g., timber), trapped water in cargo (e.g., pipes) and ice accretion;
- .3 in performing wind heel calculations:
 - .3.1 the wind pressure should be constant and for general operations be considered to act on a solid mass extending over the length of the cargo deck and to an assumed height above the deck;
 - .3.2 the centre of gravity of the cargo should be assumed at a point mid-height of the cargo; and
 - .3.3 the wind lever should be taken from the centre of the deck cargo to a point at one half the mean draught;
- .4 calculations should be performed covering the full range of operating draughts; and
- .5 the down-flooding angle should be taken as the angle at which an opening through which progressive flooding may take place is immersed. This would not be an opening closed by a watertight manhole cover or a vent fitted with an automatic closure.

2.2.4 Intact stability criteria

2.2.4.1 The area under the righting lever curve up to the angle of maximum righting lever should not be less than 0.08 metre-radians.

2.2.4.2 The static angle of heel due to a uniformly distributed wind load of 540Pa (wind speed 30 m/s) should not exceed an angle corresponding to half the freeboard for the relevant loading condition, where the lever of wind heeling moment is measured from the centroid of the windage area to half the draught.

2.2.4.3 The minimum range of stability should be:

For $L \leq 100\text{m}$	20°
For $L \geq 150\text{m}$	15°
For intermediate length	by interpolation.

2.3 Containerships greater than 100 m

2.3.1 *Application*¹²

These requirements apply to containerships greater than 100 m in length as defined in paragraph 2 of the Introduction (Definitions). They may also be applied to other cargo ships in this length range with considerable flare or large water plane areas. The MCA may apply the following criteria instead of those in part A, 2.2.

2.3.2 *Intact stability*

2.3.2.1 The area under the righting lever curve (GZ curve) should not be less than $0.009/C$ metre-radians up to $\varphi = 30^\circ$ angle of heel, and not less than $0.016/C$ metre-radians up to $\varphi = 40^\circ$ or the angle of flooding φ_f (as defined in part A, 2.2) if this angle is less than 40° .

2.3.2.2 Additionally, the area under the righting lever curve (GZ curve) between the angles of heel of 30° and 40° or between 30° and φ_f , if this angle is less than 40° , should not be less than $0.006/C$ metre-radians.

2.3.2.3 The righting lever GZ should be at least $0.033/C$ m at an angle of heel equal or greater than 30° .

2.3.2.4 The maximum righting lever GZ should be at least $0.042/C$ m.

2.3.2.5 The total area under the righting lever curve (GZ curve) up to the angle of flooding φ_f should not be less than $0.029/C$ metre-radians.

¹² Since the criteria in this section were empirically developed with the data of containerships less than 200 m in length, they should be applied to ships beyond such limits with special care.

2.3.2.6 In the above criteria the form factor C should be calculated using the formula and figure 2.3-1:

$$C = \frac{d D'}{B_m^2} \sqrt{\frac{d}{KG}} \left(\frac{C_B}{C_W} \right)^2 \sqrt{\frac{100}{L}}$$

where:

- d = mean draught (m)
- D' = moulded depth of the ship, corrected for defined parts of volumes within the hatch coamings according to the formula:

$$D' = D + h \left(\frac{2b - B_D}{B_D} \right) \left(\frac{2 \sum l_H}{L} \right), \text{ as defined in figure 2.3-1;}$$

- D = moulded depth of the ship (m);
- B_D = moulded breadth of the ship (m);
- KG = height of the centre of mass above base, corrected for free surface effect, not be taken as less than d (m);
- C_B = block coefficient;
- C_W = water plane coefficient;
- l_H = length of each hatch coaming within L/4 forward and aft from amidships (m) (see figure 2.3-1);
- b = mean width of hatch coamings within L/4 forward and aft from amidships (m) (see figure 2.3-1);
- h = mean height of hatch coamings within L/4 forward and aft from amidships (m) (see figure 2.3-1);
- L = length of the ship (m);
- B = breadth of the ship on the waterline (m);
- B_m = breadth of the ship on the waterline at half mean draught (m).

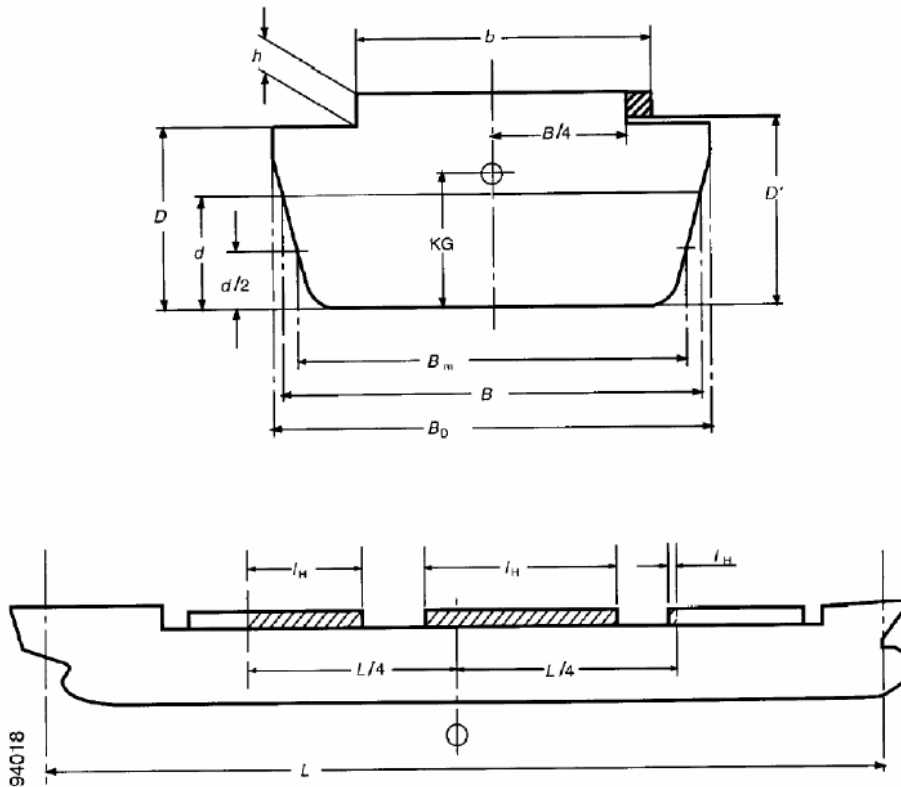

Figure 2.3-1

The shaded areas in figure 2.3-1 represent partial volumes within the hatch coamings considered contributing to resistance against capsizing at large heeling angles when the ship is on a wave crest.

2.3.2.7 The use of electronic loading and stability instrument is encouraged in determining the ship's trim and stability during different operational conditions.

2.4 Offshore supply vessels

2.4.1 Application

2.4.1.1 The provisions given hereunder apply to offshore supply vessels, as defined in section 2 (Definitions) of the Introduction, of 24 m in length and over. The alternative stability criteria contained in 2.4.5 apply to vessels of not more than 100 m in length.

2.4.1.2 For a vessel engaged in near-coastal voyages, as defined in Definitions, the principles given in 2.4.2 should guide the Administration in the development of its national standards. Relaxations from the requirements of the Code may be permitted by the MCA for vessels engaged in near-coastal voyages off its own coasts provided the operating conditions are, in the opinion of the MCA, such as to render compliance with the provisions of the Code unreasonable or unnecessary.

2.4.1.3 Where a ship other than an offshore supply vessel, as defined in Definitions, is employed on a similar service, the Administration should determine the extent to which compliance with the provisions of the Code is required.

2.4.2 Principles governing near-coastal voyages

2.4.2.1 The Administration defining near-coastal voyages for the purpose of the present Code should not impose design and construction standards for a vessel entitled to fly the flag of another State and engaged in such voyages in a manner resulting in a more stringent standard for such a vessel than for a vessel entitled to fly its own flag. In no case should the Administration impose, in respect of a vessel entitled to fly the flag of another State, standards in excess of the Code for a vessel not engaged in near-coastal voyages.

2.4.2.2 With respect to a vessel regularly engaged in near-coastal voyages off the coast of another State the Administration should prescribe design and construction standards for such a vessel at least equal to those prescribed by the Government of the State off whose coast the vessel is engaged, provided such standards do not exceed the Code in respect of a vessel not engaged in near-coastal voyages.

2.4.2.3 A vessel which extends its voyages beyond a near-coastal voyage should comply with the present Code.

2.4.3 Constructional precautions against capsizing

2.4.3.1 Access to the machinery space should, if possible, be arranged within the forecastle. Any access to the machinery space from the exposed cargo deck should be provided with two weathertight closures. Access to spaces below the exposed cargo deck should preferably be from a position within or above the superstructure deck.

2.4.3.2 The area of freeing ports in the side bulwarks of the cargo deck should at least meet the requirements of regulation 24 of the International Convention on Load Lines, 1966 or the Protocol of 1988 relating thereto, as amended, as applicable. The disposition of the freeing ports should be carefully considered to ensure the most effective drainage of water trapped in pipe deck cargoes or in recesses at the after end of the forecastle. In vessels operating in areas where icing is likely to occur, no shutters should be fitted in the freeing ports.

2.4.3.3 The Administration should give special attention to adequate drainage of pipe stowage positions having regard to the individual characteristics of the vessel. However, the area provided for drainage of the pipe stowage positions should be in excess of the required freeing port area in the cargo deck bulwarks and should not be fitted with shutters.

2.4.3.4 A vessel engaged in towing operations should be provided with means for quick release of the ~~towing hawser~~ towline. *

2.4.4 Operational procedures against capsizing

2.4.4.1 The arrangement of cargo stowed on deck should be such as to avoid any obstruction of the freeing ports or of the areas necessary for the drainage of pipe stowage positions to the freeing ports.

2.4.4.2 A minimum freeboard at the stern of at least 0.005 *L* should be maintained in all operating conditions.

* Vessels provided with towing winch systems should also be provided with means of quick release.

Note: the amendments highlighted are from MSC.415(97) and enter into force 1st January 2020

2.4.5 *Stability criteria*

2.4.5.1 The stability criteria given in part A, 2.2 should apply to all offshore supply vessels except those having characteristics which render compliance with part A, 2.2 impracticable.

2.4.5.2 The following equivalent criteria should be applied where a vessel's characteristics render compliance with part A, 2.2 impracticable:

- .1 the area under the curve of righting levers (GZ curve) should not be less than 0.070 metre-radians up to an angle of 15° when the maximum righting lever (GZ) occurs at 15° and 0.055 metre-radians up to an angle of 30° when the maximum righting lever (GZ) occurs at 30° or above. Where the maximum righting lever (GZ) occurs at angles of between 15° and 30°, the corresponding area under the righting lever curve should be:

$$0.055 + 0.001 (30^\circ - \varphi_{\max}) \text{ metre-radians}^{13};$$
- .2 the area under the righting lever curve (GZ curve) between the angles of heel of 30° and 40°, or between 30° and φ_f if this angle is less than 40°, should be not less than 0.03 metre-radians;
- .3 the righting lever (GZ) should be at least 0.20 m at an angle of heel equal to or greater than 30°;
- .4 the maximum righting lever (GZ) should occur at an angle of heel not less than 15°;
- .5 the initial transverse metacentric height (GMo) should not be less than 0.15 m; and
- .6 reference is made also to part A, 2.1.3 to 2.1.5 and part B, 5.1.

2.5 *Special purpose ships*

2.5.1 *Application*

The provisions given hereunder apply to special purpose ships, as defined in section 2 (Definitions) of the Introduction, of not less than 500 gross tonnage. The MCA may also apply these provisions as far as reasonable and practicable to special purpose ships of less than 500 gross tons.

2.5.2 *Stability criteria*

The intact stability of special purpose ships should comply with the provisions given in part A, 2.2 except that the alternative criteria given in part B, 2.4.5 which apply to offshore supply vessels may be used for special purpose ships of less than 100 m in length of similar design and characteristics.

¹³ φ_{\max} is the angle of heel in degrees at which the righting lever curve reaches its maximum.

2.6 Mobile offshore drilling units (MODUs)

For MODUs, constructed:

- .1 on or after 1 January 2012, the provisions of chapter 3 of the 2009 MODU Code, adopted by resolution A.1023(26), should apply;
- .2 before 1 January 2012, but on or after 1 May 1991, the provisions of chapter 3 of the 1989 MODU Code, adopted by resolution A.649(16), should apply; and
- .3 before 1 May 1991, the provisions of chapter 3 of the 1979 MODU Code, adopted by resolution A.414(XI), should apply.

NOTES: -

1. The above text for 2.6, taken from resolution MSC.319(89), replaces paragraphs 2.6.1 to 2.6.4.5 in the 2009 Edition of the Intact Stability, 2008, Code as from 20 May 2011.
2. The amendments highlighted below are from MSC.415(97) and enter into force 1 January 2020

2.7 Ships engaged in anchor handling operations

2.7.1 Application

2.7.1.1 The provisions given hereunder apply to ships engaged in anchor handling operations.

2.7.1.2 A wire means a dedicated line (wire rope, synthetic rope or chain cable) used for the handling of anchors by means of an anchor handling winch.

2.7.2 Heeling levers

2.7.2.1 A heeling lever, HL_φ , generated by the action of a heeling moment caused by the vertical and horizontal components of the tension applied to the wire should be calculated as:

$$HL_\varphi = (M_{AH} / \Delta_2) \cos \varphi$$

where:

$$M_{AH} = F_p \times (h \sin \alpha \times \cos \beta + y \times \sin \beta);$$

Δ_2 = displacement of a loading condition, including action of the vertical loads added (F_v), at the centreline in the stern of ship;

$$F_v = F_p \times \sin \beta;$$

α = the horizontal angle between the centreline and the vector at which the wire tension is applied to the ship in the upright position, positive outboard;

β = the vertical angle between the waterplane and the vector at which the wire tension is applied to the ship, positive downwards, should be taken at the maximum heeling moment angle as $\tan^{-1}(y / (h \times \sin \alpha))$, but not less than $\cos^{-1}(1.5 B_P / (F_P \cos \alpha))$, using consistent units;

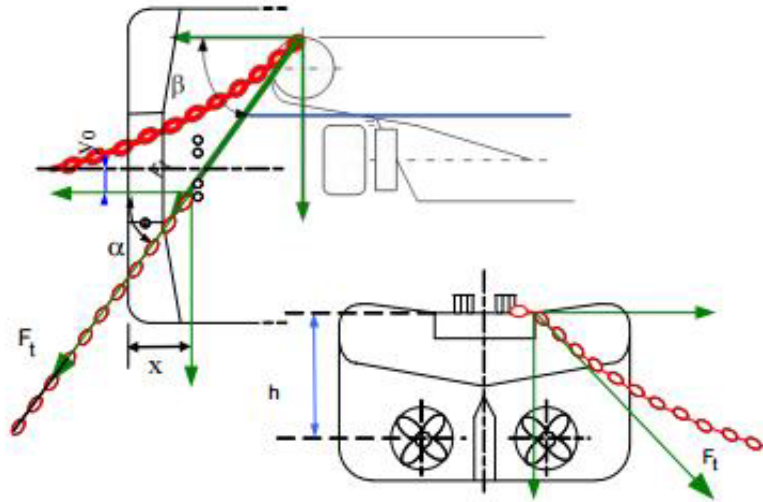

Figure 2.7-1 – Diagrams showing the intended meaning of parameters α , β , x , y and h . F_t shows the vector of the applied wire tension.

- B_P = the Bollard pull that is the documented maximum continuous pull obtained from a static pull test on sea trial, carried out in accordance with annex A of MSC/Circ.884 or an equivalent standard acceptable to the **MCA**;
- F_p = (Permissible tension) the wire tension which can be applied to the ship as loaded while working through a specified tow pin set, at each α , for which all stability criteria can be met. F_p should in no circumstance be taken as greater than F_d ;
- F_d = (Design maximum wire tension) the maximum winch wire pull or maximum static winch brake holding force, whichever is greater;
- h = the vertical distance (m) from the centre the propulsive force acts on the ship to either:
- the uppermost part at the towing pin,
 - or a point on a line defined between the highest point of the winch pay-out and the top of the stern or any physical restriction of the transverse wire movement;
- y = the transverse distance (m) from the centreline to the outboard point at which the wire tension is applied to the ship given by:
- $y_0 + x \tan \alpha$; but not greater than $B/2$;
- B = the moulded breadth (m);
- y_0 = the transverse distance (m) between the ship centreline to the inner part of the towing pin or any physical restriction of the transverse wire movement;
- x = the longitudinal distance (m) between the stern and the towing pin or any physical restriction of the transverse wire movement.

2.7.3 Permissible tension

2.7.3.1 The permissible tension as function of α , defined in paragraph 2.7.2, should not be greater than the tension given by paragraph 2.7.3.2,

2.7.3.2 Permissible tension as function of α can be calculated by direct stability calculations, provided that the following are met:

- .1 the heeling lever should be taken as defined in paragraph 2.7.2 for each α ;
- .2 the stability criteria in paragraph 2.7.4, should be met;
- .3 α should not be taken less than 5 degrees, except as permitted by paragraph 2.7.3.3; and
- .4 Intervals of α should not be more than 5 degrees, except that larger intervals may be accepted, provided that the permissible tension is limited to the higher α by forming working sectors.

2.7.3.3 For the case of a planned operation to retrieve a stuck anchor in which the ship is on station above the anchor and the ship has low or no speed, α may be taken as less than 5 degrees.

2.7.4 Stability criteria

2.7.4.1 For the loading conditions intended for anchor handling, but before commencing the operation, the stability criteria given in paragraph 2.2 of part A, or where a ship's characteristics render compliance with paragraph 2.2 of part A impracticable, the equivalent stability criteria given in paragraph 2.4 of part B, should apply. During operation, under the action of the heeling moment, the criteria under paragraphs 2.7.4.2 to 2.7.4.4 should apply.

2.7.4.2 The residual area between the righting lever curve and the heeling lever curve calculated in accordance with paragraph 2.7.2 should not be less than 0.070 metre-radians. The area is determined from the first intersection of the two curves, φ_e , to the angle of the second intersection, φ_c , or the angle of downflooding, φ_f , whichever is less.

2.7.4.3 The maximum residual righting lever GZ between the righting lever curve and the heeling lever curve calculated in accordance with paragraph 2.7.2 should be at least 0.2 m.

2.7.4.4 The static angle at the first intersection, φ_e , between the righting lever curve and the heeling lever curve calculated in accordance with paragraph 2.7.2 should not be greater than:

- .1 the angle at which the righting lever equals 50% of the maximum righting lever;
- .2 the deck edge immersion angle; or
- .3 15°,

whichever is less.

2.7.4.5 A minimum freeboard at stern, on centreline, of at least $0.005L$ should be maintained in all operating conditions, with a displacement given by Δ_2 , as defined in paragraph 2.7.2. In the case of the anchor retrieval operation covered by paragraph 2.7.3.3, a lower minimum freeboard may be accepted provided that due consideration has been given to this in the operation plan.

2.7.5 Constructional precautions against capsizing

2.7.5.1 A stability instrument may be used for determining the permissible tension and checking compliance with relevant stability criteria.

Two types of stability instrument may be used on board:

- either a software checking the intended or actual tension on the basis of the permissible tension curves; or
- a software performing direct stability calculations to check compliance with the relevant criteria, for a given loading condition (before application of the tension force), a given tension and a given wire position (defined by angles α and β).

2.7.5.2 Access to the machinery space, excluding emergency access and removal hatches, should, if possible, be arranged within the forecabin. Any access to the machinery space from the exposed cargo deck should be provided with two weathertight closures. Access to spaces below the exposed cargo deck should preferably be from a position within or above the superstructure deck.

2.7.5.3 The area of freeing ports in the side bulwarks of the cargo deck should at least meet the requirements of regulation 24 of the International Convention on Load Lines, 1966 or the Protocol of 1988 relating thereto, as amended, as applicable. The disposition of the freeing ports should be carefully considered to ensure the most effective drainage of water trapped in working deck and in recesses at the after end of the forecabin. In ships operating in areas where icing is likely to occur, no shutters should be fitted in the freeing ports.

2.7.5.4 The winch systems should be provided with means of emergency release.

2.7.5.5 For ships engaged in anchor handling operations the following recommendations for the anchor handling arrangements should be considered:

- .1 stop pins or other design features meant to impede the movement of the wire further outboard should be installed; and
- .2 the working deck should be marked with contrasting colours or other identifiers such as guide pins, stop pins or similar easily identifiable points that identify operational zones for the line to aid operator observation.

2.7.6 Operational procedures against capsizing

2.7.6.1 A comprehensive operational plan should be defined for each anchor handling operation, according to the guidelines given in paragraph 3.8, where at least, but not only, the following procedures and emergency measures should be identified:

- .1 environmental conditions for the operation;
- .2 winch operations and movements of weights;
- .3 compliance with the stability criteria, for the different expected loading conditions;
- .4 permissible tensions on the winches as function of α ; in accordance with paragraph 3.8;
- .5 stop work and corrective procedures; and
- .6 confirmation of the master's duty to take corrective action when necessary.

2.7.6.2 The arrangement of cargo stowed on deck should be such as to avoid any obstruction of

the freeing ports or sudden shift of cargo on deck.

2.7.6.3 Counter-ballasting to correct the list of the ship during anchor handling operations should be avoided.

2.8 Ships engaged in towing and escort operations

2.8.1 Application

The provisions given hereunder apply to ships the keel of which is laid or which is at a similar stage of construction* on or after 1 January 2020 engaged in harbour towing, coastal or ocean-going towing and escort operations and to ships converted to carry out towing operations after this date.

2.8.2 Heeling lever for towing operations

2.8.2.1 The self-tripping heeling lever is calculated as provided below:

- .1 A transverse heeling moment is generated by the maximum transverse thrust exerted by the ship's propulsion and steering systems and the corresponding opposing towline pull.
- .2 The heeling lever $HL\varphi$, in (m), as a function of the heeling angle φ , should be calculated according to the following formula:

$$HL\varphi = \frac{BP \times C_T \times (h \times \cos \varphi - r \times \sin \varphi)}{g \times \Delta}$$

where:

BP = bollard pull, in (kN), which is the documented maximum continuous pull obtained from a static bollard pull test performed in accordance with relevant IMO guidelines** or a standard acceptable to the MCA;

C_T =

- 0.5, for ships with conventional, non-azimuth propulsion units;
- $0.90/(1 + l/L_{LL})$, for ships with azimuth propulsion units installed at a single point along the length. However, C_T should not be less than 0.7 for ships with azimuth stern drive towing over the stern or tractor tugs towing over the bow, and not less than 0.5 for ships with azimuth stern drive towing over the bow or tractor tugs towing over the stern;

For tugs with other propulsion and/or towing arrangements, the value of C_T is to be established on a case by case basis to the satisfaction of the MCA

* A similar stage of construction means the stage at which:

- .1 construction identifiable with a specific ship begins; and
- .2 assembly of that ship has commenced, comprising at least 50 tonnes or 1% of the estimated mass of all structural material, whichever is less.

** Refer to Annex A to the *Guidelines for safe ocean towing* (MSC/Circ.884)

Δ = displacement, in (t);

- l = longitudinal distance, in (m), between the towing point and the vertical centreline of the propulsion unit(s) relevant to the towing situation considered;
- h = vertical distance, in (m), between the towing point and the horizontal centreline of the propulsion unit(s) as relevant for the towing situation considered;
- g = gravitational acceleration, in (m/s²), to be taken as 9.81;
- r = the transverse distance, in (m), between the centre line and the towing point, to be taken as zero when the towing point is at the centre line.
- L_{LL} = length (L) as defined in the International Convention on Load Lines in force.

The towing point is the location where the towline force is applied to the ship. The towing point may be a towing hook, staple, fairlead or equivalent fitting serving that purpose.

2.8.2.2 The tow-tripping heeling lever $HL\phi$, in (m), is calculated according to the following formula:

$$HL\phi = C_1 \times C_2 \times \gamma \times V^2 \times A_p \times (h \times \cos \phi - r \times \sin \phi + C_3 \times d) / (2 \times g \times \Delta)$$

where:

$$C_1 = \text{lateral traction coefficient} = 2.8 (L_s / L_{pp} - 0.1) \quad 0.10 \leq C_1 \leq 1.00$$

$$C_2 = \text{correction of } C_1 \text{ for angle of heel} = (\phi / (3 \cdot \phi_D) + 0.5) \quad C_2 \geq 1.00$$

$$\text{Angle to deck edge } \phi_D = \arctan (2f / B)$$

C_3 = distance from the centre of AP to the waterline as fraction of the draught related to the heeling angle

$$C_3 = (\phi / \phi_D) \times 0.26 + 0.30 \quad 0.50 \leq C_3 \leq 0.83$$

γ = specific gravity of water, in (t/m³);

V = lateral velocity, in (m/s), to be taken as 2.57 (5 knots);

A_p = lateral projected area, in (m²), of the underwater hull;

r = the transverse distance, in (m), between the centre line and the towing point, to be taken as zero when the towing point is at the centre line;

L_s = the longitudinal distance, in (m), from the aft perpendicular to the towing point;

L_{pp} = length between perpendiculars, in (m);

ϕ = angle of heel;

f = freeboard amidship, in (m);

B = moulded breadth, in (m);

H = vertical distance, in (m), from the waterline to the towing point;

d = actual mean draught, in (m).

The towing point is the location where the towline force is applied to the ship.

The towing point may be a towing hook, staple, fairlead or equivalent fitting serving that purpose.

2.8.3 Heeling lever for escort operations

2.8.3.1 For the evaluation of the stability particulars during escort operations the ship is considered to be in an equilibrium position determined by the combined action of the hydrodynamic forces acting on hull and appendages, the thrust force and the towline force as shown in figure 2.8-1.

2.8.3.2 For each equilibrium position the corresponding steering force, braking force, heel angle and heeling lever are to be obtained from the results of full-scale trials, model tests, or numerical simulations in accordance with a methodology acceptable to the MCA.

2.8.3.3 For each relevant loading condition the evaluation of the equilibrium positions is to be performed over the applicable escort speed range, whereby the speed of the assisted ship through the water is to be considered. *

2.8.3.4 For each relevant combination of loading condition and escort speed, the maximum heeling lever is to be used for the evaluation of the stability particulars.

2.8.3.5 For the purpose of stability calculations the heeling lever is to be taken as constant.

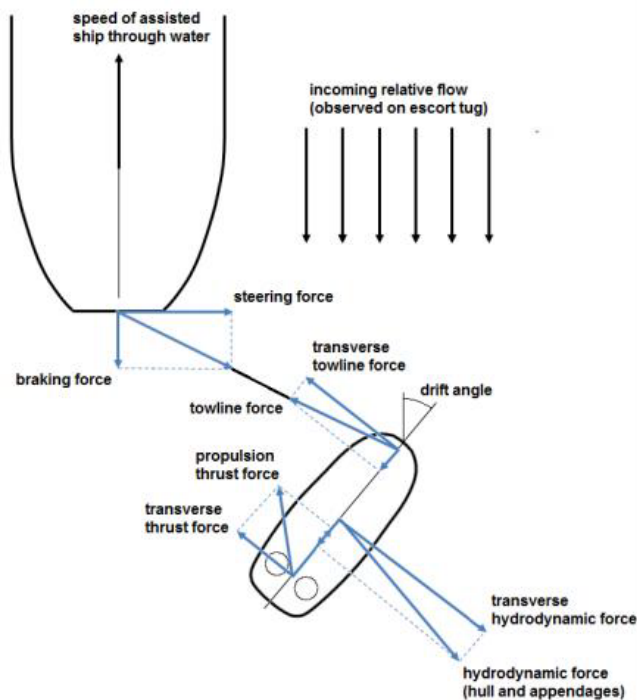

Figure 2.8-1: Escort tug equilibrium position

* The typical escort speed range is 6 to 10 knots.

2.8.4 Stability

2.8.4.1 In addition to the stability criteria given in part A, section 2.2, or the equivalent stability criteria given in chapter 4 of the explanatory notes to the 2008 IS Code where the ship's

characteristics render compliance with part A, section 2.2 impracticable, the following stability criteria should be complied with.

2.8.4.2 For ships engaged in harbour, coastal or ocean-going towing operations the area A contained between the righting lever curve and the heeling lever curve calculated in accordance with paragraph 2.8.2.1 (self-tripping), measured from the heel angle, φ_e , to the angle of the second intersection, φ_c , or the angle of down-flooding, φ_f , whichever is less, should be greater than the area B contained between the heeling lever curve and the righting lever curve, measured from the heel angle $\varphi = 0$ to the heel angle, φ_e .

where:

- φ_e = Angle of first intersection between the heeling lever and righting lever curves;
- φ_f = Angle of down-flooding as defined in part A, paragraph 2.3.1.4 of this Code. Openings required to be fitted with weathertight closing devices under the ICLL but, for operational reasons, are required to be kept open should be considered as downflooding points in stability calculation;
- φ_c = Angle of second intersection between the heeling lever and righting lever curves.

2.8.4.3 For ships engaged in harbour, coastal or ocean-going towing operations the first intersection between the righting lever curve and the heeling lever curve calculated in accordance with paragraph 2.8.2.2 (tow-tripping) should occur at an angle of heel less than the angle of down-flooding, φ_f .

2.8.4.4 For ships engaged in escort operations the maximum heeling lever determined in accordance with paragraph 2.8.3 should comply with the following criteria:

- .1 Area A \geq 1.25 \times Area B;
- .2 Area C \geq 1.40 \times Area D; and
- .3 $\varphi_e \leq$ 15 degrees.

where:

Area A = Righting lever curve area measured from the heel angle φ_e to a heel angle of 20 degrees (see figure 2.8-2);

Area B = Heeling lever curve area measured from the heeling angle φ_e to a heel angle of 20 degrees (see figure 2.8-2);

Area C = Righting lever curve area measured from the zero heel ($\varphi = 0$) to φ_d (see figure 2.8-3);

Area D = Heeling lever curve area measured from zero heel ($\varphi = 0$) to the heeling angle φ_d (see figure 2.8-3);

φ_e = Equilibrium heel angle corresponding to the first intersection between heeling lever curve and the righting lever curve;

φ_d = the heel angle corresponding to the second intersection between heeling lever curve and the righting lever curve or the angle of down-flooding or 40 degrees, whichever is less.

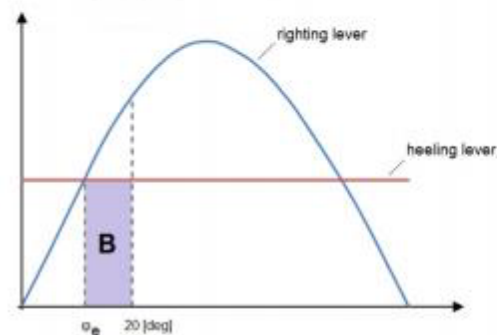
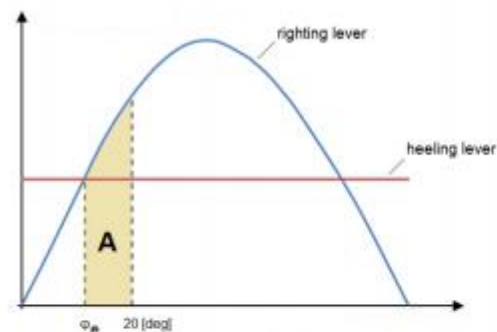
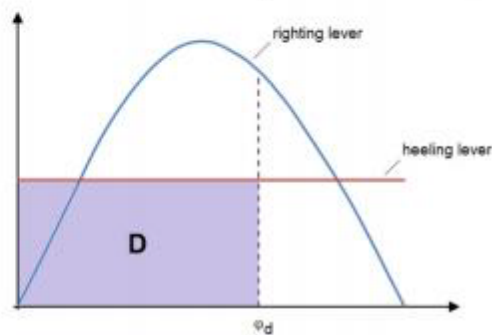
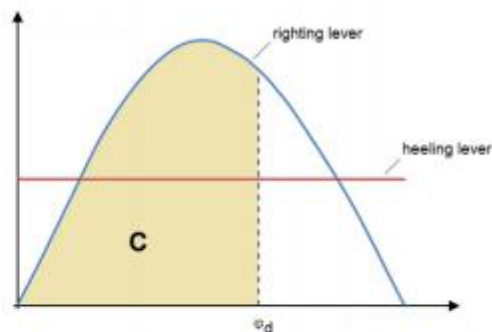
Figure 2.8-2: Areas A and B**Figure 2.8-3: Areas C and D**

2.8.5 Constructional precautions against capsizing

2.8.5.1 Access to the machinery space, excluding emergency access and removal hatches, should, if possible, be arranged within the forecastle. Any access to the machinery space from the exposed cargo deck should be provided with two weathertight closures, if practicable. Access to spaces below the exposed cargo deck should preferably be from a position within or above the superstructure deck.

2.8.5.2 The area of freeing ports in the side bulwarks of the cargo deck should at least meet the requirements of regulation 24 of the International Convention on Load Lines, 1966 or the Protocol of 1988 relating thereto, as amended, as applicable. The disposition of the freeing ports should be carefully considered to ensure the most effective drainage of water trapped on the working deck and in recesses at the after end of the forecastle. In ships operating in areas where icing is likely to occur, no shutters should be fitted in the freeing ports.

2.8.5.3 A ship engaged in towing operations should be provided with means for quick release of the towline. *

2.8.6 Operational procedures against capsizing

2.8.6.1 The arrangement of cargo stowed on deck should be such as to avoid any obstruction of the freeing ports or sudden shift of cargo on deck. Cargo on deck, if any, should not interfere with the movement of the towline.

2.8.6.2 A minimum freeboard at stern of at least $0.005 \times LLL$ should be maintained in all operating conditions.

* Ships provided with towing winch systems should also be provided with means of quick release.

2.9 Ships engaged in lifting operations

2.9.1 Application

2.9.1.1 The provisions given hereunder apply to ships the keel of which is laid or which is at a similar stage of construction* on or after 1 January 2020 engaged in lifting operations and to ships converted to carry out lifting operations after this date.

2.9.1.2 The provisions of this section should be applied to operations involving the lifting of the ship's own structures or for lifts in which the maximum heeling moment due to the lift is greater than that given in the following:

$$M_L = 0.67 \cdot \Delta \cdot GM \cdot (f / B)$$

Where:

M_L = Threshold value for the heeling moment, in (t.m), induced by the (lifting equipment and) load in the lifting equipment;

GM = The initial metacentric height, in (m), with free surface correction, including the effect of the (lifting equipment and) load in the lifting equipment;

f = the minimum freeboard, in (m), measured from the upper side of the weather deck to the waterline;

B = the moulded breadth of the ship, in (m); and

Δ = the displacement of the ship, including the lift load, in (t).

The provisions of this section also apply to ships which are engaged in lifting operations where no transverse heeling moment is induced and the increase of the ship's vertical centre of gravity (VCG) due to the lifted weight is greater than 1%.

The calculations should be completed at the most unfavourable loading conditions for which the lifting equipment shall be used.

2.9.1.3 For the purpose of this section, waters that are not exposed are those where the environmental impact on the lifting operation is negligible. Otherwise, waters are to be considered exposed. In general, waters that are not exposed are calm stretches of water, i.e. estuaries, roadsteads, bays, lagoons; where the wind fetch** is six nautical miles or less.

* A similar stage of construction means the stage at which:

- .1 construction identifiable with a specific ship begins; and
- .2 assembly of that ship has commenced, comprising at least 50 tonnes or 1% of the estimated mass of all structural material, whichever is less.

** Wind fetch is an unobstructed horizontal distance over which the wind can travel over water in a straight direction.

2.9.2 Load and vertical centre of gravity for different types of lifting operations

2.9.2.1 In lifting operations involving a lifting appliance consisting of a crane, derrick, sheerlegs, a-frame or similar:

- .1 the magnitude of the vertical load (PL) should be the maximum allowed static load at a given outreach of the lifting appliance;
- .2 the transverse distance (y) is the transverse distance between the point at which the vertical load is applied to the lifting appliance and the ship centreline in the upright position;
- .3 the vertical height of the load (KG_{load}) is taken as the vertical distance from the point at which the vertical load is applied to the lifting appliance to the baseline in the upright position; and
- .4 the change of centre of gravity of the lifting appliance(s) need to be taken into account.

2.9.2.2 In lifting operations not involving a lifting appliance consisting of a crane, derrick, sheerlegs, a-frame or similar, which involve lifting of fully or partially submerged objects over rollers or strong points at or near a deck-level:

- .1 the magnitude of the vertical load (PL) should be the winch brake holding load;
- .2 the transverse distance (y) is the transverse distance between the point at which the vertical load is applied to the ship and the ship centreline in the upright position; and
- .3 the vertical height of the load (KG_{load}) is taken as the vertical distance from the point at which the vertical load is applied to the ship to the baseline in the upright position.

2.9.3 Stability criteria

2.9.3.1 The stability criteria included herein, or the criteria contained in paragraphs 2.9.4, 2.9.5 or 2.9.7, as applicable shall be satisfied for all loading conditions intended for lifting with the lifting appliance and its load at the most unfavourable positions. For the purpose of this section, the lifting appliance and its load(s) and their centre of gravity (COG) should be included in the displacement and centre of gravity of the ship, in which case no external heeling moment/heeling lever is applied.

2.9.3.2 All loading conditions utilized during the lifting operations are to comply with the stability criteria given in sections 2.2 and 2.3 of part A. Where the ship's characteristics render compliance with section 2.2 of part A impracticable, the equivalent stability criteria given in chapter 4 of the explanatory notes to the 2008 IS Code should apply. During the lifting operation, as determined by paragraphs 2.9.1, the following stability criteria should also apply:

- .1 the equilibrium heel angle, ϕ_1 , shall not be greater than the maximum static heeling angle for which the lifting device is designed and which has been considered in the approval of the loading gear;
- .2 during lifting operations in non-exposed waters, the minimum distance between the water level and the highest continuous deck enclosing the watertight hull, taking into account trim and heel at any position along the length of the ship, shall not be less than 0.50 m; and
- .3 during lifting operations in exposed waters, the residual freeboard shall not be

less than 1.00 m or 75% of the highest significant wave height HS, in (m), encountered during the operation, whichever is greater.

2.9.4 Lifting operations conducted under environmental and operational limitations

2.9.4.1 For lifting conditions carried out within clearly defined limitations set forth in paragraph 2.9.4.1.1, the intact criteria set forth in paragraph 2.9.4.1.2 may be applied instead of the criteria included in paragraph 2.9.3.

.1 The limits of the environmental conditions should specify at least the following:

- the maximum significant wave height, HS; and
- the maximum wind speed (1 minute sustained at 10 m above sea level).

The limits of the operational conditions should specify at least the following:

- the maximum duration of the lift;
- limitations in ship speed; and
- limitations in traffic/traffic control.

.2 The following stability criteria should apply with the lifted load is at the most unfavourable position:

.1 the corner of the highest continuous deck enclosing the watertight hull shall not be submerged;

.2 $A_{RL} > 1.4 \times A_{HL}$

Where:

A_{RL} = The area under the net righting lever curve, corrected for crane heeling moment and for the righting moment provided by the counter ballast if applicable, extending from the equilibrium heeling angle, ϕ_1 , to the angle of down flooding, ϕ_F , the angle of vanishing stability, ϕ_R , or the second intersection of the righting lever curve with the wind heeling lever curve, whichever is less, see figure 2.9-1;

A_{HL} = The area below the wind heeling lever curve due to the wind force applied to the ship and the lift at the maximum wind speed specified in paragraph 2.9.4.1.1, see figure 2.9-1.

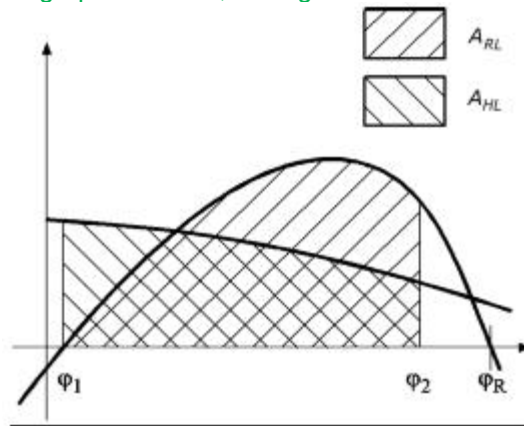

Figure 2.9-1 – Intact criteria under Environmental and Operational limitations
2.9.5 Sudden loss of hook load

2.9.5.1 A ship engaged in a lifting operation and using counter ballasting should be able to withstand the sudden loss of the hook load, considering the most unfavourable point at which the hook load may be applied to the ship (i.e. largest heeling moment). For this purpose, the area on the side of the ship opposite to the lift (Area 2) should be greater than the residual area on the side of the lift (Area 1), as shown in figure 2.9-2, by an amount given by the following:

Area 2 > 1.4 × Area 1, for lifting operations in waters that are exposed.

Area 2 > 1.0 × Area 1, for lifting operations in waters that are not exposed.

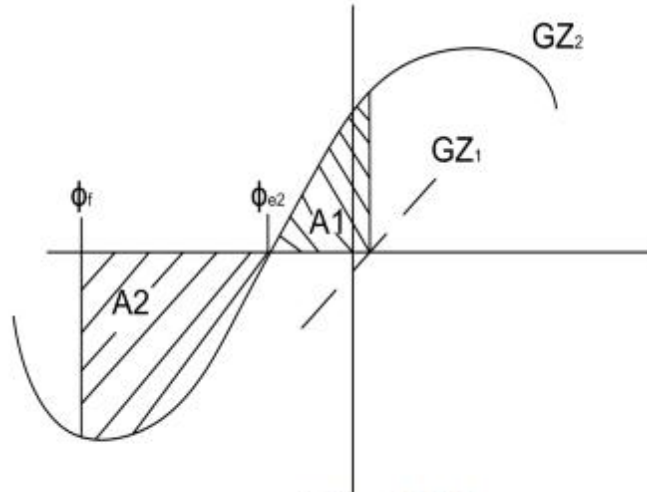

Figure 2.9-2

where:

GZ_1 = net righting lever (GZ) curve for the condition before loss of crane load, corrected for crane heeling moment and for the righting moment provided by the counter ballast if applicable;

GZ_2 = net righting lever (GZ) curve for the condition after loss of crane load, corrected for the transverse moment provided by the counter ballast if applicable;

ϕ_{e2} = the angle of static equilibrium after loss of crane load;

ϕ_f = the angle of down-flooding or the heel angle corresponding to the second intersection between heeling and righting arm curves, whichever is less; and

The term "net righting lever" means that the calculation of the GZ curve includes the ship's true transverse centre of gravity as function of the angle of heel.

2.9.6 Alternative method

2.9.6.1 The criteria in paragraph 2.9.6 may be applied to a ship engaged in a lifting operation, as determined by paragraph 2.9.1, as an alternative to the criteria in paragraph 2.9.3 through paragraph 2.9.5, as applicable. For the purpose of this section and the stability criteria set out in paragraph 2.9.7, the lifted load which causes the ship to heel is translated for the purpose of stability calculation to a heeling moment/heeling lever which is applied on the righting lever curve of the ship.

2.9.6.2 The heeling moment applied to the ship due to a lift and the associated heeling lever should be calculated using the following formulae:

$$HM\varphi = P_L \cdot y \cdot \cos \varphi$$

$$HL\varphi = HM \varphi \div \Delta$$

where:

$HM\varphi$	=	the heeling moment, in (t.m), due to the lift at φ ;
P_L	=	the vertical load, in (t), of the lift, as defined in 2.9.2.1.1;
y	=	the transverse distance, in (m), of the lift, metres, as defined in 2.9.2.1.2;
φ	=	the angle of heel;
$HL\varphi$	=	the heeling lever, in (m) due to the lift at φ ; and
Δ	=	the displacement, in (t) of the ship with the load of the lift.

2.9.6.3 For application of the criteria contained in paragraph 2.9.7 involving the sudden loss of load of the lift in which counter-ballast is used, the heeling levers that include the counter-ballast should be calculated using the following formulae:

$$CHL_1 = \frac{(P_L \cdot y - CBM) \cdot \cos \varphi}{\Delta}$$

$$CBHL_2 = \frac{CBM \cdot \cos \varphi}{(\Delta - PL)}$$

where:

CBM	=	the heeling moment, in (t.m), due to the counter-ballast;
CHL_1	=	combined heeling lever, in (m), due to the load of the lift and the counter-ballast heeling moment at the displacement corresponding to the ship with the load of the lift; and
$CBHL_2$	=	heeling lever, in (m), due to the counter-ballast heeling moment at the displacement corresponding to the ship without the load of the lift.

2.9.6.4 The equilibrium heel angle φ_e referred to in 2.9.7 means the angle of first intersection between the righting lever curve and the heeling lever curve.

2.9.7 Alternative stability criteria

2.9.7.1 For the loading conditions intended for lifting, but before commencing the operation, the stability criteria given in sections 2.2 and 2.3 of part A should be complied with. Where a ship's characteristics render compliance with section 2.2 of part A impracticable, the equivalent stability criteria given in chapter 4 of the explanatory notes to the 2008 IS Code should apply. During the lifting operation, as determined by paragraph 2.9.1, the following stability criteria should apply:

- .1 the residual righting area below the righting lever and above the heeling lever curve between ϕ_e and the lesser of 40° or the angle of the maximum residual righting lever should not be less than:
 - 0.080 m rad, if lifting operations are performed in waters that are exposed; or
 - 0.053 m rad, if lifting operations are performed in waters that are not exposed;
- .2 in addition, the equilibrium angle is to be limited to the lesser of the following:
 - .1 10 degrees;
 - .2 the angle of immersion of the highest continuous deck enclosing the watertight hull; or
 - .3 the lifting appliance allowable value of trim/heel (data to be derived from sidelead and offlead allowable values obtained from manufacturer).

2.9.7.2 A ship engaged in a lifting operation and using counter ballasting should be able to withstand the sudden loss of the hook load, considering the most unfavourable point at which the hook load may be applied to the ship (i.e. largest heeling moment). For this purpose, the area on the side of the ship opposite from the lift (Area 2) in figure 2.9-3 should be greater than the residual area on the side of the lift (Area 1) in figure 2.9-3 by an amount given by the following:

Area 2 – Area 1 > K,

where:

- K = 0.037 m rad, for a lifting operation in waters that are exposed; and
- K = 0.0 m rad, for a lifting operation in waters that are not exposed.

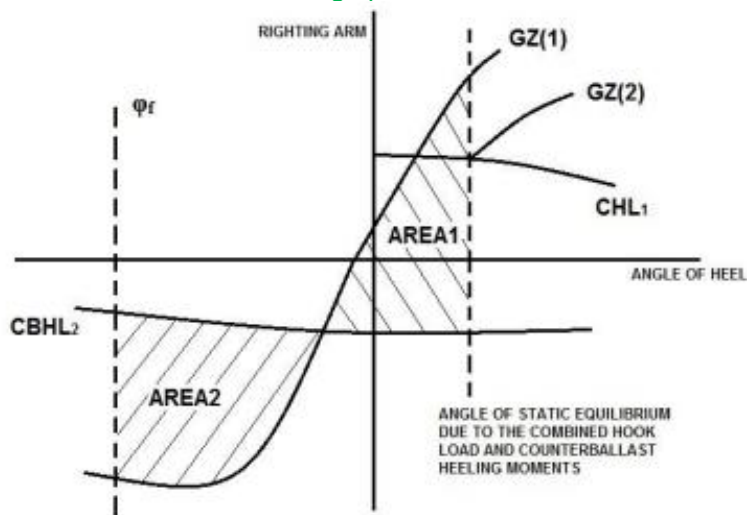

Figure 2.9-3

GZ(1) = The righting arm curve at the displacement corresponding to the ship

without hook load;

GZ(2) = The righting arm curve at the displacement corresponding to the ship with hook load;

Area2 = residual area between GZ(1) and CBHL2 up to the lesser of the down-flooding angle or the second intersection of GZ(2) and CBHL2;

Area1 = residual area below GZ(1) and above CBHL2 up to ϕ_e .

2.9.8 Model tests or direct calculations

2.9.8.1 Model tests or direct calculations, performed in accordance with a methodology acceptable to the Administration, that demonstrate the survivability of the ship after sudden loss of hook load, may be allowed as an alternative to complying with the requirements of paragraph 2.9.5 or 2.9.7.2, provided that:

- .1 the effects of wind and waves are taken into account; and
- .2 the maximum dynamic roll amplitude of the ship after loss of load will not cause immersion of unprotected openings.

2.9.9 Operational procedures against capsizing

2.9.9.1 Ships should avoid resonant roll conditions when engaged in lifting operations.

Note: all the amendments highlighted above are from MSC.415(97) and enter into force 1 January 2020

Part B Chapter 3 - Guidance in preparing stability information**3.1 Effect of free surfaces of liquids in tanks**

3.1.1 For all loading conditions, the initial metacentric height and the righting lever curve should be corrected for the effect of free surfaces of liquids in tanks.

3.1.2 Free surface effects should be considered whenever the filling level in a tank is less than 98% of full condition. Free surface effects need not be considered where a tank is nominally full, i.e. filling level is 98% or above. Free surface effects for small tanks may be ignored under condition specified in 3.1.12.¹⁴

But nominally full cargo tanks should be corrected for free surface effects at 98% filling level. In doing so, the correction to initial metacentric height should be based on the inertia moment of liquid surface at 5° of heeling angle divided by displacement, and the correction to righting lever is suggested to be on the basis of real shifting moment of cargo liquids.

3.1.3 Tanks which are taken into consideration when determining the free surface correction may be in one of two categories:

- .1 tanks with filling levels fixed (e.g., liquid cargo, water ballast). The free surface correction should be defined for the actual filling level to be used in each tank; or
- .2 tanks with filling levels variable (e.g., consumable liquids such as fuel oil, diesel oil and fresh water, and also liquid cargo and water ballast during liquid transfer operations). Except as permitted in 3.1.5 and 3.1.6, the free surface correction should be the maximum value attainable between the filling limits envisaged for each tank, consistent with any operating instructions.

3.1.4 In calculating the free surface effects in tanks containing consumable liquids, it should be assumed that for each type of liquid at least one transverse pair or a single centreline tank has a free surface and the tank or combination of tanks taken into account should be those where the effect of free surfaces is the greatest.

3.1.5 Where water ballast tanks, including anti-rolling tanks and anti-heeling tanks, are to be filled or discharged during the course of a voyage, the free surface effects should be calculated to take account of the most onerous transitory stage relating to such operations.

3.1.6 For ships engaged in liquid transfer operations, the free surface corrections at any stage¹⁵ of the liquid transfer operations may be determined in accordance with the filling level in each tank at that stage of the transfer operation.

3.1.7 The corrections to the initial metacentric height and to the righting lever curve should be addressed separately as follows.

¹⁴ Refer to the intact stability design criteria, contained in MARPOL regulation I/27, together with the associated Unified Interpretation 45.

¹⁵ A sufficient number of loading conditions representing the initial, intermediate and final stages of the filling or discharge operation using the free surface correction at the filling level in each tank at the considered stage may be evaluated to fulfil this recommendation.

3.1.8 In determining the correction to initial metacentric height, the transverse moments of inertia

of the tanks should be calculated at 0° angle of heel according to the categories indicated in 3.1.3.

3.1.9 The righting lever curve may be corrected by any of the following methods subject to the agreement of the [MCA](#):

- .1 correction based on the actual moment of fluid transfer for each angle of heel calculated; or
- .2 correction based on the moment of inertia, calculated at 0° angle of heel, modified at each angle of heel calculated.

3.1.10 Corrections may be calculated according to the categories indicated in 3.1.2.

3.1.11 Whichever method is selected for correcting the righting lever curve, only that method should be presented in the ship's stability booklet. However, where an alternative method is described for use in manually calculated loading conditions, an explanation of the differences which may be found in the results, as well as an example correction for each alternative, should be included.

3.1.12 Small tanks which satisfy the following condition corresponding to an angle of inclination of 30°, need not be included in the correction:

$$M_{fs} / \Delta_{min} < 0.01 \text{ m}$$

where:

M_{fs} free surface moment (mt)

Δ_{min} is the minimum ship displacement calculated at d_{min} (t)

d_{min} is the minimum mean service draught of the ship without cargo, with 10% stores and minimum water ballast, if required (m).

3.1.13 The usual remainder of liquids in empty tanks need not be taken into account in calculating the corrections, provided that the total of such residual liquids does not constitute a significant free surface effect.

3.2 Permanent ballast

If used, permanent ballast should be located in accordance with a plan approved by the [MCA](#) and in a manner that prevents shifting of position. Permanent ballast should not be removed from the ship or relocated within the ship without the approval of the [MCA](#). Permanent ballast particulars should be noted in the ship's stability booklet.

3.3 Assessment of compliance with stability criteria¹⁶

3.3.1 Except as otherwise required by this Code, for the purpose of assessing in general whether the stability criteria are met, stability curves using the assumptions given in this Code should be drawn for the loading conditions intended by the owner in respect of the ship's operations.

3.3.2 If the owner of the ship does not supply sufficiently detailed information regarding such loading conditions, calculations should be made for the standard loading conditions.

3.4 Standard conditions of loading to be examined

3.4.1 Loading conditions

The standard loading conditions referred to in the text of the present Code are as follows.

3.4.1.1 For a passenger ship:

- .1 ship in the fully loaded departure condition with cargo, full stores and fuel and with the full number of passengers with their luggage;
- .2 ship in the fully loaded arrival condition, with cargo, the full number of passengers and their luggage but with only 10% stores and fuel remaining;
- .3 ship without cargo, but with full stores and fuel and the full number of passengers and their luggage; and
- .4 ship in the same condition as at 0 above with only 10% stores and fuel remaining.

3.4.1.2 For a cargo ship:

- .1 ship in the fully loaded departure condition, with cargo homogeneously distributed throughout all cargo spaces and with full stores and fuel;
- .2 ship in the fully loaded arrival condition with cargo homogeneously distributed throughout all cargo spaces and with 10% stores and fuel remaining;
- .3 ship in ballast in the departure condition, without cargo but with full stores and fuel; and
- .4 ship in ballast in the arrival condition, without cargo and with 10% stores and fuel remaining

¹⁶ Care should be taken in the assessment of compliance with stability criteria, especially conditions in which liquid transfer operations might be expected or anticipated, to ensure that the stability criteria is met at all stages of the voyage.

3.4.1.3 *For a cargo ship intended to carry deck cargoes:*

- .1 ship in the fully loaded departure condition with cargo homogeneously distributed in the holds and with cargo specified in extension and mass on deck, with full stores and fuel; and
- .2 ship in the fully loaded arrival condition with cargo homogeneously distributed in holds and with a cargo specified in extension and mass on deck, with 10% stores and fuel.

3.4.1.4 *For a ship intended to carry timber deck cargoes:*

The loading conditions which should be considered for ships carrying timber deck cargoes are specified in 3.4.1.3. The stowage of timber deck cargoes should comply with the provisions of chapter 3 of the Code of Safe Practice for Ships Carrying Timber Deck Cargoes, 1991 (resolution A.715(17)).¹⁷

3.4.1.5 *For an offshore supply vessel the standard loading conditions should be as follows:*

- .1 vessel in fully loaded departure condition with cargo distributed below deck and with cargo specified by position and weight on deck, with full stores and fuel, corresponding to the worst service condition in which all the relevant stability criteria are met;
- .2 vessel in fully loaded arrival condition with cargo as specified in 3.4.1.5.1, but with 10% stores and fuel;
- .3 vessel in ballast departure condition, without cargo but with full stores and fuel;
- .4 vessel in ballast arrival condition, without cargo and with 10% stores and fuel remaining; and
- .5 vessel in the worst anticipated operating condition.

3.4.1.6 *For fishing vessels the standard loading conditions referred to in 2.1.1 are as follows¹⁸:*

- .1 departure conditions for the fishing grounds with full fuel, stores, ice, fishing gear, etc.;
- .2 departure from the fishing grounds with full catch and a percentage of stores, fuel, etc., as agreed by the [MCA](#);
- .3 arrival at home port with 10% stores, fuel, etc. remaining and full catch; and
- .4 arrival at home port with 10% stores, fuel, etc. and a minimum catch, which should normally be 20% of full catch but may be up to 40% provided the [MCA](#) is satisfied that operating patterns justify such a value.

¹⁷ Refer to chapter VI of the 1974 SOLAS Convention and to part C of chapter VI of the 1974 SOLAS Convention as amended by resolution MSC.22(59).

¹⁸ Refer to regulation III/7 of the 1993 Torremolinos Protocol.

3.4.1.7 For a ship engaged in an anchor handling operation, the standard loading conditions should be as follows, in addition to the standard loading conditions for a cargo ship in paragraph 3.4.1.2:

- .1 service loading condition at the maximum draught at which anchor handling operations may occur with the heeling levers as defined in paragraph 2.7.2 for the line tension the ship is capable of with a minimum of 67% stores and fuel, in which all the relevant stability criteria as defined in paragraph 2.7.4 are met;
- .2 service loading condition at the minimum draught at which anchor handling operations may occur with the heeling levers as defined in paragraph 2.7.2 for the line tension the ship is capable of with 10% stores and fuel, in which all the relevant stability criteria as defined in paragraph 2.7.4 are met.

3.4.1.8 For a ship engaged in a harbour, coastal or ocean-going towing operation and/or escort operation, the following loading conditions should be included in addition to the standard loading conditions for a cargo ship in paragraph 3.4.1.2:

- .1 maximum operational draught at which towing or escorting operations are carried out, considering full stores and fuel;
- .2 minimum operational draught at which towing or escorting operations are carried out, considering 10% stores and fuel; and
- .3 intermediate condition with 50% stores and fuel.

3.4.1.9 For ships engaged in lifting, loading conditions reflecting the operational limitations of the ship, while engaged in lifting shall be included in the stability booklet. Use of counter ballast, if applicable, shall be clearly documented, and the adequacy of the ship's stability in the event of the sudden loss of the hook load shall be demonstrated.

3.4.1.10 The criteria stated in paragraphs 2.9.3, 2.9.4, 2.9.5 or 2.9.7, as applicable, shall be satisfied for all loading conditions intended for lifting and with the hook load at the most unfavourable positions. For each loading condition, the weight and centre of gravity of the load being lifted, the lifting appliance, and counter ballast, if any, should be included. The most unfavourable position may be obtained from the load chart and is chosen at the position where the total of the transverse and vertical moment is the greatest. Additional loading conditions corresponding to various boom positions and counter ballast with different filling level (if applicable) may need to be checked.

Note: the amendments highlighted above and in 3.4.2.3 below are from MSC.415(97) and enter into force 1st January 2020

3.4.2 Assumptions for calculating loading conditions

3.4.2.1 For the fully loaded conditions mentioned in 3.4.1.2.1, 3.4.1.2.2, 3.4.1.3.1 and 3.4.1.3.2 if a dry cargo ship has tanks for liquid cargo, the effective deadweight in the loading conditions therein described should be distributed according to two assumptions, i.e. with cargo tanks full, and with cargo tanks empty.

3.4.2.2 In the conditions mentioned in 3.4.1.1.1, 3.4.1.2.1 and 3.4.1.3.1 it should be assumed that the ship is loaded to its subdivision load line or summer load line or if intended to carry a timber deck cargo, to the summer timber load line with water ballast tanks empty.

The MCA accepts the following unified interpretation shown in MSC.1/Circ. 1537/Rev.1 dated 4 July 2019: -

For tankers assigned with a tropical load line, the ship should be assumed to be loaded in accordance with the following:

- .1 a fully loaded departure condition at the tropical load line and the corresponding arrival loading condition are considered;
- .2 the cargo is homogeneously distributed throughout all the cargo tanks; and
- .3 sea water density is 1.025 t/m³.

3.4.2.3 If in any loading condition water ballast is necessary, additional diagrams should be calculated taking into account the water ballast. Its quantity and disposition should be stated. *If a ship operates in zones where ice accretion is likely to occur, allowance for icing should be made in accordance with the provisions of chapter 6 (Icing considerations).*

3.4.2.4 In all cases, the cargo in holds is assumed to be fully homogeneous unless this condition is inconsistent with the practical service of the ship.

3.4.2.5 In all cases, when deck cargo is carried, a realistic stowage mass should be assumed and stated, including the height of the cargo.

3.4.2.6 Considering timber deck cargo the following assumptions are to be made for calculating the loading conditions referred to in 3.4.1.4:

- .1 the amount of cargo and ballast should correspond to the worst service condition in which all the relevant stability criteria of part A 2.2 or the optional criteria given in part A 3.3.2, are met. In the arrival condition, it should be assumed that the weight of the deck cargo has increased by 10% owing to water absorption.

3.4.2.7 For offshore supply vessels the assumptions for calculating loading conditions should be as follows:

- .1 if a vessel is fitted with cargo tanks, the fully loaded conditions of 3.4.1.5.1 and 3.4.1.5.2 should be modified, assuming first the cargo tanks full and then the cargo tanks empty;
- .2 if in any loading condition water ballast is necessary, additional diagrams should be calculated, taking into account the water ballast, the quantity and disposition of which should be stated in the stability information;
- .3 in all cases when deck cargo is carried a realistic stowage weight should be assumed and stated in the stability information, including the height of the cargo and its centre of gravity;
- .4 where pipes are carried on deck, a quantity of trapped water equal to a certain percentage of the net volume of the pipe deck cargo should be assumed in and around the pipes. The net volume should be taken as the internal volume of the pipes, plus the volume between the pipes. This percentage should be 30 if the freeboard amidships is equal to or less than 0.015 L and 10 if the freeboard amidships is equal to or greater than 0.03 L. For intermediate values of the freeboard amidships the percentage may be obtained by linear interpolation. In assessing the quantity of trapped water, the MCA may take into account positive or negative sheer aft, actual trim and area of operation; or
- .5 if a vessel operates in zones where ice accretion is likely to occur, allowance for icing should be made in accordance with the provisions of chapter 6 (Icing considerations).

3.4.2.8 For fishing vessels the assumptions for calculating loading conditions should be as follows:

- .1 allowance should be made for the weight of the wet fishing nets and tackle, etc., on deck;
- .2 allowance for icing, where this is anticipated to occur, should be made in accordance with the provisions of 6.3;
- .3 in all cases the cargo should be assumed to be homogeneous unless this is inconsistent with practice;
- .4 in conditions referred to in 3.4.1.6.2 and 3.4.1.6.3 deck cargo should be included if such a practice is anticipated;
- .5 water ballast should normally only be included if carried in tanks which are specially provided for this purpose.

3.4.2.9 For ships engaged in harbour, coastal or ocean going towing, escort towing, anchor handling or lifting operations, allowance should be made for the anticipated weight of cargo on and below deck, chain in lockers, anticipated type of wire or rope on storage reels and wire on the winches when calculating loading conditions.

3.4.2.10 For ships engaged in anchor handling operations, the compliance with the relevant stability criteria should be made for each set of towing pins and its associated permissible line tensions, including any physical element or arrangement that can restrict the line movement.

3.4.2.11 For ships engaged in anchor handling operations, the reference loading conditions in paragraph 3.4.1.8 should meet the stability criteria in paragraph 2.7.4 when applying the design tension F_d , for the tow pin set nearest to centreline, as a minimum for the lowest α equal to 5 degrees.

Note: the amendments highlighted are from MSC.415(97) and enter into force 1 January 2020

3.5 Calculation of stability curves

3.5.1 General

Hydrostatic and stability curves should be prepared for the trim range of operating loading conditions taking into account the change in trim due to heel (free trim hydrostatic calculation). The calculations should take into account the volume to the upper surface of the deck sheathing. Furthermore, appendages and sea chests need to be considered when calculating hydrostatics and cross curves of stability. In the presence of port-starboard asymmetry, the most unfavourable righting lever curve should be used.

3.5.2 Superstructures, deckhouses, etc., which may be taken into account

3.5.2.1 Enclosed superstructures complying with regulation 3(10)(b) of the 1966 Load Line Convention and 1988 Protocol as amended may be taken into account.

3.5.2.2 Additional tiers of similarly enclosed superstructures may also be taken into account. As guidance windows (pane and frame) that are considered without deadlights in additional tiers above the second tier if considered buoyant should be designed with strength to sustain a safety margin¹⁹

with regard to the required strength of the surrounding structure.²⁰

3.5.2.3 Deckhouses on the freeboard deck may be taken into account, provided that they comply with the conditions for enclosed superstructures laid down in regulation 3(10)(b) of the 1966 Load Line Convention and 1988 Protocol relating thereto, as amended.

3.5.2.4 Where deckhouses comply with the above conditions, except that no additional exit is provided to a deck above, such deckhouses should not be taken into account; however, any deck

3.5.2.5 Deckhouses, the doors of which do not comply with the requirements of regulation 12 of the 1966 Load Line Convention and 1988 Protocol as amended should not be taken into account; however, any deck openings inside the deckhouse are regarded as closed where their means of closure comply with the requirements of regulations 15, 17 or 18 of the 1966 Load Line Convention and 1988 Protocol as amended.

3.5.2.6 Deckhouses on decks above the freeboard deck should not be taken into account, but openings within them may be regarded as closed.

3.5.2.7 Superstructures and deckhouses not regarded as enclosed can, however, be taken into account in stability calculations up to the angle at which their openings are flooded (at this angle, the static stability curve should show one or more steps, and in subsequent computations the flooded space should be considered non-existent).

3.5.2.8 In cases where the ship would sink due to flooding through any openings, the stability curve should be cut short at the corresponding angle of flooding and the ship should be considered to have entirely lost its stability.

3.5.2.9 Small openings such as those for passing wires or chains, tackle and anchors, and also holes of scuppers, discharge and sanitary pipes should not be considered as open if they submerge at an angle of inclination more than 30°. If they submerge at an angle of 30° or less, these openings should be assumed open if the MCA considers this to be a source of significant flooding.

3.5.2.10 Trunks may be taken into account. Hatchways may also be taken into account having regard to the effectiveness of their closures.

3.5.3 Calculation of stability curves for ships carrying timber deck cargoes

In addition to the provisions given above, the MCA may allow account to be taken of the buoyancy of the deck cargo assuming that such cargo has a permeability of 25% of the volume occupied by the cargo. Additional curves of stability may be required if the MCA considers it necessary to investigate the influence of different permeabilities and/or assumed effective height of the deck cargo.

¹⁹ As a guidance for Administrations a safety margin of 30% should be applied.

²⁰ IMO guidance for testing these windows is to be developed.

openings inside such deckhouses should be considered as closed even where no means of closure are provided.

3.5.4 Calculation of stability curves for ships engaged in anchor handling operations to which section 2.7 applies

3.5.4.1 Curves (or tables) of the permissible tension as a function of permissible KG (or GM) are

to be provided for the draught (or displacement) and trim values covering the intended anchor handling operations. The curves (or tables) should be developed under the following assumptions:

- .1 the maximum allowable KG from the approved stability booklet;
- .2 information of permissible tension curve or table for each set of towing pins, including any physical element or arrangement that can restrict the line movement as function of the stability limiting curve should be included;
- .3 where desirable, a permissible tension curve or table should be provided for any specific loading condition;
- .4 the draught (or displacement), trim and KG (or GM) to be taken into consideration are those before application of the tension; and
- .5 where tables are provided that divide the operational, cautionary, and stop work zones, referred to in paragraph 3.8.2 ("Green", "Yellow" or "Amber", "Red" colour codes, respectively) the limiting angles associated with physical features of the stern, including the roller, may be used to define the boundaries between the operational and cautionary zones (green/yellow boundary) and the cautionary and stop work zones (yellow/red boundary).

Note: the amendments highlighted are from MSC.415(97) and enter into force 1st January 2020

3.6 Stability booklet

3.6.1 Stability data and associated plans should be drawn up in the working language of the ship and any other language the MCA may require. Reference is also made to the International Safety Management (ISM) Code, adopted by the Organization by resolution A.741(18). All translations of the stability booklet should be approved.

3.6.2 Each ship should be provided with a stability booklet, approved by the MCA, which contains sufficient information to enable the master to operate the ship in compliance with the applicable requirements contained in the Code. The MCA may have additional requirements. On a mobile offshore drilling unit, the stability booklet may be referred to as an operating manual. The stability booklet may include information on longitudinal strength. This Code addresses only the stability-related contents of the booklet.²¹

²¹ Refer to regulation II-1/22 of the 1974 SOLAS Convention, as amended, regulation 10 of the International Convention on Load Lines, 1966 or the Protocol of 1988 as amended, as applicable and regulation III/10 of the 1993 Torremolinos Protocol.

3.6.3 The stability manual for ships engaged in anchor handling operations should contain additional information on:

- .1 maximum bollard pull, winch pull capacity and brake holding force;

- .2 details on the anchor handling arrangement such as location of the fastening point of the wire, type and arrangement of towing pins, stern roller, all points or elements where the tension is applied to the ship;
- .3 identification of critical downflooding openings;
- .4 guidance on the permissible tensions for each mode of operation and for each set of towing pins, including any physical element or arrangement that can restrict the wire movement, as function of all relevant stability criteria; and
- .5 recommendations on the use of roll reduction systems.

3.6.4 The stability booklet for ships engaged in harbour, coastal or ocean-going towing operations and/or escort operations should contain additional information on:

- .1 maximum bollard pull;
- .2 details on the towing arrangement, including location and type of the towing point(s), such as towing hook, staple, fairlead or any other point serving that purpose;
- .3 identification of critical down-flooding openings;
- .4 recommendations on the use of roll reduction systems;
- .5 if any wire, etc. is included as part of the lightship weight, clear guidance on the quantity and size should be given;
- .6 maximum and minimum draught for towing and escort operations;
- .7 instructions on the use of the quick-release device; and
- .8 for ships engaged in escort operations, the following additional operating information should be included:
 - .1 a table with permissible limits of the heel angle in accordance with the criteria included in paragraph 2.7.3.4 as function of loading condition and escort speed; and
 - .2 instructions on the available means to limit the heel angle within the permissible limits.

3.6.5 For ships engaged in lifting operations, for which section 2.9 applies, additional documentation should be included in the stability booklet:

- .1 maximum heeling moment for each direction of lift/inclination as a function of the counterballast heeling moment, if used, the draught, and vertical centre of gravity;
- .2 where fixed counter ballast is used, the following information should be included:
 - .1 weight of the fixed counter ballast; and
 - .2 centre of gravity (LCG, TCG, VCG) of the fixed counter ballast;
- .3 loading conditions over the range of draughts for which lifting operations

- may be conducted with the maximum vertical load of the lift. Where applicable, righting lever curves for both before and after load drop should be presented for each loading condition;
- .4 limitations on crane operation, including permissible heeling angles, if provided;
 - .5 operational limitations, such as:
 - .1 Maximum Safe Working Load (SWL);
 - .2 maximum radius of operation of all derricks and lifting appliances;
 - .3 maximum load moment; and
 - .4 environmental condition affecting the stability of the ship;
 - .6 instructions related to normal crane operation, including those for use of counter ballast;
 - .7 instructions such as ballasting/de-ballasting procedures to righting the ship following an accidental load drop;
 - .8 identification of critical down-flooding openings;
 - .9 recommendations on the use of roll reduction systems;
 - .10 drawing of the crane showing the weight and centre of gravity, including heel/trim limitations established by the crane manufacturer;
 - .11 a crane load chart, with appropriate de-ratings for wave height;
 - .12 load chart for lifting operations covering the range of operational draughts related to lifting and including a summary of the stability results;
 - .13 a crane specification manual provided by the manufacturer shall be submitted separately for information;
 - .14 the lifting appliance load, radius, boom angle limit table, including identification of offlead and sidelead angle limits and slewing angle range limits and reference to the ship's centreline;
 - .15 a table that relates the ship trim and heel to the load, radius, slewing angle and limits, and the offlead and sidelead limits;
 - .16 procedures for calculating the offlead and sidelead angles and the ship VCG with the load applied;
 - .17 if installed, data associated with a Load Moment Indicator system and metrics included in the system;
 - .18 if lifting appliance (crane) offlead and sidelead determine the maximum ship equilibrium angle, the stability booklet should include a note identifying the lifting appliance as the stability limiting factor during lifting operations; and
 - .19 information regarding the deployment of (stability) pontoons to assist a lifting operation, if fitted.

The information in subparagraphs .2 to .19 above may be included in other ship specific documentation on board the ship. In that case, a reference to these documents shall be included in the stability booklet.

3.6.6 For ships carrying timber deck cargoes:

- .1 comprehensive stability information should be supplied which takes into account timber deck cargo. Such information should enable the master, rapidly and simply, to obtain accurate guidance as to the stability of the ship under varying conditions of service. Comprehensive rolling period tables or diagrams have proved to be very useful aids in verifying the actual stability conditions;²²
- .2 the MCA may deem it necessary that the master be given information setting out the changes in deck cargo from that shown in the loading conditions, when the permeability of the deck cargo is significantly different from 25% (refer to 3.5.3); and

²² Refer to regulation II-1/22 of the 1974 SOLAS Convention, as amended, and regulation 10(2) of the International Convention on Load Lines, 1966 or the Protocol of 1988 as amended, as applicable.

- .3 conditions should be shown indicating the maximum permissible amount of deck cargo having regard to the lightest stowage rate likely to be met in service.

3.6.7 The format of the stability booklet and the information included will vary dependent on the ship type and operation. In developing the stability booklet, consideration should be given to including the following information²³ :

- .1 a general description of the ship;
- .2 instructions on the use of the booklet;
- .3 general arrangement plans showing watertight compartments, closures, vents, downflooding angles, permanent ballast, allowable deck loadings and freeboard diagrams;
- .4 hydrostatic curves or tables and cross curves of stability calculated on a free-trimming basis, for the ranges of displacement and trim anticipated in normal operating conditions;
- .5 capacity plan or tables showing capacities and centre of gravity for each cargo stowage space;
- .6 tank sounding tables showing capacities, centre of gravity, and free surface data for each tank;

²³ Refer to Model Loading and Stability Manual (MSC/Circ.920).

- .7 information on loading restrictions, such as maximum KG or minimum GM curve or table that can be used to determine compliance with the applicable stability criteria;
- .8 standard operating conditions and examples for developing other acceptable

- loading conditions using the information contained in the stability booklet;
- .9 a brief description of the stability calculations done including assumptions;
- .10 general precautions for preventing unintentional flooding;
- .11 information concerning the use of any special cross-flooding fittings with descriptions of damage conditions which may require cross-flooding;
- .12 any other necessary guidance for the safe operation of the ship under normal and emergency conditions;
- .13 a table of contents and index for each booklet;
- .14 inclining test report for the ship, or:
 - .14.1 where the stability data is based on a sister ship, the inclining test report of that sister ship along with the lightship measurement report for the ship in question; or
 - .14.2 where lightship particulars are determined by other methods than from inclining of the ship or its sister, a summary of the method used to determine those particulars;
- .15 recommendation for determination of ship's stability by means of an in-service inclining test.

3.6.8 As an alternative to the stability booklet mentioned in 3.6.1, a simplified booklet in an approved form containing sufficient information to enable the master to operate the ship in compliance with the applicable provisions of the Code as may be provided at the discretion of the [MCA](#).

3.7 Operational measures for ships carrying timber deck cargoes

3.7.1 The stability of the ship at all times, including during the process of loading and unloading timber deck cargo, should be positive and to a standard acceptable to the [MCA](#). It should be calculated having regard to:

- .1 the increased weight of the timber deck cargo due to:
 - .1.1 absorption of water in dried or seasoned timber, and
 - .1.2 ice accretion, if applicable (chapter 6 (Icing considerations));
- .2 variations in consumables;
- .3 the free surface effect of liquid in tanks; and
- .4 weight of water trapped in broken spaces within the timber deck cargo and especially logs.

3.7.2 The master should:

- .1 cease all loading operations if a list develops for which there is no satisfactory explanation and it would be imprudent to continue loading;

- .2 before proceeding to sea, ensure that:
 - .2.1 the ship is upright;
 - .2.2 the ship has an adequate metacentric height; and
 - .2.3 the ship meets the required stability criteria.

3.7.3 The masters of ships having a length less than 100 m should also:

- .1 exercise good judgment to ensure that a ship which carries stowed logs on deck has sufficient additional buoyancy so as to avoid overloading and loss of stability at sea;
- .2 be aware that the calculated GM_0 in the departure condition may decrease continuously owing to water absorption by the deck cargo of logs, consumption of fuel, water and stores and ensure that the ship has adequate GM_0 throughout the voyage; and
- .3 be aware that ballasting after departure may cause the ship's operating draught to exceed the timber load line. Ballasting and de-ballasting should be carried out in accordance with the guidance provided in the Code of Safe Practice for Ships Carrying Timber Deck Cargoes, 1991 (resolution A.715(17)).

3.7.4 Ships carrying timber deck cargoes should operate, as far as possible, with a safe margin of stability and with a metacentric height which is consistent with safety requirements but such metacentric height should not be allowed to fall below the recommended minimum, as specified in part A, 3.3.2.

3.7.5 However, excessive initial stability should be avoided as it will result in rapid and violent motion in heavy seas which will impose large sliding and racking forces on the cargo causing high stresses on the lashings. Operational experience indicates that metacentric height should preferably not exceed 3% of the breadth in order to prevent excessive accelerations in rolling provided that the relevant stability criteria given in part A, 3.3.2 are satisfied. This recommendation may not apply to all ships and the master should take into consideration the stability information obtained from the ship's stability booklet.

3.8 Operational and planning manuals for ships engaged in anchor handling for which section 2.7 applies:

3.8.1 To assist the master an operational and planning manual containing guidelines for planning and performing specific operations should be provided on board. The guidelines should contain sufficient information to enable the master to plan and operate the ship in compliance with the applicable requirements contained in this Code. The following information should be included as appropriate:

- .1 anchor handling arrangements, including:
 - detail arrangement of anchor handling deck equipment (winches, wire stoppers, towing pins, etc.);
 - typical arrangement of cargo on deck (anchors, wires, chain cables, etc.);
 - chain lockers used for mooring deployment;

- anchor handling/towing winch;
 - tugger winches;
 - stern roller, including lateral limits on both ends;
 - lifting appliances, if any and if forming a physical restriction as per paragraph 3.4.2.10; and
 - typical paths of wires between winches and stern roller, showing the limit sectors; and
- .2 detailed data of the permissible tensions, stability limiting curves, and recommendations for calculating ship's loading conditions including sample calculations.

3.8.2 An operation plan should be agreed to by the master of the ship and a copy archived on a remote location before the operation commences. Guidelines and procedures to define a step-wise operational plan for a specific operation should contain instructions for:

- .1 identifying and calculating loading conditions for all relevant stages of operation, taking into account the expected fuel and stores consumption, alterations on deck load, effects of deployment or recovering of the wire on the winches and chain lockers;
- .2 planning ballast operations;
- .3 defining the most favourable consumption sequence and identifying the most onerous situations;
- .4 identifying the possibility or prohibition of using the roll reduction systems in all operational stages;
- .5 operation with open chain lockers, e.g. additional loading conditions for asymmetric filling or other measures to reduce the possibility of flooding;
- .6 collect updated weather forecasts, and to define environmental conditions for anchor handling operations;
- .7 the use of limiting stability curves and intended tensions;
- .8 defining the stop work limits:
 - a permissible tensions and operational sectors for α ;
 - .b heeling angles in compliance with the stability criteria; and
 - .c environmental conditions;
- .9 implement and define corrective and emergency procedures;
- .10 define:
 - .a an operational zone in which normal operations up to the permissible tension are to occur (i.e. a "Green" zone);

- .b a cautionary zone (i.e. a "Yellow" or "Amber" zone) where operations may be reduced or halted to assess the ship's options to return to the operational or Green Zone: the cautionary zone should be not less than an angle of 10 degrees unless table 3.8.3 provides otherwise; and
 - .c a "Stop work" zone (i.e. a "Red" zone) in which the operation should be stopped, for which, in normal operations, the yellow/red boundary should not exceed 45 degrees or the point at which the wire rises above the deck. Notwithstanding this, due consideration may be given to different operations from typical anchor handling operations where the planned operation ensures the safety of the ship; and
- .11 examples of presentation of permissible tensions are presented in annex 3 to part B.

3.8.3 To aid the definition of permissible tensions and zones based on the availability of tension monitoring and an onboard stability instrument the following table is provided.

Table 3.8.3

Availability of Tension Monitoring and an onboard Stability Instrument	Tension monitoring is not available	Tension monitoring is available but no stability instrument is available	Both tension monitoring and a stability instrument is available
Permissible tension, F_p	Design Maximum Line Tension, F_p , in the operational zone.	F_p as described in Stability Booklet, the operational planning guidelines, or the specific operational plan.	F_p as calculated by the stability Instrument for the actual loading condition.
Permissible table	First α should be 5° . The only permissible tension is the Design maximum wire tension, F_d . Figures in the table will be F_d for α for which $F_p \geq F_d$. The cautionary zone would include positions where $F_d > F_p \geq$ maximum winch wire pull. The stop work zone is every other position where $F_p <$ the maximum winch wire pull. If criteria are not fulfilled at $\alpha = 5^\circ$ anchor handling should not be performed without winch modification	Tables may be prepared for different values of draft, trim, KG or GM, or specific predefined loading conditions. Values in the table should range from $\alpha = 0$ to $\alpha = 90^\circ$. A table should identify F_p at critical points and the table should be provided for each set of towing pins.	Tables or curves provided in the stability booklet may be used where F_p throughout the nonspecific operational zone exceeds the maximum anticipated wire tension; otherwise, tables or curves calculated for the actual loading condition must be developed.

Availability of Tension Monitoring and an onboard Stability Instrument	Tension monitoring is not available	Tension monitoring is available but no stability instrument is available	Both tension monitoring and a stability instrument is available
Zones	<p>The operational zone should be defined as the sector between the two outboard α values for which $F_p \geq F_d$. The cautionary zone should be defined as the sector between the α at which $F_p = F_d$ and α at which $F_p =$ maximum winch wire pull. The stop work zone should cover every other position. The sectors should be documented in the Stability Booklet, operational planning guidelines, or the specific operational plan. The sector diagram may be prepared for multiple loading conditions. If the limiting α is less than 5° anchor handling operations should not be performed without winch modifications.</p>	<p>The zones may be developed based on normal operational practices contained in the operational planning guidelines, e.g. the operational zone on the stern roller, cautionary zone for not more than 15deg past the stern roller and the red zone otherwise or developed for a specific operation where the outboard α values at which $F_p =$ maximum anticipated wire tension minus 10° defines the operational zone, if α is greater than 20°. If this α is less than 20°, the operational zone is defined as the sector between $\frac{1}{2}$ the outboard α values at which $F_p =$ maximum anticipated wire tension. In each case, the cautionary zone is defined between the limit of the operational zone and the α value at which $F_p =$ maximum anticipated wire tension. In each case, the operational zone must be identified for the anticipated wire tension.</p>	<p>The zones may be developed based on normal operational practices contained in the operational planning guidelines, e.g. the operational zone on the stern roller, cautionary zone for not more than 15deg past the stern roller and the red zone otherwise or developed for a specific operation where the outboard α values at which $F_p =$ maximum anticipated wire tension minus 10° defines the operational zone, if α is greater than 20°. If this α is less than 20°, the operational zone is defined as the sector between $\frac{1}{2}$ the outboard α values at which $F_p =$ maximum anticipated wire tension. In each case, the cautionary zone is defined between the limit of the operational zone and the α value at which $F_p =$ maximum anticipated wire tension. In each case, the operational zone must be identified</p>

			for the anticipated wire tension.
--	--	--	-----------------------------------

3.9 Operational and planning booklets for ships engaged in lifting for which section 2.9 applies

3.9.1 An operation plan should be agreed to by the Master of the ship and a copy archived on a remote location before the operation commences. To assist the master an operational and planning booklet containing guidelines for planning and performing specific operations should be provided on board.

3.9.2 The guidelines should contain sufficient information to enable the Master to plan and operate the ship in compliance with the applicable requirements contained in this Code. The following information should be included as appropriate:

- .1 lifting arrangements, capabilities and procedures to operate the lifting systems; and
- .2 detailed data concerning the ship's lifting capability, operational limitations, limitations of cargo capacities, stability limiting curves and recommendations for calculating ship's loading conditions including sample calculations.

3.9.3 Guidelines and procedures to define a step-wise operational plan for a specific operation should contain instructions for:

- .1 identifying and calculating loading conditions for all relevant stages of operation, taking into account the alterations on deck load, effects of deployment or recovering of the line on the winches (in particular for deep water lifting);
- .2 planning ballast or counter ballast operations;
- .3 identifying the possibility to use the roll reduction systems in all operational stages;
- .4 collecting latest weather forecasts in order to define the environmental conditions for the intended lifting operation;
- .5 using limiting stability curves, if applicable;
- .6 defining the stop work limits:
 - .1 heeling angles in compliance with the stability criteria; and
 - .2 environmental conditions; and
- .7 defining and implementing corrective and emergency procedures.

Note: the amendments highlighted above are from MSC.415(97) and enter into force 1st January 2020

3.10 Operating booklets for certain ships

3.10.1 Special purpose ships and novel craft should be provided with additional information in the stability booklet such as design limitations, maximum speed, worst intended weather conditions or other information regarding the handling of the craft that the master needs to operate the ship safely.

3.10.2 For double hull oil tankers of single cargo tank across design, an operation manual for loading and unloading cargo oil should be provided, including operational procedures of loading and unloading cargo oil and detailed data of the initial metacentric height of the oil tanker and that of free surface correction of liquids in cargo oil tanks and ballast tanks during loading and unloading cargo oil (including ballasting and discharging) and cargo oil washing of tanks.²⁴

3.10.3 The stability booklet of ro-ro passenger ships should contain information concerning the importance of securing and maintaining all closures watertight due to the rapid loss of stability which may result when water enters the vehicle deck and the fact that capsize can rapidly follow.

²⁴ Refer to the Guidance on intact stability of existing tankers during liquid transfer operations (MSC/Circ.706 – MEPC/Circ.304).

Part B Chapter 4 – Stability Calculations performed by stability instruments**4.1 Stability instruments**²⁵

A stability instrument installed onboard should cover all stability requirements applicable to the ship. The software is subject to approval by the [MCA](#). Active and passive systems are defined in 4.1.2. These requirements cover passive systems and the off-line operation mode of active systems only.

4.1.1 General

4.1.1.1 The scope of stability calculation software should be in accordance with the approved stability booklet and should at least include all information and perform all calculations or checks as necessary to ensure compliance with the applicable stability requirements.

4.1.1.2 An approved stability instrument is not a substitute for the approved stability booklet, and is used as a supplement to the approved stability booklet to facilitate stability calculations.

4.1.1.3 The input/output information should be easily comparable with the approved stability booklet so as to avoid confusion and possible misinterpretation by the operator.

4.1.1.4 An operation manual is to be provided for the stability instrument.

4.1.1.5 The language in which the stability calculation results are displayed and printed out as well as the operation manual is written should be the same as used in the ship's approved stability booklet. A translation into a language considered appropriate may be required.

4.1.1.6 The stability instrument is ship specific equipment and the results of the calculations are only applicable to the ship for which it has been approved.

4.1.1.7 In case of modifications of the ship which cause alterations in the stability booklet, the specific approval of any original stability calculation software is no longer valid. The software is to be modified accordingly and re-approved.

4.1.1.8 Any change in software version related to the stability calculation should be reported to and be approved by the [MCA](#).

4.1.2 Data entry system

4.1.2.1 A passive system requires manual data entry.

4.1.2.2 An active system replaces partly the manual entry with sensors reading and entering the contents of tanks, etc.

4.1.2.3 Any integrated system which controls or initiates actions based on the sensor-supplied inputs is not within the scope of this Code except the part calculating the stability.

²⁵ Refer to the Guidelines for the approval of stability instruments (MSC.1/Circ.1229).

4.1.3 Types of stability software

Three types of calculations performed by stability software are acceptable depending upon a vessel's stability requirements:

Type 1

Software calculating intact stability only (for vessels not required to meet a damage stability criterion).

Type 2

Software calculating intact stability and checking damage stability on basis of a limit curve (e.g., for vessels applicable to SOLAS part B-1 damage stability calculations, etc.) or previously approved loading conditions.

Type 3

Software calculating intact stability and damage stability by direct application of pre-programmed damage cases for each loading condition (for some tankers etc.). The results of the direct calculations performed by the stability instrument could be accepted by the MCA even if they differ from the required minimum GM or maximum VCG stated in the approved stability booklet.

Such deviations could be accepted under the condition that all relevant stability requirements will be complied with by the results of the direct calculations.

4.1.4 Functional requirements

4.1.4.1 The stability instrument should present relevant parameters of each loading condition in order to assist the master in his judgment on whether the ship is loaded within the approved limits. The following parameters should be presented for a given loading condition:

- .1 detailed deadweight data items including centre of gravity and free surfaces, if applicable;
- .2 trim; list;
- .3 draught at the draught marks and perpendiculars;
- .4 summary of loading condition displacement; VCG; LCG, TCG; VCB, LCB, TCB, LCF, GM and GML;
- .5 table showing the righting lever versus heeling angle including trim and draught;
- .6 down-flooding angle and corresponding down-flooding opening; and
- .7 compliance with stability criteria: Listings of all calculated stability criteria, the limit values, the obtained values and the conclusions (criteria fulfilled or not fulfilled).

4.1.4.2 For ships engaged in anchor handling operations planning tools should be provided in compliance with operational manual requirements. Information such as ballasting and consumables sequences, permissible tension, working sectors, heeling angles and use of roll-reduction devices should be stated.

Note: the amendments highlighted are from MSC.415(97) and enter into force 1st January 2020

4.1.4.3 If direct damage stability calculations are performed, the relevant damage cases according to the applicable rules should be pre-defined for automatic check of a given loading condition.

4.1.4.4 A clear warning should be given on screen and in hard copy printout if any of the limitations are not complied with.

4.1.4.5 The data are to be presented on screen and in hard copy printout in a clear unambiguous manner.

4.1.4.6 The date and time of a saved calculation should be part of the screen display and hard copy printout.

4.1.4.7 Each hard copy printout should contain identification of the calculation program including version number.

4.1.4.8 Units of measurement are to be clearly identified and used consistently within a loading calculation.

4.1.5 Acceptable tolerances

Depending on the type and scope of programs, the acceptable tolerances are to be determined differently, according to 4.1.5.1 or 4.1.5.2. Deviation from these tolerances should not be accepted unless the MCA considers that there is a satisfactory explanation for the difference and that there will be no adverse effect on the safety of the ship.

The accuracy of the results should be determined using an independent program or the approved stability booklet with identical input.

4.1.5.1 Programs which use only pre-programmed data from the approved stability booklet as the basis for stability calculations should have zero tolerances for the printouts of input data.

Output data tolerances are to be close to zero, however, small differences associated with calculation rounding or abridged input data are acceptable. Additionally, differences associated with the use of hydrostatic and stability data for trims and the method calculating free surface moments that differ from those in the approved stability booklet are acceptable subject to review by the MCA.

4.1.5.2 Programs which use hull form models as their basis for stability calculations should have tolerances for the printouts of basic calculated data established against either data from the approved stability booklet or data obtained using the MCA's approval model.

4.1.6 Approval procedure

4.1.6.1 Conditions of approval of the stability instrument

The software approval includes:

- .1 verification of type approval, if any;
- .2 verification that the data used is consistent with the current condition of the ship (refer to paragraph 4.1.6.2);
- .3 verification and approval of the test conditions; and

- .4 verification that the software is appropriate for the type of ship and stability calculations required.

The satisfactory operation of the stability instrument is to be verified by testing upon installation (refer to paragraph 4.1.8). A copy of the approved test conditions and the operation manual for the stability instrument are to be available on board.

4.1.6.2 *Specific approval*

4.1.6.2.1 The accuracy of the computational results and actual ship data used by the calculation program for the particular ship on which the program will be installed should be to the satisfaction of the [MCA](#).

4.1.6.2.2 Upon application for data verification, minimum of four loading conditions should be taken from the ship's approved stability booklet, which are to be used as the test conditions. For ships carrying liquids in bulk, at least one of the conditions should include partially filled tanks. For ships carrying grain in bulk, one of the grain loading conditions should include a partially filled grain compartment. Within the test conditions each compartment should be loaded at least once. The test conditions normally are to cover the range of load draughts from the deepest envisaged loaded condition to the light ballast condition and should include at least one departure and one arrival condition.

4.1.6.2.3 The following data, submitted by the applicant, should be consistent with arrangements and most recently approved lightship characteristics of the ship according to current plans and documentation on file, subject to possible further verification on board:

- .1 identification of the calculation program including version number. Main dimensions, hydrostatic particulars and, if applicable, the ship's profile;
- .2 the position of the forward and aft perpendiculars, and if appropriate, the calculation method to derive the forward and aft draughts at the actual position of the ship's draught marks;
- .3 ship's lightweight and centre of gravity derived from the most recently approved inclining experiment or light weight survey;
- .4 lines plan, offset tables or other suitable presentation of hull form data including all relevant appendages, if necessary to model the ship;
- .5 compartment definitions, including frame spacing, and centres of volume, together with capacity tables (sounding/ullage tables), free surface corrections, if appropriate; and
- .6 cargo and consumables distribution for each loading condition.

Verification by the [MCA](#) does not absolve the ship owner of responsibility for ensuring that the information programmed into the stability instrument is consistent with the current condition of the ship and approved stability booklet.

4.1.7 *User manual*

A simple and straightforward user manual written in the same language as the stability booklet is to be provided, containing descriptions and instructions, as appropriate, for at least the following:

- .1 installation;
- .2 function keys;
- .3 menu displays;
- .4 input and output data;
- .5 required minimum hardware to operate the software;
- .6 use of the test loading conditions;
- .7 computer-guided dialogue steps; and
- .8 list of warnings.

A user manual in electronic format may be provided in addition to the written manual.

4.1.8 *Installation testing*

4.1.8.1 To ensure correct working of the stability instrument after the final or updated software has been installed, it is the responsibility of the ship's master to have test calculations carried out according to the following pattern in the presence of an [MCA](#) surveyor. From the approved test conditions at least one load case (other than light ship) should be calculated.

Note: Actual loading condition results are not suitable for checking the correct working of the stability instrument.

4.1.8.2 Normally, the test conditions are permanently stored in the stability instrument. Steps to be performed:

- .1 retrieve the test load case and start a calculation run; compare the stability results with those in the documentation;
- .2 change several items of deadweight (tank weights and the cargo weight) sufficiently to change the draught or displacement by at least 10%. The results are to be reviewed to ensure that they differ in a logical way from those of the approved test condition;
- .3 revise the above modified load condition to restore the initial test condition and compare the results. The relevant input and output data of the approved test condition are to be replicated; and
- .4 alternatively, one or more test conditions should be selected and the test calculations performed by entering all deadweight data for each selected test condition into the program as if it were a proposed loading. The results should be verified as identical to the results in the approved copy of the test conditions.

4.1.9 Periodical testing

4.1.9.1 It is the responsibility of the ship's master to check the accuracy of the stability instrument at each annual survey by applying at least one approved test condition. If an MCA representative is not present for the stability instrument check, a copy of the test condition results obtained by this check is to be retained on board as documentation of satisfactory testing for the MCA's representative's verification.

4.1.9.2 At each renewal survey this checking for all approved test loading conditions is to be done in the presence of the MCA's representative.

4.1.9.3 The testing procedure should be carried out in accordance with paragraph 4.1.8.

4.1.10 Other requirements

4.1.10.1 Protection against unintentional or unauthorized modification of programs and data should be provided.

4.1.10.2 The program should monitor operation and activate an alarm when the program is incorrectly or abnormally used.

4.1.10.3 The program and any data stored in the system should be protected from corruption by loss of power.

4.1.10.4 Error messages with regard to limitations such as filling a compartment beyond capacity or more than once, or exceeding the assigned load line, etc., should be included.

4.1.10.5 If any software related to stability measures such as sea keeping abilities of the vessel, evaluation of in-service inclining experiments and processing the results for further calculation, as well as the evaluation of roll period measurements is installed on board, such software should be reported to the MCA for consideration.

4.1.10.6 Program functionalities should include mass and moment calculations with numerical and graphical presentation of the results, such as initial stability values, righting lever curve, areas under the righting lever curve and range of stability.

4.1.10.7 All input data from automatically measuring sensors, such as gauging devices or draught reading systems should be presented to the user for verification. The user should have the possibility to override faulty readings manually.

5.1 General precautions against capsizing

5.1.1 Compliance with the stability criteria does not ensure immunity against capsizing, regardless of the circumstances, or absolve the master from his responsibilities. Masters should therefore exercise prudence and good seamanship having regard to the season of the year, weather forecasts and the navigational zone and should take the appropriate action as to speed and course warranted by the prevailing circumstances.²⁶

5.1.2 Care should be taken that the cargo allocated to the ship is capable of being stowed so that compliance with the criteria can be achieved. If necessary, the amount should be limited to the extent that ballast weight may be required.

5.1.3 Before a voyage commences, care should be taken to ensure that the cargo, cargo handling cranes and sizeable pieces of equipment have been properly stowed or lashed so as to minimize the possibility of both longitudinal and lateral shifting, while at sea, under the effect of acceleration caused by rolling and pitching.²⁷

5.1.4 A ship, when engaged in towing operations, should possess an adequate reserve of stability to withstand the anticipated heeling moment arising from the tow line without endangering the towing ship. Deck cargo on board the towing ship should be so positioned as not to endanger the safe working of the crew on deck or impede the proper functioning of the towing equipment and be properly secured. Tow line arrangements should include towing springs and a method of quick release of the tow.

5.1.5 The number of partially filled or slack tanks should be kept to a minimum because of their adverse effect on stability. The negative effect on stability of filled pool tanks should be taken into consideration.

5.1.6 The stability criteria contained in part A chapter 2 set minimum values, but no maximum values are recommended. It is advisable to avoid excessive values of metacentric height, since these might lead to acceleration forces which could be prejudicial to the ship, its complement, its equipment and to safe carriage of the cargo. Slack tanks may, in exceptional cases, be used as a means of reducing excessive values of metacentric height. In such cases, due consideration should be given to sloshing effects.

5.1.7 Regard should be paid to the possible adverse effects on stability where certain bulk cargoes are carried. In this connection, attention should be paid to the IMO Code of Safe Practice for Solid Bulk Cargoes.

5.2 Operational precautions in heavy weather

5.2.1 All doorways and other openings, through which water can enter into the hull or deckhouses, forecastle, etc., should be suitably closed in adverse weather conditions and accordingly all appliances for this purpose should be maintained on board and in good condition.

²⁶ Refer to the Revised Guidance to the master for avoiding dangerous situations in adverse weather and sea conditions (MSC.1/Circ.1228).

²⁷ Refer to the Guidelines for the preparation of the Cargo Securing Manual (MSC/Circ.745).

5.2.2 Weathertight and watertight hatches, doors, etc., should be kept closed during navigation,

except when necessarily opened for the working of the ship and should always be ready for immediate closure and be clearly marked to indicate that these fittings are to be kept closed except for access. Hatch covers and flush deck scuttles in fishing vessels should be kept properly secured when not in use during fishing operations. All portable deadlights should be maintained in good condition and securely closed in bad weather.

5.2.3 Any closing devices provided for vent pipes to fuel tanks should be secured in bad weather.

5.2.4 Fish should never be carried in bulk without first being sure that the portable divisions in the holds are properly installed.

5.3 Ship handling in heavy weather

5.3.1 In all conditions of loading necessary care should be taken to maintain a seaworthy freeboard.

5.3.2 In severe weather, the speed of the ship should be reduced if propeller emergence, shipping of water on deck or heavy slamming occurs.

5.3.3 Special attention should be paid when a ship is sailing in following, quartering or head seas because dangerous phenomena such as parametric resonance, broaching to, reduction of stability on the wave crest, and excessive rolling may occur singularly, in sequence or simultaneously in a multiple combination, creating a threat of capsizing. A ship's speed and/or course should be altered²⁸ appropriately to avoid the above-mentioned phenomena.

5.3.4 Reliance on automatic steering may be dangerous as this prevents ready changes to course which may be needed in bad weather.

5.3.5 Water trapping in deck wells should be avoided. If freeing ports are not sufficient for the drainage of the well, the speed of the ship should be reduced or the course changed, or both. Freeing ports provided with closing appliances should always be capable of functioning and are not to be locked.

5.3.6 Masters should be aware that steep or breaking waves may occur in certain areas, or in certain wind and current combinations (river estuaries, shallow water areas, funnel shaped bays, etc.). These waves are particularly dangerous, especially for small ships.

5.3.7 In severe weather, the lateral wind pressure may cause a considerable angle of heel. If anti-heeling measures (e.g., ballasting, use of anti-heeling devices, etc.) are used to compensate for heeling due to wind, changes of the ship's course relative to the wind direction may lead to dangerous angles of heel or capsizing. Therefore, heeling caused by the wind should not be compensated with anti-heeling measures, unless, subject to the approval by the [MCA](#), the vessel has been proven by calculation to have sufficient stability in worst case conditions (i.e. improper or incorrect use, mechanism failure, unintended course change, etc.). Guidance on the use of anti-heeling measures should be provided in the stability booklet.

²⁸ Refer to the Revised Guidance to the master for avoiding dangerous situations in adverse weather and sea conditions (MSC.1/Circ.1228).

5.3.8 Use of operational guidelines for avoiding dangerous situations in severe weather conditions or an on-board computer based system is recommended. The method should be simple to use.

5.3.9 High-speed craft should not be intentionally operated outside the worst intended conditions and limitations specified in the relevant certificates, or in documents referred to therein.

MCA Note: Special attention shall be paid to MSC.1/Circ.1228, in particular section 4 on Operational Guidance, which contains recommendations to the master on how to handle the ship to avoid dangerous situations when navigating in severe weather conditions, such as: -

- Surf-riding and broaching-to
- Successive high-wave attack
- Synchronous rolling and parametric rolling motions

Consideration should be given to including these recommendations in the trim and stability booklet and/or incorporating them into the on-board computer.

Part B Chapter 6 – Icing Considerations

6.1 General

6.1.1 For any ship operating in areas where ice accretion is likely to occur, adversely affecting a ship's stability, icing allowances should be included in the analysis of conditions of loading.

6.1.2 Administrations are advised to take icing into account and are permitted to apply national standards where environmental conditions are considered to warrant a higher standard than those recommended in the following sections.

6.2 Cargo ships carrying timber deck cargoes

6.2.1 The master should establish or verify the stability of his ship for the worst service condition, having regard to the increased weight of deck cargo due to water absorption and/or ice accretion and to variations in consumables.²⁹

6.2.2 When timber deck cargoes are carried and it is anticipated that some formation of ice will take place, an allowance should be made in the arrival condition for the additional weight.

6.2.3 Allowance for ice accretion

- .1 The ice accretion weight, w (kg/m²), may be taken as follows:

$$w = 30 \cdot \frac{2.3(15.2 L - 351.8)}{l_{FB}} \cdot f_{tl} \cdot \frac{l_{bow}}{0.16 L}$$

where:

f_{tl}	=	timber and lashing factor = 1.2
L	=	length of ship in m
l_{FB}	=	freeboard height in mm
l_{bow}	=	length of bow flare region in m, to be taken as the distance from the longitudinal position at which the maximum breadth occurs on a water line located 0.5 metres below the freeboard deck at side to the foremost point of the bow at that waterline.

- .2 The ice accretion weight, w (kg/m²), over the timber deck region should be applied to each of the load cases as illustrated in figure 1:

MCA Note: Paragraph 6.2.3 and figure 1 below is from IMO Resolution MSC.398(95), which took effect from 5 June 2015

²⁹ Refer to regulation 44(10) of the 1966 Load Line Convention and regulation 44(7) of the 1988 Load Line Protocol as amended.

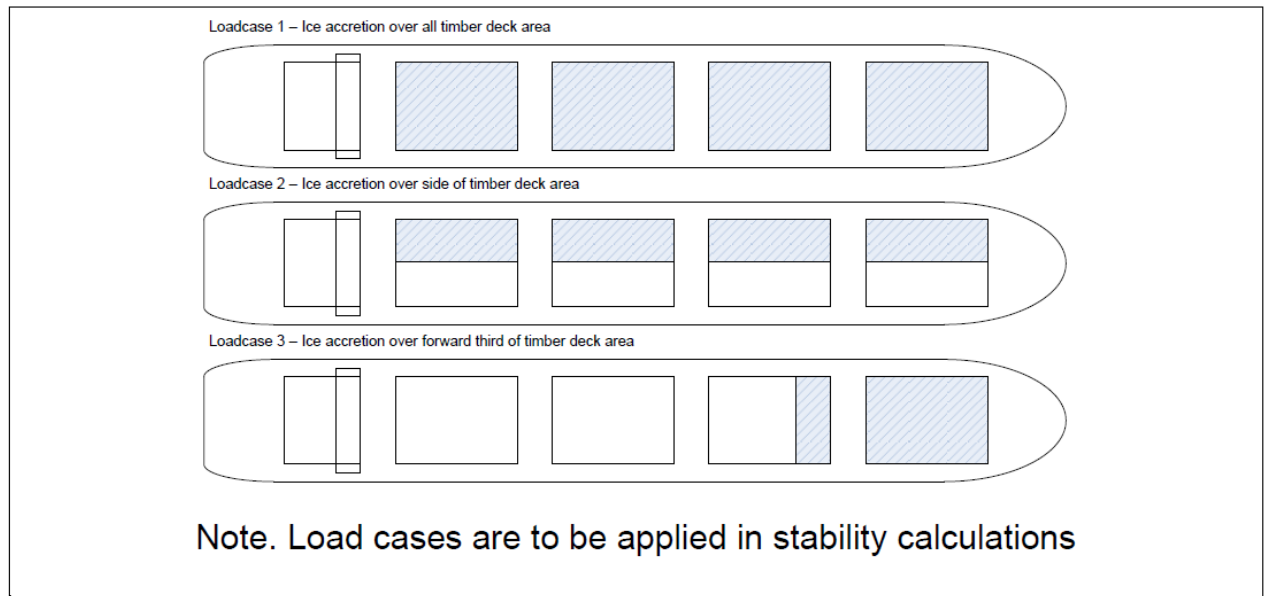

Figure 1 – Ice accretion load cases for timber deck cargoes

6.3 Fishing vessels

The calculations of loading conditions for fishing vessels (refer to 3.4.2.8) should, where appropriate, include allowance for ice accretion, in accordance with the following provisions.

6.3.1 Allowance for ice accretion³⁰

For vessels operating in areas where ice accretion is likely to occur, the following icing allowance should be made in the stability calculations:

- .1 30 kg per square metre on exposed weather decks and gangways;
- .2 7.5 kg per square metre for projected lateral area of each side of the vessel above the water plane;
- .3 the projected lateral area of discontinuous surfaces of rail, sundry booms, spars (except masts) and rigging of vessels having no sails and the projected lateral area of other small objects should be computed by increasing the total projected area of continuous surfaces by 5% and the static moments of this area by 10%.

Vessels intended for operation in areas where ice is known to occur should be:

- .4 designed to minimize the accretion of ice; and
- .5 equipped with such means for removing ice as the MCA may require; for example, electrical and pneumatic devices, and/or special tools such as axes or wooden clubs for removing ice from bulwarks, rails and erections.

³⁰ Refer to regulation III/8 of the 1993 Torremolinos Protocol.

6.3.2 Guidance relating to ice accretion

In the application of the above standards the following icing areas should apply:

- .1 the area north of latitude 65° 30' N, between longitude 28° W and the west coast of Iceland; north of the north coast of Iceland; north of the rhumb line running from latitude 66° N, longitude 15° W to latitude 73° 30' N, longitude 15° E, north of latitude 73° 30' N between longitude 15° E and 35° E, and east of longitude 35° E, as well as north of latitude 56° N in the Baltic Sea;
- .2 the area north of latitude 43° N bounded in the west by the North American coast and the east by the rhumb line running from latitude 43° N, longitude 48° W to latitude 63° N, longitude 28° W and thence along longitude 28° W;
- .3 all sea areas north of the North American Continent, west of the area defined in 6.3.2.1 and 6.3.2.2
- .4 the Bering and Okhotsk Seas and the Tartary Strait during the icing season; and
- .5 south of latitude 60° S.

A chart to illustrate the areas is attached at the end of this chapter.

For vessels operating in areas where ice accretion may be expected:

- .6 within the areas defined in 6.3.2.1, 6.3.2.3, 6.3.2.4 and 6.3.2.5 known to having icing conditions significantly different from those described in 6.3.1, ice accretion requirements of one half to twice the required allowance may be applied; and
- .7 within the area defined in 6.3.2.2, where ice accretion in excess of twice the allowance required by 6.3.1 may be expected, more severe requirements than those given in 6.3.1 may be applied.

6.3.3 Brief survey of the causes of ice formation and its influence upon the seaworthiness of the vessel

6.3.3.1 The skipper of a fishing vessel should bear in mind that ice formation is a complicated process which depends upon meteorological conditions, condition of loading and behaviour of the vessel in stormy weather as well as on the size and location of superstructures and rigging. The most common cause of ice formation is the deposit of water droplets on the vessel's structure. These droplets come from spray driven from wave crests and from ship-generated spray.

6.3.3.2 Ice formation may also occur in conditions of snowfall, sea fog (including arctic sea smoke), a drastic fall in ambient temperature, as well as from the freezing of drops of rain on impact with the vessel's structure.

6.3.3.3 Ice formation may sometimes be caused or accentuated by water shipped on board and retained on deck.

6.3.3.4 Intensive ice formation generally occurs on stem, bulwark and bulwark rail, front walls of superstructures and deck-houses, hawse holes, anchors, deck gear, forecastle deck and upper deck, freeing ports, aerials, stays, shrouds, masts and spars.

6.3.3.5 It should be borne in mind that the most dangerous areas as far as ice formation is concerned are the sub-Arctic regions.

6.3.3.6 The most intensive ice formation takes place when wind and sea come from ahead. In beam and quartering winds, ice accumulates quicker on the windward side of the vessel, thus leading to a constant list which is extremely dangerous.

6.3.3.7 Listed below are meteorological conditions causing the most common type of ice formation due to spraying of a vessel. Examples of the weight of ice formation on a typical fishing vessel of displacement in the range 100 t to 500 t are also given. For larger vessels the weight will be correspondingly greater.

6.3.3.8 Slow accumulations of ice take place:

- .1 at ambient temperature from -1°C to -3°C and any wind force;
- .2 at ambient temperature -4°C and lower and wind force from 0 to 9 m/s; and
- .3 under the conditions of precipitation, fog or sea mist followed by a drastic fall of the ambient temperature.

Under all these conditions the intensity of ice accumulation may not exceed 1.5 t/h.

6.3.3.9 At ambient temperature of -4°C to -8°C and wind force 10 to 15 m/s, rapid accumulation of ice takes place. Under these conditions the intensity of ice accumulation can lie within the range 1.5 to 4 t/h.

6.3.3.10 Very fast accumulation of ice takes place:

- .1 at ambient temperature of -4°C and lower and wind forces of 16 m/s and over; and
- .2 at ambient temperature -9°C and lower and wind force 10 to 15 m/s.

Under these conditions the intensity of ice accumulation can exceed 4 t/h.

6.3.3.11 The skipper should bear in mind that ice formation adversely affects the seaworthiness of the vessel as ice formation leads to:

- .1 an increase in the weight of the vessel due to accumulation of ice on the vessel's surfaces which causes the reduction of freeboard and buoyancy;
- .2 a rise of the vessel's centre of gravity due to the high location of ice on the vessel's structures with corresponding reduction in the level of stability;
- .3 an increase of windage area due to ice formation on the upper parts of the vessel and hence an increase in the heeling moment due to the action of the wind;
- .4 a change of trim due to uneven distribution of ice along the vessel's length;
- .5 the development of a constant list due to uneven distribution of ice across the breadth of the vessel; and
- .6 impairment of the manoeuvrability and reduction of the speed of the vessel.

6.3.4 Operational procedures related to ensuring a fishing vessel's endurance in conditions of ice formation are given in annex 2 (Recommendations for skippers of fishing vessels on ensuring a vessel's endurance in conditions of ice formation).

6.4 Offshore supply vessels 24 m to 100 m in length

For vessels operating in areas where ice accretion is likely to occur:

- .1 no shutters should be fitted in the freeing ports; and
- .2 with regard to operational precautions against capsizing, reference is made to the recommendations for skippers of fishing vessels on ensuring a vessel's endurance in conditions of ice formation, as given in paragraph 6.3.3 and in annex 2 (Recommendations for skippers of fishing vessels on ensuring a vessel's endurance in conditions of ice formation).

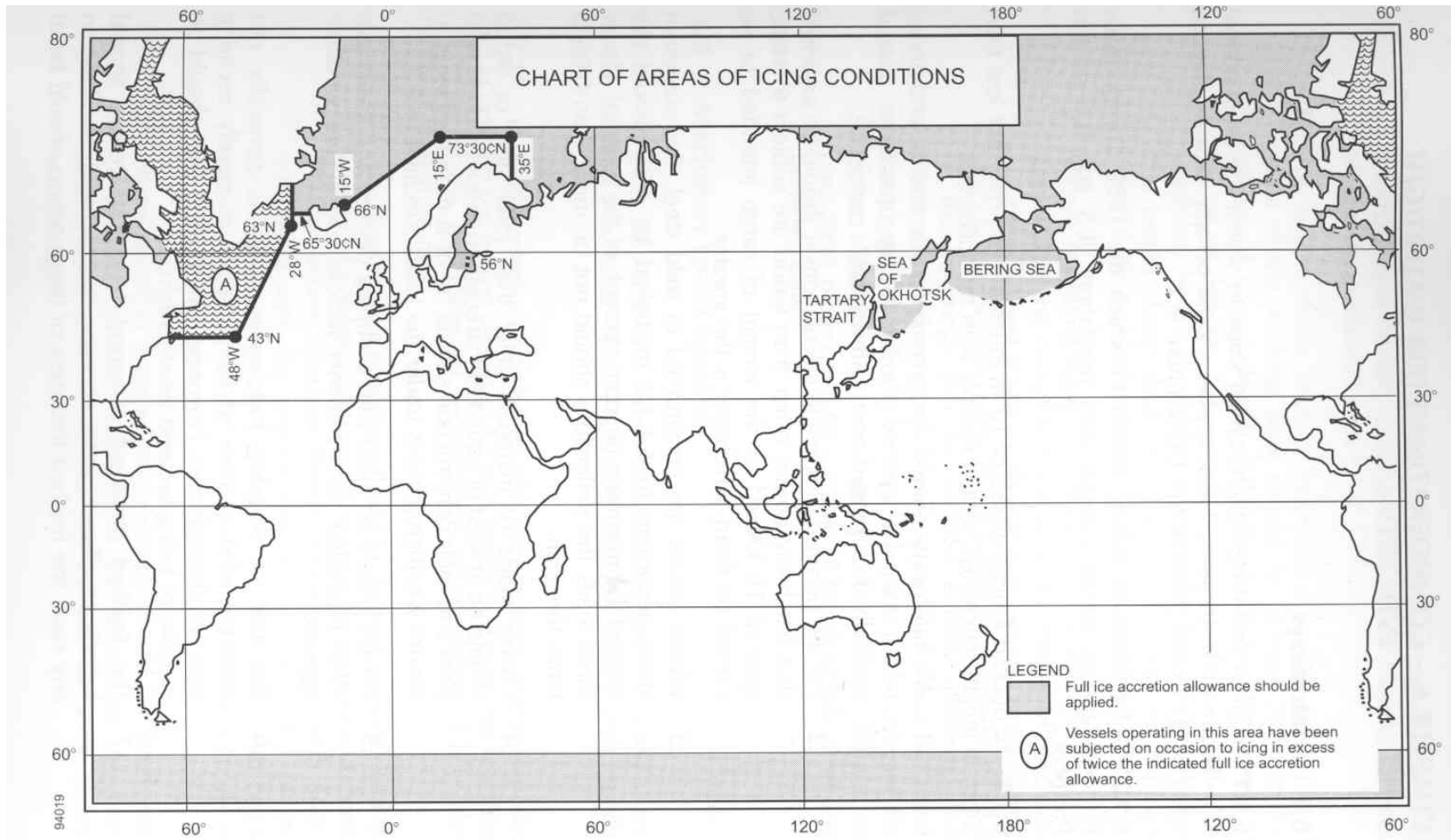

Part B Chapter 7 – Considerations for watertight and weathertight integrity**7.1 Hatchways**

7.1.1 Cargo and other hatchways in ships to which the International Convention on Load Lines, 1966, applies should comply with regulations 13, 14, 15, 16 and 26(5) of this Convention.

7.1.2 Hatchways in fishing vessels to which the 1993 Torremolinos Protocol applies should comply with regulations II/5 and II/6 of this Protocol.

7.1.3 In decked fishing vessels of 12 m in length and over but less than 24 m in length hatchways should comply with the following:

7.1.3.1 All hatchways should be provided with covers and those which may be opened during fishing operations should normally be arranged near to the vessel's centreline.

7.1.3.2 For the purpose of strength calculations it should be assumed that hatchway covers other than wood are subject to static load of 10 kN/m^2 or the weight of cargo intended to be carried on them, whichever is the greater.

7.1.3.3 Where covers are constructed of mild steel, the maximum stress according to 7.1.3.2 multiplied by 4.25 should not exceed the minimum ultimate strength of the material. Under these loads the deflections should not be more than 0.0028 times the span.

7.1.3.4 Covers made of materials other than mild steel or wood should be at least of equivalent strength to those made of mild steel and their construction should be of sufficient stiffness to ensure weathertightness under the loads specified in 7.1.3.2.

7.1.3.5 Covers should be fitted with clamping devices and gaskets or other equivalent arrangements sufficient to ensure weathertightness.

7.1.3.6 The use of wooden hatchway covers is generally not recommended in view of the difficulty of rapidly securing their weathertightness. However, where fitted they should be capable of being secured weathertight.

7.1.3.7 The finished thickness of wood hatchway covers should include an allowance for abrasion due to rough handling. In any case, the finished thickness of these covers should be at least 4 mm for each 100 mm of unsupported span subject to a minimum of 40 mm and the width of their bearing surfaces should be at least 65 mm.

7.1.3.8 The height above deck of hatchway coamings on exposed parts of the working deck should be at least 300 mm for vessels of 12 m in length and at least 600 mm for vessels of 24 m in length. For vessels of intermediate length the minimum height should be obtained by linear interpolation. The height above deck of hatchway coamings on exposed parts of the superstructure deck should be at least 300 mm.

7.1.3.9 Where operating experience has shown justification and on approval of the competent authority the height of hatchway coamings, except those which give direct access to machinery spaces may be reduced from the height as specified in 7.1.3.8 or the coamings may be omitted entirely, provided that efficient watertight hatch covers other than wood are fitted. Such hatchways should be kept as small as practicable and the covers should be permanently attached by hinges or equivalent means and capable of being rapidly closed or battened down.

7.2 Machinery space openings

7.2.1 In ships to which the International Convention on Load Lines, 1966 or the Protocol of 1988 as amended, as applicable, applies machinery space openings should comply with reg. 17.

7.2.2 In fishing vessels to which the 1993 Torremolinos Protocol applies and in new decked fishing vessels of 12 m in length and over, but less than 24 m in length, the following requirements of regulation II/7 of this Protocol should be met:

- .1 machinery space openings should be framed and enclosed by casings of a strength equivalent to the adjacent superstructure. External access openings therein should be fitted with doors complying with the requirements of regulation II/4 of the Protocol or, in vessels less than 24 m in length, with hatch covers other than wood complying with the requirements of 7.1.3 of this chapter; and
- .2 openings other than access openings should be fitted with covers of equivalent strength to the unpierced structure, permanently attached thereto and capable of being closed weathertight.

7.2.3 In offshore supply vessels, access to the machinery space should, if possible, be arranged within the forecastle. Any access to the machinery space from the exposed cargo deck should be provided with two weathertight closures. Access to spaces below the exposed cargo deck should preferably be from a position within or above the superstructure deck.

7.3 Doors

7.3.1 In passenger ships to which the International Convention for the Safety of Life at Sea, 1974, applies, doors should comply with regulations II-I/13 and 16 of this Convention.

7.3.2 In ships to which the International Convention on Load Lines, 1966 or the Protocol of 1988 relating thereto, as amended, as applicable, applies, doors should comply with regulation 12 of this Convention.

7.3.3 In fishing vessels to which the 1993 Torremolinos Protocol applies, doors should comply with regulation II/2 and regulation II/4 of this Protocol.

7.3.4 In decked fishing vessels of 12 m in length and over but less than 24 m in length:

- .1 Watertight doors may be of the hinged type and should be capable of being operated locally from each side of the door. A notice should be attached to the door on each side stating that the door should be kept closed at sea.
- .2 All access openings in bulkheads of enclosed deck erections, through which water could enter and endanger the vessel, should be fitted with doors permanently attached to the bulkhead, framed and stiffened so that the whole structure is of equivalent strength to the unpierced structure, and weathertight when closed, and means should be provided so that they can be operated from each side of the bulkhead.
- .3 The height above deck of sills in those doorways, companionways, deck erections and machinery casings situated on the working deck and on superstructure decks which give direct access to parts of that deck exposed to the weather and sea should be at least equal to the height of hatchway coamings as specified in 7.1.3.8.
- .4 Where operating experience has shown justification and on approval of the

competent authority, the height above deck of sills in the doorways specified in 7.3.4.3 except those giving direct access to machinery spaces, may be reduced to not less than 150 mm on superstructure decks and not less than 380 mm on the working deck for vessels 24 m in length, or not less than 150 mm on the working deck for vessels of 12 m in length. For vessels of intermediate length the minimum acceptable reduced height for sills in doorways on the working deck should be obtained by linear interpolation.

7.4 Cargo ports and other similar openings

7.4.1 Cargo ports and other similar openings in ships to which the International Convention on Load Lines, 1966 or the Protocol of 1988 relating thereto, as amended, as applicable, applies should comply with regulation 21 of this Convention.

7.4.2 Openings through which water can enter the vessel and fish flaps on stern trawlers in fishing vessels to which the 1993 Torremolinos Protocol applies should comply with regulation II/3 of this Protocol.

7.4.3 Cargo port and other similar openings in passenger ships to which the International Convention for the Safety of Life at Sea, 1974 applies should comply with regulations II-1/15, 17 and 22 of this Convention. In addition, such openings in ro-ro passenger ships to which this Convention applies, should comply with regulation II-1/17-1 of this Convention.

7.4.4 Cargo port and other similar openings in cargo ships to which the International Convention for the Safety of Life at Sea, 1974 applies should comply with regulation II-1/15-10 of this Convention.

7.5 Sidescuttles, window scuppers, inlets and discharges

7.5.1 In passenger ships to which the International Convention for the Safety of Life at Sea, 1974 applies, openings in shell plating below the bulkhead deck should comply with regulation II-1/15 of this Convention.

Watertight integrity above the bulkhead deck should comply with regulation II-1/17 of this Convention.

In addition, in ro-ro passenger ships, watertight integrity below the bulkhead deck should comply with regulation II-1/23 and integrity of the hull and superstructure should comply with regulation II-1/17-1 of this Convention.

7.5.2 In ships to which the International Convention on Load Lines, 1966 or the Protocol of 1988 relating thereto, as amended, as applicable, applies, scuppers, inlets and discharges should comply with regulation 22 and sidescuttles should comply with regulation 23 of this Convention.

7.5.3 In fishing vessels to which the 1993 Torremolinos Protocol applies, sidescuttles and windows should comply with regulation II/12 and inlets and discharges should comply with regulation II/13 of this Protocol.

7.5.4 In decked fishing vessels of 12 m in length and over but less than 24 m in length, sidescuttles, windows and other openings and inlets and discharges should comply with the following:

- .1 sidescuttles to spaces below the working deck and to enclosed spaces on the working deck should be fitted with hinged deadlights capable of being closed watertight;
- .2 sidescuttles should be fitted in a position such that their sills are above a line drawn

- parallel to the working deck at side having its lowest point 500 mm above the deepest operating waterline;
- .3 sidescuttles, together with their glasses and deadlights, should be of substantial construction to the satisfaction of the competent authority;
 - .4 skylights leading to spaces below the working deck should be of substantial construction and capable of being closed and secured weathertight, and with provision for adequate means of closing in the event of damage to the inserts. Skylights leading to machinery spaces should be avoided as far as practicable;
 - .5 toughened safety glass or suitable permanently transparent material of equivalent strength should be fitted in all wheelhouse windows exposed to the weather. The means of securing windows and the width of the bearing surfaces should be adequate, having regard to the window material used. Openings leading to spaces below deck from a wheelhouse whose windows are not provided with the protection required by 0 should be fitted with a weathertight closing appliance;
 - .6 deadlights or a suitable number of storm shutters should be provided where there is no other method of preventing water from entering the hull through a broken window or sidescuttle;
 - .7 the competent authority may accept sidescuttles and windows without deadlights in side or aft bulkheads of deck erections located on or above the working deck if satisfied that the safety of the vessel will not be impaired;
 - .8 the number of openings in the sides of the vessel below the working deck should be the minimum compatible with the design and proper working of the vessel and such openings should be provided with closing arrangements of adequate strength to ensure watertightness and the structural integrity of the surrounding structure;
 - .9 discharges led through the shell either from spaces below the working deck or from spaces within deck erections should be fitted with efficient and accessible means for preventing water from passing inboard. Normally each separate discharge should have an automatic non-return valve with a positive means of closing it from a readily accessible position. Such a valve is not required if the competent authority considers that the entry of water into the vessel through the opening is not likely to lead to dangerous flooding and that the thickness of the pipe is sufficient. The means for operating the valve with a positive means of closing should be provided with an indicator showing whether the valve is open or closed. The open inboard end of any discharge system should be above the deepest operating waterline at an angle of heel satisfactory to the competent authority;
 - .10 in machinery spaces main and auxiliary sea inlets and discharges essential for the operation of machinery should be controlled locally. Controls should be readily accessible and should be provided with indicators showing whether the valves are open or closed. Suitable warning devices should be incorporated to indicate leakage of water into the space; and

- .11 fittings attached to the shell and all valves should be of steel, bronze or other ductile material. All pipes between the shell and valves should be of steel, except that in vessels constructed of material other than steel, other suitable materials may be used.

7.5.5 In cargo ships to which the International Convention for the Safety of Life at Sea, 1974 applies, external openings should comply with regulation II-1/15-2 of this Convention.

7.6 Other deck openings

7.6.1 Miscellaneous openings in freeboard and superstructure decks in ships to which the International Convention on Load Lines, 1966 or the Protocol of 1988 relating thereto, as amended, as applicable, applies should comply with regulation 18 of this Convention.

7.6.2 In decked fishing vessels of 12 m and over where it is essential for fishing operations, flush deck scuttles of the screw, bayonet or equivalent type and manholes may be fitted provided these are capable of being closed watertight and such devices should be permanently attached to the adjacent structure. Having regard to the size and disposition of the openings and the design of the closing devices, metal-to-metal closures may be fitted if they are effectively watertight. Openings other than hatchways, machinery space openings, manholes and flush scuttles in the working or superstructure deck should be protected by enclosed structures fitted with weathertight doors or their equivalent. Companionways should be situated as close as practicable to the centreline of the vessel.³¹

7.7 Ventilators, air pipes and sounding devices

7.7.1 Ventilators in ships to which the International Convention on Load Lines, 1966 or the Protocol of 1988 relating thereto, as amended, as applicable, applies should comply with regulation 19 and air pipes should comply with regulation 20 of this Convention.

7.7.2 Ventilators in fishing vessels to which the 1993 Torremolinos Protocol applies should comply with regulation II/9 and air pipes should comply with regulation II/10 of this Protocol. Sounding devices should comply with regulation II/11 of this Protocol.

7.7.3 Ventilators and air pipes in fishing vessels of 12 m in length and over but less than 24 m in length should comply with the following:

- .1 ventilators should have coamings of substantial construction and should be capable of being closed weathertight by devices permanently attached to the ventilator or adjacent structure. Ventilators should be arranged as close to the vessel's centreline as possible and, where practicable, should extend through the top of a deck erection or companionway;
- .2 the coamings of ventilators should be as high as practicable. On the working deck the height above deck of coamings of ventilators, other than machinery space ventilators, should be not less than 760 mm and on superstructure decks not less than 450 mm. When the height of such ventilators may interfere with the working of the vessel their coaming heights may be reduced to the satisfaction of the competent authority. The height above deck of machinery space ventilator openings should be to the satisfaction of the competent authority;

³¹ Refer to regulation II/8 of the 1993 Torremolinos Protocol.

- .3 closing appliances need not be fitted to ventilators the coamings of which extend more than 2.5 m above the working deck or more than 1.0 m above a deck-house

top or superstructure deck;

- .4 where air pipes to tanks or other spaces below deck extend above the working or superstructure decks the exposed parts of the pipes should be of substantial construction and, as far as is practicable, located close to the vessel's centreline and protected from damage by fishing or lifting gear. Openings of such pipes should be protected by efficient means of closing, permanently attached to the pipe or adjacent structure, except that where the competent authority is satisfied that they are protected against water trapped on deck, these means of closing may be omitted; and
- .5 where air pipes are situated near the side of the vessel their height above deck to the point where water may have access below should be at least 760 mm on the working deck and at least 450 mm on the superstructure deck. The competent authority may accept reduction of the height of an air pipe to avoid interference with the fishing operations.

7.7.4 In offshore supply vessels air pipes and ventilators should comply with the following:

- .1 air pipes and ventilators should be fitted in protected positions in order to avoid damage by cargo during operations and to minimize the possibility of flooding. Air pipes on the exposed cargo and forecastle decks should be fitted with automatic closing devices; and
- .2 due regard should be given to the position of machinery space ventilators. Preferably they should be fitted in a position above the superstructure deck, or above an equivalent level if no superstructure deck is fitted.

7.8 Freeing ports

7.8.1 Where bulwarks on the weather portion of the freeboard or superstructure decks or, in fishing vessels, the working decks form wells, freeing ports should be arranged along the length of the bulwark as to ensure that the deck is freed of water most rapidly and effectively. Lower edges of freeing ports should be as near the deck as practicable.³²

7.8.2 In ships to which the International Convention on Load Lines, 1966 or the Protocol of 1988 as amended, as applicable, applies freeing ports should comply with regulation 24 of this Convention.

7.8.3 In decked fishing vessels of 12 m in length and over, freeing ports should comply with the following:³³

³² Refer to regulation 24(5) of the International Convention on Load Lines, 1966 or the Protocol of 1988, as amended, as applicable and regulation 11/14(4) of the 1993 Torremolinos Protocol.

³³ Refer to regulation II/4 of the 1993 Torremolinos Protocol.

7.8.3.1 The minimum freeing port area A in m^2 , on each side of the vessel for each well on the working deck, should be determined in relation to the length l and height of bulwark in the well as

follows:

.1 $A = K * l$

where:

$$K = 0.07 \text{ for vessels of 24 m in length and over}$$

$$K = 0.035 \text{ for vessels of 12 m in length; for intermediate lengths the value of } K \text{ should be obtained by linear interpolation (} l \text{ need not be taken as greater than 70\% of the vessel's length);}$$

.2 where the bulwark is more than 1.2 m in average height, the required area should be increased by 0.004 m² per metre of length of well for each 0.1 m difference in height; and

.3 where the bulwark is less than 0.9 m in average height, the required area may be decreased by 0.004 m² per metre of length of well for each 0.1 m difference in height.

7.8.3.2 The freeing port area calculated according to 7.8.3.1 should be increased where the [MCA](#) or competent authority considers that the vessel's sheer is not sufficient to ensure rapid and effective freeing of the deck of water.

7.8.3.3 Subject to the approval of the [MCA](#) or competent authority, the minimum freeing port area for each well on the superstructure deck should be not less than one-half the area A given in 7.8.3.1 except that where the superstructure deck forms a working deck for fishing operations the minimum area on each side should be not less than 75% of the area A .

7.8.3.4 Freeing ports should be so arranged along the length of bulwarks as to provide the most rapid and effective freeing of the deck from water. Lower edges of freeing ports should be as near the deck as practicable.

7.8.3.5 Pound boards and means for stowage and working the fishing gear should be arranged so that the effectiveness of the freeing ports will not be impaired or water trapped on deck and prevented from easily reaching the freeing ports. Pound boards should be so constructed that they can be locked in position when in use and will not hamper the discharge of shipped water.

7.8.3.6 Freeing ports over 0.3 m in depth should be fitted with bars spaced not more than 0.23 m nor less than 0.15 m apart or provided with other suitable protective arrangements. Freeing port covers, if fitted, should be of approved construction. If devices are considered necessary for locking freeing port covers during fishing operations they should be to the satisfaction of the competent authority and easily operable from a readily accessible position.

7.8.3.7 In vessels intended to operate in areas subject to icing, covers and protective arrangements for freeing ports should be capable of being easily removed to restrict ice accumulation. Size of opening and means provided for removal of these protective arrangements should be to the satisfaction of the competent authority.

7.8.3.8 In addition, in fishing vessels of 12 m in length and above but less than 24 m in length where wells or cockpits are fitted in the working deck or superstructure deck with their bottoms

above the deepest operating waterline, efficient non-return means of drainage overboard should be provided. Where bottoms of such wells or cockpits are below the deepest operating waterline, drainage to the bilges should be provided.

7.8.4 In offshore supply vessels the [MCA](#) should give special attention to adequate drainage of pipe stowage positions, having regard to the individual characteristics of the vessel. However, the area provided for drainage of the pipe stowage positions should be in excess of the required freeing port area in the cargo deck bulwark and should not be fitted with shutters.

7.9 Miscellaneous

7.9.1 Ships engaged in towing operations should be provided with means for quick release of the towing hawser.

Part B Chapter 8 – Determination of lightship parameters

8.1 Application

8.1.1 Every passenger ship regardless of size and every cargo ship having a length, as defined in the International Convention on Load Lines, 1966 or the Protocol of 1988 relating thereto, as amended, as applicable, of 24 m and upwards, should be inclined upon its completion and the elements of its stability determined.³⁴

8.1.2 The MCA may allow the inclining test of an individual ship as required by paragraph 8.1.1 to be dispensed with provided basic stability data are available from the inclining test of a sister ship and it is shown to the satisfaction of the MCA that reliable stability information for the exempted ship can be obtained from such basic data.

To be dispensed from an inclining test, the deviation of lightship mass is not to exceed,

for $L^{35} < 50$ m:	2% of the lightship mass of the lead ship or as given in the information on stability;
for $L > 160$ m:	1% of the lightship mass of the lead ship or as given in the information on stability;
for intermediate L :	by linear interpolation,

and the deviation of the lightship's longitudinal centre of gravity (LCG) referred to L should not be greater than 0.5% of the lightship's LCG of the lead ship or as given in the information on stability regardless of the ship's length.

8.1.3 The MCA may allow the inclining test of an individual ship or class of ships especially designed for the carriage of liquids or ore in bulk to be dispensed with when reference to existing data for similar ships clearly indicates that due to the ship's proportions and arrangements more than sufficient metacentric height will be available in all probable loading conditions.

8.1.4 Where any alterations are made to a ship so as to materially affect the stability, the ship should be re-inclined.

8.1.5 At periodic intervals not exceeding five years, a lightweight survey should be carried out on all passenger ships to verify any changes in lightship displacement and longitudinal centre of gravity. The ship should be re-inclined whenever, in comparison with the approved stability information, a deviation from the lightship displacement exceeding 2% or a deviation of the longitudinal centre of gravity exceeding 1% of L is found or anticipated.

8.1.6 The inclining test prescribed is adaptable for ships with a length below 24 m if special precautions are taken to ensure the accuracy of the test procedure.

³⁴ Refer to regulation II-1/5 of the 1974 SOLAS Convention, as amended.

³⁵ For the purpose of paragraphs 8.1.2 and 8.1.5 the length (L) means the subdivision length (LS) as defined in regulation II-1/2.1 of the 1974 SOLAS Convention, as amended. For ships to which the Convention applies, and for other ships the length (L) means the length of ship as defined in 2.12 of section 2 (Definitions) of the introduction to this Code.

8.2 Preparations for the inclining test

8.2.1 Notification of the MCA

Written notification of the inclining test should be sent to the MCA as it requires or in due time before the test. An MCA representative should be present to witness the inclining test and the test results be submitted for review.

The responsibility for making preparations, conducting the inclining test and lightweight survey, recording the data, and calculating the results rests with the shipyard, owner or naval architect. While compliance with the procedures outlined herein will facilitate an expeditious and accurate inclining test, it is recognized that alternative procedures or arrangements may be equally efficient. However, to minimize risk of delay, it is recommended that all such variances be submitted to the MCA for review prior to the inclining test.

8.2.1.1 Details of notification

Written notification should provide the following information as the Administration may require:

- .1 identification of the ship by name and shipyard hull number, if applicable;
- .2 date, time, and location of the test;
- .3 inclining weight data:
 - .1 type;
 - .2 amount (number of units and weight of each);
 - .3 certification;
 - .4 method of handling (i.e. sliding rail or crane);
 - .5 anticipated maximum angle of heel to each side;
- .4 measuring devices:
 - .1 pendulums - approximate location and length;
 - .2 U-tubes - approximate location and length;
 - .3 inclinometers - location and details of approvals and calibrations;
- .5 approximate trim;
- .6 condition of tanks;
- .7 estimated weights to deduct, to complete, and to relocate in order to place the ship in its true lightship condition;
- .8 detailed description of any computer software to be used to aid in calculations during the inclining test; and
- .9 name and telephone number of the person responsible for conducting the inclining test.

8.2.2 *General condition of the ship*

8.2.2.1 A ship should be as complete as possible at the time of the inclining test. The test should be scheduled to minimize the disruption in the ship's delivery date or its operational commitments.

8.2.2.2 The amount and type of work left to be completed (mass to be added) affect the accuracy of the lightship characteristics, so good judgment should be used. If the mass or centre of gravity of an item to be added cannot be determined with confidence, it is best to conduct the inclining test after the item is added.

8.2.2.3 Temporary material, tool boxes, staging, sand, debris, etc., on board should be reduced to absolute minimum before the inclining test. Excess crew or personnel not directly involved in the inclining test should be removed from on board the ship before the test.

8.2.2.4 Decks should be free of water. Water trapped on deck may shift and pocket in a fashion similar to liquids in a tank. Any rain, snow or ice accumulated on the ship should be removed prior to the test.

8.2.2.5 The anticipated liquid loading for the test should be included in the planning for the test. Preferably, all tanks should be empty and clean, or completely full. The number of slack tanks should be kept to an absolute minimum. The viscosity of the fluid, the depth of the fluid and the shape of the tank should be such that the free surface effect can be accurately determined.

8.2.2.6 The ship should be moored in a quiet, sheltered area free from extraneous forces such as propeller wash from passing vessels, or sudden discharges from shore side pumps. The tide conditions and the trim of the ship during the test should be considered. Prior to the test, the depth of water should be measured and recorded in as many locations as are necessary to ensure that the ship will not contact the bottom. The specific gravity of water should be accurately recorded. The ship should be moored in a manner to allow unrestricted heeling. The access ramps should be removed. Power lines, hoses, etc., connected to shore should be at a minimum, and kept slack at all times.

8.2.2.7 The ship should be as upright as possible; with inclining weights in the initial position, up to one-half degree of list is acceptable. The actual trim and deflection of keel, if practical, should be considered in the hydrostatic data. In order to avoid excessive errors caused by significant changes in the water plane area during heeling, hydrostatic data for the actual trim and the maximum anticipated heeling angles should be checked beforehand.

8.2.2.8 The total weight used should be sufficient to provide a minimum inclination of one degree and a maximum of four degrees of heel to each side. The [MCA](#) may, however, accept a smaller inclination angle for large ships provided that the requirements on pendulum deflection or U-tube difference in height in 8.2.2.9 are complied with. Test weights should be compact and of such a configuration that the vertical centre of gravity of the weights can be accurately determined. Each weight should be marked with an identification number and its mass. Re-certification of the test weights should be carried out prior to the incline. A crane of sufficient capacity and reach, or some other means, should be available during the inclining test to shift weights on the decking in an expeditious and safe manner. Water ballast transfer may be carried out, when it is impractical to incline using solid weights if acceptable to the [MCA](#).

8.2.2.9 The use of three pendulums is recommended but a minimum of two should be used to allow identification of bad readings at any one pendulum station. They should each be located in an area protected from the wind. One or more pendulums may be substituted by other measuring devices (U-tubes or inclinometers) at the discretion of the [MCA](#). Alternative measuring devices should not be used to reduce the minimum inclining angles recommended in 8.2.2.8.

The use of an inclinometer or U-tube should be considered in each separate case. It is recommended that inclinometers or other measuring devices only be used in conjunction with at

least one pendulum.

8.2.2.10 Efficient two-way communications should be provided between central control and the weight handlers and between central control and each pendulum station. One person at a central control station should have complete control over all personnel involved in the test.

8.3 Plans required

The person in charge of the inclining test should have available a copy of the following plans at the time of the inclining test:

- .1 lines plan;
- .2 hydrostatic curves or hydrostatic data;
- .3 general arrangement plan of decks, holds, inner bottoms, etc.;
- .4 capacity plan showing capacities and vertical and longitudinal centres of gravity of cargo spaces, tanks, etc. When ballast water is used as inclining weight, the transverse and vertical centres of gravity for the applicable tanks for each angle of inclination, must be available;
- .5 tank sounding tables;
- .6 draught mark locations; and
- .7 docking drawing with keel profile and draught mark corrections (if available).

8.4 Test procedure

8.4.1 Procedures followed in conducting the inclining test and lightweight survey should be in accordance with the recommendations laid out in annex 1 (Detailed guidance for the conduct of an inclining test to this Code).

8.4.1.1 Freeboard/draught readings should be taken to establish the position of the waterline in order to determine the displacement of the ship at the time of the inclining test. It is recommended that at least five freeboard readings, approximately equally spaced, be taken on each side of the ship or that all draught marks (forward, midship and aft) be read on each side of the ship. Draught/freeboard readings should be read immediately before or immediately after the inclining test.

8.4.1.2 The standard test employs eight distinct weight movements. Movement No.8, a recheck of the zero point, may be omitted if a straight-line plot is achieved after movement No.7. If a straight-line plot is achieved after the initial zero and six weight movements, the inclining test is complete and the second check at zero may be omitted. If a straight-line plot is not achieved, those weight movements that did not yield acceptable plotted points should be repeated or explained.

8.4.2 A copy of the inclining data should be forwarded to the [MCA](#) along with the calculated results of the inclining test in an acceptable report format, if required.

8.4.3 All calculations performed during the inclining test and in preparation of an inclining test report may be carried out by a suitable computer program. Output generated by such a program may be used for presentation of all or partial data and calculations included in the test report if it is

clear, concise, well documented, and generally consistent in form and content with [MCA](#) requirements.

8.5 Inclining test for MODUs

8.5.1 An inclining test should be required for the first unit of a design, when as near to completion as possible, to determine accurately the lightship data (weight and position of centre of gravity).

8.5.2 For successive units which are identical by design, the lightship data of the first unit of the series may be accepted by the [MCA](#) in lieu of an inclining test, provided the difference in lightship displacement or position of centre of gravity due to weight changes for minor differences in machinery, outfitting or equipment, confirmed by the results of a deadweight survey, are less than 1% of the values of the lightship displacement and principal horizontal dimensions as determined for the first of the series. Extra care should be given to the detailed weight calculation and comparison with the original unit of a series of column-stabilized, semi-submersible types as these, even though identical by design, are recognized as being unlikely to attain an acceptable similarity of weight or centre of gravity to warrant a waiver of the inclining test.

8.5.3 The results of the inclining test, or deadweight survey and inclining experiment adjusted for weight differences, should be indicated in the Operating Manual.

8.5.4 A record of all changes to machinery, structure, outfit and equipment that affect the lightship data, should be maintained in the Operating Manual or a lightship data alterations log and be taken into account in daily operations.

8.5.5 For column-stabilized units, a deadweight survey should be conducted at intervals not exceeding five years. Where the deadweight survey indicates a change from the calculated lightship displacement in excess of 1% of the operating displacement, an inclining test should be conducted.

8.5.6 An inclining test or a deadweight survey should be carried out in the presence of an officer of the [MCA](#), or a duly authorized person or representative of an approved organization.

8.6 Stability test for pontoons

An inclining experiment is not normally required for a pontoon, provided a conservative value of the lightship vertical centre of gravity (KG) is assumed for the stability calculations. The KG can be assumed at the level of the main deck although it is recognized that a lesser value could be acceptable if fully documented. The lightship displacement and longitudinal centre of gravity should be determined by calculation based on draught and density readings.

Part B Annex 1 – Detailed guidance for the conduct of an inclining test

1 Introduction

This annex supplements the inclining standards put forth in part B, chapter 8 (Determination of lightship parameters) of this Code. This annex contains important detailed procedures for conducting an inclining test in order to ensure that valid results are obtained with maximum precision at a minimal cost to owners, shipyards and the MCA. A complete understanding of the correct procedures used to perform an inclining test is imperative in order to ensure that the test is conducted properly and so that results can be examined for accuracy as the inclining experiment is conducted.

2 Preparations for the inclining test

2.1 Free surface and tankage

2.1.1 If there are liquids on board the ship when it is inclined, whether in the bilges or in the tanks, they will shift to the low side when the ship heels. This shift of liquids will exaggerate the heel of the ship. Unless the exact weight and distance of liquid shifted can be precisely calculated, the metacentric height (GM) calculated from the inclining test will be in error. Free surface should be minimized by emptying the tanks completely and making sure all bilges are dry; or by completely filling the tanks so that no shift of liquid is possible. The latter method is not the optimum because air pockets are difficult to remove from between structural members of a tank, and the weight and centre of the liquid in a full tank should be accurately determined in order to adjust the lightship values accordingly. When tanks must be left slack, it is desirable that the sides of the tanks be parallel vertical planes and the tanks be regular in shape (i.e. rectangular, trapezoidal, etc.) when viewed from above, so that the free surface moment of the liquid can be accurately determined. For example, the free surface moment of the liquid in a tank with parallel vertical sides can be readily calculated by the formula:

$$M_{fs} = l \cdot b^3 \cdot \rho_t / 12 \text{ (mt)}$$

where:

- l = length of tank (m)
- b = breadth of tank (m)
- ρ_t = specific gravity of liquid in tank (t/m³)

$$\text{Free surface correction} = \frac{\sum M_{fs}(1) + M_{fs}(2) + \dots + M_{fs}(x)}{\Delta} \text{ (m)}$$

where:

- M_{fs} = free surface moment (mt)
- Δ = displacement (t)

Free surface correction is independent of the height of the tank in the ship, location of the tank, and direction of heel. As the width of the tank increases, the value of free surface moment increases by the third power. The distance available for the liquid to shift is the predominant factor. This is why even the smallest amount of liquid in the bottom of a wide tank or bilge is normally unacceptable and should be removed prior to the inclining experiment. Insignificant amounts of liquids in V-shaped tanks or voids (e.g., a chain locker in the bow), where the potential shift is negligible, may remain if removal of the liquid would be difficult or would cause extensive delays.

When ballast water is used as inclining weight, the actual transverse and vertical movements of the liquid should be calculated taking into account the change of heel of the ship. Free surface corrections as defined in this paragraph should not apply to the inclining tanks.

2.1.2 Free surface and slack tanks: The number of slack tanks should normally be limited to one port/starboard pair or one centreline tank of the following:

- .1 fresh water reserve feed tanks;
- .2 fuel/diesel oil storage tanks;
- .3 fuel/diesel oil day tanks;
- .4 lube oil tanks;
- .5 sanitary tanks; or
- .6 potable water tanks.

To avoid pocketing, slack tanks should normally be of regular (i.e. rectangular, trapezoidal, etc.) cross section and be 20% to 80% full if they are deep tanks and 40% to 60% full if they are double-bottom tanks. These levels ensure that the rate of shifting of liquid remains constant throughout the heel angles of the inclining test. If the trim changes as the ship is inclined, then consideration should also be given to longitudinal pocketing. Slack tanks containing liquids of sufficient viscosity to prevent free movement of the liquids, as the ship is inclined (such as bunker at low temperature), should be avoided since the free surface cannot be calculated accurately. A free surface correction for such tanks should not be used unless the tanks are heated to reduce viscosity. Communication between tanks should never be allowed. Cross-connections, including those via manifolds, should be closed. Equal liquid levels in slack tank pairs can be a warning sign of open cross connections. A bilge, ballast, and fuel oil piping plan can be referred to, when checking for cross connection closures.

2.1.3 Pressed-up tanks: “Pressed up” means completely full with no voids caused by trim or inadequate venting. Anything less than 100% full, for example the 98% condition regarded as full for operational purposes, is not acceptable. Preferably, the ship should be rolled from side to side to eliminate entrapped air before taking the final sounding. Special care should be taken when pressing fuel oil tanks to prevent accidental pollution. An example of a tank that would appear “pressed up”, but actually contains entrapped air, is shown in figure A1-2.1.3.

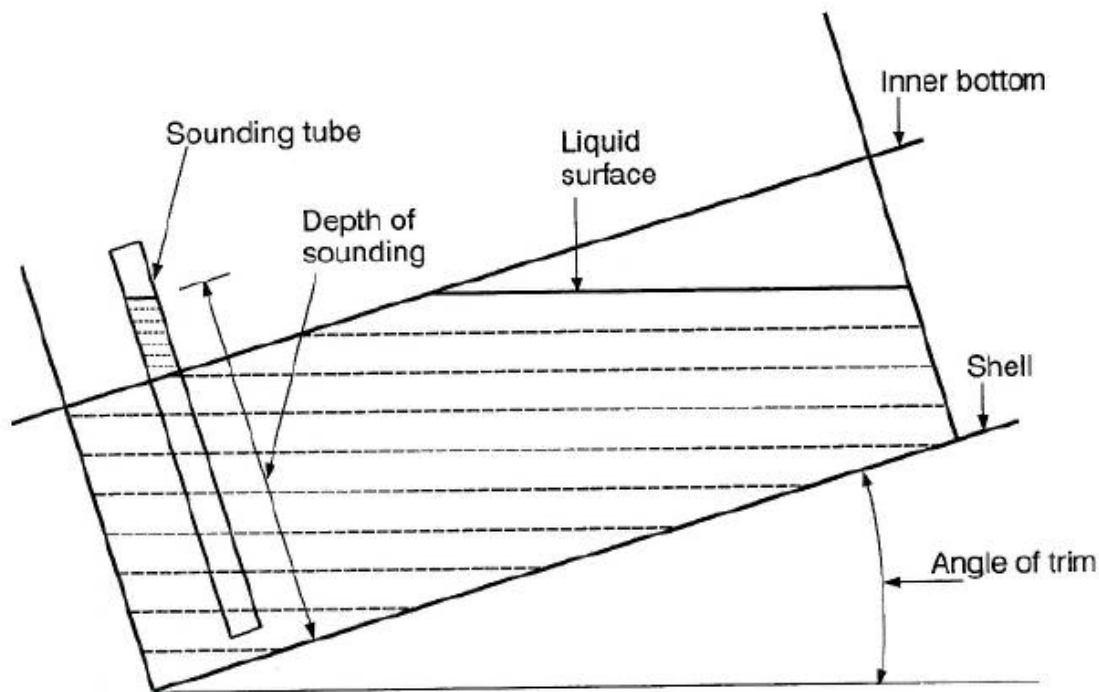

Figure A1-2.1.3

2.1.4 **Empty tanks:** It is generally not sufficient to simply pump tanks until suction is lost. Enter the tank after pumping to determine if final stripping with portable pumps or by hand is necessary. The exceptions are very narrow tanks or tanks where there is a sharp deadrise, since free surface would be negligible. Since all empty tanks should be inspected, all manholes should be open and the tanks well ventilated and certified as safe for entry. A safe testing device should be on hand to test for sufficient oxygen and minimum toxic levels. A certified marine chemist's certificate certifying that all fuel oil and chemical tanks are safe for human entry should be available, if necessary.

2.2 Mooring arrangements

The importance of good mooring arrangements cannot be overemphasized. The arrangement selections will be dependent upon many factors. Among the most important are depth of water, wind and current effects. Whenever possible, the ship should be moored in a quiet, sheltered area free from extraneous forces such as propeller wash from passing ships, or sudden discharges from shore side pumps. The depth of water under the hull should be sufficient to ensure that the hull will be entirely free of the bottom. The tide conditions and the trim of the ship during the test should be considered. Prior to the test, the depth of water should be measured and recorded in as many locations as necessary to ensure the ship will not contact the bottom. If marginal, the test should be conducted during high tide or the ship moved to deeper water.

2.2.1 The mooring arrangement should ensure that the ship will be free to list without restraint for a sufficient period of time to allow a satisfactory reading of the heeling angle, due to each weight shift, to be recorded.

2.2.2 The ship should be held by lines at the bow and the stern, attached to bollards and/or cleats

on the deck. If suitable restraint of the ship cannot be achieved using deck fittings, then temporary padeyes should be attached as close as possible to the centreline of the ship and as near the waterline as practical. Where the ship can be moored to one side only, it is good practice to supplement the bow and stern lines with two spring lines in order to maintain positive control of the ship, as shown in figure A1-2.2.2. The leads of the spring lines should be as long as practicable. Cylindrical camels should be provided between the ship and the dock. All lines should be slack, with the ship free of the pier and camels, when taking readings.

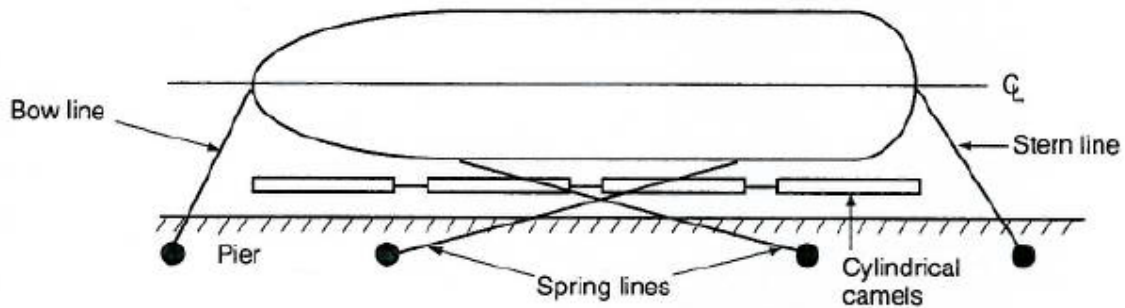

Figure A1-2.2.2

2.2.2.1 If the ship is held off the pier by the combined effect of the wind and current, a superimposed heeling moment will act on the ship throughout the test. For steady conditions this will not affect the results. Gusty winds or uniformly varying wind and/or current will cause these superimposed heeling moments to change, which may require additional test points to obtain a valid test. The need for additional test points can be determined by plotting test points as they are obtained.

2.2.2.2 If the ship is pressed against the fenders by wind and/or current, all lines should be slack. The cylindrical camels will prevent binding but there will be an additional superimposed heeling moment due to the ship bearing against the camels. This condition should be avoided where possible but, when used, consideration should be given to pulling the ship free of the dock and camels and letting the ship drift as readings are taken.

2.2.2.3 Another acceptable arrangement is where the combined wind and current are such that the ship may be controlled by only one line at either the bow or the stern. In this case, the control line should be led from on or near the centreline of the ship with all lines but the control line slack, the ship is free to veer with the wind and/or current as readings are taken. This can sometimes be troublesome because varying wind and/or current can cause distortion of the plot.

2.2.3 The mooring arrangement should be submitted to the approval authority for review prior to the test.

2.2.4 If a floating crane is used to handle inclining weights, it should not be moored to the ship.

2.3 Test weights

2.3.1 Weights, such as porous concrete, that can absorb significant amounts of moisture should only be used if they are weighed just prior to the inclining test or if recent weight certificates are presented. Each weight should be marked with an identification number and its weight. For small ships, drums completely filled with water may be used. Drums should normally be full and capped to allow accurate weight control. In such cases, the weight of the drums should be verified in the

presence of the [MCA](#) representative using a recently calibrated scale.

2.3.2 Precautions should be taken to ensure that the decks are not overloaded during weight movements. If deck strength is questionable then a structural analysis should be performed to determine if existing framing can support the weight.

2.3.3 Generally, the test weights should be positioned as far outboard as possible on the upper deck. The test weights should be on board and in place prior to the scheduled time of the inclining test.

2.3.4 Where the use of solid weights to produce the inclining moment is demonstrated to be impracticable, the movement of ballast water may be permitted as an alternative method. This acceptance would be granted for a specific test only, and approval of the test procedure by the [MCA](#) is required. As a minimal prerequisite for acceptability, the following conditions should be required:

- .1 inclining tanks should be wall-sided and free of large stringers or other internal members that create air pockets. Other tank geometries may be accepted at the discretion of the [MCA](#);
- .2 tanks should be directly opposite to maintain ship's trim;
- .3 specific gravity of ballast water should be measured and recorded;
- .4 pipelines to inclining tanks should be full. If the ship's piping layout is unsuitable for internal transfer, portable pumps and pipes/hoses may be used;
- .5 blanks must be inserted in transfer manifolds to prevent the possibility of liquids being "leaked" during transfer. Continuous valve control must be maintained during the test;
- .6 all inclining tanks must be manually sounded before and after each shift;
- .7 vertical, longitudinal and transverse centres should be calculated for each movement;
- .8 accurate sounding/ullage tables must be provided. The ship's initial heel angle should be established prior to the incline in order to produce accurate values for volumes and transverse and vertical centres of gravity for the inclining tanks at every angle of heel. The draught marks amidships (port and starboard) should be used when establishing the initial heel angle;
- .9 verification of the quantity shifted may be achieved by a flow meter or similar device; and
- .10 the time to conduct the inclining must be evaluated. If time requirements for transfer of liquids are considered too long, water may be unacceptable because of the possibility of wind shifts over long periods of time.

2.4 Pendulums

2.4.1 The pendulums should be long enough to give a measured deflection, to each side of upright, of at least 15 cm. Generally, this will require a pendulum length of at least 3 m. It is recommended that pendulum lengths of 4 to 6 m be used. Usually, the longer the pendulum the greater the accuracy of the test; however, if excessively long pendulums are used on a tender ship the pendulums may not settle down and the accuracy of the pendulums would then be

questionable. On large ships with high GM, pendulum lengths in excess of the length recommended above may be required to obtain the minimum deflection. In such cases, the trough, as shown in figure A1-2.4.6, should be filled with high-viscosity oil. If the pendulums are of different lengths, the possibility of collusion between station recorders is avoided.

2.4.2 On smaller ships, where there is insufficient headroom to hang long pendulums, the 15 cm deflection should be obtained by increasing the test weight so as to increase the heel. On most ships the typical inclination is between one and four degrees.

2.4.3 The pendulum wire should be piano wire or other monofilament material. The top connection of the pendulum should afford unrestricted rotation of the pivot point. An example is that of a washer with the pendulum wire attached suspended from a nail.

2.4.4 A trough filled with a liquid should be provided to dampen oscillations of the pendulum after each weight movement. It should be deep enough to prevent the pendulum weight from touching the bottom. The use of a winged plumb bob at the end of the pendulum wire can also help to dampen the pendulum oscillations in the liquid.

2.4.5 The battens should be smooth, light-coloured wood, 1 to 2 cm thick, and should be securely fixed in position so that an inadvertent contact will not cause them to shift. The batten should be aligned close to the pendulum wire but not in contact with it.

2.4.6 A typical satisfactory arrangement is shown in figure A1-2.4.6. The pendulums may be placed in any location on the ship, longitudinally and transversely. The pendulums should be in place prior to the scheduled time of the inclining test.

2.4.7 It is recommended that inclinometers or other measuring devices only be used in conjunction with at least one pendulum. The MCA may approve an alternative arrangement when this is found impractical.

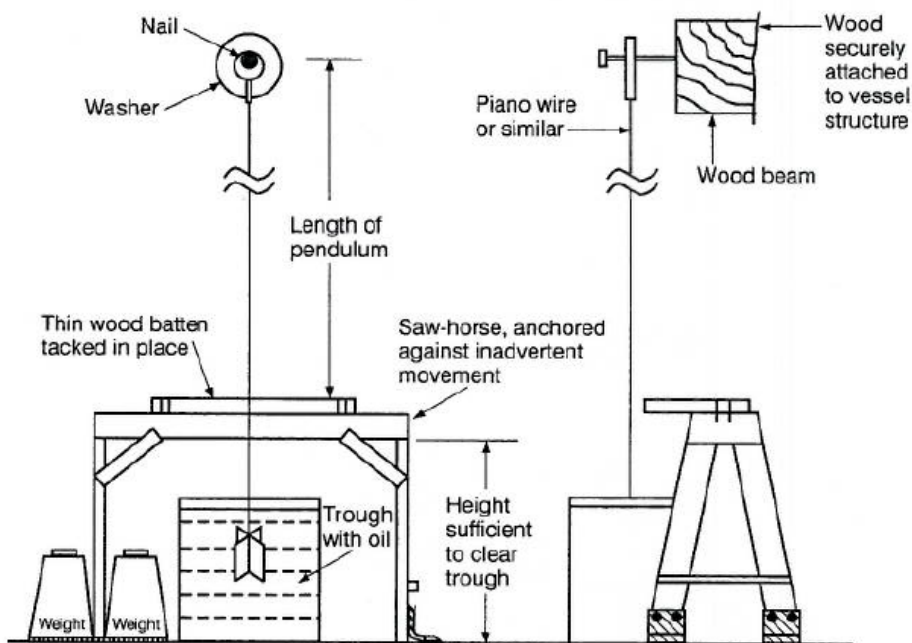

Figure A1-2.4.6

2.5 U-tubes

2.5.1 The legs of the device should be securely positioned as far as outboard as possible and should be parallel to the centreline plane of the ship. The distance between the legs should be measured perpendicular to the centreline plane. The legs should be vertical, as far as practical.

2.5.2 Arrangements should be made for recording all readings at both legs. For easy reading and checking for air pockets, clear plastic tube or hose should be used throughout. The U-tube should be pressure-tested prior to the inclining test to ensure watertightness.

2.5.3 The horizontal distance between the legs of the U-tube should be sufficient to obtain a level difference of at least 15 cm between the upright and the maximum inclination to each side.

2.5.4 Normally, water would be used as the liquid in the U-tube. Other low-viscosity liquids may also be considered.

2.5.5 The tube should be free of air pockets. Arrangements should be made to ensure that the free flow of the liquid in the tube is not obstructed.

2.5.6 Where a U-tube is used as a measuring device, due consideration should be given to the prevailing weather conditions (see 4.1.1.3):

- .1 if the U-tube is exposed to direct sunlight, arrangements should be made to avoid temperature differences along the length of the tube;
- .2 if temperatures below 0°C are expected, the liquid should be a mixture of water and an anti-freeze additive; and
- .3 where heavy rain squalls can be expected, arrangements should be made to avoid additional water entering the U-tube.

2.6 Inclometers

The use of inclinometers should be subject to at least the following recommendations:

- .1 the accuracy should be equivalent to that of the pendulum;
- .2 the sensitivity of the inclinometer should be such that the non-steady heeling angle of the ship can be recorded throughout the measurement;
- .3 the recording period should be sufficient to accurately measure the inclination. The recording capacity should be generally sufficient for the whole test;
- .4 the instrument should be able to plot or print the recorded inclination angles on paper;
- .5 the instrument should have linear performance over the expected range of inclination angles;
- .6 the instrument should be supplied with the manufacturer's instructions giving details of calibration, operating instructions, etc.; and
- .7 it should be possible to demonstrate the required performance to the satisfaction of the [MCA](#) during the inclining test.

3 Equipment required

Besides the physical equipment necessary such as the inclining weights, pendulums, small boat, etc., the following are necessary and should be provided by or made available to the person in charge of the inclining:

- .1 engineering scales for measuring pendulum deflections (rules should be subdivided sufficiently to achieve the desired accuracy);
- .2 sharp pencils for marking pendulum deflections;
- .3 chalk for marking the various positions of the inclining weights;
- .4 a sufficiently long measuring tape for measuring the movement of the weights and locating different items on board;
- .5 a sufficiently long sounding tape for sounding tanks and taking freeboard readings;
- .6 one or more well maintained specific gravity hydrometers with range sufficient to cover 0.999 to 1.030, to measure the specific gravity of the water in which the ship is floating (a hydrometer for measuring specific gravity of less than 1.000 may be needed in some locations);
- .7 other hydrometers as necessary to measure the specific gravity of any liquids on board;
- .8 graph paper to plot inclining moments versus tangents;
- .9 a straight edge to draw the measured waterline on the lines drawing;
- .10 a pad of paper to record data;
- .11 an explosion-proof testing device to check for sufficient oxygen and absence of lethal gases in tanks and other closed spaces such as voids and cofferdams;
- .12 a thermometer; and
- .13 draught tubes (if necessary).

4 Test procedure

The inclining experiment, the freeboard/draught readings and the survey may be conducted in any order and still achieve the same results. If the person conducting the inclining test is confident that the survey will show that the ship is in an acceptable condition and there is the possibility of the weather becoming unfavourable, then it is suggested that the inclining be performed first and the survey last. If the person conducting the test is doubtful that the ship is complete enough for the test, it is recommended that the survey be performed first since this could invalidate the entire test, regardless of the weather conditions. It is very important that all weights, the number of people on board, etc., remain constant throughout the test.

4.1 Initial walk through and survey

The person responsible for conducting the inclining test should arrive on board the ship well in advance of the scheduled time of the test to ensure that the ship is properly prepared for the test.

If the ship to be inclined is large, a preliminary walk through may need to be done the day preceding the actual incline. To ensure the safety of personnel conducting the walk through, and to improve the documentation of surveyed weights and deficiencies, at least two persons should make the initial walk through. Things to check include: all compartments are open, clean, and dry, tanks are well ventilated and gas-free, movable or suspended items are secured and their position documented, pendulums are in place, weights are on board and in place, a crane or other method for moving weights is available, and the necessary plans and equipment are available. Before beginning the inclining test, the person conducting the test should:

- .1 consider the weather conditions. The combined adverse effect of wind, current and sea may result in difficulties or even an invalid test due to the following:
 - .1 inability to accurately record freeboards and draughts;
 - .2 excessive or irregular oscillations of the pendulums;
 - .3 variations in unavoidable superimposed heeling moments;

In some instances, unless conditions can be sufficiently improved by moving the ship to a better location, it may be necessary to delay or postpone the test. Any significant quantities of rain, snow, or ice should be removed from the ship before the test. If bad weather conditions are detected early enough and the weather forecast does not call for improving conditions, the [MCA](#) representative should be advised prior to departure from the office and an alternative date scheduled;

- .2 make a quick overall survey of the ship to make sure the ship is complete enough to conduct the test and to ensure that all equipment is in place. An estimate of items which will be outstanding at the time of the inclining test should be included as part of any test procedure submitted to the [MCA](#). This is required so that the [MCA](#) representative can advise the shipyard/naval architect if in their opinion the ship will not be sufficiently complete to conduct the incline and that it should be rescheduled. If the condition of the ship is not accurately depicted in the test procedure and at the time of the inclining test the [MCA](#) representative considers that the ship is in such condition that an accurate incline cannot be conducted, the representative may refuse to accept the incline and require that the incline be conducted at a later date;
- .3 enter all empty tanks after it is determined that they are well ventilated and gas-free to ensure that they are dry and free of debris. Ensure that any pressed-up tanks are indeed full and free of air pockets. The anticipated liquid loading for the incline should be included in the procedure required to be submitted to the [MCA](#);
- .4 survey the entire ship to identify all items which need to be added to the ship, removed from the ship, or relocated on the ship to bring the ship to the lightship condition. Each item should be clearly identified by weight and vertical and longitudinal location. If necessary, the transverse location should also be recorded. The inclining weights, the pendulums, any temporary equipment and dunnage, and the people on board during the inclining test are all among the weights to be removed to obtain the lightship condition. The person calculating the lightship characteristics from the data gathered during the incline and survey and/or the person reviewing the inclining test may not have been present during the test and should be able to determine the exact location of the items from the data recorded and the ship's drawings. Any tanks containing liquids should be accurately sounded and the soundings recorded;
- .5 it is recognized that the weight of some items on board, or that are to be added, may have to be estimated. If this is necessary, it is in the best interest of safety to

be on the safe side when estimating, so the following rules of thumb should be followed:

- .1 when estimating weights to be added:
 - .1.1 estimate high for items to be added high in the ship; and
 - .1.2 estimate low for items to be added low in the ship;
- .2 when estimating weights to be removed:
 - .2.1 estimate low for items to be removed from high in the ship; and
 - .2.2 estimate high for items to be removed from low in the ship;
- .3 when estimating weights to be relocated:
 - .3.1 estimate high for items to be relocated to a higher point in the ship; and
 - .3.2 estimate low for items to be relocated to a lower point in the ship.

4.2 Freeboard/draught readings

4.2.1 Freeboard/draught readings should be taken to establish the position of the waterline in order to determine the displacement of the ship at the time of the inclining test. It is recommended that at least five freeboard readings, approximately equally spaced, be taken on each side of the ship or that all draught marks (forward, midship, and aft) be read on each side of the ship. Draught mark readings should be taken to assist in determining the waterline defined by freeboard readings, or to verify the vertical location of draught marks on ships where their location has not been confirmed. The locations for each freeboard reading should be clearly marked. The longitudinal location along the ship should be accurately determined and recorded since the (moulded) depth at each point will be obtained from the ship's lines. All freeboard measurements should include a reference note clarifying the inclusion of the coaming in the measurement and the coaming height.

4.2.2 Draught and freeboard readings should be read immediately before or immediately after the inclining test. Weights should be on board and in place and all personnel who will be on board during the test, including those who will be stationed to read the pendulums, should be on board and in location during these readings. This is particularly important on small ships. If readings are made after the test, the ship should be maintained in the same condition as during the test. For small ships, it may be necessary to counterbalance the list and trim effects of the freeboard measuring party. When possible, readings should be taken from a small boat.

4.2.3 A small boat should be available to aid in the taking of freeboard and draught mark readings. It should have low freeboard to permit accurate observation of the readings.

4.2.4 The specific gravity of the flotation water should be determined at this time. Samples should be taken from a sufficient depth of the water to ensure a true representation of the flotation water and not merely surface water, which could contain fresh water from run-off of rain. A hydrometer should be placed in a water sample and the specific gravity read and recorded. For large ships, it is recommended that samples of the flotation water be taken forward, midship, and aft and the readings averaged. For small ships, one sample taken from midships should be

sufficient. The temperature of the water should be taken and the measured specific gravity corrected for deviation from the standard, if necessary. A correction to water specific gravity is not necessary if the specific gravity is determined at the inclining experiment site. Correction is necessary if specific gravity is measured when sample temperature differs from the temperature at the time of the inclining (e.g., if check of specific gravity is done at the office).

4.2.5 A draught mark reading may be substituted for a given freeboard reading at that longitudinal location if the height and location of the mark have been verified to be accurate by a keel survey while the ship was in dry-dock.

4.2.6 A device, such as a draught tube, can be used to improve the accuracy of freeboard/draught readings by damping out wave action.

4.2.7 The dimensions given on a ship's lines drawing are normally moulded dimensions. In the case of depth, this means the distance from the inside of the bottom shell to the inside of the deck plate. In order to plot the ship's waterline on the lines drawing, the freeboard readings should be converted to moulded draughts. Similarly, the draught mark readings should be corrected from extreme (bottom of keel) to moulded (top of keel) before plotting. Any discrepancy between the freeboard/draught readings should be resolved.

4.2.8 The mean draught (average of port and starboard readings) should be calculated for each of the locations where freeboard/draught readings are taken and plotted on the ship's lines drawing or outboard profile to ensure that all readings are consistent and together define the correct waterline. The resulting plot should yield either a straight line or a waterline which is either hogged or sagged. If inconsistent readings are obtained, the freeboards/draughts should be retaken.

4.3 The incline

4.3.1 Prior to any weight movements the following should be checked:

- .1 the mooring arrangement should be checked to ensure that the ship is floating freely (this should be done just prior to each reading of the pendulums);
- .2 the pendulums should be measured and their lengths recorded. The pendulums should be aligned so that when the ship heels, the wire will be close enough to the batten to ensure an accurate reading but will not come into contact with the batten. The typical satisfactory arrangement is shown in figure A1-2.4.6;
- .3 the initial position of the weights is marked on the deck. This can be done by tracing the outline of the weights on the deck;
- .4 the communications arrangement is adequate; and
- .5 all personnel are in place.

4.3.2 A plot should be run during the test to ensure that acceptable data are being obtained. Typically, the abscissa of the plot will be heeling moment $W(x)$ (weight times distance x) and the ordinate will be the tangent of the heel angle (deflection of the pendulum divided by the length of the pendulum). This plotted line does not necessarily pass through the origin or any other particular point for no single point is more significant than any other point. A linear regression analysis is often used to fit the straight line. The weight movements shown in figure A2-4.3.2-1 give a good spread of points on the test plot.

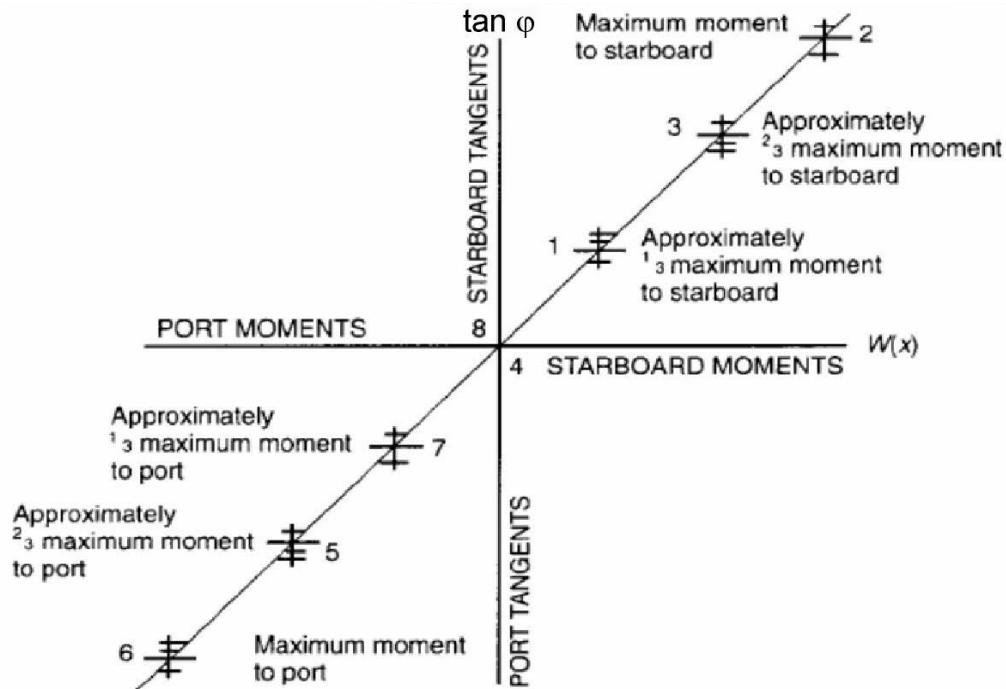

Figure A1-4.3.2-1

The plotting of all the readings for each of the pendulums during the inclining experiment aids in the discovery of bad readings. Since $W(x)/\tan \phi$ should be constant, the plotted line should be straight. Deviations from a straight line are an indication that there were other moments acting on the ship during the inclining. These other moments should be identified, the cause corrected, and the weight movements repeated until a straight line is achieved. Figures A1-4.3.2-2 to A1-4.3.2-5 illustrate examples of how to detect some of these other moments during the inclining, and a recommended solution for each case. For simplicity, only the average of the readings is shown on the inclining plots.

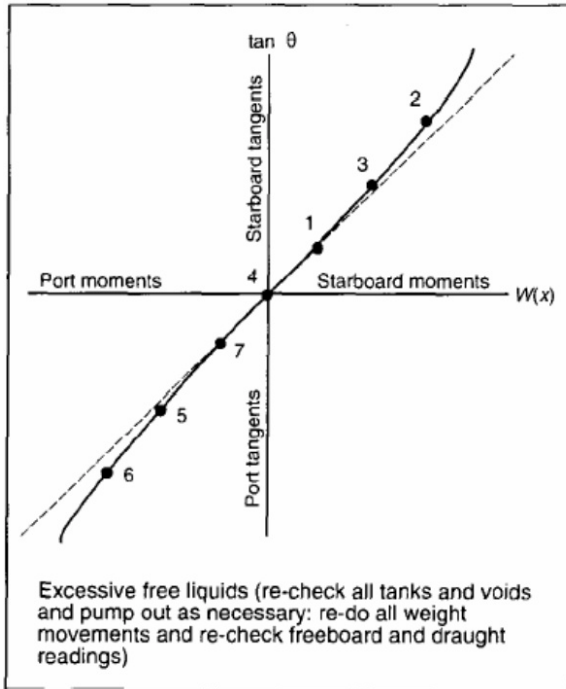

Figure A1-4.3.2-2

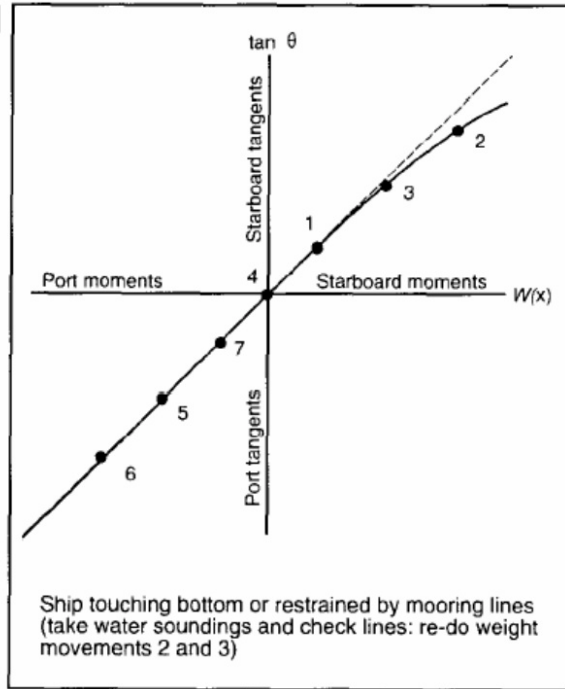

Figure A1-4.3.2-3

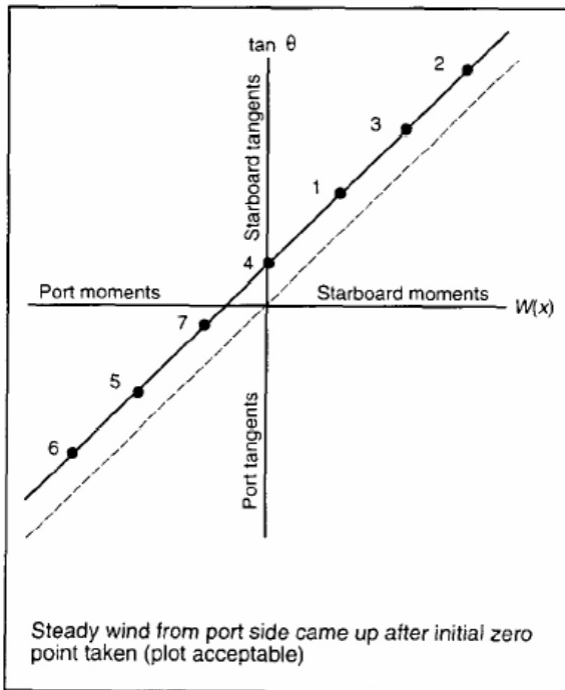

Figure A1-4.3.2-4

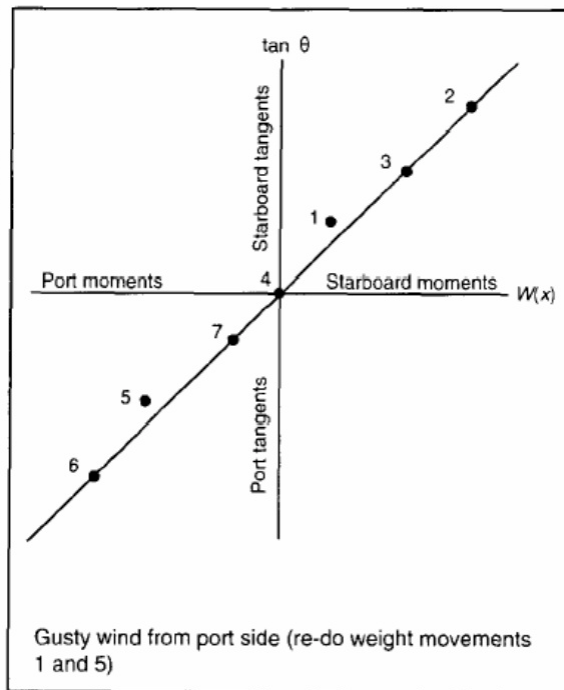

Figure A1-4.3.2-5

4.3.3 Once everything and everyone is in place, the zero position should be obtained and the remainder of the experiment conducted as quickly as possible, while maintaining accuracy and proper procedures, in order to minimize the possibility of a change in environmental conditions during the test.

4.3.4 Prior to each pendulum reading, each pendulum station should report to the control station when the pendulum has stopped swinging. Then, the control station will give a “standby” warning and then a “mark” command. When “mark” is given, the batten at each position should be marked at the location of the pendulum wire. If the wire was oscillating slightly, the centre of the oscillations should be taken as the mark. If any of the pendulum readers does not think the reading was a good one, the reader should advise the control station and the point should be retaken for all pendulum stations. Likewise, if the control station suspects the accuracy of a reading, it should be repeated for all the pendulum stations. Next to the mark on the batten should be written the number of the weight movement, such as zero for the initial position and one to seven for the weight movements.

4.3.5 Each weight movement should be made in the same direction, normally transversely, so as not to change the trim of the ship. After each weight movement, the distance the weight was moved (centre to centre) should be measured and the heeling moment calculated by multiplying the distance by the amount of weight moved. The tangent is calculated for each pendulum by dividing the deflection by the length of the pendulum. The resultant tangents are plotted on the graph. Provided there is good agreement among the pendulums with regard to the $\tan \phi$ value, the average of the pendulum readings may be graphed instead of plotting each of the readings.

4.3.6 Inclining data sheets should be used so that no data are forgotten and so that the data are clear, concise, and consistent in form and format. Prior to departing the ship, the person conducting the test and the [MCA](#) representative should initial each data sheet as an indication of their concurrence with the recorded data.

Part B Annex 2 – Recommendations for skippers of fishing vessels on ensuring a vessel's endurance in conditions of ice formation**1 Prior to departure**

1.1 Firstly, the skipper should, as in the case of any voyages in any season, ensure that the vessel is generally in a seaworthy condition, giving full attention to basic requirements such as:

- .1 loading of the vessel within the limits prescribed for the season (paragraph 1.2.1 below);
- .2 weathertightness and reliability of the devices for closing cargo and access hatches, outer doors and all other openings in the decks and superstructures of the vessel and the watertightness of the sidescuttles and of ports or similar openings in the sides below the freeboard deck to be checked;
- .3 condition of the freeing ports and scuppers as well as operational reliability of their closures to be checked;
- .4 emergency and life-saving appliances and their operational reliability;
- .5 operational reliability of all external and internal communication equipment; and
- .6 condition and operational reliability of the bilge and ballast pumping systems.

1.2 Further, with special regard to possible ice accretion, the skipper should:

- .1 consider the most critical loading condition against approved stability documents with due regard to fuel and water consumption, distribution of supplies, cargoes and fishing gear and with allowance for possible ice accretion;
- .2 be aware of the danger in having supplies and fishing gear stored on open weather deck spaces due to their large ice accretion surface and high centre of gravity;
- .3 ensure that a complete set of warm clothing for all members of the crew is available on the vessel as well as a complete set of hand tools and other appliances for combating ice accretion, a typical list thereof for small vessels is shown in section 4 of this annex;
- .4 ensure that the crew is acquainted with the location of means for combating ice accretion, as well as the use of such means, and that drills are carried out so that members of the crew know their respective duties and have the necessary practical skills to ensure the vessel's endurance under conditions of ice accretion;
- .5 acquaint himself with the meteorological conditions in the region of fishing grounds and en route to the place of destination; study the synoptical maps of this region and weather forecasts; be aware of warm currents in the vicinity of the fishing grounds, of the nearest coastline relief, of the existence of protected bays and of the location of ice fields and their boundaries; and
- .6 acquaint himself with the timetable of the radio stations transmitting weather forecasts and warnings of the possibility of ice accretion in the area of the relevant fishing grounds.

2 At sea

2.1 During the voyage and when the vessel is on the fishing grounds the skipper should keep himself informed on all long-term and short-term weather forecasts and should arrange for the following systematic meteorological observations to be systematically recorded:

- .1 temperatures of the air and of the sea surface;
- .2 wind direction and force;
- .3 direction and height of waves and sea state;
- .4 atmospheric pressure, air humidity; and
- .5 frequency of splashing per minute and the intensity of ice accumulation on different parts of the vessel per hour.

2.2 All observed data should be recorded in the vessel's log-book. The skipper should compare the weather forecasts and icing charts with actual meteorological conditions, and should estimate the probability of ice formation and its intensity.

2.3 When the danger of ice formation arises, the following measures should be taken without delay:

- .1 all the means of combating ice formation should be ready for use;
- .2 all the fishing operations should be stopped, the fishing gear should be taken on board and placed in the under-deck spaces. If this cannot be done all the gear should be fastened for storm conditions on its prescribed place. It is particularly dangerous to leave the fishing gear suspended since its surface for ice formation is large and the point of suspension is generally located high;
- .3 barrels and containers with fish, packing, all gear and supplies located on deck as well as portable mechanisms should be placed in closed spaces as low as possible and firmly lashed;
- .4 all cargoes in holds and other compartments should be placed as low as possible and firmly lashed;
- .5 the cargo booms should be lowered and fastened;
- .6 deck machinery, hawser reels and boats should be covered with duck covers;
- .7 lifelines should be fastened on deck;
- .8 freeing ports fitted with covers should be brought into operative condition, all objects located near scuppers and freeing ports and preventing water drainage from deck should be taken away;
- .9 all cargo and companion hatches, manhole covers, weathertight outside doors in superstructures and deck-houses and portholes should be securely closed in order to ensure complete weathertightness of the vessel, access to the weather deck from inner compartments should be allowed only through the superstructure deck;
- .10 a check should be carried out as to whether the amount of water ballast on board and its location is in accordance with that recommended in "Stability guidance to skippers"; if there is sufficient freeboard, all the empty bottom tanks fitted with

ballast piping should be filled with seawater;

- .11 all fire-fighting, emergency and life-saving equipment should be ready for use;
- .12 all drainage systems should be checked for their effectiveness;
- .13 deck lighting and searchlights should be checked;
- .14 a check should be carried out to make sure that each member of the crew has warm clothing; and
- .15 reliable two-way radio communication with both shore stations and other vessels should be established; radio calls should be arranged for set times.

2.4 The skipper should seek to take the vessel away from the dangerous area, keeping in mind that the lee edges of icefields, areas of warm currents and protected coastal areas are a good refuge for the vessel during weather when ice formation occurs.

2.5 Small fishing vessels on fishing grounds should keep nearer to each other and to larger vessels.

2.6 It should be remembered that the entry of the vessel into an icefield presents certain danger to the hull, especially when there is a high sea swell. Therefore the vessel should enter the icefield at a right angle to the icefield edge at low speed without inertia. It is less dangerous to enter an icefield bow to the wind. If a vessel must enter an icefield with the wind on the stern, the fact that the edge of the ice is denser on the windward side should be taken into consideration. It is important to enter the icefield at the point where the ice floes are the smallest.

3 During ice formation

3.1 If in spite of all measures taken the vessel is unable to leave the dangerous area, all means available for removal of ice should be used as long as it is subjected to ice formation.

3.2 Depending on the type of vessel, all or many of the following ways of combating ice formation may be used:

- .1 removal of ice by means of cold water under pressure;
- .2 removal of ice with hot water and steam; and
- .3 breaking up of ice with ice crows, axes, picks, scrapers, or wooden sledgehammers and clearing it with shovels.

3.3 When ice formation begins, the skipper should take into account the recommendations listed below and ensure their strict fulfilment:

- .1 report immediately ice formation to the shipowner and establish with him constant radio communication;
- .2 establish radio communication with the nearest vessels and ensure that it is maintained;
- .3 do not allow ice formation to accumulate on the vessel, immediately take steps to remove from the vessel's structures even the thinnest layer of ice and ice sludge from the upper deck;

- .4 check constantly the vessel's stability by measuring the roll period of the vessel during ice formation. If the rolling period increases noticeably, immediately take all possible measures in order to increase the vessel's stability;
- .5 ensure that each member of the crew working on the weather deck is warmly dressed and wears a safety line securely attached to the guardrail;
- .6 bear in mind that the work of the crew on ice clearing entails the danger of frost-bite. For this reason it is necessary to make sure that members of the crew working on deck are replaced periodically;
- .7 keep the following structures and gears of the vessel first free from ice:
 - .7.1 aerials;
 - .7.2 running and navigational lights;
 - .7.3 freeing ports and scuppers;
 - .7.4 lifesaving craft;
 - .7.5 stays, shrouds, masts and rigging;
 - .7.6 doors of superstructures and deck-houses; and
 - .7.7 windlass and hawse holes;
- .8 remove the ice from large surfaces of the vessel, beginning with the upper structures (such as bridges, deck-houses, etc.), because even a small amount of ice on them causes a drastic worsening of the vessel's stability;
- .9 when the distribution of ice is not symmetrical and a list develops, the ice must be cleared from the lower side first. Bear in mind that any correction of the list of the vessel by pumping fuel or water from one tank to another may reduce stability during the process when both tanks are slack;
- .10 when a considerable amount of ice forms on the bow and a trim appears, ice must be quickly removed. Water ballast may be redistributed in order to decrease the trim;
- .11 clear ice from the freeing ports and scuppers in due time in order to ensure free drainage of the water from the deck;
- .12 check regularly for water accumulation inside the hull;
- .13 avoid navigating in following seas since this may drastically worsen the vessel's stability;
- .14 register in the vessel's log-book the duration, nature and intensity of ice formation, amount of ice on the vessel, measures taken to combat ice formation and their effectiveness; and
- .15 if, in spite of all the measures taken to ensure the vessel's endurance in conditions of ice formation, the crew is forced to abandon the vessel and embark on life-saving craft (lifeboats, rafts) then, in order to preserve their lives, it is necessary to

do all possible to provide all the crew with warm clothing or special bags as well as to have a sufficient number of lifelines and bailers for speedy bailing out of water from the life-saving craft.

4 List of equipment and hand tools

A typical list of equipment and hand tools required for combating ice formation:

- .1 ice crows or crowbars;
- .2 axes with long handles;
- .3 picks;
- .4 metal scrapers;
- .5 metal shovels;
- .6 wooden sledge-hammers;
- .7 fore and aft lifelines to be rigged each side of the open deck fitted with travellers to which lizards can be attached.

Safety belts with spring hooks should be provided for no less than 50% of the members of the crew (but not less than 5 sets), which can be attached to the lizards.

- Notes:**
- 1 The number of hand tools and lifesaving appliances may be increased, at the Shipowner's discretion.
 - 2 Hoses which may be used for ice combating should be readily available on board.

Note: the amendments highlighted are from MSC.415(97) and enter into force 1st January 2020.

The insertion of a recommended model for the presentation of permissible tensions as function of α might be beneficial for a universal information standard. This uniform presentation will facilitate the circulation and the familiarization of the operators with the ship and its equipment.

A possible graphic presentation of the permissible tension is here included as an example, both table and diagram format.

PERMISSIBLE WIRE TENSION TABLE FOR A SAMPLE AHTS																					
Trim (M)	-0.5	0.0	0.5	-0.5	0.0	0.5	-0.5	0.0	0.5	-0.5	0.0	0.5									
Angle α	0			10			20			30			45			60			90		
Draft (M)																					
Between the Centerline Towing Pins																					
4.8	700	700	700	700	700	690	625	580	540	460	460	435	290	290	290	190	190	190	165	165	165
5.8	700	700	700	700	700	690	655	600	570	430	485	435	285	285	310	190	180	200	170	165	170
6.8	700	635	520	700	635	520	645	575	510	550	485	415	355	355	305	280	240	220	200	205	200
Between the Outer Towing Pins																					
4.8	545	500	465	480	435	405	385	380	350	300	300	300	215	215	215	170	170	170	165	165	165
5.8	575	520	465	500	455	405	360	390	350	275	300	300	220	210	240	180	175	180	170	165	170
6.8	555	480	410	500	435	370	440	385	330	365	340	295	260	270	235	210	215	200	200	205	200
Towing Pin at the Edge of the Cargo Rail																					
4.8	280	280	270	260	260	260	235	235	235	215	215	215	180	180	180	170	170	170	160	160	160
5.8	255	290	280	240	260	265	230	235	230	210	200	235	190	180	200	175	170	180	165	160	165
6.8	345	310	270	320	300	260	290	285	245	260	270	230	220	230	210	205	210	200	195	200	185
Max Wire Pull: 600 t Max Brake Force: 700 t Max Dynamic Brake: 700 t Resulting Fd = 700 t																					
Trim is Negative by the bow. Interpolate between drafts only. For trim between table values, use lower permissible tension.						Permissible tensions shown are in Tonnes. Required tension should not exceed the winches capabilities or the values in the above table.															
Table is for Planning and Monitoring AHTS operation. Specific loading conditions may be required for each anchor move.						If wire angle falls into the yellow zone, and wire tension exceeds the permissible value, corrective actions are required															
Trim should be minimized or by bow for anchor moves where high wire tensions are expected.						If wire angle falls into the red zone, and the wire tension exceeds the permissible value, halt operations, reduce line tension															
Wire angle (alpha α) is relative to vessel's centerline, and is assumed to always be outboard. If angle is exceeded, use next higher angle.						If planned wire tension exceeds green values above, additional Calculations required. Operations should not be planned for high angles.															
Grey region indicates where the angle of tow wire is not geometrically possible. Permissible tensions are provided for reference only.						Vessel loading must be in accordance with the approved stability book and include any assumed margins															

Figure A3-1: Permissible tension table for ship with 3 tow points

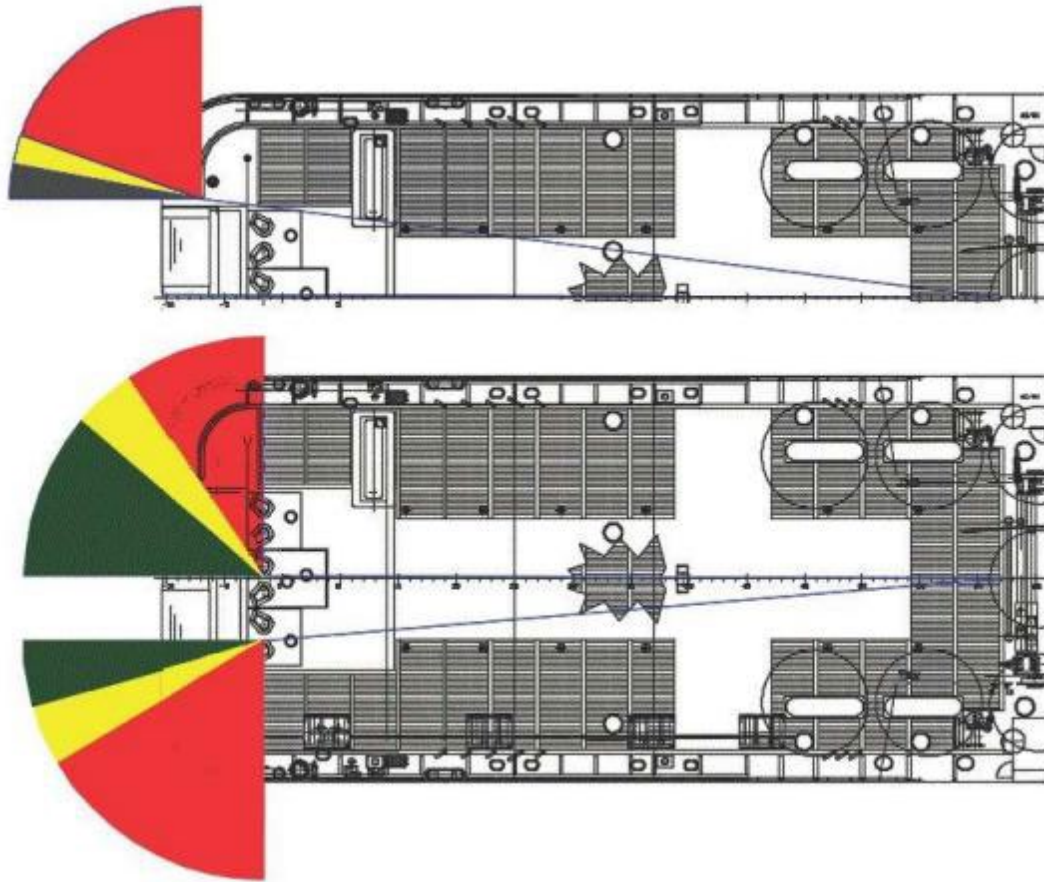

Figure A3-2: Illustration of the operational, cautionary, and stop work zones (coded respectively "Green", "Yellow" and "Red" zones)

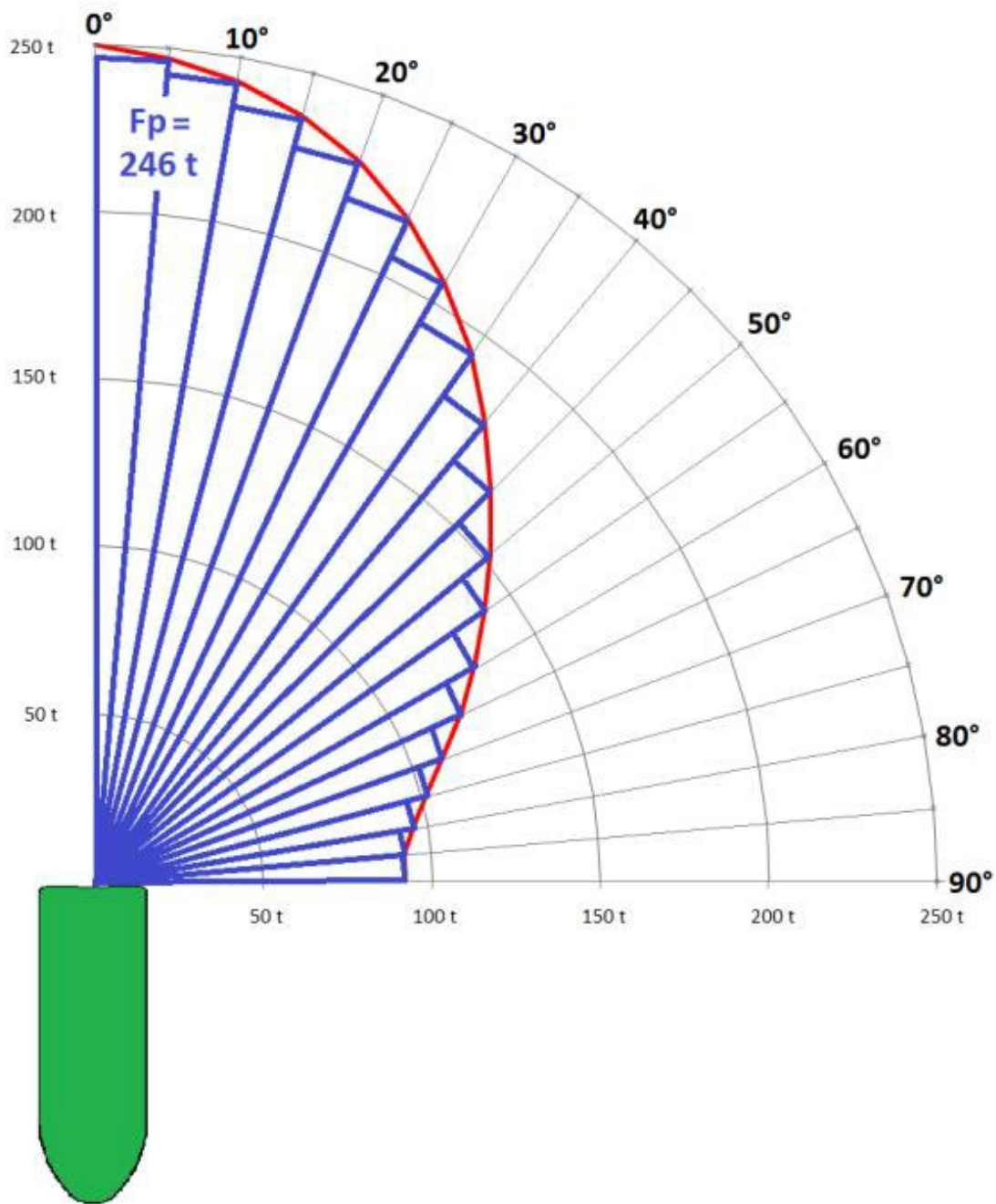

Figure A3-3: Permissible tension sector diagram based on standard alpha values (5°, 10°, 15°, 90°)

Guidance on the Explanatory Notes to the International Code on Intact Stability 2008 (2008 IS Code)**Contents****Chapter 1 – General**

- 1.1 [Introduction](#)
- 1.2 [Purpose](#)

Chapter 2 – [Terminology](#)**Chapter 3 – Origin of present stability criteria**

- 3.1 [General](#)
- 3.2 [Background of criteria regarding righting lever curve properties \(part A of the 2008 IS Code\)](#)
- 3.3 [Background of the approximate formula for the minimum *GM0* for small fishing vessels \(part B, paragraph 2.1.5.1 of the 2008 IS Code\)](#)
- 3.4 [References relating to paragraphs 3.1 to 3.3](#)
- 3.5 [Background of the severe wind and rolling criterion \(weather criterion\)](#)
- 3.6 [References relating to paragraph 3.5](#)

Chapter 4 – Guidance for the application of the 2008 IS code

- 4.1 [Criteria regarding righting lever curve properties](#)

EXPLANATORY NOTES TO THE INTERNATIONAL CODE ON INTACT STABILITY, 2008

Explanatory Notes Chapter 1- General

1.1 Introduction

The intact stability criteria given in part A (mandatory) and part B (recommendatory) of the 2008 IS Code are prescriptive rules developed from ship operation statistics and weather criterion collected in the middle of the twentieth century. To enable a proper understanding and application of these criteria, their origin and development are presented in chapter 3.

1.2 Purpose

The purpose of these explanatory notes is to deliver to the user of the Code information on the history, background and method of elaboration of the present stability criteria, as set out in part A of the 2008 IS Code.

Explanatory Notes Chapter 2 - Terminology

It should be noted that, while the terms listed below are in common usage, they are not those given in MSC/Circ.920, MODEL LOADING AND STABILITY MANUAL, section 2.2, table 1, which are based on ISO standards (ISO 7462 and ISO 7463).

Particular care should be taken with regard to asymmetric weight and buoyancy distribution.

Term, as used in the 2008 IS Code	Term, as used in MSC/Circ.920	Explanation
LCG	XG	Longitudinal Centre of Gravity (m from aft perpendicular) Longitudinal distance from reference point to centre of gravity, reference point usually at aft perpendicular (forward + / aft -).
TCG	YG	Transversal Centre of Gravity (m from centreline) Transversal distance from reference point to centre of gravity, reference point in the Midship Plane (port + / starboard -).
VCG	KG	Vertical Centre of Gravity (m above baseline) Vertical distance from reference point to centre of gravity, reference point on the centreline (upwards + / down -).
LCB	XB	Longitudinal Centre of Buoyancy (m from aft perpendicular) Longitudinal distance from reference point to centre of buoyancy, reference point usually at aft perpendicular (forward + / aft -).
TCB	--	Transversal Centre of Buoyancy (m from centreline) Transversal distance from reference point to centre of buoyancy, reference point on the centreline (port + / starboard -).
VCB	--	Vertical Centre of Buoyancy (m above baseline) Vertical distance from reference point to centre of buoyancy, reference point on baseline (upward + / down -).
LCF	XF	Longitudinal Centre of Flotation (m from aft perpendicular) Longitudinal distance from reference point to centre of flotation, reference point usually at aft perpendicular (forward + / aft -).
TCF	--	Transversal Centre of Flotation (m from centreline) Transversal distance from reference point to centre of flotation, reference point on the centreline (port + / starboard -).

In all cases it is of utmost importance to define clearly the reference points/planes and the signs of the positive and negative directions along the vessel's coordinate system.

Explanatory Notes Chapter 3 - Origin of present stability criteria**3.1 General**

3.1.1 The Maritime Safety Committee requested the Sub-Committee on Stability and Load Lines and on Fishing Vessels Safety (SLF), to develop a range of intact stability requirements to cover all ship types for eventual incorporation into the 1974 SOLAS Convention. At the thirty-third session of the Sub-Committee (SLF 33), the Working Group on Intact Stability considered this matter and foresaw the procedural problems that would arise by incorporating a wide range of stability criteria covering different ship types into the Convention, and also recognized that these criteria could not be developed in a short time. The group recommended that, alternatively, consideration should be given to developing a comprehensive code to incorporate the then existing stability requirements contained in all IMO recommendations and codes for various types of ships. Criteria for additional ship types could be added later as each ship type was considered and a criterion developed. The group also suggested that the 1974 SOLAS Convention should either: include a basic stability standard and refer to the Code for varying ship types or, alternatively, it should only refer to the Code. The proposed Code could be divided into two parts: part A containing mandatory requirements, and part B containing recommendatory requirements. Development of the proposed Code was given priority (IMO 1988).

3.1.2 In considering the proposal by the group, SLF 33 agreed that the development of a stability code for all ships covered by IMO instruments (IS Code) would be of value, so that the generally accepted and special stability requirements for all types of ships' forms would be contained in a single publication for ease of reference. This was thought to be important because stability requirements were dissipated amongst various documents which made their use by designers and authorities difficult (IMO 1988a). The Sub-Committee emphasized that the Code should contain instructions on operational procedures as well as technical design characteristics. This course of action was approved by the Maritime Safety Committee at its fifty-seventh session.

3.1.3 The collation of the stability requirements contained in various IMO instruments and the preparation of the first draft of the Code was undertaken by Poland and submitted to IMO [IMO 1990]. This formed the basis for the development of the Code which was to include the following groups of requirements as proposed by Poland (Kobylnski 1989):

- .1 ship construction;
- .2 physical characteristics of ships;
- .3 information available onboard and navigational aids; and
- .4 operations.

3.1.4 This framework was eventually adopted by SLF 35, which also agreed that the Code should have recommendatory status. The final draft of the Code was agreed by SLF 37 and subsequently adopted by resolution A.749(18) (IMO 1993)]. It was subsequently amended in 1998 by resolution MSC.75(69). The Code was considered to be a "living" document under constant review, into which all new requirements developed by IMO would be incorporated.

3.2 Background of criteria regarding righting lever curve properties (part A of the 2008 IS Code)**3.2.1 Introduction**

3.2.1.1 The statistical stability criteria were originally included in resolutions A.167(ES.IV) and A.168(ES.IV). They were developed as a result of discussions conducted at several sessions of the Sub-Committee on Subdivision and Stability Problems (STAB), a forerunner of the SLF Sub-Committee and the Working Group on Intact Stability. There was general agreement that the

criteria would have to be developed on the basis of the statistical analysis of stability parameters of ships that had suffered casualties and of ships that were operating safely.*

3.2.1.2 The Working Group on Intact Stability agreed to a programme of work that eventually included the following items:

- .1 collation, analysis and evaluation of existing national rules or recommendations on stability;
- .2 evaluation of stability parameters which could be used as stability criteria;
- .3 collection of stability characteristics of those ships that become casualties or experienced dangerous heeling under circumstances suggesting insufficient stability;
- .4 collection of stability characteristics of those ships which were operating with safe experience;
- .5 comparative analysis of stability parameters of ships becoming casualties and of ships operated safely;
- .6 estimation of critical values of chosen stability parameters; and
- .7 checking formulated criteria against a certain number of existing ships.

3.2.1.3 The analysis of existing national stability requirements (paragraph 3.2.1.2.1) [IMO 1964] revealed considerable consistency in the applicability of certain parameters as stability criteria. It was noted also that in many countries there was a tendency to adopt weather criterion. However, weather criterion was not considered by the Working Group on Intact Stability at that time.

3.2.1.4 With regard to paragraph 3.2.1.2.2 of the programme, the Working Group on Intact Stability singled out a group of parameters characterizing the curve of righting levers for the ship at rest ($V = 0$) in still water. This was done notwithstanding the fact that if a ship sails in a seaway, the curve of static stability levers changes. However, it was decided that the only practical solution would be to use the “stipulated” curve of righting levers and this curve could be characterized using the following set of parameters:

- .1 initial stability – GM_0 ,
- .2 righting levers at angles – GZ_{10} , GZ_{20} , GZ_{30} , GZ_{40} , GZ_{φ} , GZ_m ,
- .3 angles – φ_m , φ_v , φ_f , φ_{fd} ,
- .4 levers of dynamic stability – e_{20} , e_{30} , e_{40} , e_{φ} .

3.2.1.5 The number of stability parameters which could be used as stability criteria should be, however, limited. Therefore, by analysing the parameters used in various national stability requirements, the Working Group on Intact Stability concluded the following eight parameters have to be left for further consideration: GM_0 , GZ_{20} , GZ_{30} , GZ_m , φ_m , φ_v , φ_{fd} , e .

* The detailed discussion of the work of these IMO bodies and of the method used in the development of stability standards was reported in the following papers: Nadeinski and Jens (1968) and Thompson and Tope (1970).

3.2.1.6 During the realization of paragraph 3.2.1.2.3 of the programme, a special form of casualty record was prepared and circulated amongst IMO Member States (IMO 1963). It was requested that the form be filled in carefully with as many details of the casualty as possible. Altogether there were casualty records collected for 68 passenger and cargo ships and for 38 fishing vessels (IMO 1966, 1966a). In a later period, some countries submitted further casualty records so that, in the second analysis that was performed in 1985, data for 93 passenger and cargo ships and for 73 fishing vessels were available (IMO 1985). On the basis of the submitted data, tables of details of casualties were prepared.

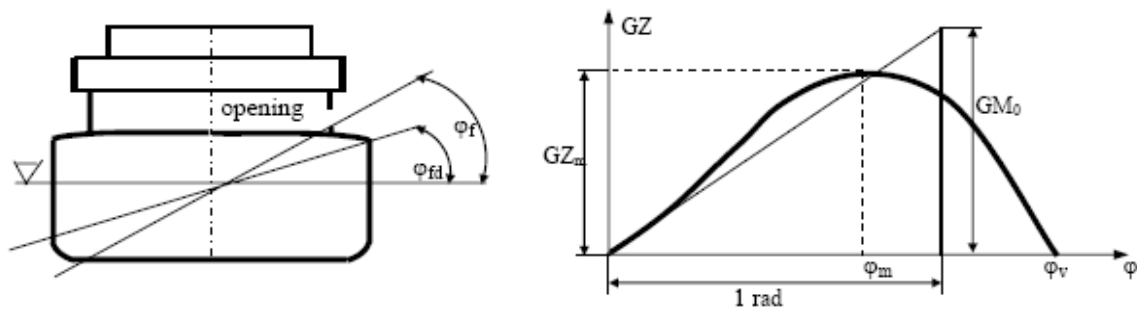

Figure 1 – Explanation of righting levers and heeling angles

3.2.1.7 Within paragraph 3.2.1.2.4 of the programme, data on stability characteristics for 62 passenger and cargo ships and for 48 fishing vessels, which were operated safely, were collected and for this purpose a special instruction containing detailed specifications for the manner how the stability information was to be submitted was developed. Also, for these ships, tables were prepared of stability parameters.

3.2.1.8 Paragraph 3.2.1.2.5 of the programme included analysis of the collected data, the results of which were submitted to IMO in several documents separately prepared for passenger and cargo ships and for fishing vessels [IMO 1965; 1966; 1966a; 1966b].

3.2.1.9 After IMO resolutions A.167(ES.IV) and A.168(ES.IV) had been adopted and further intact stability casualty data were collected, it was decided to repeat the analysis in order to find out if additional data might change conclusions drawn in the first analysis. This second analysis confirmed, in general, the results achieved in the first analysis [IMO 1985]. In the following text, the results of the second analysis that was based on the larger database are referred to.

3.2.1.10 The analysis performed consisted of two parts. In the first part, details relevant to casualties were evaluated, which allowed qualitative conclusions with regard to the circumstances of casualties to be developed and therefore the specification of general safety precautions. In the second part, stability parameters of ships reported as casualties were compared with those for ships which were operated safely. Two methods were adopted in this analysis. The first was identical with the method adopted by Rahola (Rahola 1939) and the second was the discrimination analysis. The results of the analysis of intact stability casualty data and of the first part of the analysis of stability parameters are included in paragraph 3.2.2.2. The results of the discrimination analysis are referred to in paragraph 3.2.2.3.

3.2.2 Results of the Analysis of Intact Stability Casualty Records and Stability Parameters

3.2.2.1 Analysis of details relevant to the casualties

3.2.2.1.1 The evaluation of details relevant to the casualties is shown in figures 2 to 7.

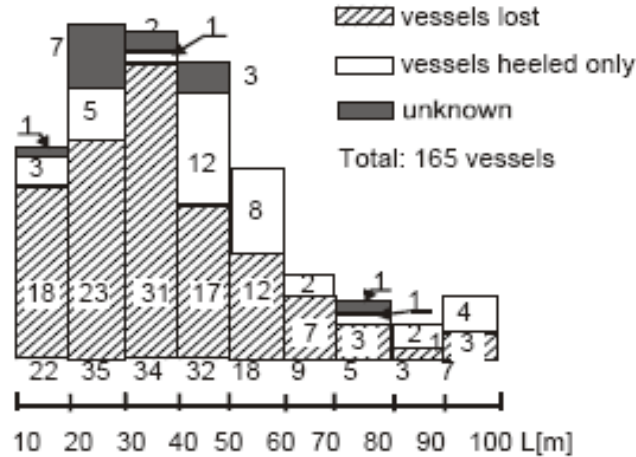

Figure 2 – Distribution of length of capsized ships collated by IMO (1985)

3.2.2.1.2 In all 166 casualties reported, the ships concerned were: 80 cargo ships, 1 cargo and passenger ship, 1 bulk carrier, 4 off-shore supply ships, 7 special service vessels, and 73 fishing vessels. Distribution of ship’s length is shown in figure 2. It is seen that the majority of casualties occurred in ships of less than 60 m in length.

3.2.2.1.3 A great variety of cargoes were carried so that no definite conclusions could be drawn. It may be noted, however, that in 35 cases of the 80 cargo ships reported, deck cargo was present.

3.2.2.1.4 The result of the analysis of the location of the casualty is shown in figure 3. It may be seen that the majority of casualties (72% of all casualties) occurred in restricted water areas, in estuaries and along the coastline. This is understandable because the majority of ships lost were small ships of under 60 m in length. From the analysis of the season when the casualty occurred (figure 4) it may be seen that the most dangerous season is autumn (41% of all casualties).

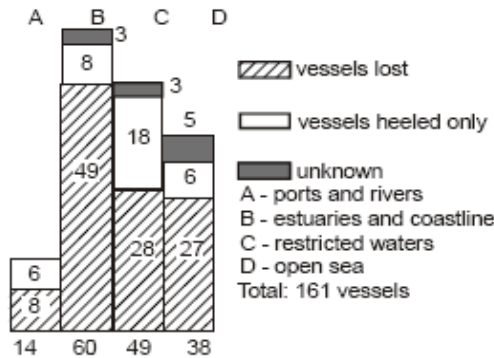

Figure 3 – Place of casualty (IMO 1985)

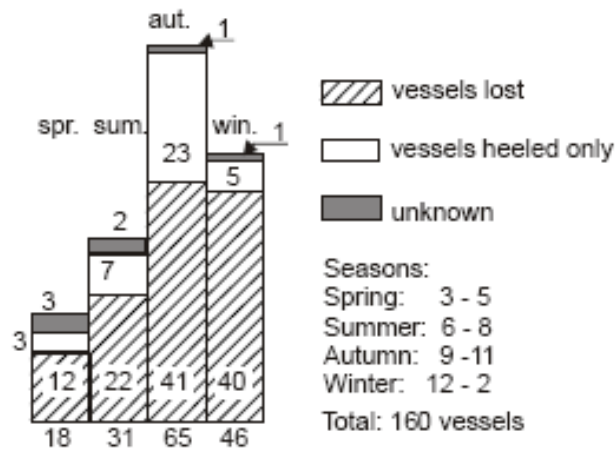

Figure 4 – Season of casualty (IMO 1985)

3.2.2.1.5 The result of the analysis of the weather conditions is shown in figure 5. About 75% of all casualties occurred in rough seas at a wind force of between Beaufort 4 to 10. Ships were sailing most often in beam seas, less often in quartering and following seas.

3.2.2.1.6 The manner of the casualty was also analysed (figure 6). It showed that the most common casualty was through gradual or sudden capsizing. In about 30% of casualties, ships survived the casualty and were heeled only.

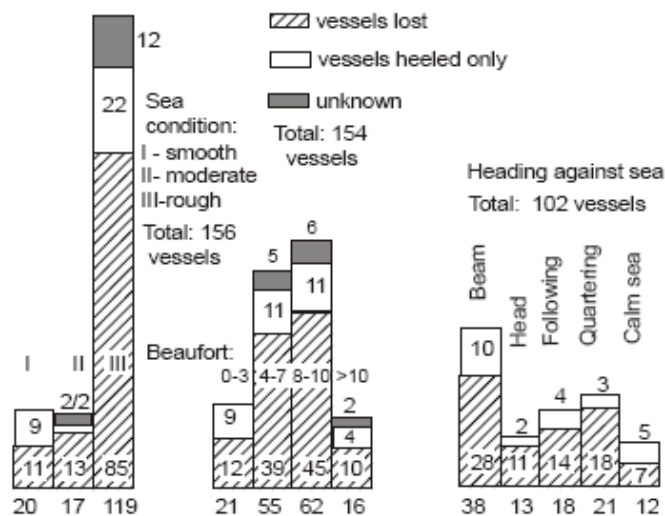

Figure 5 – Sea and wind condition during casualty (IMO 1985)

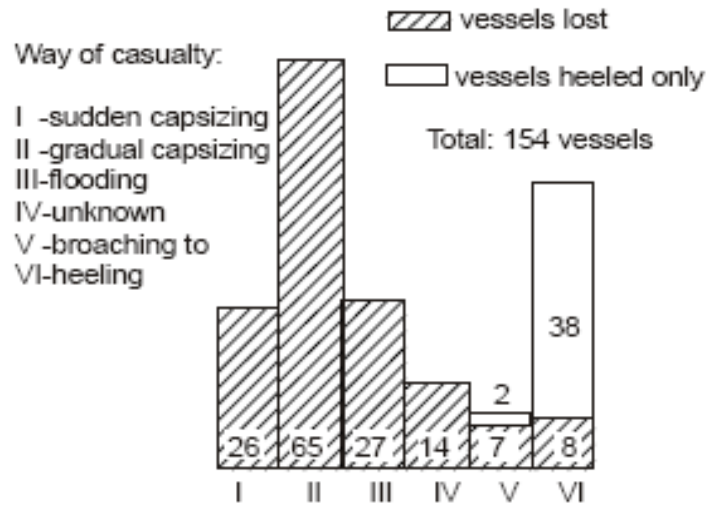

Fig. 6 – Way of casualty (IMO 1985)

3.2.2.1.7 In figure 7 the results of the analysis of the age of ships are shown. No definite conclusions could be drawn from this analysis.

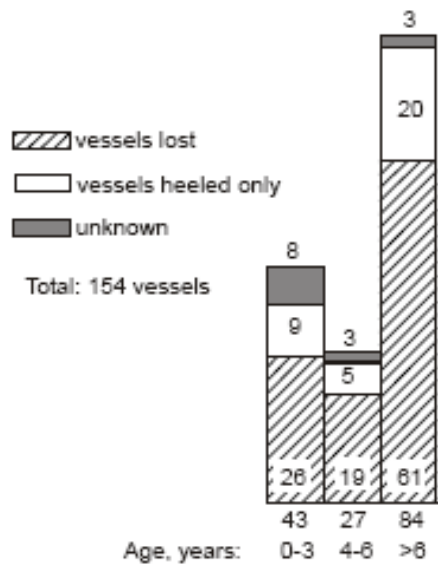

Fig. 7 – Age of vessel during casualty (IMO 1985)

3.2.2.1.8 The distributions of stability parameters for ships' condition at time of loss are shown in figures 8 to 14.

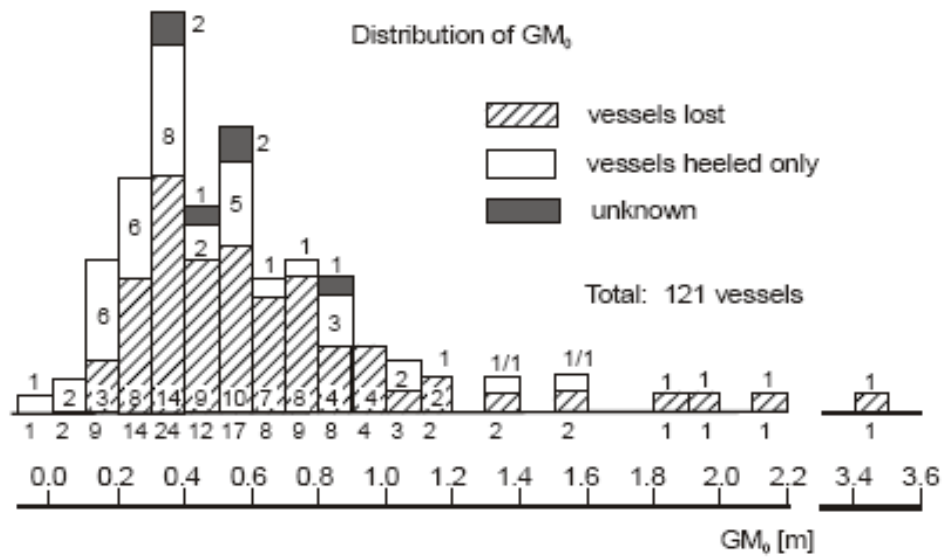

Figure 8 – Condition at time of casualty. Distribution of GM_0 (IMO 1985)

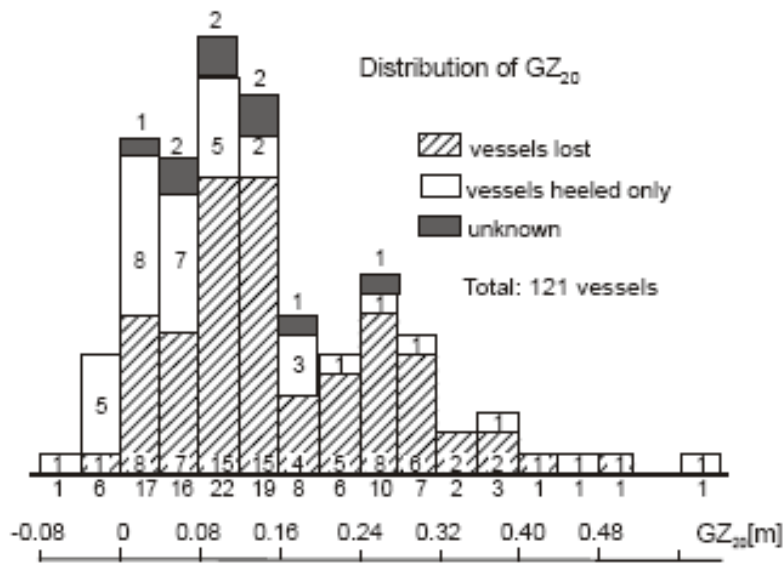

Figure 9 – Condition at time of casualty. Distribution of GZ_{20} (IMO 1985)

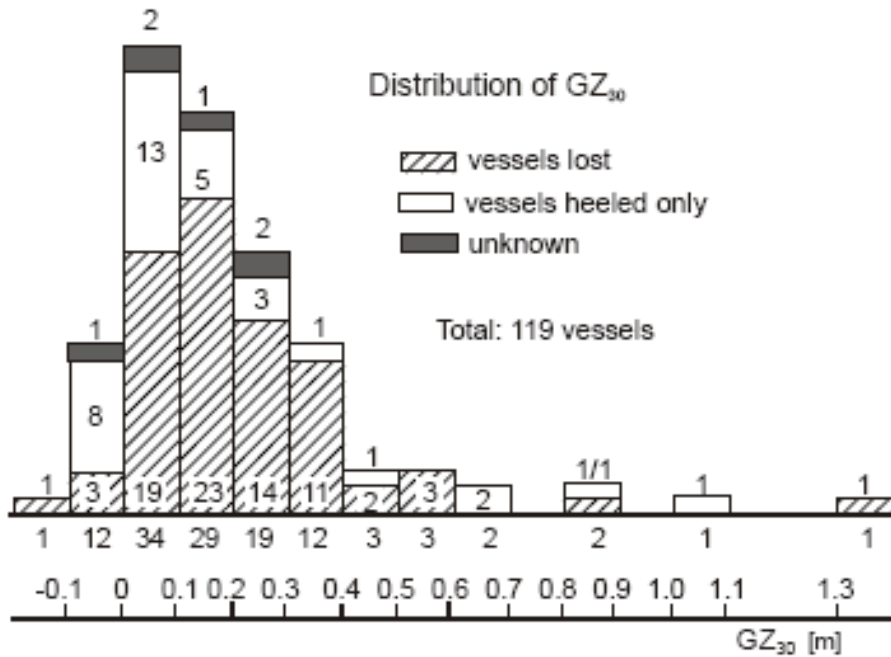

Figure 10 – Condition at time of casualty. Distribution of GZ_{30} (IMO 1985)

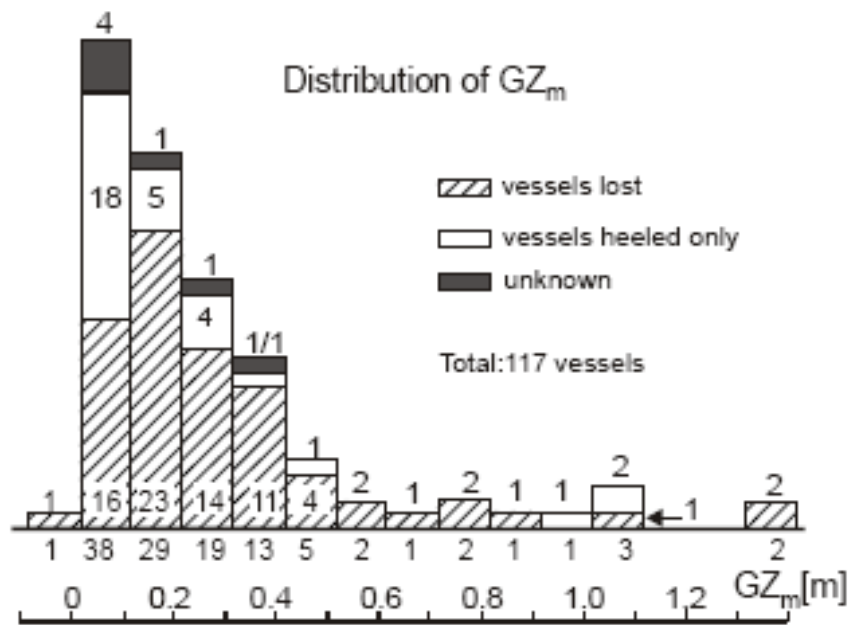

Figure 11 – Condition at time of casualty. Distribution of GZ_m (IMO 1985)

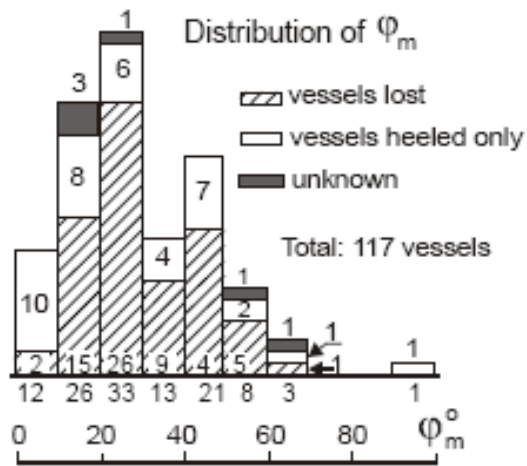

Figure 12 – Condition at time of casualty. Distribution of φ_m (IMO 1985)

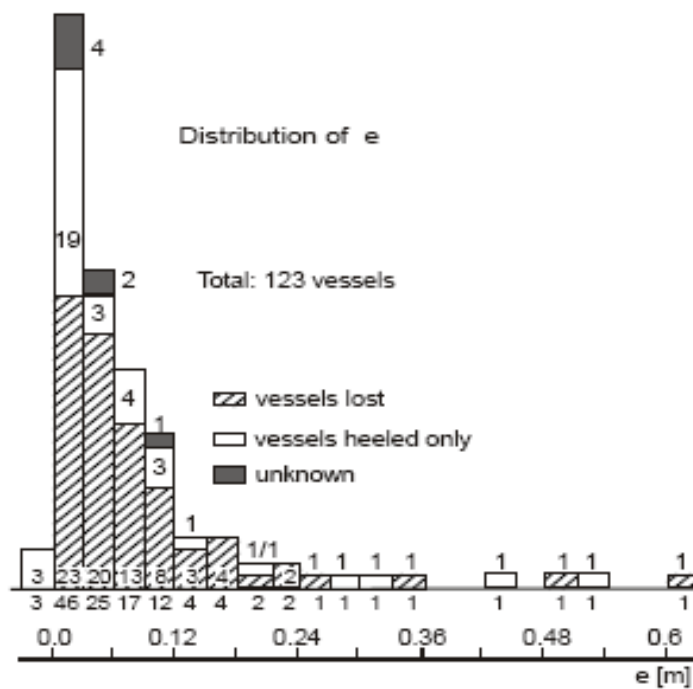

Figure 13 – Condition at time of casualty. Distribution of e (IMO 1985)

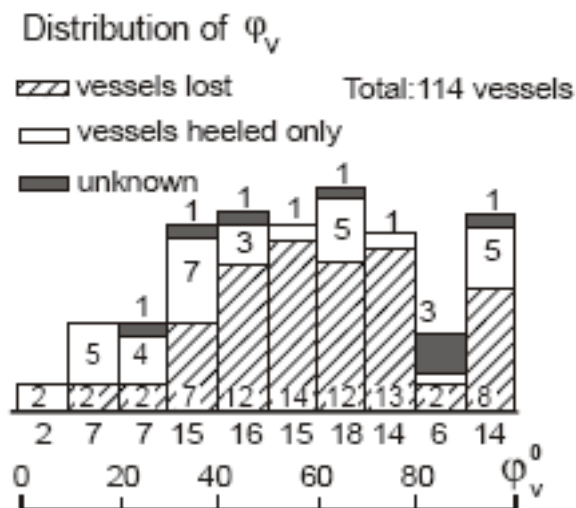

Figure 14 – Condition at time of casualty. Distribution of ϕ_v (IMO 1985)

3.2.2.2 Analysis of stability parameters using Rahola method

3.2.2.2.1 The stability parameters for casualty condition were analysed by plotting in a similar manner, as was done by Rahola, together with parameters for ships operated safely for comparison.

3.2.2.2.2 The parameters chosen for analysis were GM_0 , GZ_{20} , GZ_{30} , GZ_{40} , GZ_m , e_{40} and ϕ_m . From the available data, histograms were prepared, where respective values of stability parameters for casualty condition were entered by starting with the highest value at the left of the vertical line (ordinate) down to the lowest value, and the values of the same parameter for safe ships were entered on the right side by starting from the lowest and ending with the highest value. Thus, at the ordinate, the highest value of the parameter for casualty condition is next to the lowest value of the parameter for the safe case. In figure 15 an example diagram for righting levers comprising all ships analysed is shown. In the original analysis [IMO 1966, 1966a, 1985] diagrams were prepared separately for cargo and fishing vessels, but they are not reproduced here.

3.2.2.2.3 In the diagram (figure 15), the values for casualty condition are shaded, only those that have to be specially considered due to exceptional circumstances were left blank. On the right side of the ordinate the areas above the steps were shaded in order to make a distinction between the safe and unsafe cases easier. The limiting lines or the imaginary static stability lever curves were drawn in an identical way as in the Rahola diagram. Percentages of ships in arrival condition, the respective stability parameters which are below the limiting lines are shown in table 1. The lower percentages mean in general that there is better discrimination between safe and unsafe conditions.

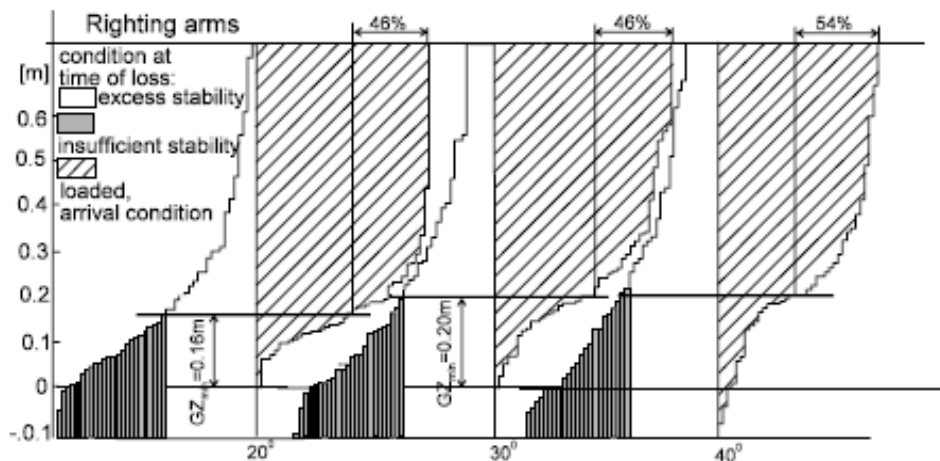

Figure 15 – Plot of righting levers for ships at time of casualty. Cargo vessels only. (IMO 1966, 1985)

Table 1 – Percentages of ships below limiting line

Stability parameter	Percentage		
	All ships	Cargo	Fishing
GZ_{20}	39	54	26
GZ_{30}	48	54	42
GZ_{40}	48	46	48
e	55	56	53

3.2.2.2.4 The type of analysis described above is not entirely rigorous; it was partly based on intuition and allows arbitrary judgement. Nevertheless, from the point of view of practical application, it provided acceptable results and finally was adopted as a basis for IMO stability criteria.

3.2.2.3 Discrimination Analysis

3.2.2.3.1 When two populations of data, as in this case, data for capsized ships and for ships considered safe, are available and the critical values of parameters from these two sets have to be obtained, the method of discrimination analysis may be applied.

3.2.2.3.2 The application of the discrimination analysis in order to estimate critical values of stability parameters were contained in a joint report by [IMO 1966, 1966a], and constituted the basis for development of IMO stability criteria along the previously described Rahola method.

3.2.2.3.3 In this investigation, discrimination analysis was applied independently to nine stability parameters. Using data from intact stability casualty records (group 1) and from intact stability calculations for ships considered safe in operation (group 2) the distribution functions were plotted, where for group 1 the distribution function F_1 and for group 2 function $(1 - F_2)$ were drawn. Practically, on the abscissa axis of the diagram, values for the respective stability parameter were plotted and the ordinates represent the number of ships in per cent of the total number of ships considered having the respective parameter smaller than the actual value for ships of group 1 and greater than the actual value for ships of group 2 considered safe.

3.2.2.3.4 The point of intersection of both curves in the diagram provides the critical value of the parameter in question. This value is dividing the parameters of group 1 and of group 2. In an ideal case, both distribution functions should not intersect and the critical value of the respective parameter is then at the point between two curves (see figure 16).

3.2.2.3.5 In reality, both curves always intersect and the critical value of the parameter is taken at the point of intersection. At this point, the percentage of ships capsized having the value of the respective parameter higher than the critical value is equal to the percentage of safe ships having the value of this parameter lower than the critical value.

3.2.2.3.6 The set of diagrams was prepared in this way for various stability parameters based on IMO statistics for cargo and passenger ships and for fishing vessels. One of the diagrams is reproduced in figure 17. It means that the probability of capsizing of a ship with the considered parameter higher than the critical value is the same as the probability of survival of a ship with this parameter lower than the critical value.

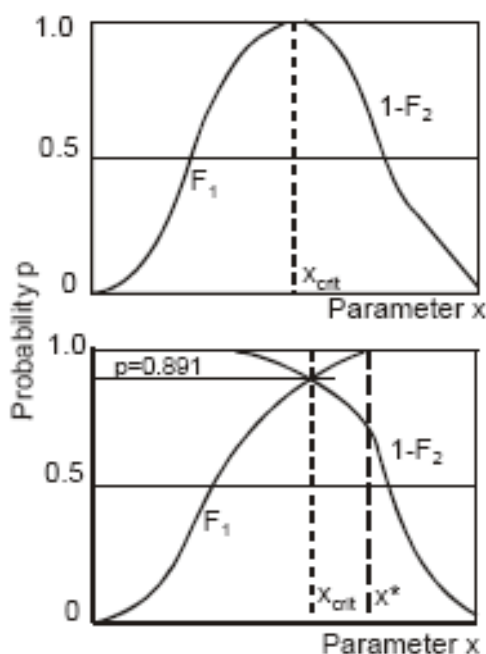

Figure 16 – Estimation of critical parameter.

3.2.2.3.7 In order to increase the probability of survival, the value of the parameter should be increased, say up to x^* (figure 16), at which the probability of survival (based on the population investigated) would be 100%. However, this would mean excessive severity of the criterion, which usually is not possible to adopt in practice because of unrealistic values of parameters obtained in this way curves do intersect could be explained in two ways. It is possible that ships of group 2 having values of the parameter in question $x < x_{crit}$ are unsafe, but they were lucky not to meet excessive environmental conditions which might cause capsizing. On the other hand, the conclusion could also be drawn that consideration of only one stability parameter is not sufficient to judge the stability of a ship.

3.2.2.3.8 The last consideration led to an attempt to utilize the IMO data bank for a discrimination analysis where a set of stability parameters was investigated [Krappinger and Sharma 1974]. The results of this analysis were, however, available after the SLF Sub-Committee had adopted criteria included in resolutions A.167(ES.IV) and A.168(ES.IV) and were not taken into consideration.

3.2.2.3.9 As can be seen from figure 17, the accurate estimation of the critical values of the respective parameters is difficult because those values are very sensitive to the running of the curves in the vicinity of the intersection point, especially if the population of ships is small.

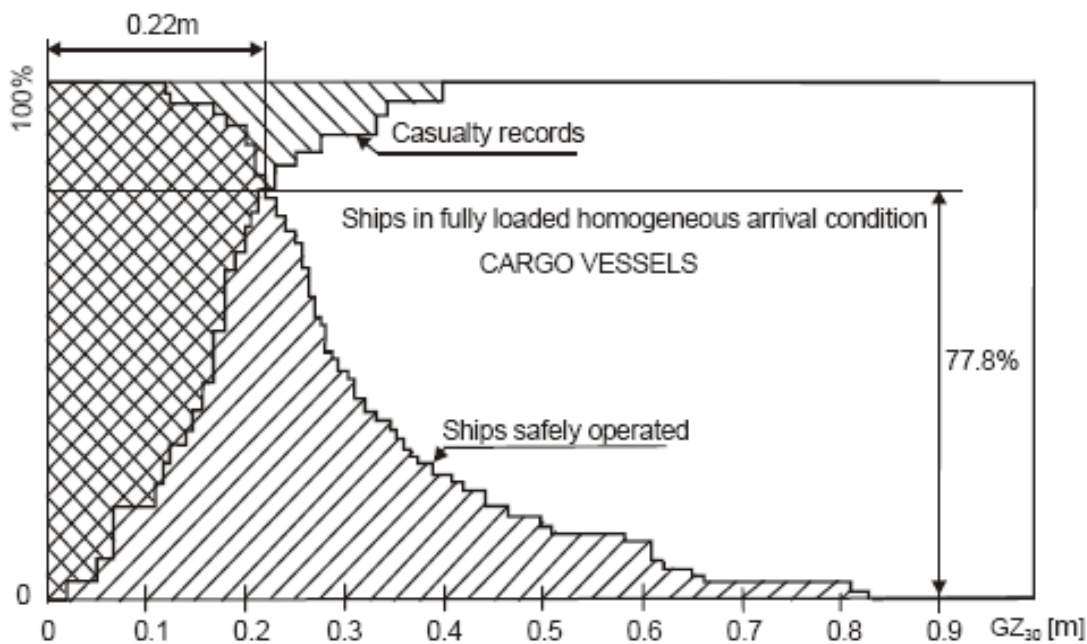

Figure 17 – Discrimination analysis for parameter GZ_{30} (IMO 1965)

3.2.2.4 Adoption of the final criteria and checking the criteria against a certain number of ships

3.2.2.4.1 The final criteria, as they were evaluated on the basis of the diagrams, are prepared in the form as shown in figures 15 and 17. The main set of diagrams did show righting lever curves (figure 15), but diagrams showing distribution of dynamic stability levers were also included. Diagrams were prepared jointly for cargo and passenger vessels and for fishing vessels, except vessels carrying timber deck cargo. Sets of diagrams were also separately prepared for cargo ships and fishing vessels. Diagrams in the form as shown in figure 17 were prepared separately for each stability parameter and separately for cargo and passenger ships and for fishing vessels.

3.2.2.4.2 After discussion by the Working Group on Intact Stability and the SLF Sub-Committee, the stability criteria were rounded off and finally adopted in the form as they appear in the resolutions A.167 (ES.IV) and A.168 (ES.IV).

3.2.2.4.3 In the original analysis the angle of vanishing stability was also included. However, due to the wide scatter of values of this parameter, it was not included in the final proposal.

3.2.2.4.4 As each criterion or system of criteria has to be checked against a sample of the population of existing ships, it was necessary to find the common basis for comparison results achieved with the application of different criteria. The most convenient basis for the comparison was the value of KG_{crit} that is the highest admissible value of KG satisfying the criterion or system of criteria, and the higher the value of KG_{crit} , the less severe the criterion.

3.2.2.4.5 As an example, criteria related to the righting lever curves could be written as:

$$GZ = KZ - KG \sin \phi \tag{1}$$

and

$$KG = \frac{KZ(\Delta, \phi) - GZ}{\sin \phi} \tag{2}$$

3.2.2.4.6 If for GZ and ϕ , values of respective criterion are inserted, values of KG_{crit} for respective displacement are obtained. Then the curve $KG_{crit} = f(\Delta)$ could be drawn. KG_{crit} could also be obtained graphically as shown in figure 18. It is possible to calculate values KG_{crit} also for dynamic criteria, although the method is more complicated.

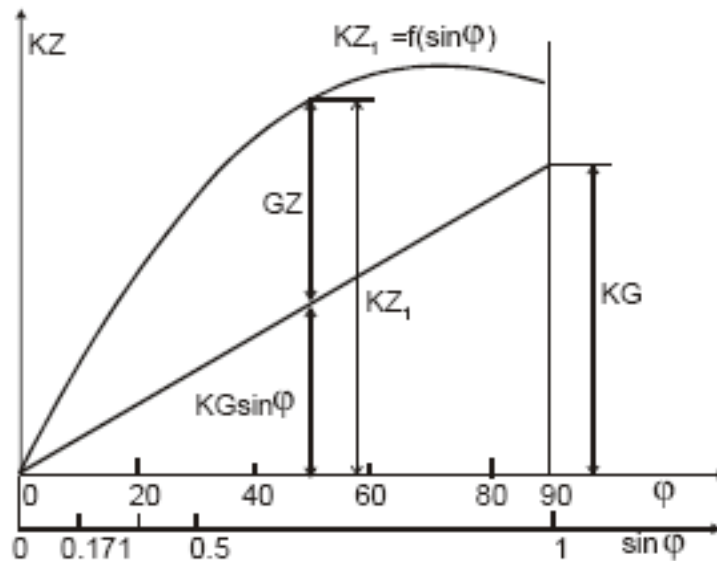

Figure 18 – Graphical estimation of KG_{crit}

3.2.2.4.7 Figure 19 shows the results of calculations of KG_{crit} for a fishing vessel ([IMO 1966]). Curves $KG_{crit} = f(\Delta)$ for 11 different criteria are plotted in the figure. By having such curves for each individual criterion, it is easy to determine critical KG curve for a system of criteria by drawing envelope.

3.2.2.4.8 Curves for KG_{crit} , as shown in figure 19, also allow conclusions to be drawn regarding the relative severity of various criteria or systems of criteria and to single out the governing one. If, in addition, actual values of KG for the particular ship are available, then it is possible to estimate whether the ship satisfies the criteria and which criterion leads to the condition most close to the actual condition. If it is assumed that ships in service are safe from the point of view of stability, it could be concluded which criterion or system of criteria fits in the best way without excessive reserve of stability.

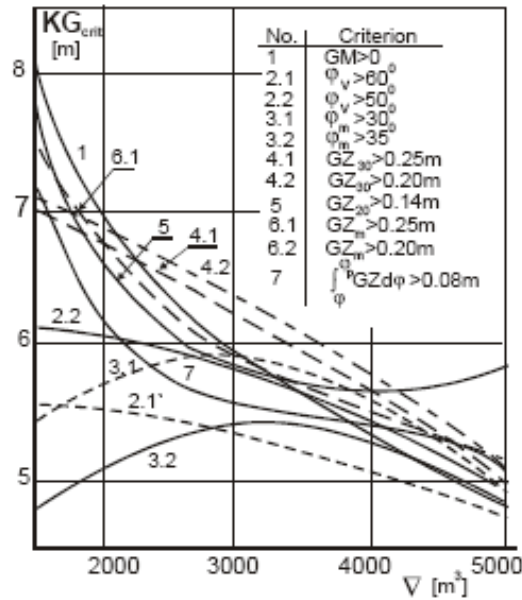

Figure 19 – Plot of the KG_{crit} curves for various criteria

3.2.2.4.9 With

$$k = \frac{KG_{actual}}{KG_{critical}}$$

a histogram of distribution of k is shown for the group of ships analysed (figure 20).

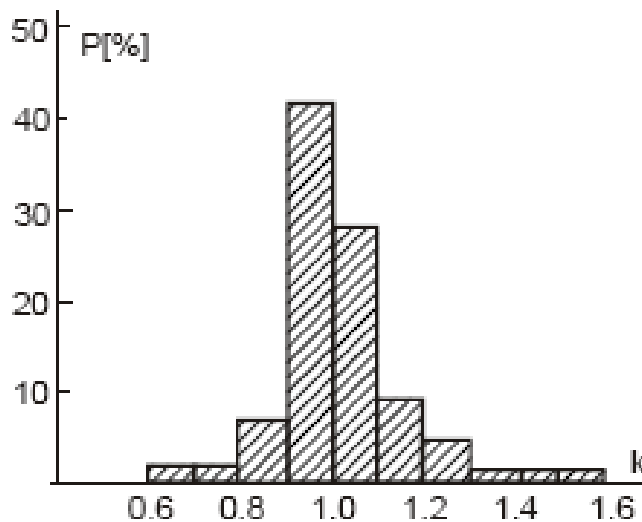

Figure 20 – Distribution of coefficient k for a group of ships analysed (Sevastianov 1968)

3.3 Background of the approximate formula for the minimum GM_0 for small fishing

vessels (part B, paragraph 2.1.5.1 of the 2008 IS Code)

3.3.1 The approximate formula for the minimum metacentric height for small fishing vessels was developed using the method of regression analysis. In 1967 the Panel of Experts on Fishing Vessels Stability (PFV) of IMO recommended to develop an appropriate stability standard for small fishing vessels less than 30 m in length. The reason for this was the fact that for small fishing vessels quite often no drawings and stability data are available; therefore, the application of criteria of resolution A.168 (ES IV) is not possible. It was proposed that a stability standard for those vessels could be developed in the form of a formula for GM_{crit} that could be compared with the actual GM_0 estimated on the basis of the rolling test. The value of GM_{crit} should correspond to the criteria of resolution A.168 (ES IV).

3.3.2 For the development of the appropriate formula, members of the Panel were requested to submit stability data for as many small fishing vessels as possible and also information regarding approximate formulae on GM_{crit} used in their countries, if any. Those formulae were later compared with the formulae developed by the regression analysis. The review of all approximate formulae revealed a rather wide scatter of values of GM_{crit} . This could be expected because it is obvious that the formulae do not take into account all parameters of the ship's hull that are important from the point of view of stability. Therefore, none of the formulae were adopted by IMO and it was decided to develop a new formula based on a regression analysis of a larger number of data for small fishing vessels.

3.3.3 The formula should provide results as close as possible to those provided by using IMO criteria included in resolution A.168 (ES IV). As it would be impossible to take into account all criteria, it was decided that the representative criterion which should be satisfied was $GZ_{30} = 0.20$ m.

3.3.4 Stability data was collected on 119 vessels of between 15 and 29 m in length and analysed [IMO 1968a].

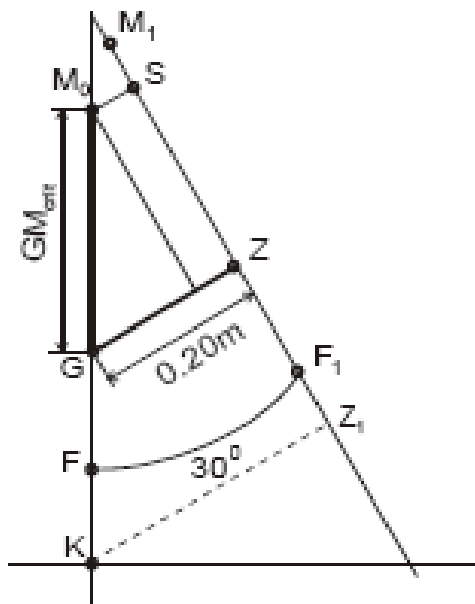

Figure 21 – Relation between GM_{crit} and $GZ = 0.20m$

3.3.5 As the condition for GM_{crit} is $GZ_{30} = 0.2$ m, the following is valid (figure 21):

$$GZ_{30} = GM_0 \sin 30^\circ + MS_{30} \tag{3}$$

then:

$$GM_{crit} = 0.40 - 2B \left(\frac{MS_{30}}{B} \right) \tag{4}$$

3.3.6 As MS_{30} depends only on geometrical parameters of the hull, this parameter might be **B**

used not only to evaluate GM_{crit} but also to compare different hull shapes from the stability point of view.

3.3.7 It is assumed that, in general, $\frac{MS_{30}}{B} = f \left\{ \frac{f}{B}, \frac{B}{D}, \frac{l_{sup}}{L} \right\}$

Polynomial expressions of different type were tested with coefficients evaluated by regression analysis. The evaluation of errors while estimating GM_{crit} of those expressions with respect to the actual GM_{crit} of the analysed vessels showed, as expected, that for about 50% of the vessels the calculated GM_{crit} was smaller than the actual value. For another 50% it was greater than the actual value (figure 22a) with the distribution of errors considered acceptable. To increase the safety, it was then decided that the calculated values of GM_{crit} should be increased by a certain amount, C_{GM} , in order to achieve a situation where about 85% of vessels were on the safe side (figure 22b). This supplementary C_{GM} was evaluated by an iteration process and it was determined that the proper value is $C_{GM} = 0.1250$.

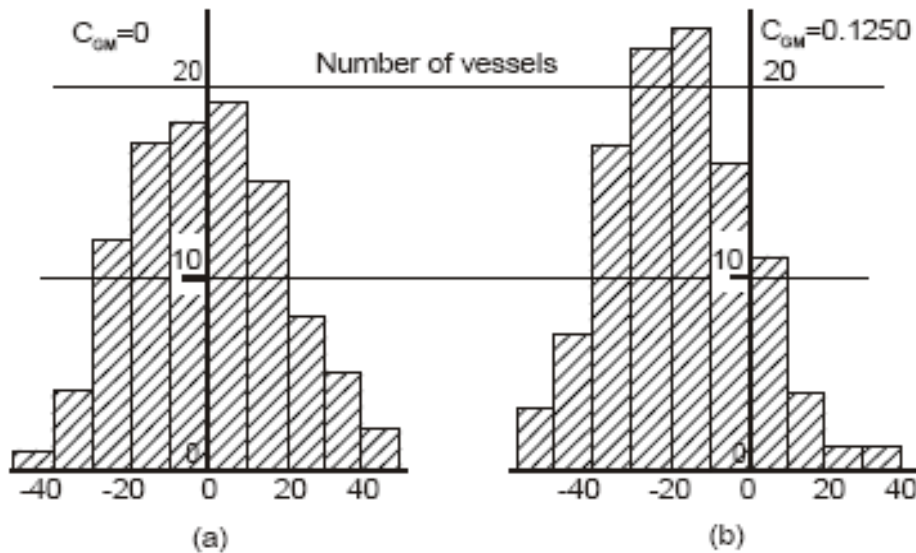

Figure 22 – Distribution of errors in estimation of GM_{crit} for small fishing vessels

3.3.8 The formula (4) was modified as follows:

$$GM_{crit} = 0.40 + C_{GM} - 2B \left(\frac{MS_{30}}{B} \right) \quad (5)$$

3.3.9 The final formula, as given in resolution A.207(VII), was:

$$GM_{crit} = 0.40 + C_{GM} - 2B \left[a_0 + a_1 \left(\frac{f}{B} \right) + a_2 \left(\frac{f}{B} \right)^2 + a_3 \left(\frac{B}{T} \right) + a_4 \left(\frac{l_{sup}}{L} \right) \right] \quad (6)$$

where:

C_{GM}	=	0.1250	a_2	=	- 0.8340
a_0	=	- 0.0745	a_3	=	0.0137
a_1	=	0.3704	a_4	=	0.0321

3.4 References relating to paragraphs 3.1 to 3.3

IMO, (1963). "Intact stability casualty record", *Document IS II/12*.

IMO, (1964). "Report on the national requirements for intact stability of ships", *Document IS III/3*.

IMO, (1965). "Analysis of intact stability casualty records", *Documents IS IV/11 and IS IV/14*.

IMO, (1966). "Analysis of intact stability casualty records of cargo and passenger vessels", *Document IS VI/3*.

IMO, (1966a). "Analysis of intact stability record of fishing vessels", *Document PFV IV/2*.

IMO, (1966b). "Analysis of intact stability casualty records of fishing vessels", *Document PFV IV/2/Add 1*.

IMO, (1967). "Analysis of the application of various stability criteria of fishing vessels. Part II", *Document PFV VI/24*.

IMO, (1968). "Analysis of simplified formulae for judgement of stability of fishing vessels", *Document PFV VI/8*.

IMO, (1968a). "Simplified stability criteria for decked fishing vessels under 30 m in length", *Documents PFV VIII/12 and PFV IX/4/1*.

IMO, (1968b). "Recommendation on intact stability for passenger and cargo ships under 100 metres in length", *resolution A.167(ES.IV)*.

IMO, (1968c). "Recommendation on intact stability of fishing vessels", *resolution A.168(ES.IV)*.

IMO, (1977a). "Intact stability criteria", *Document STAB XX (unofficial)*.

IMO, (1985). "Analysis of intact stability casualty records", *Documents SLF 30/4/4 and SLF/38*.

IMO, (1988). "Intact stability. Report of the ad hoc Working Group", *Document SLF 33/WP.8*.

- IMO, (1988a). "Report to the Maritime Safety Committee", *Document SLF 33/12*.
- IMO, (1990). "Draft code on intact stability for all types of ships covered in IMO instruments", *Document SLF 34/3/7*.
- IMO, (1993). Code on intact stability for all types of ships", *resolution A.749(18)*.
- Jens, J., Kobylinski, L., (1982). "IMO activities in respect of international requirements for the stability of ships". *Second International Conference on stability of ships and ocean vehicles, STAB'82, Tokyo*.
- Kobylinski, L. (1989). "Code of stability for all types of ships based on system approach", *International Conference PRADS 89, Varna, Bulgaria*.
- Kobylinski, L.K., Kastner, S., (2003). "Stability and Safety of Ships. Vol I: Regulation and Operation". *Elsevier Ocean Engineering Book Series, Vol.9, Elsevier*.
- Krappinger, O. and Sharma, S.D., (1974). "Sicherheit in der Schiffstechnik", *Transactions STG, Vol. 68*.
- Nadeinski, V.P. and Jens, J.E.L., (1968). "Stability of fishing vessels", *Transactions RINA*.
- Plaza, F., Petrov, A.A., (1986). "Further IMO activities in the development of international requirements for the stability of ships", *Third International Conference on stability of ships and ocean vehicles, STAB'86, Gdańsk*.
- Plaza, F., Semenov, V.Y., (1990). "Latest work of the International Maritime Organization related to stability of ships", *Fourth International Conference on stability of ships and ocean vehicles, STAB'90, Naples*.
- Rahola, J., (1935). "The judging of the stability of ships", *Transactions INA*.
- Rahola, J., (1939). "The judging of the stability of ships and the determination of the minimum amount of stability", *Ph.D. Thesis, Helsinki*.
- Thompson, G. and Tope, J.E., (1970). "International considerations of intact stability standards", *Transactions RINA, Vol. 112, pp. 43-67*.

3.5 Background of the severe wind and rolling criterion (weather criterion)

3.5.1 Introduction

3.5.1.1 The severe wind and rolling criterion (weather criterion) is one of general provisions of the 2008 IS Code. This criterion was originally developed to guarantee the safety against capsizing for a ship losing all propulsive and steering power in severe wind and waves, which is known as a dead ship. Because of no forward velocity of ships, this assumes an irregular beam wind and wave condition. Thus operational aspects of stability are separated from this criterion, and are dealt with the guidance to the master for avoiding dangerous situation in following and quartering seas (MSC/Circ.707), in which a ship could capsize more easily than beam seas under some operational actions.

3.5.1.2 The weather criterion firstly appeared in the IMO instruments as Attachment No.3 to the Final Act of Torremolinos International Convention for the Safety of Fishing Vessels, 1977. During the discussion for developing the Torremolinos Convention, the limitation of the GZ curve criterion based on resolution A.168(ES.IV) was remarked; it is based on experiences of fishing vessels only in limited water areas and it has no way for extending its applicability to other ship types and other weather conditions. Thus, other than the GZ curve criterion, the Torremolinos Convention adopted the severe wind and rolling criterion including a guideline of calculation. This new provision is based on the Japanese stability standards for passenger ships (Tsuchiya, 1975; Watanabe *et al.*, 1956).

3.5.1.3 Then, a similar criticism to the GZ curve criterion for passenger and cargo ships, resolution A.167(ES.IV), was raised at IMCO. At least resolution A.167 was claimed to be applicable to ships of 100 m in length or below because of the limitation of statistical data source. As a result, a weather criterion was adopted also for passenger and cargo ships as well as fishing vessels of 45 m in length or over, as given in resolution A.562(14) in 1985. This new criterion keeps the framework of the Japanese stability standard for passenger ships but includes USSR's calculation formula for roll angle. For smaller fishing vessels, resolution A.685(17) in 1991 was passed. Here the reduction of wind velocity near sea surface is introduced reflecting USSR's standard. When the IS Code was established as resolution A.749(18) in 1993, all the above provisions were superseded.

3.5.2 Energy Balance Method

3.5.2.1 The basic principle of the weather criteria is energy balance between the beam wind heeling and righting moments with a roll motion taken into account. One of the pioneering works on such energy balance methods can be found in Pierrottet (1935) (figure 23). Here, as shown in figure 3.1, the energy required for restoring is larger than that required for the wind heeling moment. Since no roll motion is taken into account, a ship is assumed to suddenly suffer a wind heeling moment at its upright condition. This was later used in the interim stability requirements of the USSR and then Poland, Rumania, GDR and China (Kobylnski & Kastner, 2003).

3.5.2.2 In Japan the energy balance method is extended to cover a roll motion and to distinguish steady and gusty wind as shown in figure 24. Then it is adopted as the basic principle of Japan's national standard (Watanabe *et al.*, 1956). The regulation of the Register of Shipping of the USSR (1961) also assumes initial windward roll angle as shown in figure 24. The current IMO weather criterion of chapter 2.3 of the IS Code, part A, utilizes the energy balance method adopted in Japan without major modification. Here we assume that a ship with a steady heel angle due to steady wind has a resonant roll motion in beam waves. Then, as a worst case, the ship is assumed to suffer gusty wind when she rolls toward windward. In the case of the resonant roll, roll damping moment and wave exciting moment cancel out. Thus, the energy balance between restoring and wind heeling energy can be validated around the upright condition. Furthermore, at the final stage of capsizing, since no resonance mechanism exists near the angle of vanishing stability, the effect of wave exciting moment could be approximated to be small (Belenky, 1993).

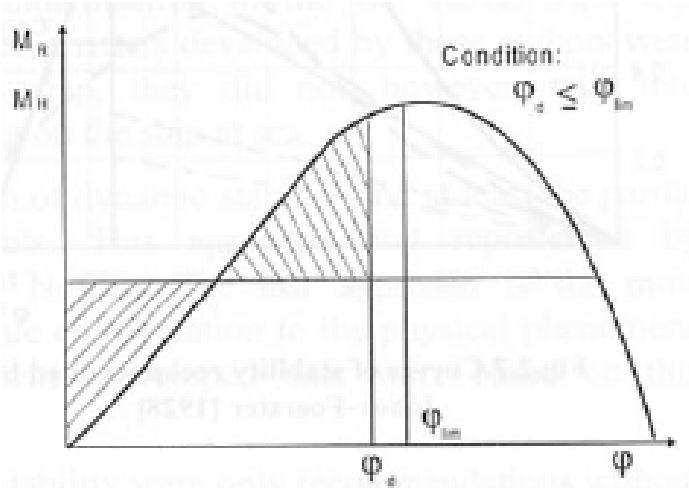

Figure 23 – Energy balance method used by Pierrottet (1935)

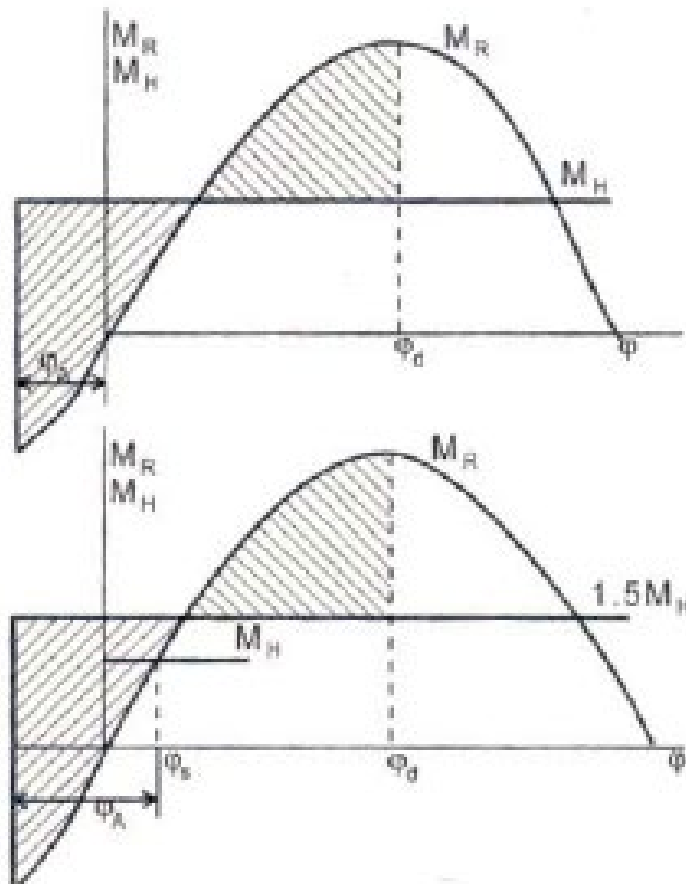

Figure 24 – Energy balance methods in standards of USSR (upper) and Japan (lower) (Kobylinski & Kastner, 2003)

3.5.3 Wind heeling moment

3.5.3.1 In the Japanese standard the steady heeling moment, M_w , is expressed as follows:

$$M_w = \frac{1}{2} \rho C_D A H_0 (H / H_0) V_w^2 \tag{1}$$

where:

- ρ = air density
- C_D = drag coefficient
- A = lateral windage area above water surface
- H = heeling lever
- H_0 = vertical distance from centre of lateral windage area to a point at one half the mean draught
- V_w = wind velocity

3.5.3.2 Values of C_D obtained from experiments of passenger ships and train ferries ranges from 0.95 to 1.28. In addition, a wind tunnel test for a domestic passenger ship (Okada, 1952) shows that H/H_0 is about 1.2. Considering these data, the value of $C_D(H/H_0)$ was assumed to be 1.22 on average. These formula and coefficients were adopted also at IMO.

3.5.3.3 To represent fluctuating wind, gustiness should be determined. Figure 25 shows the ratio of gustiness measured in various stormy conditions. (Watanabe *et al.*, 1955). Here the maximum

is 1.7 and the average is $\sqrt{1.5} (\approx 1.23)$. However, these were measured for about 2 hours of duration but capsizing could happen within half the roll natural period, say 3 to 8 seconds. In addition, reaction force could act on centre of ship mass because of such short duration. Therefore, in place of the maximum value, the average value of figure 25 is adopted. This results in 1.5 as heeling lever ratio for gustiness as shown in the 2008 IS Code.

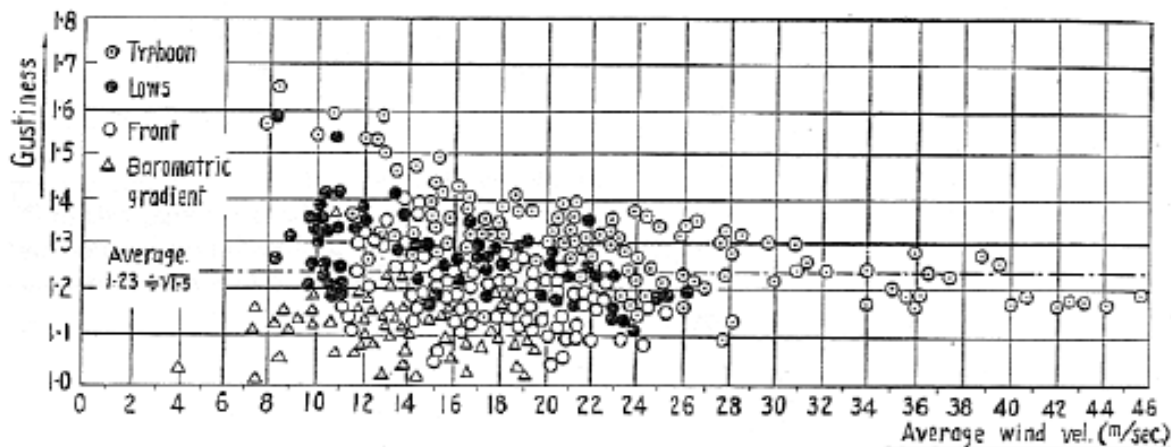

Figure 25 – Gustiness of measured sea wind (Watanabe *et al.*, 1956)

3.5.4 Roll angle in waves (Japanese Method)

In general, ship motion consists of surge, sway, heave, roll, pitch and yaw. In beam seas, however, only sway, heave and roll are dominant. Furthermore, the effect of heave on roll is negligibly small and coupling from sway to roll can be cancelled with roll diffraction moment (Tasai & Takagi, 1969). Therefore, the roll motion can be modelled without coupling from other motion modes if the wave exciting moment is estimated without wave diffraction. Consequently, considering nonlinear roll damping effect is taken into account, the amplitude of resonant roll in regular beam waves, Φ (degrees), can be obtained as follows:

$$\phi = \sqrt{\frac{\pi \Theta}{2N(\phi)}} \tag{2}$$

where:

- $\Theta (= 180 \times s)$ = maximum wave slope (degrees)
- s = wave steepness
- r = effective wave slope coefficient
- N = Bertin's roll damping coefficient as a function of roll amplitude.

3.5.4.1 Wave steepness

Based on observations at sea, Sverdrup and Munk (1947) published a relationship between wave age and wave steepness as shown in figure 26. Here the wave age is defined with the ratio of wave phase velocity, u , to wind velocity, v , and wave height, H_w , means significant wave height. If we use the dispersion relationship of water waves, $u = gT / 2 \pi$, this diagram can be converted to that with wave period, T , as shown in figure 27. Further, since the ship suffers a resonant roll motion, the wave period could be assumed to be equal to the ship natural roll period. Here it is noteworthy that the obtained wave steepness is a function of roll period and wind velocity. In addition, because of possible spectrum of ocean waves, regions for the maximum and minimum steepness are modified from the original data.

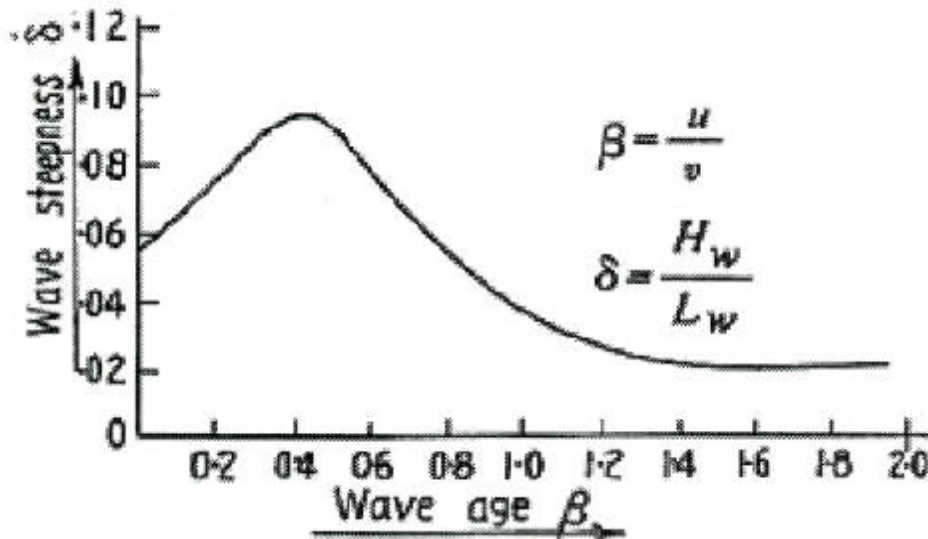

Figure 26 – Relationship between wave age and wave steepness (Sverdrup & Munk, 1947)

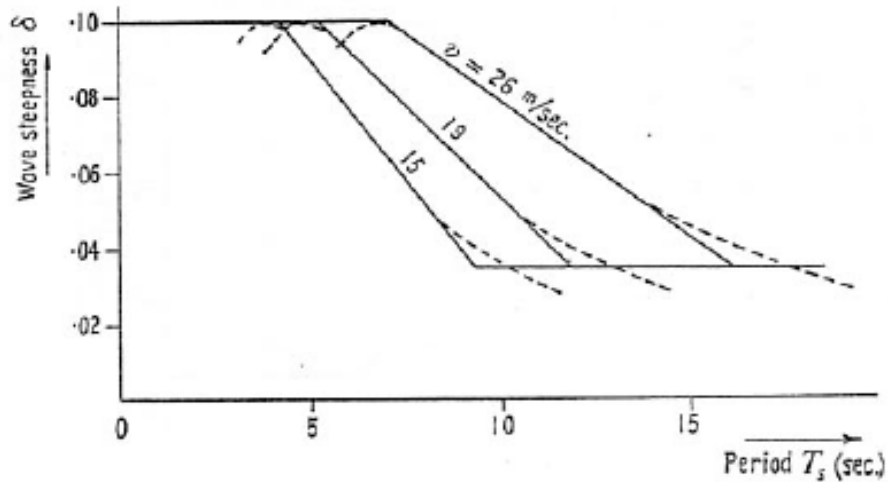

Figure 27 – Relationship between roll period and wave steepness in Japanese criterion (Yamagata, 1959)

3.5.4.2 Hydrodynamic coefficients

For using Equation (2), it is necessary to estimate the values of r and N . Since we should estimate wave exciting moment without wave diffraction due to a ship, it can be obtained by integrating undisturbed water pressure over the hull under calm water surface. Watanabe (1938) applied this method to several ships and developed an empirical formula, which is a function of wave length, VCG, GM, breadth, draught, block coefficient and water plane area coefficient. For simplicity sake, it is further simplified for 60 actual ships only as a function of VCG and draught shown in figure 28. The formula used in the IMO weather criterion for r was obtained by this procedure.

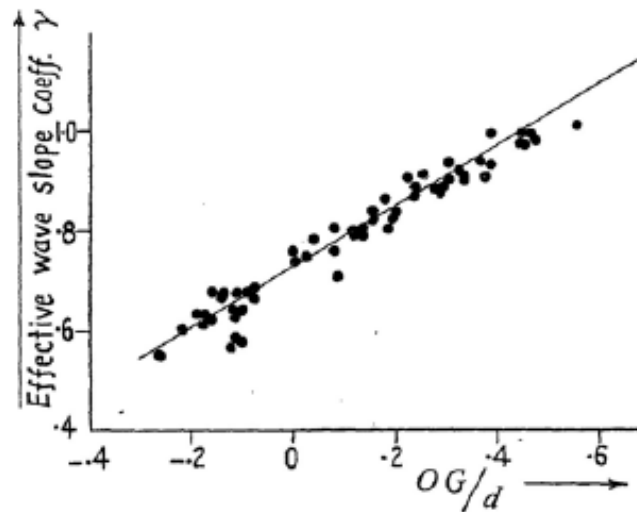

Figure 28 – Effective wave slope coefficient: measurements (circles) and estimation (solid line) (Yamagata, 1959)

For estimating the N coefficient, several empirical formulae were available. However, in the Japanese stability standards, $N=0.02$ is recommended for a ship having bilge keels at the roll angle of 20° . Some evidence of this value can be found in figure 29 (Matora, 1957).

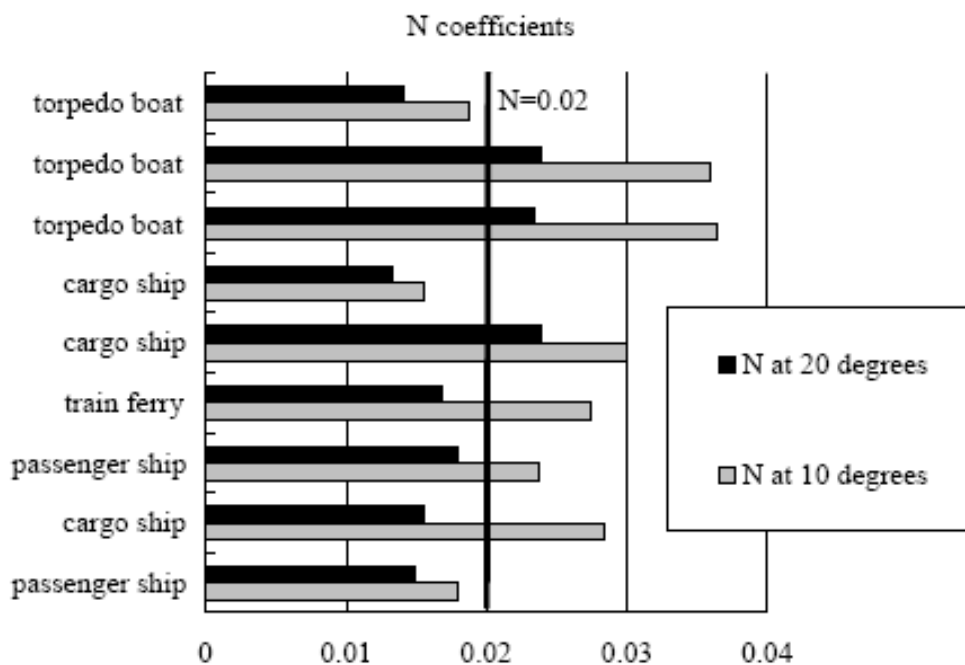

Figure 29 – Example of N coefficients measured in model experiments

3.5.4.3 Natural roll period

For calculating the wave steepness, it is necessary to estimate the natural roll period for a subject ship. In the Japanese standard, the value measured with the actual ship is corrected with Kato's empirical formula (Kato, 1956). However, at the STAB Sub-Committee, this procedure was regarded as tedious and Japan was requested to develop a simple and updated empirical formula for the roll period. Thus the current formula was statistically developed by Morita, and is based on data measured from 71 full-scaled ships in 1982. As shown in figure 30, all sampled data exist within $\pm 7.5\%$ of error from Morita's formula. More precisely, the standard deviation of the error from the formula is 1.9%. Furthermore, sensitivity analysis of C on required GM indicated that even 20% error of C estimation results in only 0.04 m error of required GM calculation. Therefore, IMO concluded that this formula can be used for weather criteria.

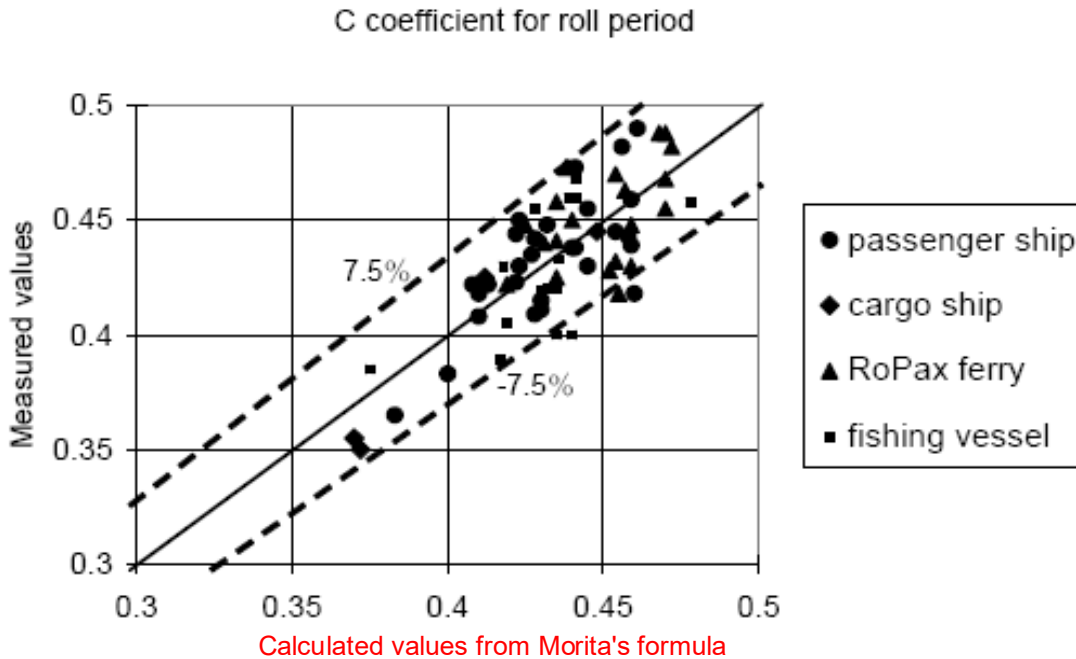

Figure 30 – Estimation accuracy for empirical formula for roll period

3.5.4.4 Wave randomness

While the wave steepness obtained from Sverdrup-Munk's diagram is defined by the significant wave height in irregular waves, the resonant roll amplitude given by Equation (2) is formulated for regular waves. For filling the gap between two, the roll amplitude in irregular waves whose significant wave height and mean wave period are equal to height and period of regular waves was compared with the resonant roll amplitude in the regular waves. As shown in figure 31, if we focus the maximum amplitude out of 20 to 50 roll cycles, an obtained reduction factor is 0.7.

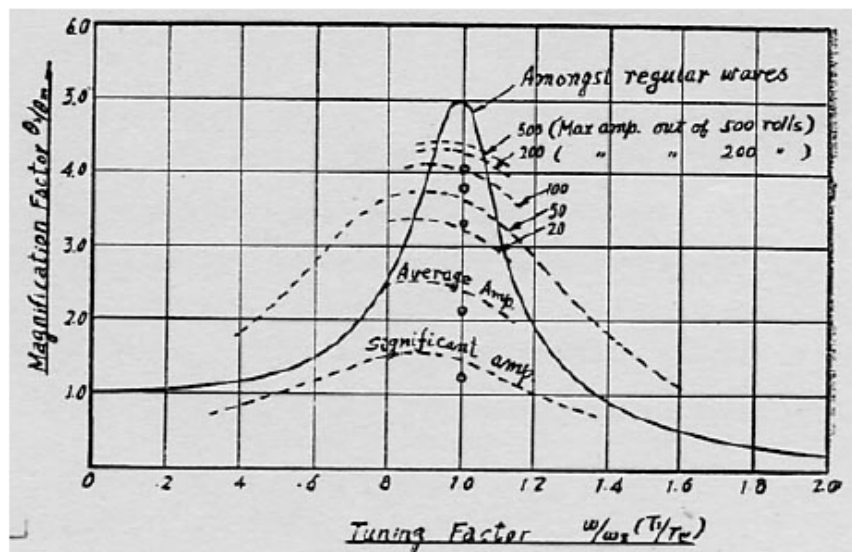

Figure 31 – Comparison of roll amplitude in regular and irregular waves (Watanabe et al., 1956)

3.5.4.5 Steady wind velocity

As explained above, the Japanese weather criterion introduced probabilistic assumptions for determining gust and roll in irregular waves. These make the final probabilistic safety level unclear. Possible estimation errors for wind heel lever coefficient roll damping coefficient, effective wave slope coefficient, natural roll period and wave steepness all added uncertainty to the required safety level. Therefore, Japan carried out test calculations for 50 ships, which include 13 ocean going ships as shown in figure 32. Based on these calculated outcomes, the steady wind velocity was determined to distinguish ships having insufficient stability from other ships. In other words, for ships having insufficient stability the energy balance should not be obtained with the above procedure. As a result, the wind velocity for ocean going ships is determined as 26 m/s. Here a sunken torpedo boat (O-12-I), a sunken destroyer (O-13) and three passenger ships having insufficient stability (O-3, 7, and 9) are categorized as unsafe and 2 cargo ships, 3 passenger ships and 3 larger passenger ships are done as safe. It is noteworthy here that 26 m/s of wind velocity is only obtained from casualty statistics for ships and is not directly obtained from actual wind statistics. IMO also adopted 26 m/s as critical wind velocity. If we substitute $V_w=26$ m/s to Equation (1), the wind pressure in the current IS Code is obtained.

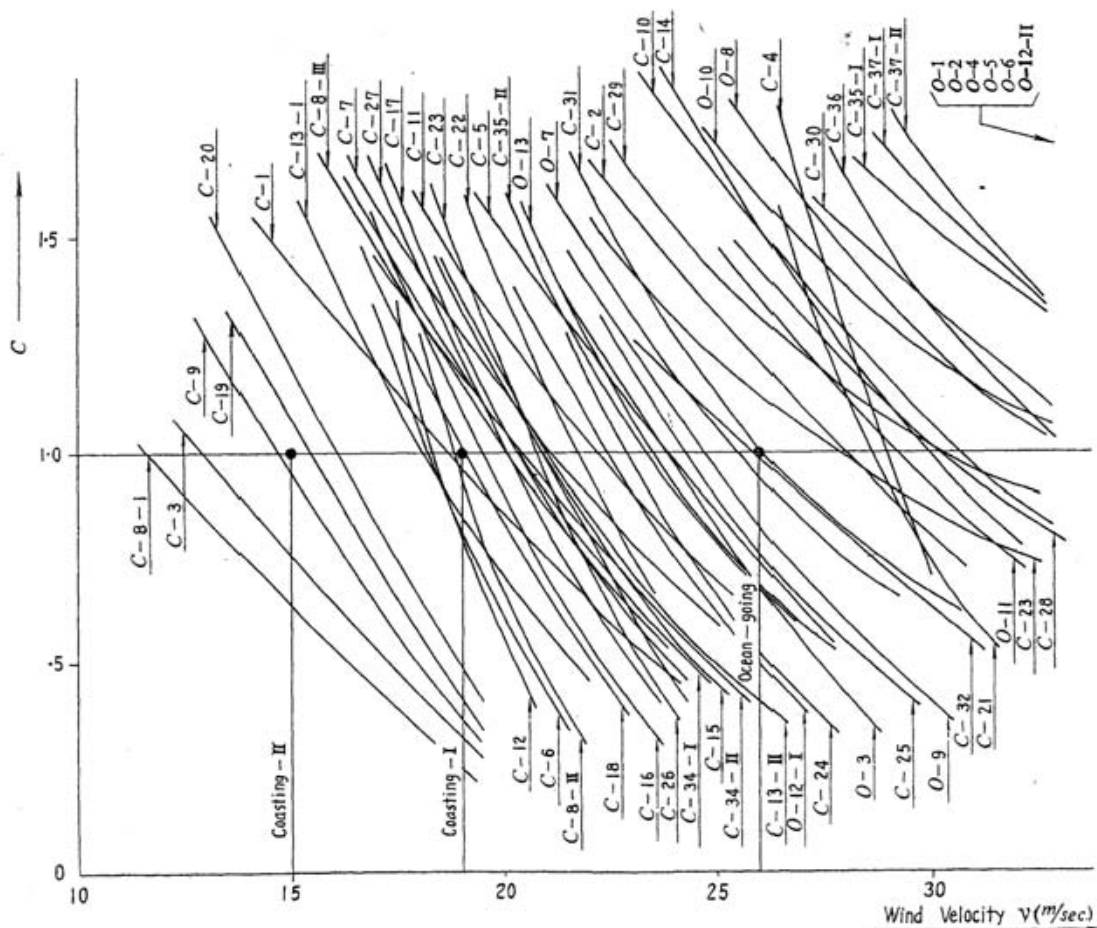

Figure 32 – Results of test calculations for determining steady wind velocity. Relation between wind velocity and the b/a factor for various sample ships (Watanabe et al., 1956)

3.5.4.6 Rolling in waves (USSR's method)

In the stability standard of USSR (USSR, 1961), the maximum roll amplitude of 50 roll cycles is estimated as follows:

$$\phi_R = kX_1X_2\phi_A \tag{3}$$

Here k is a function of bilge keel area, X_1 is a function of B/d , X_2 is a function of the block coefficient and ϕ_A is the roll amplitude of the standard ship, which is shown in figure 33. This formula was developed by systematic calculations for a series of ships utilizing the transfer function and wave spectrum (Kobylnski & Kastner, 2003).

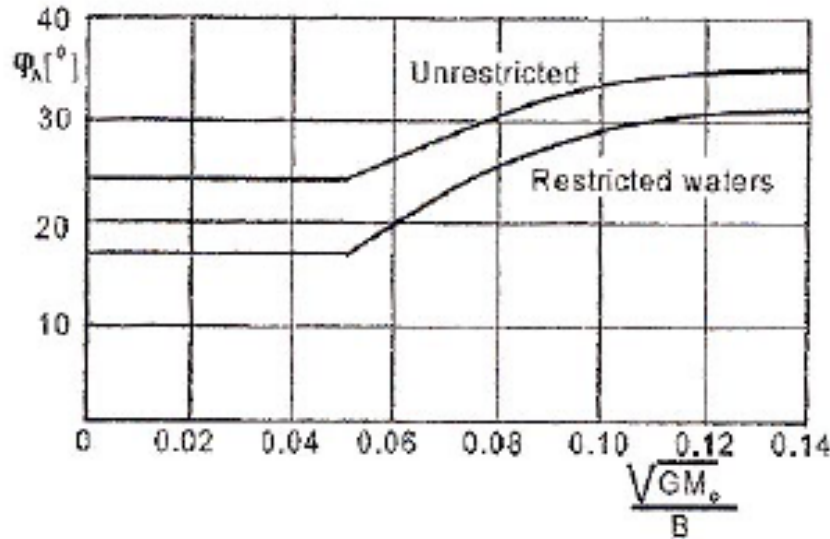

Figure 33 – Standard roll amplitude in USSR's criterion (USSR, 1961)

As mentioned earlier, IMO decided to partly use this USSR's roll formula together with the Japanese criterion. This is because the USSR's formula depends on hull forms for estimating roll damping while the Japanese does not. The proposed formula is as follows:

$$\phi_1(\text{degrees}) = C_{JR}kX_1X_2\sqrt{rs} \tag{4}$$

Here C_{JR} is a tuning factor for keeping the safety level of the new criterion as the same as the Japanese domestic standard. To determine this factor, member states of a working group of STAB Sub-Committee executed test calculations of Japanese and new formulations for many ships. For example, Japan (1982) executed test calculation for 58 ships out of 8,825 Japanese flagged-ships larger than 100 gross tonnage in 1980. These include 11 cargo ships, 10 oil tankers, 2 chemical tankers, 5 liquid gas carriers, 4 container ships, 4 car carriers, 5 tug boats and 17 passenger or RoPax ships. As a result, IMO concluded that C_{JR} should be 109.

3.6 References relating to paragraph 3.5

- Belenky, V.L., (1993). *Capsizing Probability Computation Method*, Journal of Ship Research, 37(3): 200-207.
- Japan, (1982). *Weather Criteria, Results on Japanese Ships*, SLF/7.
- Kato, H., (1956). *On a Method for Calculating an Approximate Value of the Rolling Period of Ships*, Journal of Society of Naval Architects of Japan, Vol. 89.
- Kobylnski, L.K. and S. Kastner, (2003). *Stability and Safety of Ships*, Elsevier (Oxford, UK), Vol. 1.
- Motora, S., (1957). *Ship Dynamics*, Kyoritsu Publications (Tokyo).
- Okada, S., (1952). *On the Heeling Moment due to Wind Pressure on Small Vessels*, Journal of Society of Naval Architects of Japan, Vol. 92: 75-81.
- Pierrottet, E., (1935). *A Standard of Stability for Ships*, Transaction of the Institution of Naval Architects, p. 208.
- Sverdrup, H.U. and W.H. Munk, (1947). *Wind, Sea and Swell, Theory of Relations for Forecasting*, Hydrographic Office Publication No. 601.
- Tasai, F. and M. Takagi, (1969). *Theory and Calculation Method for Response in Regular Waves*, Seakeeping Symposium, Society of Naval Architects of Japan, p.40.
- Tsuchiya, T., (1975). *An Approach for Treating the Stability of Fishing Boats*, Proceedings of International Conference on Stability of Ships and Ocean Vehicles, University of Strathclyde, 5.3:1-9.
- USSR, (1961). *Standards of Stability of Sea-Going Vessels and Coasters*, Register of Shipping of the USSR, Mosrskoi Transport, Moscow. Also available in IMCO STAB/77, USSR (1979)
- Watanabe, Y., (1938). *Some Contributions to the Theory of Rolling*, Transaction of the Institution of Naval Architects, 80:408-432.
- Watanabe, Y. *et al.*, (1955). *Report of the Ocean Wind about Japan on the Naval-Architectural Point of View.*, Journal of Society of Naval Architects of Japan, Vol. 96: 37-42.
- Watanabe, Y. *et al.*, (1956). *A Proposed Standard of Stability for Passenger Ships (Part III: Ocean-going and Coasting Ships)*, Journal of Society of Naval Architects of Japan, Vol. 99: 29-46.
- Yamagata, M., (1959). *Standard of Stability Adopted in Japan*, Transactions of the Institution of Naval Architects, 101:417-443.

Explanatory Notes Chapter 4 - Guidance for the application of the 2008 IS Code**4.1 Criteria regarding righting lever curve properties**

For certain ships the requirement contained in paragraph 2.2.3 of part A of the Code may not be practicable. Such ships are typically of wide beam and small depth, indicatively $B/D \geq 2.5$. For such ships the MCA may apply the following alternative criteria:

- .1 the maximum righting lever (GZ) should occur at an angle of heel not less than 15° ; and
- .2 the area under the curve of righting levers (GZ curve) should not be less than 0.070 metre-radians up to an angle of 15° when the maximum righting lever (GZ) occurs at 15° and 0.055 metre-radians up to an angle of 30° when the maximum righting lever (GZ) occurs at 30° or above. Where the maximum righting lever (GZ) occurs at angles of between 15° and 30° , the corresponding area under the righting lever curve should be:
 $0.055 + 0.001 (30^\circ - \varphi_{\max})$ metre-radians^{*}

* φ_{\max} is the angle of heel in degrees at which the righting lever curve reaches its maximum.

**MSC Resolutions and Circulars relevant to IS Code, Explanatory Notes,
Updates and Forthcoming Amendments****RESOLUTION MSC.267(85)
(adopted on 4 December 2008)****ADOPTION OF THE INTERNATIONAL CODE ON INTACT STABILITY, 2008
(2008 IS CODE)**

THE MARITIME SAFETY COMMITTEE,

RECALLING Article 28(b) of the Convention on the International Maritime Organization concerning the functions of the Committee,

RECALLING ALSO resolution A.749(18) entitled “Code on Intact Stability for All Types of Ships Covered by IMO Instruments”, as amended by resolution MSC.75(69),

RECOGNIZING the need to update the aforementioned Code and the importance of establishing mandatory international intact stability requirements,

NOTING resolutions MSC.269(85) and MSC.270(85), by which it adopted, *inter alia*, amendments to the International Convention for the Safety of Life at Sea, 1974, as amended (hereinafter referred to as “the 1974 SOLAS Convention”) and to the Protocol of 1988 relating to the International Convention on Load Lines, 1966, (hereinafter referred to as “the 1988 Load Lines Protocol”), respectively, to make the introduction and the provisions of part A of the International Code on Intact Stability, 2008 mandatory under the 1974 SOLAS Convention and the 1988 Load Lines Protocol,

HAVING CONSIDERED, at its eighty-fifth session, the text of the proposed International Code on Intact Stability, 2008,

1. ADOPTS the International Code on Intact Stability, 2008 (2008 IS Code), the text of which is set out in the Annex to the present resolution;
2. INVITES Contracting Governments to the 1974 SOLAS Convention and Parties to the 1988 Load Lines Protocol to note that the 2008 IS Code will take effect on 1 July 2010 upon the entry into force of the respective amendments to the 1974 SOLAS Convention and 1988 Load Lines Protocol;
3. REQUESTS the Secretary-General to transmit certified copies of the present resolution and the text of the 2008 IS Code contained in the Annex to all Contracting Governments to the 1974 SOLAS Convention and Parties to the 1988 Load Lines Protocol;
4. FURTHER REQUESTS the Secretary-General to transmit copies of this resolution and the Annex to all Members of the Organization which are not Contracting Governments to the 1974 SOLAS Convention and Parties to the 1988 Load Lines Protocol;
5. RECOMMENDS Governments concerned to use the recommendatory provisions contained in part B of the 2008 IS Code as a basis for relevant safety standards, unless their national stability requirements provide at least an equivalent degree of safety.

INTERNATIONAL MARITIME ORGANIZATION
4 ALBERT EMBANKMENT
LONDON SE1 7SR

Telephone: 020 7735 7611
Fax: 020 7587 3210



E

Ref. T1/2.03

MSC.1/Circ.1281
9 December 2008

EXPLANATORY NOTES TO THE INTERNATIONAL CODE ON INTACT STABILITY, 2008

1 The Maritime Safety Committee, at its eighty-fifth session (26 November to 5 December 2008), adopted, by resolution MSC.267(85), the International Code on Intact Stability, 2008 (2008 IS Code). In adopting the 2008 IS Code, the Committee recognized the necessity of appropriate explanatory notes to ensure uniform interpretation and application.

2 To this end, the Committee approved the Explanatory Notes to the Intact Stability Code, 2008, set out in the annex, as prepared by the Sub-Committee on Stability and Load Lines and on Fishing Vessels Safety at its fiftieth session (30 April to 4 May 2007).

3 The Explanatory Notes are intended to provide Administrations and the shipping industry with specific guidance to assist in the uniform interpretation and application of the intact stability requirements of the 2008 IS Code.

4 Member Governments are invited to use the Explanatory Notes when applying the intact stability requirements of the 2008 IS Code adopted by resolution MSC.267(85) and to bring them to the attention of all parties concerned.

INTERNATIONAL MARITIME ORGANIZATION
4 ALBERT EMBANKMENT
LONDON SE1 7SR

Telephone: 020 7735 7611
Fax: 020 7587 3210

**E**

Ref. T1/2.03

MSC.1/Circ.1292
9 December 2008

EARLY APPLICATION OF THE INTERNATIONAL CODE ON INTACT STABILITY, 2008

1 The Maritime Safety Committee, at its eighty-fifth session (26 November to 5 December 2008), adopted the International Code on Intact Stability, 2008 (2008 IS Code) by resolution MSC.267(85), together with adoption of amendments to chapter II-1 of the International Convention for the Safety of Life at Sea, 1974, as amended (1974 SOLAS Convention) (resolution MSC.269(85)) and to the Protocol of 1988 relating to the International Convention on Load Lines, 1966 (1988 LL Protocol) (resolution MSC.270(85)), in order to make the introduction and the provisions of part A of the 2008 IS Code mandatory under the Convention and the Protocol, which are expected to enter into force on 1 July 2010.

2 In adopting the aforementioned amendments, the Committee considered the recommendation by the Sub-Committee on Stability and Load Lines and on Fishing Vessels Safety, at its fifty-first session, that Contracting Governments to the 1974 SOLAS Convention and Parties to the 1988 LL Protocol may apply, in advance, the provisions of the 2008 IS Code before it has entered into force, and agreed to the recommendation.

3 The Committee, therefore, resolved that Contracting Governments to the 1974 SOLAS Convention and Parties to the 1988 LL Protocol may apply the 2008 IS Code in advance of the entry into force of the amendments to chapter II-1 of the 1974 SOLAS Convention and the 1988 LL Protocol that make the introduction and the provisions of part A of the 2008 IS Code mandatory.

4 Contracting Governments to the 1974 SOLAS Convention and Parties to the 1988 LL Protocol are invited to take account of this decision when surveying and certifying ships flying their flag constructed on or after 5 December 2008.

RESOLUTION MSC.319(89)
(adopted on 20 May 2011)

**AMENDMENTS TO PART B OF THE INTERNATIONAL
CODE ON INTACT STABILITY, 2008 (2008 IS CODE)**

THE MARITIME SAFETY COMMITTEE,

RECALLING Article 28(b) of the Convention on the International Maritime Organization concerning the functions of the Committee,

RECALLING ALSO resolution MSC.267(85) by which it adopted the International Code on Intact Stability, 2008 (2008 IS Code),

NOTING the provisions regarding the procedure for amendments to part B (recommendatory part) of the 2008 IS Code, stipulated in paragraph 27.2 of regulation II-1/2 of the International Convention for the Safety of Life at Sea (SOLAS), 1974 (1974 SOLAS Convention), as amended by resolution MSC.269(85), and in paragraph (16).2 of regulation I/3 of the Protocol of 1988 relating to the International Convention on Load Lines, 1966 (1988 Load Lines Protocol), as amended by resolution MSC.270(85),

RECOGNIZING the need to include a reference to the Code for the Construction and Equipment of Mobile Offshore Drilling Units, 2009 (2009 MODU Code) in the 2008 IS Code,

HAVING CONSIDERED, at its eighty-ninth session, the proposed amendments to part B of the 2008 IS Code, prepared by the Sub-Committee on Stability and Load Lines and on Fishing Vessels Safety, at its fifty-second session,

1. ADOPTS amendments to part B of the 2008 IS Code, the text of which is set out in the Annex to the present resolution;
2. RECOMMENDS Governments concerned to use the amendments to part B of the 2008 IS Code as a basis for relevant safety standards, unless their national stability requirements provide at least an equivalent degree of safety;
3. INVITES Contracting Governments to the 1974 SOLAS Convention and Parties to the 1988 Load Lines Protocol to note that the above amendments to the 2008 IS Code will take effect on 20 May 2011.

[This relates to replacing section 2.6 in Part B chapter 2.](#)

RESOLUTION MSC.398(95)
(adopted on 5 June 2015)

**AMENDMENTS TO PART B OF THE INTERNATIONAL
CODE ON INTACT STABILITY, 2008 (2008 IS CODE)**

THE MARITIME SAFETY COMMITTEE,

RECALLING Article 28(b) of the Convention on the International Maritime Organization concerning the functions of the Committee,

RECALLING ALSO resolution MSC.267(85) by which it adopted the International Code on Intact Stability, 2008 (2008 IS Code),

NOTING the provisions regarding the procedure for amendments to part B (recommendatory part) of the 2008 IS Code, stipulated in paragraph 27.2 of regulation II-1/2 of the International Convention for the Safety of Life at Sea (SOLAS), 1974 (1974 SOLAS Convention), as amended by resolution MSC.269(85), and in paragraph (16).2 of regulation I/3 of the Protocol of 1988 relating to the International Convention on Load Lines, 1966 (1988 Load Lines Protocol), as amended by resolution MSC.270(85),

RECOGNIZING the need to include provisions regarding ice accretion on cargo ships carrying timber deck cargoes in the 2008 IS Code,

HAVING CONSIDERED, at its [ninety-fifth session], the proposed amendments to part B of the 2008 IS Code, prepared by the Sub-Committee on Ship Design and Construction, at its second session,

1 ADOPTS amendments to part B of the 2008 IS Code, the text of which is set out in the annex to the present resolution;

2 RECOMMENDS Governments concerned to use the amendments to part B of the 2008 IS Code as a basis for relevant safety standards, unless their national stability requirements provide at least an equivalent degree of safety; and

3 INVITES Contracting Governments to the 1974 SOLAS Convention and Parties to the 1988 Load Lines Protocol to note that the above amendments to the 2008 IS Code will take effect on [*date of adoption*] 5 June 2015.

[This relates to a new paragraph \(6.2.3\) in Part B chapter 6.2.](#)

RESOLUTION MSC.415(97)

(adopted on 25 November 2016)

**AMENDMENTS TO PART B OF THE INTERNATIONAL
CODE ON INTACT STABILITY, 2008 (2008 IS CODE)**

THE MARITIME SAFETY COMMITTEE,

RECALLING Article 28(b) of the Convention on the International Maritime Organization concerning the functions of the Committee,

RECALLING ALSO resolution MSC.267(85) by which it adopted the International Code on Intact Stability, 2008 ("2008 IS Code"),

NOTING the provisions regarding the procedure for amendments to part B of the 2008 IS Code, stipulated in regulation II-1/2.27.2 of the International Convention for the Safety of Life at Sea, 1974 ("the SOLAS Convention"), as amended by resolution MSC.269(85), and in paragraph (16).2 of regulation I/3 of the Protocol of 1988 relating to the International Convention on Load Lines, 1966 ("1988 Load Lines Protocol"), as amended by resolution MSC.270(85),

RECOGNIZING the need to include provisions regarding ships engaged in anchor handling, lifting and towing operations, including escort towing, in the 2008 IS Code,

HAVING CONSIDERED, at its ninety-seventh session, the proposed amendments to part B of the 2008 IS Code, prepared by the Sub-Committee on Ship Design and Construction, at its second session,

1 ADOPTS amendments to part B of the 2008 IS Code, the text of which is set out in the annex to the present resolution;

2 RECOMMENDS Governments concerned to use the amendments to part B of the 2008 IS Code as a basis for relevant safety standards, unless their national stability requirements provide at least an equivalent degree of safety;

3 INVITES Contracting Governments to the SOLAS Convention and Parties to the 1988 Load Lines Protocol to note that the above amendments to the 2008 IS Code will take effect on 1 January 2020.

This relates to extensive amendments to Part B regarding anchor handling vessels etc. now inserted above and highlighted where appropriate.