

MARITIME MODULARITY CONCEPT

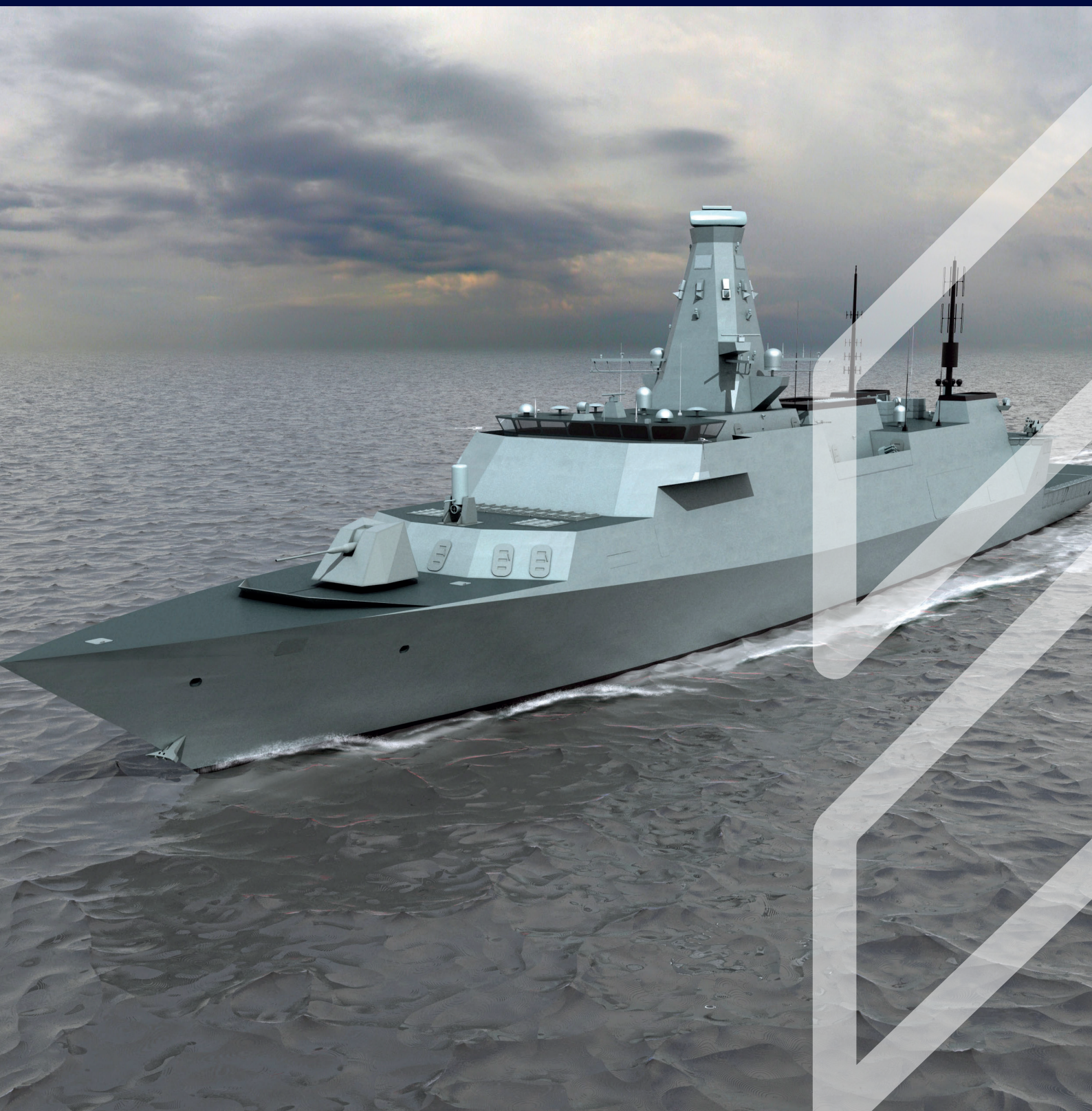



Maritime Operating Concept (MarOpC)

The MarOpC describes how the Maritime Force will deliver National operational advantage, and the changes required to accomplish this aim. It describes the totality of the Maritime Domain contribution to the Integrated Force in achieving the demands of the Integrated Operating Concept (IOpC). At the core, implementing the MarOpC demands that we think and decide differently. The themes, tenets and principles of the MarOpC must pervade our thinking and as such a series of supporting concepts act as a handrail or checklist for capability design, especially in respect to coherency with the MarOpC's three themes (Distributed Protean Force, Wise Pivot, System of Systems).

Contents

Executive Summary 4

Section 1: The Case for Change 6

Context 7

Implications for the Maritime Force 8

Section 2: Maritime Modularity 10

Modularity Development 10

Types of Modularity 12

Benefits of Modularity 15

Risks Adopting Modularity 19

Section 3: Delivering Maritime Modularity... 22

Principles of Modularity 22

Maritime Force Design Principles 22

Force Level Output Considerations 25

Multi-Domain Integration 27

Defence Lines of Development Considerations 28

Executive Summary



Insights/Key Judgements

- The Maritime Modularity Concept provides lessons, considerations and guidance to shape future capability development.
- The speed of technological change and proliferation demands more adaptable, asymmetric, and novel adoption of systems to deter our adversaries.
- Maritime Modularity will enable a more flexible, adaptable, upgradable, and maintainable Maritime Force.
- The benefits include adaptability, time efficiency, possible cost savings, availability, and future proofing of platforms and systems.
- Modular capabilities must be discrete, scalable, available, reusable and integrated.

Why Increase Modularity

Strategic Context. The pervasive theme when describing the strategic environment is 'Change'. Competition for resources, access and influence is escalating and diversifying across the globe. This requires Forward Presence from the Maritime Force and an increasing range of effects. The speed of technological change is increasing, and with it the threat posed by adversaries advancing proliferation and the rate of obsolescence of our own maritime capabilities. This, with the backdrop of an affordability challenge, drives a need to alter the way the Maritime Force approaches capability development. To be cost effective, platforms and systems¹ are designed to operate for decades, and in this rapidly changing environment they will be faced with operational requirements that will change significantly over their service. There is a need for the Maritime Force to balance affordable standardisation, the capacity to rapidly adapt in situ to changing threats, and the facilitation of in-service upgrades and additions.

Operational Context. The return of state competition in the Maritime Domain is intimately linked to technological proliferation, which forces us to change the way we will operate. We need to rethink how we conduct conventional deterrence and look to counter the actions of our adversaries through asymmetric means, tactics and with novel weapons of our own. The Maritime Operating Concept (MarOpC) outlines the operational 'Ways' through which a modular maritime force will function. It will be persistently present, globally; and will exploit the lethality, availability, and survivability opportunities a system of systems approach offers.

*'Capability will be modular rather than platform-specific, and we will be more flexible, adaptable, upgradable and maintainable'*²

¹ Systems will be referred to throughout to cover physical, virtual or organisational attributes.

² MarOpC.

Purpose

The Maritime Modularity Concept emphasises the need for the continued development of an adaptable Maritime Force. It uses lessons in past and current modular development, and design principles from the RN Strategy, to serve as a conscience for capability developers. It provides guidance and considerations to shape future decisions and enable a more focussed and coordinated development of modularity.



Benefits and Risks of Modularity

Maritime Modularity is adaptation, through the timely addition or substitution of specialist or new capabilities at home or deployed; fully integrated to execute specified missions.

Benefits. Modularity offers the Maritime Force multiple benefits:

- **Adaptability.** Deployed forces can rapidly switch task essential equipment or systems; re-rolling without the need to return to a specific location. Following common, and international standards, enables provision and embodiment of capabilities from partner forces.
 - **Time.** Time efficiencies will be realised in ship building/manufacture through the disassociation of capabilities from the platform or system; in modernisation through simplified technology insertion; and operationally through on-task adaptability.
 - **Overall Cost.** Costs of maritime capability could be reduced by the use of modular capabilities across multiple platforms and systems and through the ability to upgrade capability without the need to conduct lengthy refits or upgrades.
 - **Availability.** The reduction in refit/upgrade packages, transit requirements to re-role platforms and the ability to replace systems forward rather than repair, will combine to increase the overall availability of platforms for tasking and persistent presence.
 - **Future Proof.** Where components or capabilities are expected to change multiple times within the lifetime of a platform or system; modularity enables the decoupling of them from platform development, and so can increase the length of service.
 - **People.** Opportunities exist to improve Availability, Sustainability, Lethality and Lived Experience (ASL/LE) across the workforce through adaptable Unit Position Lists and the use of Mission/Combat Teams.
- Risks.** There are equally some risks associated with adopting increasing levels of modularity if not considered early in the capability development process.
- **Integration.** Integration must be considered from the outset to ensure modules, capabilities and people are compatible across the force and to aid any installation/integration requirement. Compatibility, training and system integration all need to be considered to realise the benefits of modularity.
 - **Initial Cost.** Upfront costs for modular capabilities are likely to be higher than built in systems. This must be considered and factored into development but should not deter the investment decisions as through life efficiencies are expected.
 - **In Service Cost.** Supporting and transporting equipment and teams associated with installed modularity and mission/combat team modularity will incur cost and logistical challenges. It is likely that uninstalled modules will require 'keep alive' facilities which would incur additional infrastructure and resource requirements.
 - **Ship Building.** A risk to be considered in the ship building area is the platform structural integrity and balance effects of large mission bays, or easily accessible modules. Developments in modular capable platforms have highlighted key lessons that must be incorporated to ensure that platform performance is not affected adversely.
 - **People.** An increasingly modular force does not necessarily result in workforce efficiencies. Crewing models in some modular capable platforms have resulted in an inability to conduct certain maintenance tasks to remain at sea. Future workforce implications of modular capabilities must be considered at the earliest stages of development to avoid this risk.
 - **Cyber security.** The procurement of hosting platforms, applications, integrators and the variation in system configuration associated with modularity presents a challenge from an accreditation and cyber security perspective that must be considered.

Section 1 – The Case for Change



Insights/Key Judgements

- Global strategic, and technological, change demands a balanced Maritime Force with the capacity to rapidly adapt.
- National ambition, as articulated in Defence Policy, requires the force to sustain advantage through S&T and build resilience, both at home and overseas.
- A persistently globally deployed force can only be realised through coherent modularity where single platforms are no longer the capability focus.
- The Maritime Force will have to evolve faster than it has ever done before and continue doing so into the future.
- Modularity will make the Maritime Force Adaptable, Affordable and Technologically Resilient. It should be adopted as a Design Principle; enabled by complex systems integration.

Modularity is not a new concept. In the maritime domain, from the development of modular ship-building during the Second World War to the US Navy’s operationally adaptable Littoral Combat Ship, it has had many definitions and applications. This Maritime Modularity Concept is a functional sub-concept of the Maritime domain keystone Maritime Operating Concept (MarOpC).

Royal Navy Strategy is clear in its articulation of “A world class, global Navy, with inspired and inspiring people, working as one team to be lethal, efficient, and innovative, to play our part for the people of the United Kingdom, protecting them, preventing conflict and ready to fight our enemies whenever and wherever needed.”³ To realise this, and answer the demand set by ISDR 21⁴, DCP 21⁵ and IOpC⁶, the MarOpC describes a “Wise Pivot of the Maritime Force from a platform-based, role-specific, and aggregated Fleet, to a distributed protean force, operating as a system of systems”⁷. The Maritime Force will need to be asymmetric in its methodology. The modular approach will be its defining feature to enable appropriate mass and increased adaptability whilst maintaining pace with technological change to continually enhance lethality.

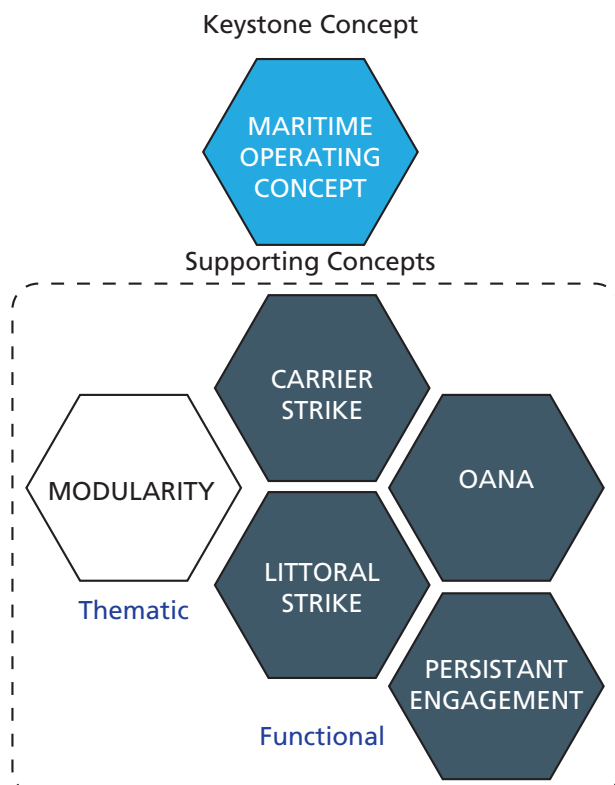

Strategic Context

Global Change. The Strategic environment, and its predominant trends, is well articulated across the overarching concepts this document supports. In relation to Maritime Modularity the pervasive theme is 'Change'. Global competition for resources, access and influence continues to escalate, diversify, and can emerge in unexpected places. The range of effects and breadth of presence required of the Maritime Force will continue to increase. The impact of climate change will be a substantial challenge which will influence the design and attributes of all future systems and capabilities for the Maritime Force. This will also add to the changing demographics that will disrupt social models and challenge resource and wealth distribution, all of which could manifest as security challenges. Technology proliferation is both a physical and capability development threat and is one of the key drivers for Modularity. Accelerating availability of high-tech capabilities makes an attack feasible from a broader range of actors in an increasing number of areas. Innovation and technological advances are happening faster than ever before making it more difficult for Defence to remain on the leading edge.

Technological Change. The speed of technological change increases the obsolescence rate of traditionally designed maritime capabilities. This, coupled with the fundamental affordability challenge, drives a need to alter the way the Maritime Force approaches capability development. To be cost effective platforms are designed to operate for decades, and in this rapidly changing environment they will be faced with operational requirements that will change significantly over their service. The same is true for our digital infrastructure which is often designed with little scope for future development necessitating the need for a major change programme to make small improvements. There is a need for the Maritime Force to balance affordable standardisation, the capacity to rapidly adapt to different missions and changing threats, and the facilitation of in-service upgrades.

National Ambition

ISDR 21 evaluates the global trends facing the UK and sets the strategic vision. DCP 21 extracts what this means for Defence, articulating its contribution to the overarching objectives of ISDR 21, each of which has a bearing on, and can be influenced by, an increasingly adaptable and modular Maritime Force. The key points are highlighted below.

- **Sustaining strategic advantage through science and technology.** Maritime technology accelerators and centres of innovation will complement the Defence Science and Technology Strategy and the Defence and Security Industrial Strategy. This is a symbiotic relationship that will help keep the maritime force on the leading edge of technological advances.
- **Shaping the open international order of the future.** Supporting the Defence contribution will require persistent global presence. This will require the maritime force to be more available more of the time, and able to rapidly adapt to varying missions and tasks.
- **Strengthening security and defence at home and overseas.** The centrality of alliances to strengthen global security will require the maritime force to be ever more interoperable and interchangeable. A more adaptable force able to pivot from deterrence, through security and counter terrorism operations, to peacekeeping; will provide greater utility and choice to decision makers.
- **Building resilience at home and overseas.** The ability to support resilience at home and humanitarian assistance overseas is greatly increased through a more adaptable and available maritime force.

3 RN Strategy (draft).

4 The Integrated Review of Security, Defence, Development and Foreign Policy.

5 Defence Command Plan 21.

6 Integrated Operating Concept.

7 Maritime Operating Concept p3.

Operational Context

Maritime Landscape. There is a changing balance of conventional Naval power. The scale of investment challenges established security norms, with growth expected to continue apace. The competition for operational advantage in the North Atlantic increases with our critical national infrastructure under threat after generational leaps in terms of maritime lethality, with aggressive posturing to match. This return of state competition in the maritime domain is intimately linked to technology proliferation which forces us to change the way we think about conventional deterrence. Where previously we have maintained deterrence by punishment, we can no longer depend on technological superiority and will rely on conducting deterrence by denial through a greater focus on the protect, engage, and constrain framework of IOpC. We must counter the actions of adversaries using asymmetric means and tactics and novel weapons of our own, as part of the integrated Multi Domain approach.

Maritime Operating Concept. The UK's Maritime Force is a globally deployable, world class force that must continue to be capable of responding with the right capabilities at the right time. The MarOpC outlines the operational 'Ways' through which a modular maritime force will function.

*'Capability will be modular rather than platform-specific, and we will be more flexible, adaptable, upgradable and maintainable... We will cease vesting capability in singleton platforms, where utility and function are fixed. Instead, we will distribute capability in interchangeable modules ... This increased distribution possible through modular systems enables rapid reconfiguration, increases operational effect and presents our adversaries with more dilemmas.'*⁸



Implications for the Maritime Force

Shifts in the strategic environment, the technological landscape and the maritime domain are moving towards almost real time changes that the Maritime Force must be capable of adapting to; evolving faster than it has ever done before and continuing to do so into the future.

Adaptability. Whilst modularity has gradually become more operational, warships are still broadly designed to be highly specialised or highly generic. The highly specialised warships have critical roles within the maritime force, and are world leading in their capabilities, but can be inefficient or have limited effect when conducting a task for which they have not been designed. General Purpose warships have broad utility but can be limited in capacity and cannot quickly adapt to every eventuality; but rather make the best of each situation with their generic capabilities. Both types of vessels are 'Flexible', rather than 'Adaptable'.

Flexible – A platform designed for a specific purpose, but ready to perform various roles required of it, to an acceptable level.

Adaptable – A platform designed to accommodate multiple specialist capabilities and so able to perform specific roles after a rapid change, or addition, of a modular system.⁹

The same is true of our digital architecture which must remain at the forefront of technology. The ability to rapidly update, upgrade or repair digital systems is enhanced if modularity is introduced with smaller more frequent updates used to keep systems fresh, enable quick responses to threats and changes to operational needs and limit the risk of breaking something critical during a major system change.

The global nature of the UK's Maritime Force, and the rapidly changing variety of threats it could face, requires operational modularity in order to make our capabilities adaptable as well as flexible. This moves the Maritime Force from the more traditional 'just in case' mindset to an adaptable 'just in time' mindset.¹⁰

⁸ Maritime Operating Concept p26.

⁹ The Royal Institute of Naval Architects – The Human Element of Modular Capability, c. Kelly et al. 28 Sep 2016.

¹⁰ The Royal Institute of Naval Architects – The Human Element of Modular Capability, c. Kelly et al. 28 Sep 2016.

Affordability. Highly specialised world class platforms and systems can be costly to develop and build, and a highly capable platform centric approach to the Maritime Force is becoming increasingly unaffordable. This cost makes the extension of the service life of current and future warships by adapting them to cope with new challenges, adversaries, and technologies financially appealing. Modularity across the Maritime Force can reduce both the time and cost of modernisation to adapt to new missions and allow the incorporation of new technology.

Technological Resilience. It is difficult to predict what missions the Maritime Force will have to be capable of conducting through the lengthy life span of a capability. The increasing pace of technological change will drive a more frequent modernisation programme into ships and systems as platforms will outlast the integrated capabilities by a significant degree. Modernisation is expensive when conducted through a major change programme, and often the physical limitations of the platform can constrain what can be achieved. Although relatively costly, sometimes the only cost-effective decision under the current model is to retire rather than modernise a platform. Adopting operational modularity offers technological resilience by disassociating the capability from the platform and simplifying the upgrade process; thereby maximising every opportunity to insert new and innovative capability.

A Design Principle. *Taken in combination, a Maritime Task Group may be potent across all sub-domains, but it was not designed with interdependency, modularity, distribution or to be protean in mind from the outset.*¹¹ Technological developments now make achievable the operational modularity previous programmes have not been designed to, or able to, attain. Future ship building projects and the development of autonomous systems enables the maritime force to be designed with modularity built in from the start. This principle, when applied to capability insertions into current platforms, will also enable the maritime force to make best use of the 'now' force within the future concept as the 'new' force is introduced.

System of Systems Approach (SOSA). The MarOpc advocates a move towards adopting a System of Systems approach to break the link between platforms and effects. This approach can increase lethality through proliferation of sensors and effectors; improve availability and resilience by removing single points of vulnerability; and increase availability, resilience and persistence by increasing available choices. A System of Systems approach increases the scope for capability and technology insertion, increasing agility and ultimately contributing to operational advantage. Modularity is a key component of SOSA and contributes to the benefits by allowing sensor, decider, effector elements to be discrete and dispersed but integrated.

Complex Systems Integration. The integration requirements of Maritime Modularity are significant, and this is critical to success. This applies not only to future capability development, but is key to maximising the value, operationally and financially, across the 'old', 'now' and 'new'¹² force to meet the real time changes we are experiencing. The development of modularity up to now can teach us much about how to achieve this successfully, but also highlight the risks of advancing too far before the complex integration questions have been resolved.



11 Maritime Operating Concept p13.

12 Maritime Operating Concept.

Section 2 – Maritime Modularity



Insights/Key Judgements

- Modularity can be employed across the Maritime Force from ship building, through integrated or installed modularity, to digital architecture and mission/combat teams.
- It will realise benefits in mission adaptability and international interchangeability.
- It will save time in capability development, force modernisation and operationally, which will also increase platform availability.
- Modularity integration, up front costs, ship building implications and workforce impacts must all be considered at the outset of all modular capability development.

Maritime Modularity is adaptation through the timely addition or substitution of specialist or new capabilities at home or deployed; fully integrated to execute specified missions.

Maritime Modularity Development

Modularity is not a new concept in the maritime domain. Block construction practices date back as far as the mid twentieth century and the adaptability of platform design has slowly progressed closer towards operational adaptability in the last fifty years.

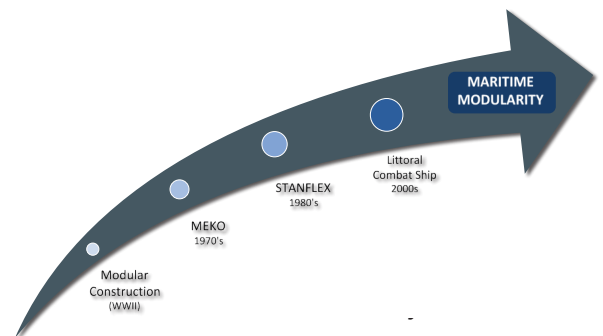

In the 1970s the MEKO¹⁵ class of vessel took block construction practices a stage further than had previous been considered. The Danish Navy progressed this idea with the STANFLEX (Standard Flex) design in the 1980s. The US Navy's Littoral Combat Ship (LCS) sought to fully operationalise the idea of modularity.

Definition of Maritime Modularity

The development of modularity described lends itself to multiple definitions, however some aspects are all pervasive. Describing modularity in terms of interchangeability, systems and integration are common to most. RAND have defined it as '*... partitioning a system into modules that consist of self-contained elements*'¹³ ; and NATO as '*...a prepared package of equipment designed to be self-contained with suitable ship-to-module interfaces (space, power, communication links etc) that could be quickly installed in a host ship [and] could provide an alternative means of enhancing the organic capability of naval vessels for other types of missions.*'¹⁴

The Royal Navy have used aspects of modularity for some time which should be reflected in defining what Modularity means in terms of this concept. It describes an operational modularity that provides the adaptability to meet the Maritime Forces' challenges wherever and whenever needed, whilst remaining at the leading edge of technological advances.

13 Designing Adaptable Ships – RAND Study.

14 NATO Industrial Advisory Group Mission Modularity Studies – 15th International Naval Engineering Conference and Exhibition 2020.

15 Merhzwecks Kombination or Multi-Role Combination.

Saving Time and Money

MEKO (Merzwecks Kombination or Multi Role Combination)

In the 1970s Blohm and Voss designed a common hull warship that had specific locations designated for operational modules, primarily weapon systems. The MEKO modules were interchangeable due to their standard footprint and deck penetration but were not designed to be removed and replaced outside of a significant refit period. They were bolted into place and sealed with resin to create systems that were structurally integral to the ship.

Over 60 warships were built for 11 Navies, with reduced construction costs and build time reportedly enabled through the parallel development of cheap and simple designs of both vessels and modules. This is an example of modularity that offers benefits in reduction of cost and ship building time, but with limitations in the operational adaptability and platform availability due to the requirement for refits to re role the platform.



STANFLEX (Standard Flex)

The STANFLEX system was a standard vessel with standard propulsion and standard bays for containerised equipment; programmed for 16 modular vessels to replace 22 legacy platforms. As with MEKO these dropped into deck apertures, and whilst designed for home port role change could be installed and tested within hours and without a significant refit – a step further than the MEKO.

This system offers benefits in reduced cost and ship building timelines. The initial class of ship was replaced in the 2000s by the Absalon Class and no new modules were needed for the new warships. Importantly it has proven adaptability, to a point, and improved platform availability; it demonstrates that modules can relatively swiftly be replaced. Lessons continue to be learnt; for example, this system identified issues in crew training following a module change.



Types of Modularity

Maritime Modularity is adaptation, through the timely addition or substitution of specialist or new capabilities at home or deployed; fully integrated to execute specified missions.

Building on the definition given for Maritime Modularity, this section proposes five types of modularity to structure the coherence of capability development.

Build Modularity. This type of modularity covers the generic parts of a platform that can be built into any class of ship or submarine. Referred to as Common Modules¹⁶ in RANDs Designing Adaptable Ships, this includes, amongst other things, some structural sections, hotel services, workspaces, etc. Producing these as modules can aid ship building through larger production runs, but they cannot be easily removed or upgraded once installed.

Integral Modularity. These capabilities have defined boundaries both in application and installation and were used in the MEKO and STANFLEX systems. They rely on locations within a platform designed to accommodate specific systems that can be removed and replaced or upgraded but require a refit period to do so. They form part of the ship structure and integrity so do not adversely affect stability or structural support. Potentially future application here includes power generation and electrical distribution to aid future proofing.

Installed Modularity. This type of modularity describes the payload insertion method used by the Littoral Combat Ship and envisaged in the Royal Navy PODS¹⁷ programme. These capabilities use defined interfaces and connections replicated across multiple ship classes to enable operational adaptability. Whilst often visualised in ISO type containers, this is not necessarily how the capability will be developed. They have the ability to be offset within a system of systems; deployed and employed across multiple domains.

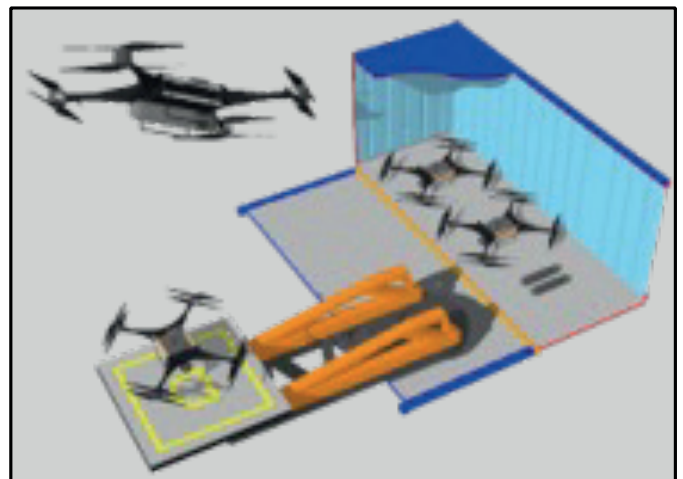
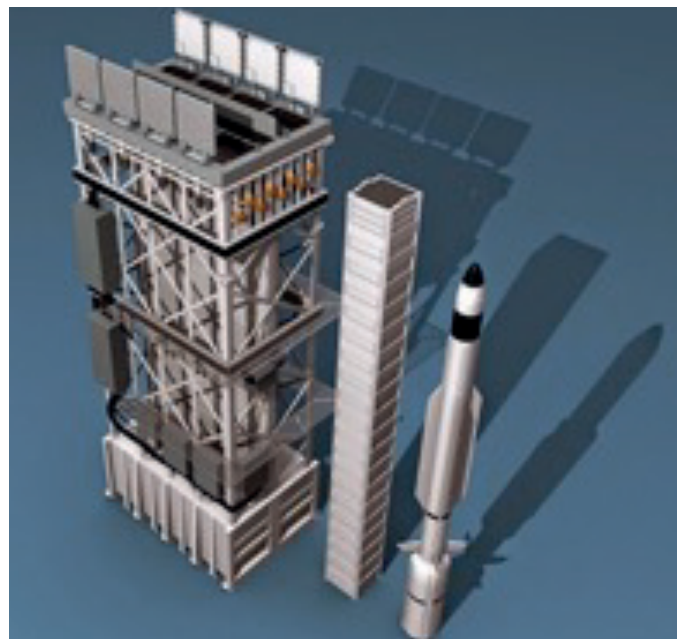

¹⁶ Designing Adaptable Ships – RAND Study.

¹⁷ Persistent Operational Deployment System.

Israeli Navy 'Reshef' Design

The 'Reshef' design has modularity at its core with modular launchers designed for commonality and a multi purpose deck. Designs show additional launchers, containerised capabilities, autonomous systems and conventional aviation as potential users of the aft deck. This combines the principles of installed modularity, integral modularity and mission teams. This extends to a mission oriented Combat Information Centre (CIC) with open architecture combat systems suit to enable fast & simple COTS\ MOTS systems integration. This sees a move from systems based architecture to an application basis that allows variable warfare scenarios over a common server.

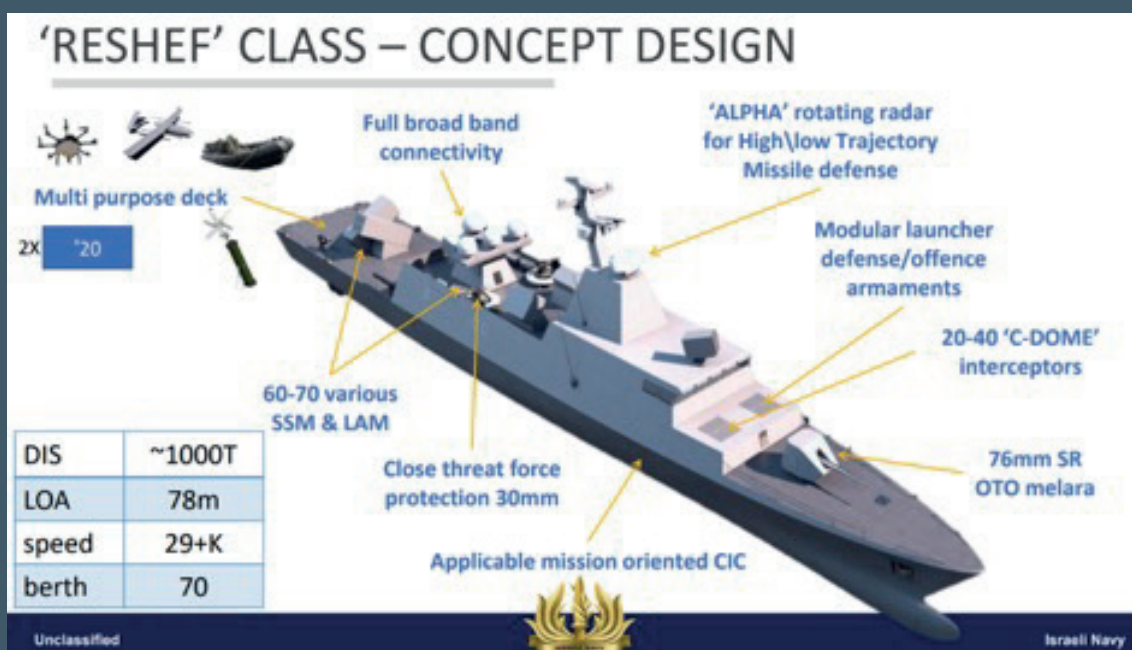



Mission/Combat Team Modularity. The aspect of modularity that is already used to great effect in the Maritime Force is the task grouping of capabilities and personnel to provide specialist capability to platforms. This has included Fleet Air Arm Flights, Commando Boat Groups, Phalanx Teams and Ships' Force Protection Teams amongst others. These capabilities require the same integration considerations as any type of modularity.

Digital Modularity. Modularity is not just a platform phenomenon. With multi-domain integration paramount, the digital architecture that underpins and enables all capabilities will become critical to enabling the distributed, protean Maritime force. To achieve this, all digital systems must be modular by design and built using a microservices architecture, that digitally mirrors our system of systems approach to force design, in which an application is composed of many discrete microservices and capability is built from network connected nodes. The ability to integrate new or mission specific applications to any combat system architecture should become the default position. This should be as simple as adding a new app to your smart phone. The success of Installed and Mission/Combat Team Modularity is reliant on the ability to seamlessly integrate people, equipment and digital systems within the overall digital architecture. This includes networking users and systems without impediment.

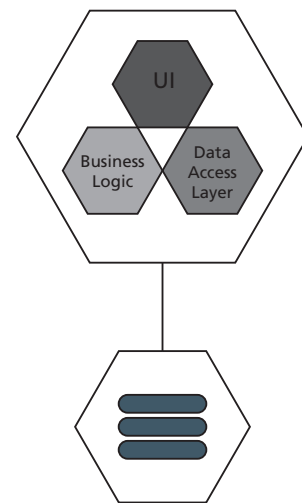

Monolithic Architecture

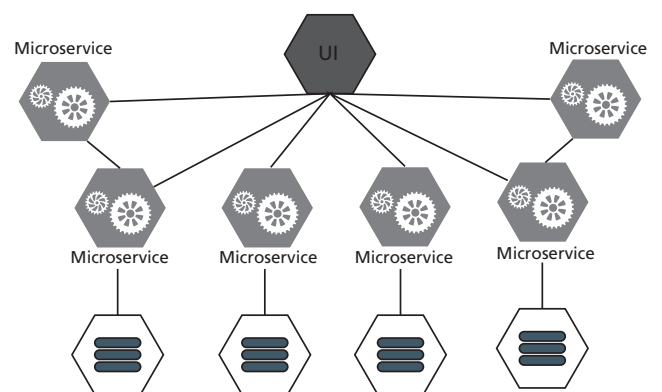

Microservice Architecture

Benefits of Maritime Modularity

The benefits of modularity are numerous and can be found across multiple papers and publications. They can be broken down into five themes and are explained below.

Adaptability. Platform adaptability can be seen through the length of the development process of platforms. The operational benefit of adaptability is a function of integration time and complexity.

Whether relatively easy to integrate, or hugely complex, the quicker it can be done has a direct impact on its operational utility to the Maritime Force. Modularity offers two huge benefits to Operational Adaptability.

- **Mission Adaptability.** Platforms that can rapidly switch mission packages whilst deployed are far more adaptable. By forward deploying task essential equipment and modules, platforms can be re-rolled without the need to return to home port rapidly increasing reassignment timelines.
- **International Interchangeability.** By following NATO common standards modularity can be used across partner's platforms to increase force integration, and in support of alliance missions when the UK have no platforms available. Similarly, our allies' capabilities can be integrated into UK platforms when deployed to increase adaptability (provided these common standards are used).

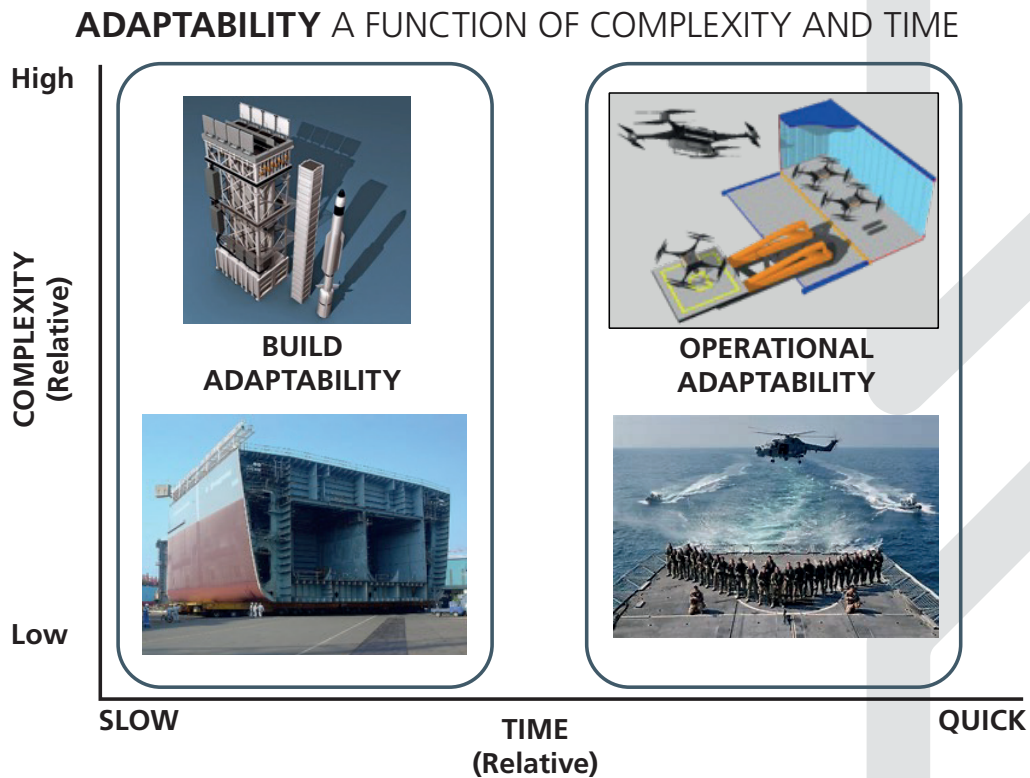



Missiles for all Missions

MK41 Vertical Launch System

MK 41 VLS is a launching system that can simultaneously communicate with weapon control systems and missiles of every warfighting mission area: anti-aircraft, anti-surface, anti-submarine, ballistic missile defence and land attack. The system is designed to accept any missile into any cell.

The basic building block of the system is an eight-cell MK 41 VLS module that can be assembled in desired numbers to meet specific mission and hull requirements.

In this case, the VLS module is Integral Modularity whereas the ability to adapt for multiple weapon types is Installed Modularity.

Operational Advantage. The employment of mission based modular capabilities offers the Operational Commander greater choice in how to disperse and distribute their force. This may provide tactical advantage through greater coverage and increase resilience through dispersal of valuable assets. Dispersal of modular capabilities also affords the opportunity to employ deception techniques when using commonly packaged/branded modules containing varying or even dummy loads.

Time. There are three areas where the Maritime Force can realise time benefits from a more modular approach.

- **Manufacture.** By disassociating modular capabilities from the platform further concurrency is achievable in the build process. This allows for quicker development of both platforms and the system capabilities.
- **Force Modernisation.** With new modules and capabilities developed independently from the host platform, and able to be introduced outside of major upgrade packages, the time required for the process of modernising the Maritime Force through technology insertion can be significantly reduced.
- **Operational.** Platforms that can rapidly switch mission packages whilst deployed will remove the requirement to sail platforms across the globe to meet those tasks. The ability to replace modules will also reduce down time due to malfunctioning equipment.

Cost. There are two key areas where it is assumed cost savings can be realised.

- **Manufacture.** The time saved by concurrently developing and building platforms and modules could also translate into cost savings. The ability to use the modules across multiple platforms, and future programmes, could reduce overall design and construction costs. This will also reduce the quantity of high-cost sensors, effectors, deciders, and enablers required. Platform size can be reduced where there is no longer the need to design hulls capable of all missions without adaption and can be built 'fitted for' specialist missions rather 'fitted with' – the 'in time' Maritime Force verses the 'in case'.

- **Force Modernisation.** Time saved during technology upgrades and insertions at through life upgrades will make this process easier and cheaper.

Platform Availability. Platform availability will increase through four benefits of modularity.

- **Force Modernisation.** Reduced time for technology upgrades will allow for greater availability across the Maritime Force.
- **Mission Adaptability.** The forward deployed modules and task essential equipment that increases the adaptability of the force will also result in increased availability for platforms on task.
- **Synthetic Training.** Modularity that can be accessed whilst removed from the platform will allow for remote training to be conducted shoreside allowing platforms to remain deployed. This applies for individual and collective training that will assist the forward deployment of platforms with the availability benefits here already proven.
- **Capability Maintenance.** The ability to replace aspects of capability swiftly, allowing maintenance to occur shoreside reduces platform unavailability due to malfunctioning equipment.

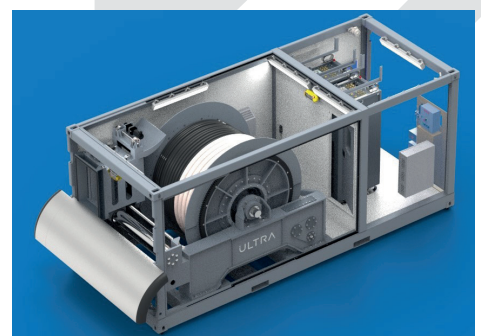

Future Proofing

Increasing modularity calls for steps to be taken to future proof the Maritime Force to allow for technological advances and the addition of improving capabilities over a platform's lifetime.

A 2016 RAND paper, 'Designing Adaptable Ships – Modularity and Flexibility in Future Ship Designs', four major technological trends are identified that are likely to influence naval operations:

- Rapidly increasing use and effectiveness of off board uncrewed systems.
- Growing importance of use of the electromagnetic spectrum as a weapon.
- Enhanced capabilities for long range targeting.
- Increasingly networked nature of the battlespace.

All involve rapid change and inherently unforeseeable technological developments and will require future vessels to be designed with more capacity or capability than immediately needed to ensure they are able to accommodate these trends. The paper outlined five areas where future vessels will need to be designed with built in redundancy to allow for the rapid technological advances forecast.

People. The Future Crewing Concept (FCC) considered by the NEC¹⁸ described the case for increased use of innovative crewing solutions. This concept seeks to increase workforce resilience and lethality through the use of adapted Unit Position Lists, Combat Teams and selected dual crewing of platforms. The core principles include the use of a smaller core crew supplemented by Combat Teams focussed on mission requirements. The benefits include greater lethality due to the tailored application of specialist personnel and the ability to invest in warfare training and development shoreside when not on operations. Initial Proof of Concept (IPoC) work under the FCC has found that dual crewing can improve Availability, Sustainability, Lethality and Lived Experience (ASL/LE).

Risks of Adopting Greater Modularity

There are equally risks associated with adopting modularity as a design principle that must be considered during the development of platforms and modular capabilities. These fall into four categories.

Clarity of Requirement. A modular solution should add demonstrable value to a capability solution and therefore should only be adopted when the evidence supports this. This concept demonstrates the breadth of applications where modularity can be employed and the benefits that could be realised, but it does not advocate modularity for the sake of it. Identifying these potential benefits at a capabilities inception and testing them against a non-modular solution is critical and will prevent unnecessary exploitation of this idea where traditional methods will suffice.

Integration. Modularity needs to be considered at the inception of capability development and taken as a key design principle to ensure the installation and integration arrangements are fully considered. This integration includes mounting, services, processes for weapon and sensor alignments, digital compatibility, crew integration and collective training requirements. Gaps or oversights in any of these areas risk rendering modularity a burden rather than realising the benefits already mentioned.

Cost. Initial modular design and construction costs may increase relative to the in-built systems they replace. This increase is likely to be mitigated in the through life cost savings that can be realised. Some research, including RAND¹⁹ and RINA²⁰, also suggests that platforms potentially need to increase in size to accept modular installation and thus could become more expensive to build. Finally, ill-defined standards and interfaces designed into platforms and modules will increase integration costs.

Ship Building. Increasing the length of time a platform is in service, due to the benefits modularity provides in the modernisation process, has the potential to create gaps in the National Shipbuilding pipeline with knock on implications to UK prosperity and associated skills wastage in the workforce. A further risk to be considered in the ship building area is the platform structural integrity and balance effects of large mission bays, or easily accessible modules. Developments in the Littoral Combat Ship have highlighted key lessons that must be incorporated into the development of the Maritime Force to ensure that platform performance is optimised whatever the module load is embarked.

People. There is an inclination to look at an increasingly modular force as a means of achieving workforce efficiencies, by way of creating smaller 'core' groups that are supplemented by Mission/ Combat Teams as and when the task requires it. This may however reduce overall resilience and exacerbate the impact of soft gapping with less people to achieve basic tasks. Evidence exists of these issues with the USNs Littoral Combat Ship where the original crewing models left the platform unable to conduct certain maintenance tasks to remain at sea (see following Modularity Lessons Vignette). Future workforce implications of modular capabilities must be considered at the earliest stages of development to avoid this risk. In addition, persistent deployment of platforms as they swap mission sets and demand for mission/combat teams may increase deployment churn and duration for the workforce.

18 20220428-NEC_FCC_Note_Final-OS.

19 Designing Adaptable Ships – RAND Study.

20 The Royal Institute of Naval Architects – The Human Element of Modular Capability, c. Kelly et al. 28 Sep 2016.



Learning Modularity Lessons

The Littoral Combat Ship s (LCS) initial requirements called for twenty mission module stations emphasising rapid reconfiguration. These included onboard and off board systems and various maintenance & support capabilities. This was a blend of MEKO and STANFLEX systems but introduced the inherent commonality and adaptability of ISO standardisation. The designed adaptability included the use of three mission module types: surface warfare, MCM and anti submarine warfare, at its core from the start and that the platform would be able to re role in several locations globally.

However, the LCS did not develop in the way originally intended. They were faced with issues in separating the programmes for the ships and the modules, not least that the US Congress continued to fund the ships whilst making efficiencies in the funding of the mission modules. Modular capabilities were also slow to achieve acceptance and testing. The LCS has been plagued by criticism of complexity, lack of firepower and engine breakdowns causing cost over runs. In addition, lower basic crew numbers caused maintenance tasks, husbandry and management overheads to exceed workforce capacity.

For LCS there was space for some flexibility in the design but insufficient consideration as to the amenities that these mission modules would require to operate, especially if they were trying to use more than one module at any one time. The programme has now moved away from adaptability through containerised mission modules as it is currently only possible to re role in a home port; and it isn't as swift as originally designed. Containers are now a fixed part of the ship, and the class has separated into the three specialised capabilities.

Adaptability requires more space overall and needs adequate services and margins in the ships systems and networks to support a wider range of modularised capabilities. The LCS issues appear to be in the platform design and construction process rather than the concept of modularity itself. The detailed lesson identified studies that have been conducted into the LCS should guide future platform design. These include: the necessity to develop modular capabilities at the same rate as the host platform, careful consideration of workforce numbers and simplicity in the interchangeability of capabilities to prevent 'fleets within fleets'.

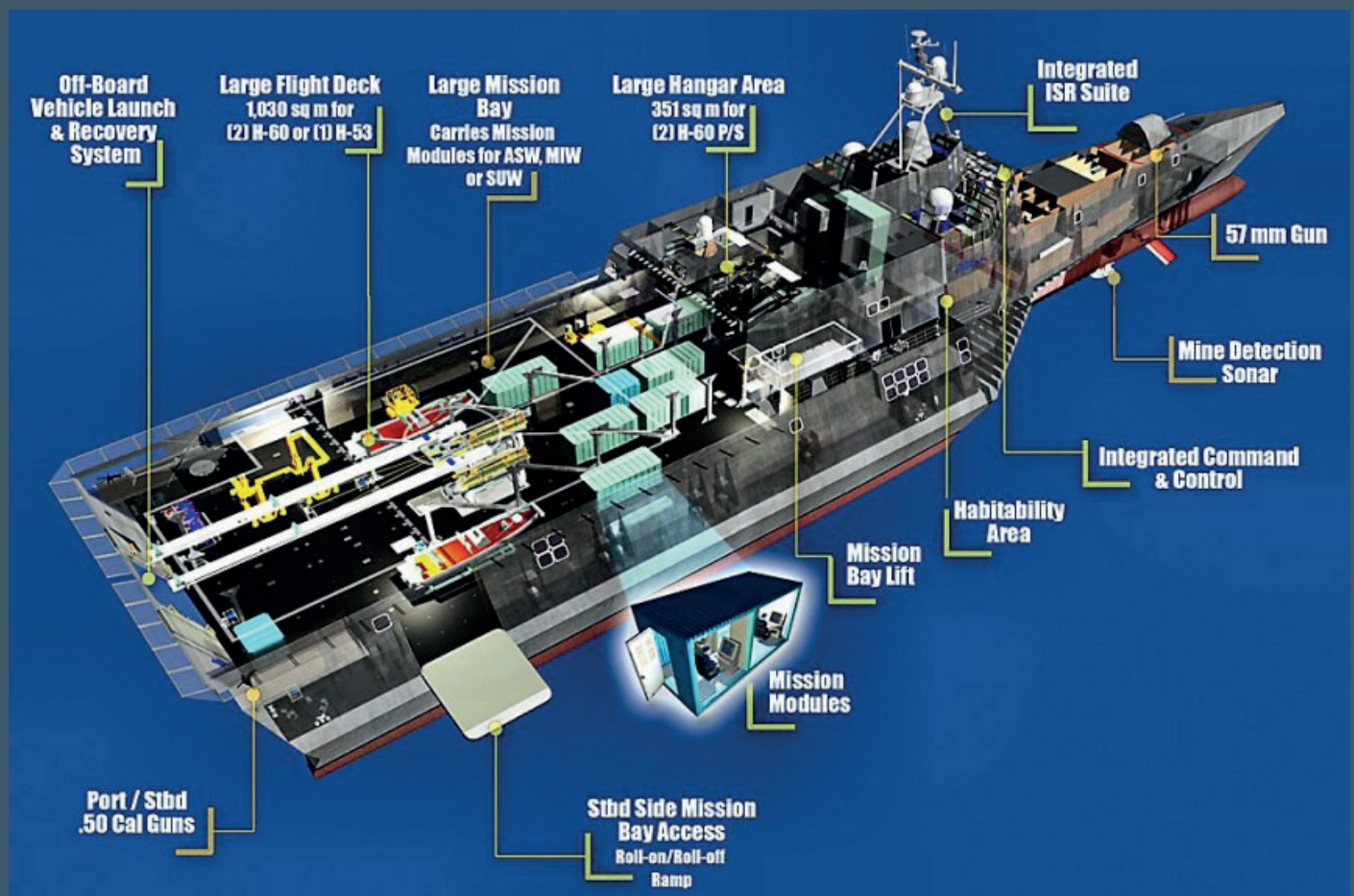

Section 3 – Delivering Maritime Modularity

Insights/Key Judgements

- Modular capabilities should be discrete, scalable, available, reusable and fully integrated.
- Modularity will support all of the Maritime Operating Concept's design principles to create a more lethal, available and sustainable force.
- There are opportunities across all the Maritime Force Level Outputs to increase integration, utility, warfighting capability and technological resilience.
- A modular Maritime Force is intrinsically multi domain.
- Pan DLOD integration of modular capability is critical for operational effectiveness. Modular capability will also prove a benefit across the Maritime Force DLODs.

- **Reusable.** True operational adaptability can only be achieved with sufficiently robust and reusable modular capability. Fixing capabilities, even if designed to be modular, to platforms instantly removes any adaptability built into the Maritime Force.
- **Integrated.** Effective modularity is dependent on the System of Systems, and vice versa. Capabilities must be linked through common interfaces and standards. Module to platform integration and crew to module integration is critical for operational effectiveness. Integration applies to the structural integrity and stability of the host platform as much as it does to digital commonality. This is as pertinent to the introduction of a helicopter to the flight deck, as it is for a POD in a mission bay and should be designed in to avoid future costs and risks.

Design Principles for the Maritime Force²¹

The Design Principles described in the MarOpC articulate how the Maritime Force will be more lethal, more available, and more sustainable. They set the conditions to accelerate to the future and ensure that we will implement the direction from the Integrated Review. Maritime Modularity will support these principles.

- **Focusing on offensive warfighting capability able to deter hostile states.** Modular capabilities will be compatible with the maritime force to offer the adaptability to deploy and employ multiple types of systems.
- **Being globally present and persistently engaged.** Capability needs to be adaptable at range and tailored to meet the demands of the imminent task.

General Principles of Modularity

Whilst they will not be applicable as a rule across every type of Modularity, several guiding principles can be followed to steer capability development and realise the benefits of modularity.

- **Discrete.** Modular capability should be self-contained; able to be integrated for use across the Maritime Force. Whilst linked as part of a system of systems, they should be distinct capabilities to avoid inefficient duplication.
- **Scalable.** Modular capability should be able to not only integrate into single unit level operations and have the capacity to scale up to Maritime Task Group or Joint Task Force level.
- **Available.** The quantity and readiness levels of the modular capability should be modelled to ensure task and operational concurrency assumptions can be maintained. Platform availability benefits can only be realised if sufficient modular capability is developed.

²¹ Maritime Operating Concept p23.



- **Being at the heart of the Integrated Force and being interchangeable by design with our closest Allies.** An increasingly modular maritime force will amplify effects across domains and government organisations achieving national operational advantage; through the ability to enable or be enabled by capabilities from all areas.
- **Prioritising autonomy and the synthetic environment in everything we do.** Autonomous systems contained within installed modularity can be moved around the maritime force, or indeed deployed ashore. The benefits the synthetic environment in training, decision support and digital integration can be adapted to any platform or environment.
- **Adopting a modular approach to introducing new capabilities.** A move away from capabilities vested in single platforms towards the system of systems approach will create a more flexible, adaptable, upgradable, and maintainable maritime force. The 'plug and play' method of capability introduction, enabled by the common digital architecture will increase operational effect quicker, and present adversaries with more dilemmas, more often.
- **Investing in data exploitation systems that drive rapid and accurate decision making.** The open architecture that digital modularity will enable will maintain the digital backbone capability to allow the capacity to process and exploit data for better decision-making.
- **Being a diverse and inclusive workforce.** Mission/Combat Team Modularity will allow the Maritime Force to focus expertise where it is most needed and bring diversity to deployed capabilities.
- **Adopting a modernised support enterprise optimised to deliver availability.** Persistence will mean adapting forward, maintaining at reach and leveraging interchangeability with allies.

- **Incorporating environmental sustainability into our core business.** As the MarOpC states, *'In concert with a modular approach, we will update our capabilities incrementally, ensuring that we avoid carrying a legacy of high-carbon technologies beyond the point where viable alternatives exist.'*²²
- **Ensuring that all capability delivered into service is fit for purpose at the time of delivery.** Modularity allows for quicker technological insertions without the need to build new platforms.

22 Maritime Operating Concept p34



Modularity in Uncrewed Systems

Modularity offers the ability to exploit rapid technological advances through the addition of uncrewed/autonomous systems to existing platforms. However, these systems can also exploit modular principles to further enhance the range of capabilities available. Modular payloads within uncrewed systems allow common host platforms to be embedded within a task group/theatre whilst still retaining choice in the capabilities available.



Force Level Output Considerations²³

The Maritime Force, as described in the MarOpC, is organised around four, mutually supporting force level outputs: Homeland and Operational Advantage in the North Atlantic; Persistent Engagement; Carrier Strike; Littoral Strike. Modularity will play a role in achieving these outputs. Some of the maritime force characteristics are common to all four: integrated by design; Contingency in use; The best technology; The leading European Navy in NATO; A warfighting contribution orientated around NATO. Each of these characteristics create opportunities for modularity to be applied:

- Adaptable platforms to suit the mission across Protect-Engage-Constrain-Warfight.
- Provide a global and persistent footprint through dispersal of capabilities and enhanced ability to forward deploy units.
- Speed up decision making and enhanced integrated action through a Maritime Force at very high readiness that is designed to adapt to the mission.
- Opportunity to share modular capabilities with partner nations improving our contribution to NATO.
- Opportunity to work across TLB's to deliver capabilities that enhance Multi-domain Integration (MDI).
- Development of autonomous, semi-autonomous or uncrewed systems that can operate from a range of locations.

'Maritime Special Operations (MarSpO)'

There is a move to improve integration and novel capability development focussed on increasing Special Operations in sub-threshold competition with our adversaries. MarSpO sees 'Every Ship a Station', contributing to all Force Level Outputs. A modular approach enables MarSpO activity through integrating people and capabilities, improving the ability to disperse forces across a range of platforms and adaptability to suit operational needs.



Homeland, CASD & OANA

An integrated Royal Navy, at the heart of NATO; delivering CASD, protecting our homeland and our allies.



Littoral Strike

A persistently engaged & technologically enabled Commando Force capable of Strike and Special Operations



Carrier Strike

The heart of the Royal Navy's – and NATO's – warfighting capability. Built around QEC to deliver mass through autonomy



Persistent Engagement

A high utility force optimised to deliver persistent global presence

²³ Maritime Operating Concept p37.

Royal Navy PODS (Persistent Operational Deployment System)

PODS are interchangeable modules that can be fitted to the future surface fleet. They are similar to the design of a conventional shipping container; the aim of the pods is to create and utilise the idea of a 'plug and play' warship and will enable Royal Navy ships of all sizes to be much more adaptable and versatile when on deployment.

Initially, PODS will be limited to mission modularity (A non core capability/platform), integration of capabilities into a container, on and off board movement systems and storage. PODS will primarily be an integrator that will provide standards, an integration test centre and the onboard/offboard system development. The focus will be around the T26/T31 requirements.

PODS primary focus will be on equipment, policy (standards), communications and logistics/ infrastructure. A secondary focus of PODS will be to demonstrate the ability to blur the boundary between traditionally Maritime or Land/Air based capabilities. The PODS will house assets which are vital to supporting Royal Navy operations. These may include an autonomous boat for surveillance and reconnaissance, quadcopter drones to deliver supplies, humanitarian aid and disaster relief stores or medical equipment. Hopefully by being versatile in their approach, they have the capacity to become an additional medical room for service personnel at sea or a control centre for Royal Marines' operations.

Delivered using innovative technology such as heavy lift drones or autonomous boats, a ship will be able to receive the equipment it needs to be re tasked quicker without the need to go into a port to collect it.

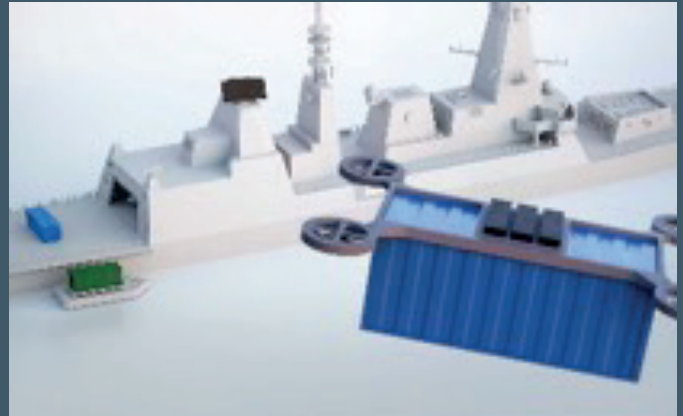



Multi Domain Integration ²⁴

The Maritime Force is intrinsically multi-domain already, delivering routinely across the air, surface, sub-surface, and land domains whilst also undertaking Defence diplomacy tasks. Interoperability across all these domains will be greatly enhanced through the adoption of an increasingly modular approach, directly supporting the Core Tenets of MDI.

- **Information Advantage.** Modular systems able to perform the sense, understand, and decide functions supported by a digital backbone, can be deployed, integrated, and employed across the maritime force from all domains.
- **Strategically postured.** Pan domain interoperable modularity increases the ability to have the right capabilities in the right place at the right time.
- **Configured for the environments.** An adaptable modular maritime force will be enabled for the environment with the optimum capability.
- **Creating and exploiting synergy.** A modular maritime force is more able to adapt to the changing strategic environment alongside joint capabilities.

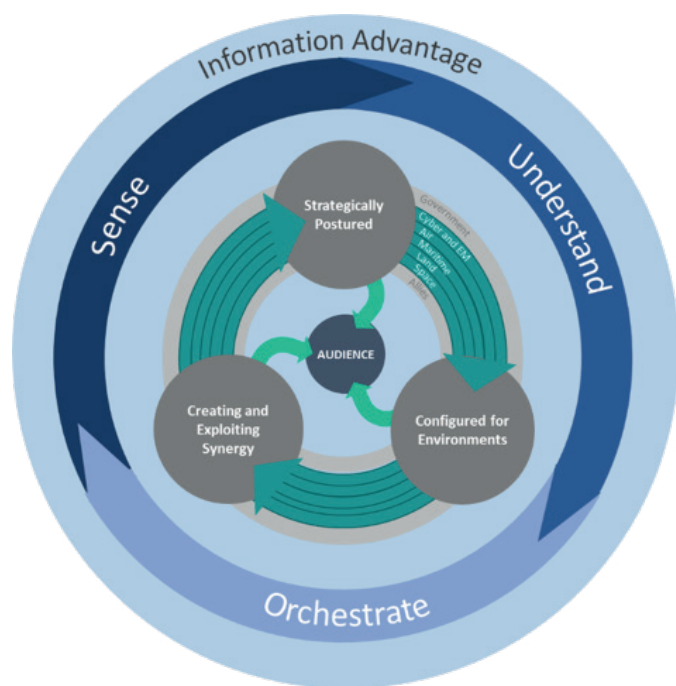

24 JCN 1/20 – Multi-Domain Integration.



Defence Lines of Development Considerations

Pan DLOD integration of any modular capability will increasingly be critical to the operational effectiveness of the Maritime Force. The following, whilst not an exhaustive list, gives some considerations for the development of Maritime Modular Capabilities.

Training

- Consideration whether to pre-train the core complement or deploy trained teams with the capability.
- Modular Capabilities need a shore base training establishment for specialist training. Maintaining a suitable level of skill when not embarked is essential.
- Operating in a modular manner requires an adaptable mindset amongst personnel that needs to be designed into individual training from day one and built upon through career.
- The use of modules ashore, coupled with synthetic training, will be central to many of these considerations.

Equipment

- Standardisation to ensure compatible systems is absolutely critical for the success of Maritime Modularity.
- Discrete, Scalable, Available, Reusable and Integrated; the principles of modularity should be used to guide equipment procurement.

Personnel

- Opportunities exist to improve Availability, Sustainability, Lethality and Lived Experience (ASL/LE) of the workforce through adaptable crewing and Mission/Combat Teams.
- Increasing modularity does not necessarily result in smaller crew requirements. The adverse effects of lean models on crew fatigue are continually under-estimated.
- Modular units need a shore base to provide a 'home' for personnel with meaningful employment opportunities and career management.

Infrastructure

- The effect of embarking modular capabilities on platform performance should be a design consideration on every future maritime platform.
- Installation and removal process should be simplified as far as possible to increase the speed at which capabilities can be switched.
- Weapon and sensor alignment should not be underestimated, and solutions should be found to make this quick and simple to support speed of installation and operational adaptability.

Doctrine/Concepts

- Operating a modular Maritime Force requires an adaptable mindset amongst personnel at all levels and a cultural change in how we plan, schedule, deploy and operate. SOPs, doctrine and concepts should all be adapted appropriately.
- A modular force will be much better suited to experimentation, pushing this further into the deployed and operational experimentation space.

Organisation

- As modular capabilities increase in quantity the Fleet Mix will change. Just as the Maritime Force is designed to be adaptable, the Fleet Mix should be allowed to adapt as new technology is introduced and modularity increases.

Information

- Common standards for key interfaces and communication are critical.
- Speed of integration into the ship and task group as a system of systems should be a key requirement in all modularity.
- Interfaces must be rigidly designed at the beginning of the development process and tightly controlled across the force to ensure compatibility with all platforms and combat systems.

Logistics

- Logistics and infrastructure will be critical to the effective management, movement, maintenance, storage, protection and deployment of containerised capabilities.
- Transportation of capabilities and personnel will need careful management and scheduling to maintain the required readiness for their specialist mission sets.
- Modular capabilities at home, stored forward, or in use on platforms will all require maintenance and engineering support that could increase personnel and resource requirements.





HMS PROTECTOR

The Navy's most modular vessel? The Ice Patrol Ship has over 30 spaces for carriage of ISO containers. As a Ship Taken Up from Trade (STUFT), modular, container solutions have been used to provide military capability for PROTECTOR's Persistent Engagement role. These include weapons workshops, fridge spaces, medical and polar survival stores, magazines, gym equipment, ICT and Main Communications Office facilities.



